

SPECIFICATION

- Part No. : **GSA.8821.B.301111**
- Product Name : I-Bar Penta-Band Cellular Antenna
GSM/CDMA/PCS/DCS/UMTS/WCDMA
- Description : Penta-Band Cellular
GSM/CDMA/PCS/DCS/UMTS/WCDMA
Low Profile
Customizable Cable and Connector
RoHS Compliant



1. Introduction

GSA.8821 I-Bar Penta-band Cellular Antenna is flexible and robust. The slim-line designed for covert and convenient installation in automotive vehicles.

Its omni-directional gain across all bands ensures constant reception and transmission. This dipole antenna is designed to be mounted on glass or plastic (not on metal). Cables and connectors are fully customizable. It comes with strong 3M double-sided adhesive for a permanent and secure fix to your vehicle interior.

2. Specification

ELECTRICAL						
System		AMPS	GSM	DCS	PCS	UMTS
Band (MHz)		824-896	880-960	1710-1880	1850-1990	1710-2170
Free Space Return Loss (dB)						
Cable length (meter)	3.0	-7.8	-8.5	-9.2	-13.6	-16.0
	2.0	-6.3	-6.6	-6.5	-9.5	-11.2
	1.0	-4.7	-5.4	-4.7	-10.1	-10.1
	0.5	-3.8	-3.9	-3.6	-10.1	-10.0
Free Space Peak Gain (dBi)						
Cable length (meter)	3.0	-5.1	-1.6	-2.7	-2.7	-2.7
	2.0	-1.2	1.3	2.2	2.2	2.2
	1.0	1.8	1.8	1.9	2.7	2.7
	0.5	-0.5	2.6	1.8	2.8	2.8
Free Space Efficiency (%)						
Cable length (meter)	3.0	7%	20%	12%	15%	12%
	2.0	24%	45%	28%	37%	32%
	1.0	42%	46%	41%	52%	44%
	0.5	35%	59%	40%	53%	45%
Polarization	Linear					
Impedance	50 ohms					
Input Power	10W max					
MECHANICAL						
Dimensions	106.7 x 14.7 x 5.3mm					
Cable	RG 174 Standard, Fully customizable					
Connector	SMA (M) Standard, Fully customizable					
Casing	UV Resistant TPE					
Weight	40g					
ENVIRONMENTAL						
Waterproof	IP65					
Temperature Range	-40°C to +105°C					
Thermal Shock	100 cycles -40°C to +85°C					
Humidity	Non-condensing 65°C 95% RH					
Shock (Drop Test)	1m drop on concrete 6 axes					
Cable Pull	8kgf					

* Electrical properties are measurement of GSA.8821 with 3m RG174 SMA(M) in free space.

3. S11 Property of GSA.8821 (with RG.174 Cable)

3.1. Free Space Return Loss

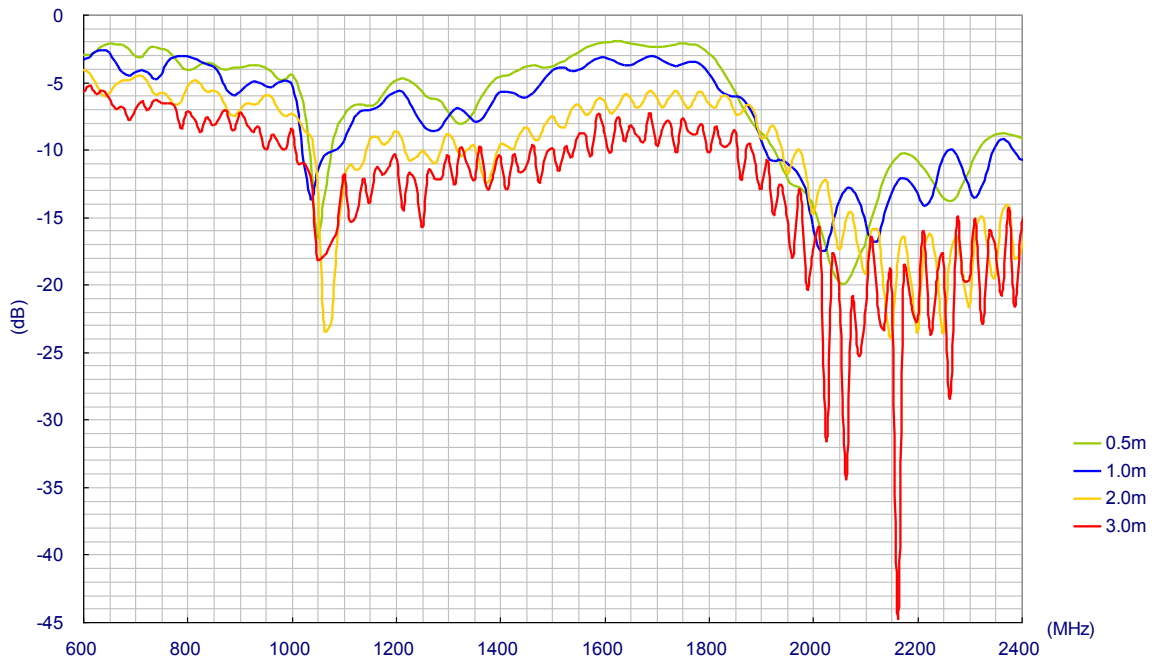

3.2. Return Loss of GSA.8821 Mounted on Glass

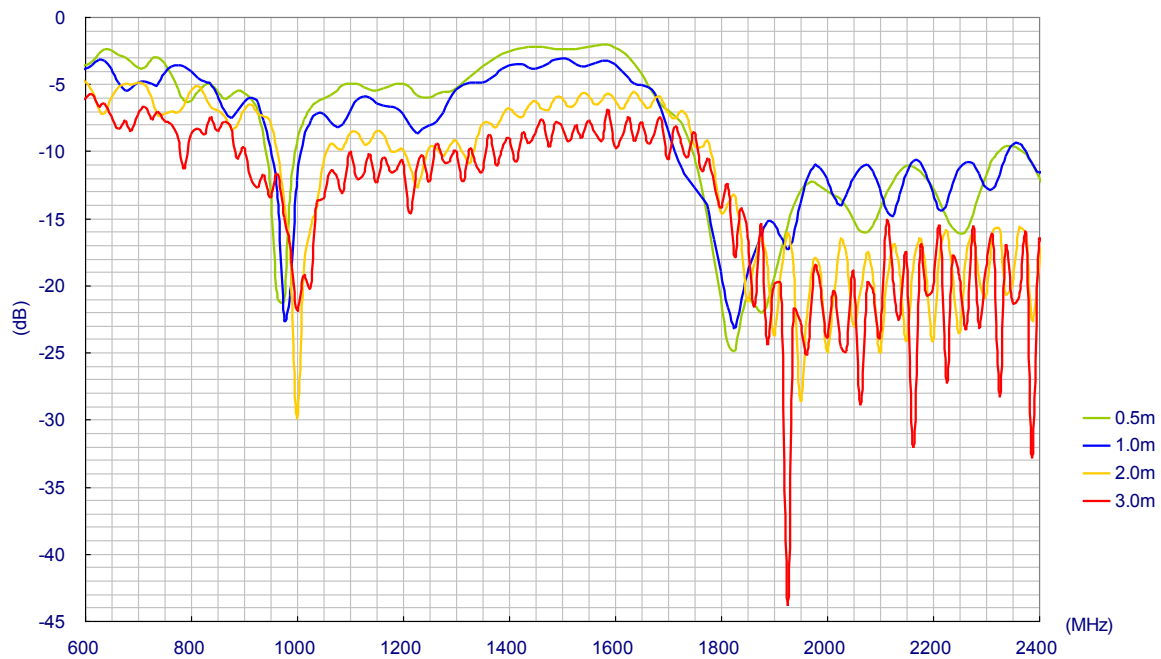

3.3. Return Loss of GSA.8821 Mounted on ABS

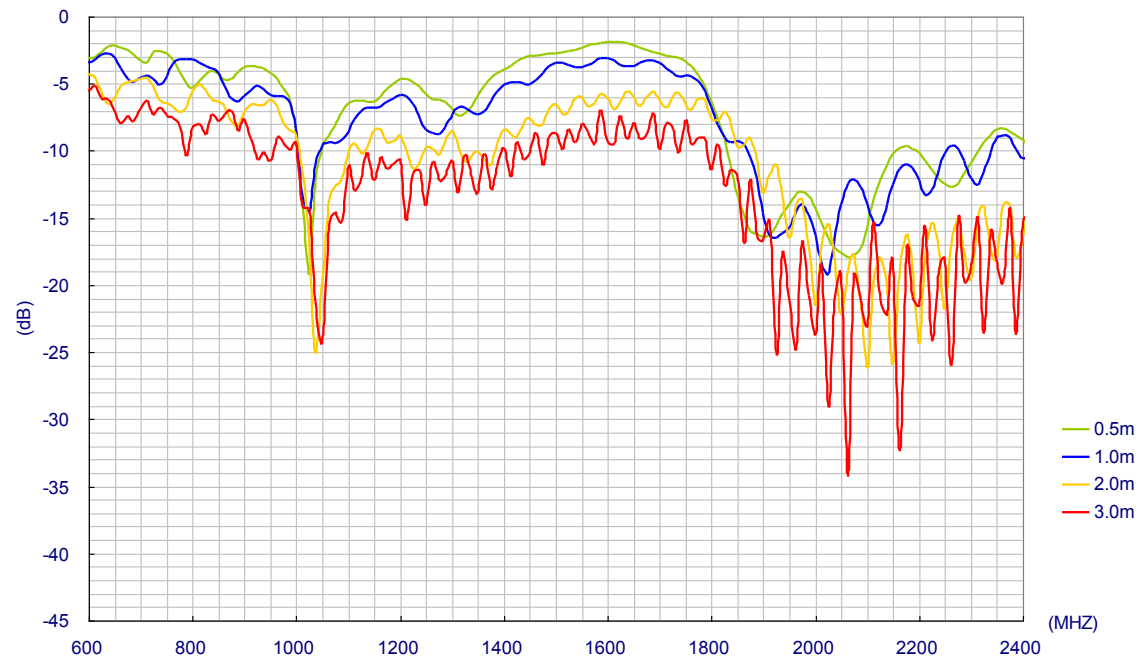

4. Free Space Antenna 3D Radiation Property

4.1. Efficiency of GSA.8821 with RG.174 Cable

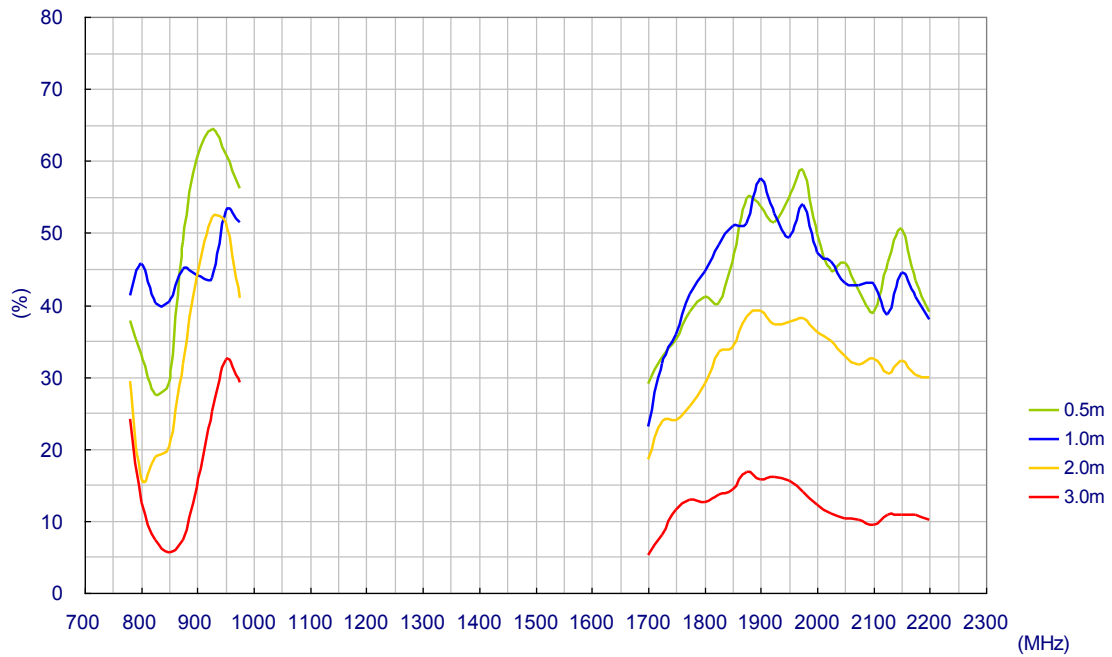

4.2. Efficiency of GSA.8821 (with 3M RG-174 960~1700MHz)

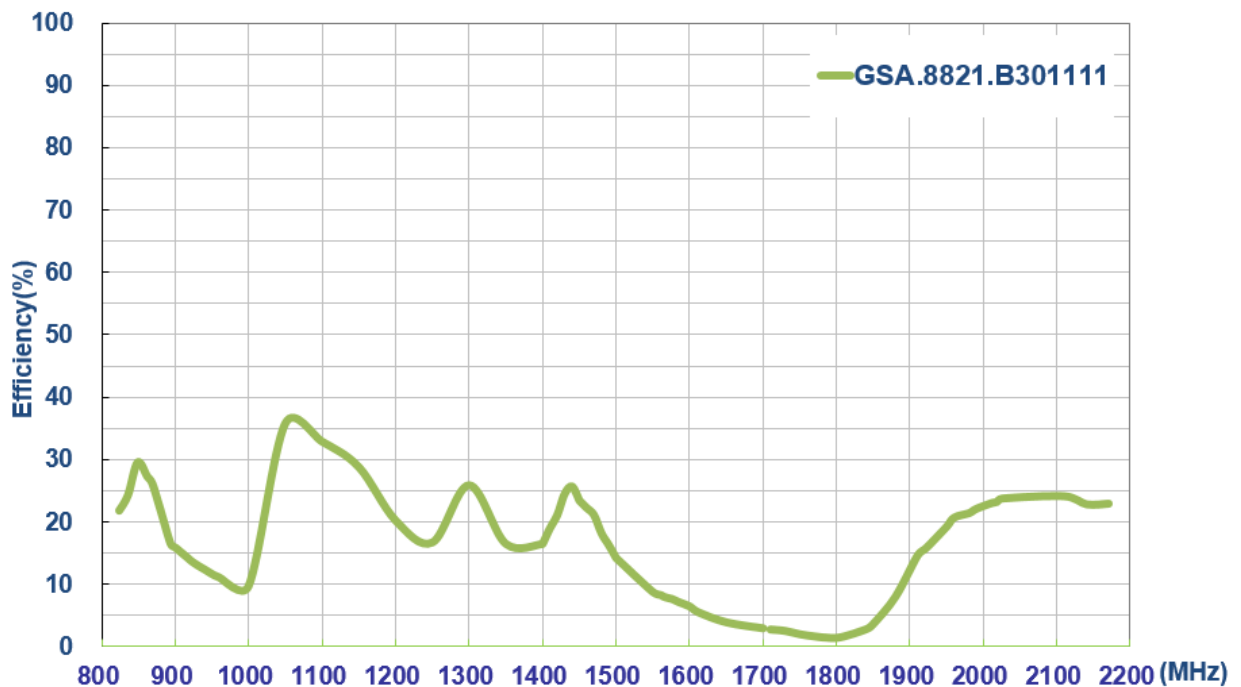

4.3. Peak Gain of GSA.8821 with RG.174 Cable

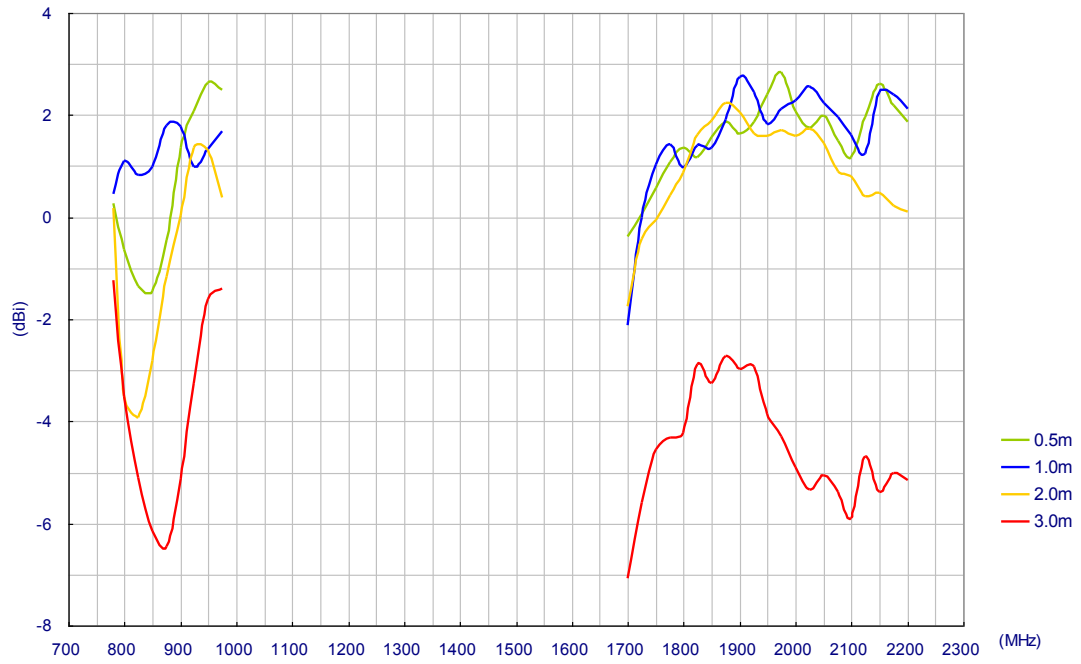

4.4. Peak Gain of GSA.8821 (with 3M RG-174 960~1700MHz)

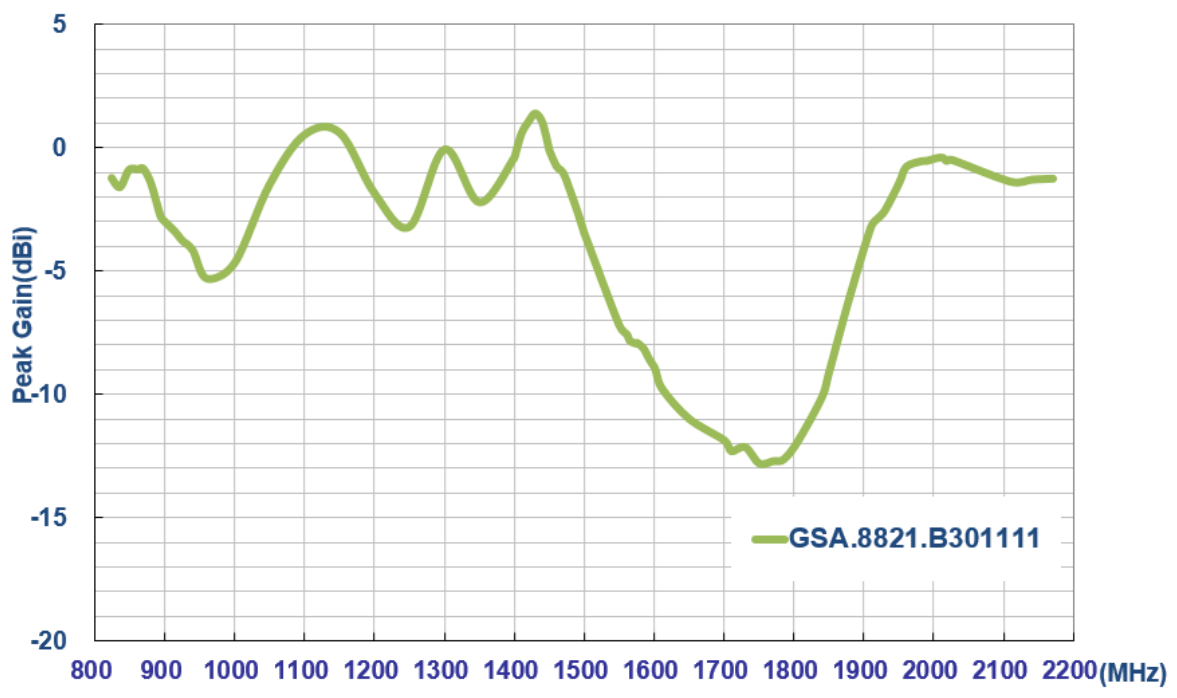

4.5. Average Gain of GSA.8821 (with RG.174 Cable)

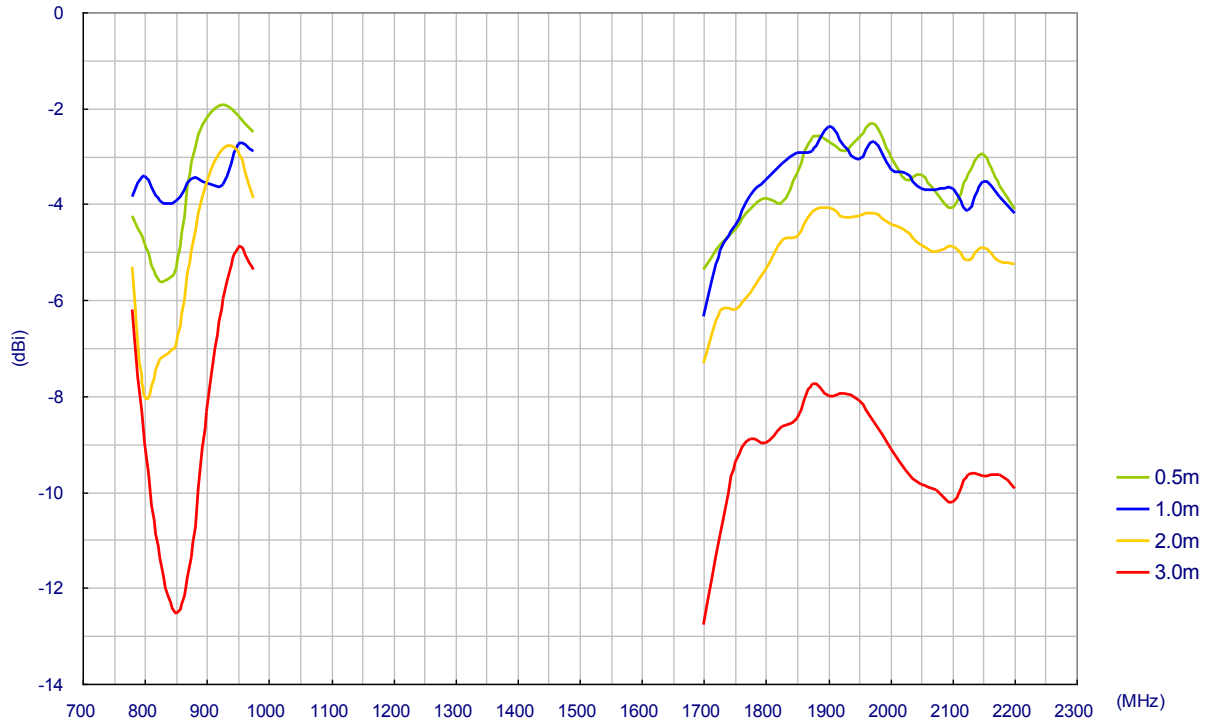

5. Radiation Pattern

5.1. Horizontal H-Plane (Radiation of GSA.8821 with 0.5m RG.174 Cable)

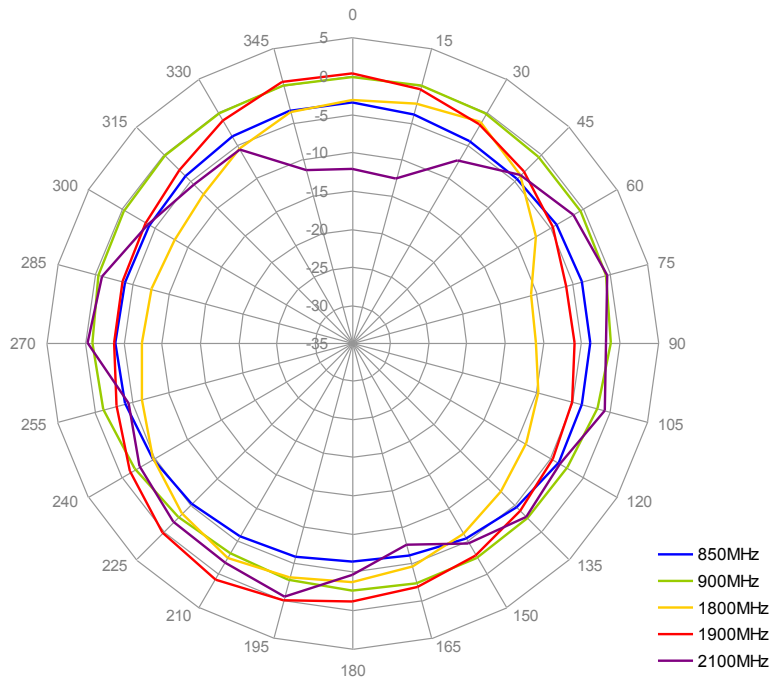

5.2. Vertical E-Plane (Radiation of GSA.8821 with 0.5m RG.174 Cable)

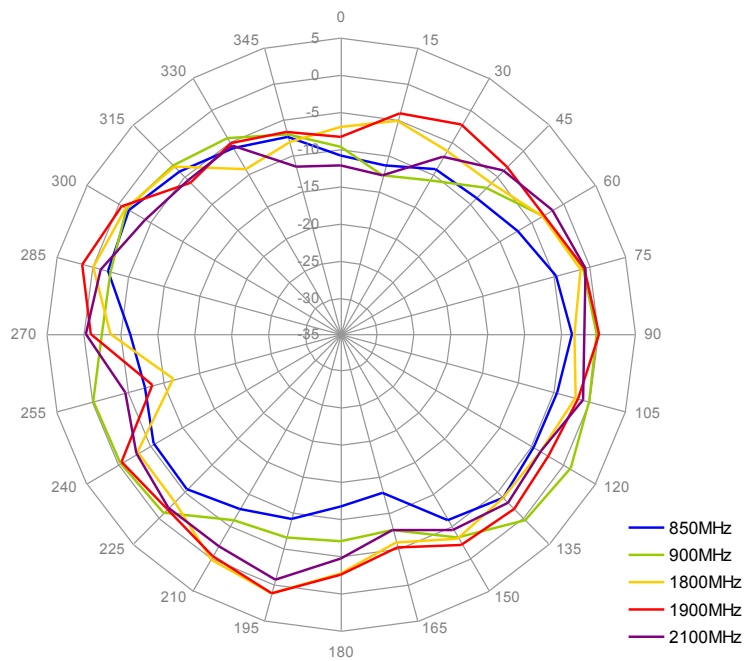

5.3. Horizontal H-Plane (Radiation of GSA.8821 with 1.0m RG.174 Cable)

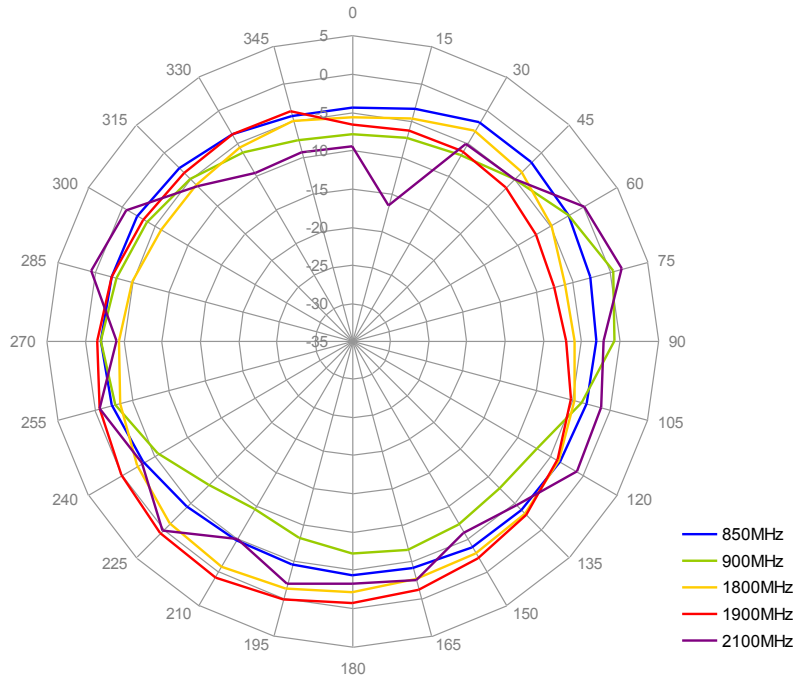

5.4. Vertical E-Plane (Radiation of GSA.8821 with 1.0m RG.174 Cable)

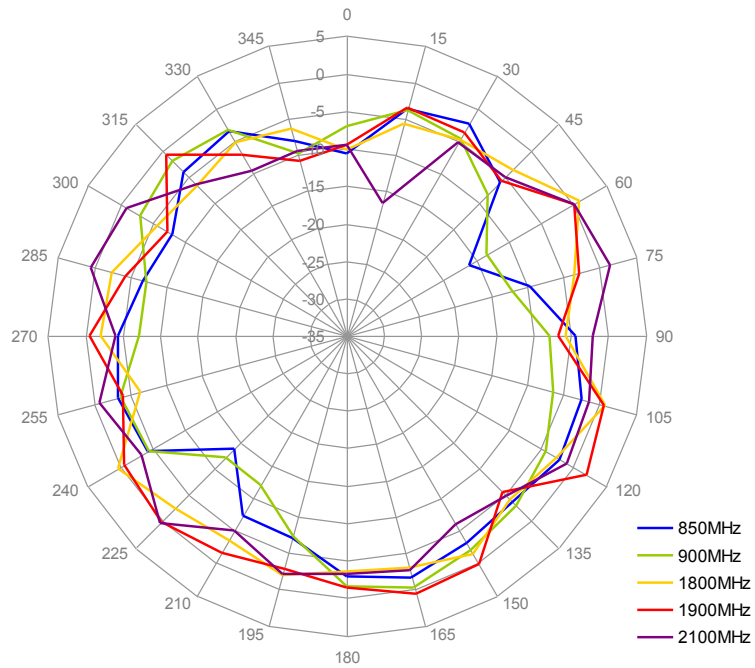

5.5. Horizontal H-Plane (Radiation of GSA.8821 with 2.0m RG.174 Cable)

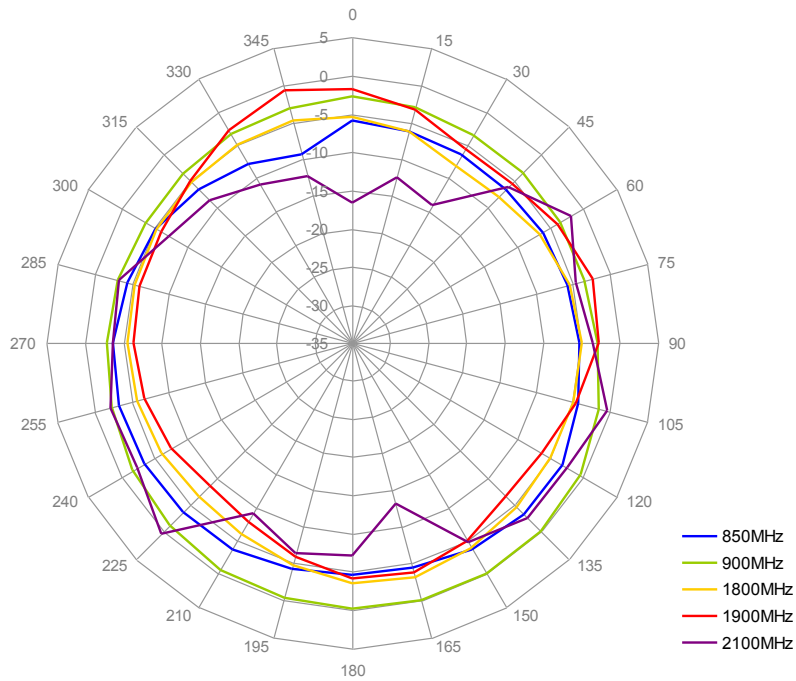

5.6. Vertical E-Plane (Radiation of GSA.8821 with 2.0m RG.174 Cable)

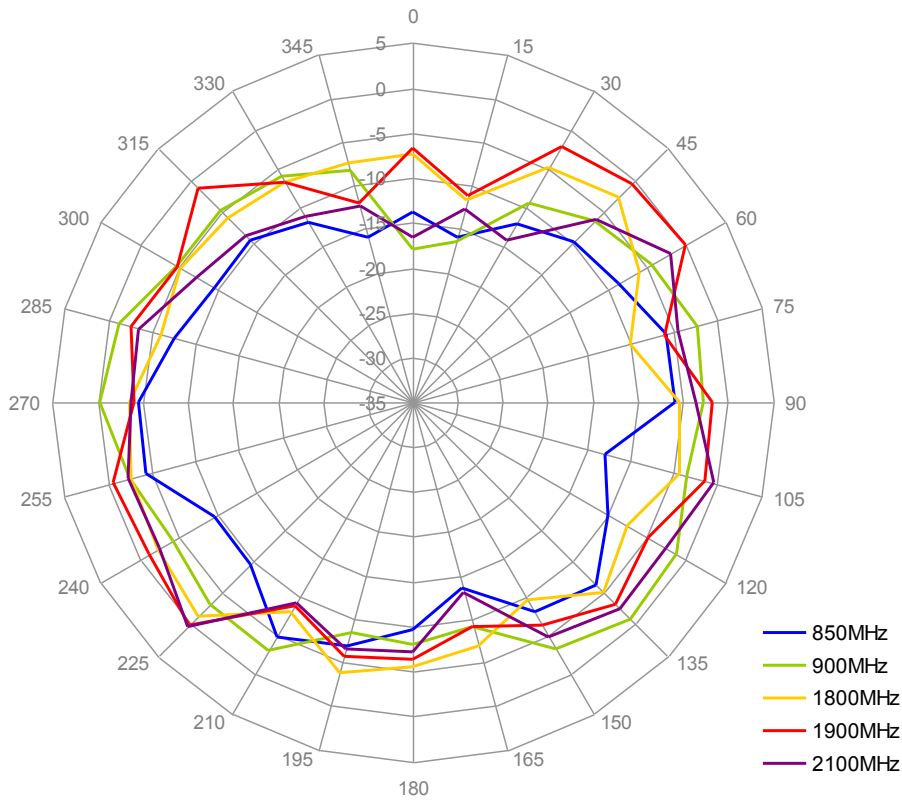

5.7. Horizontal H-Plane (Radiation of GSA.8821 with 3.0m RG.174 Cable)

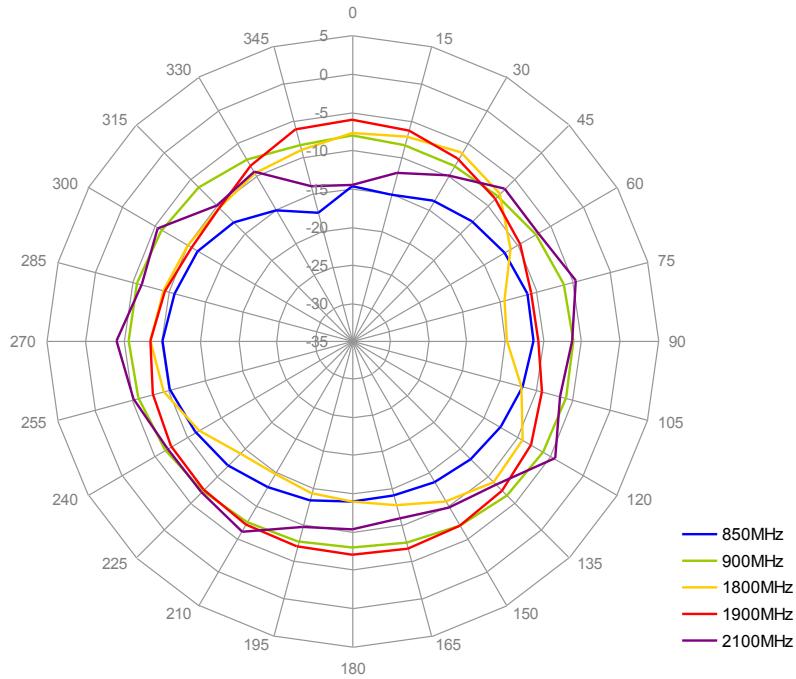

5.8. Vertical E-Plane (Radiation of GSA.8821 with 3.0m RG.174 Cable)

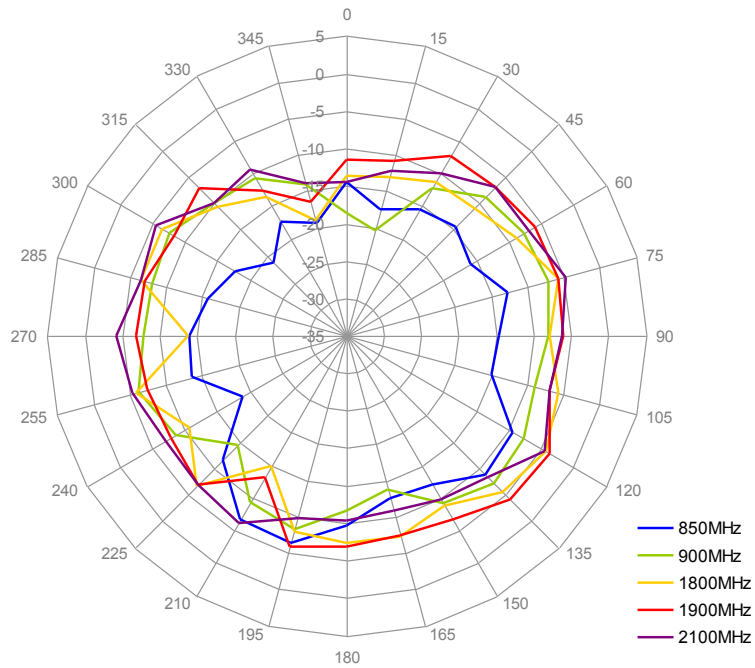

6. Mechanical Drawing (Unit: mm)

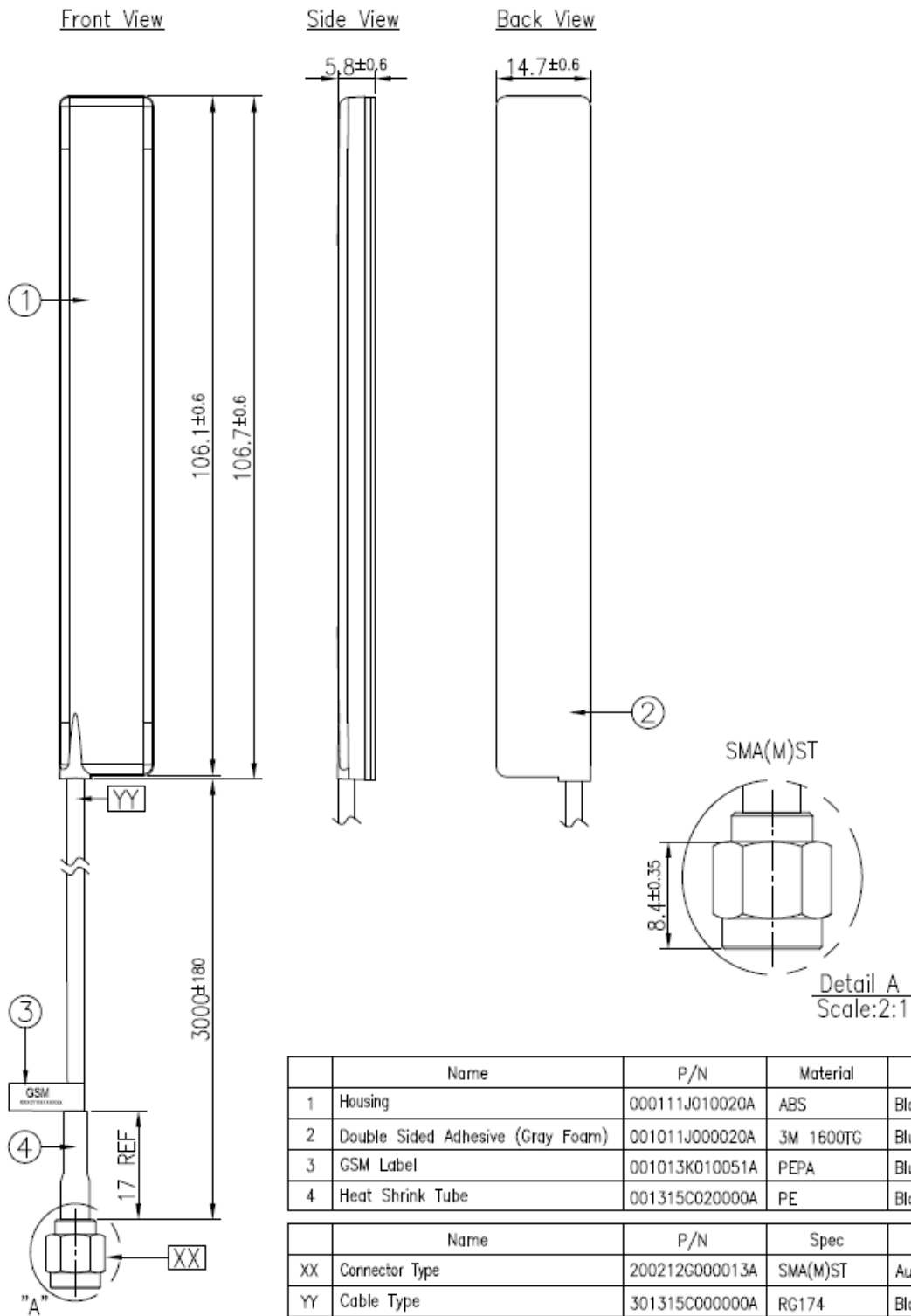

7. Packaging

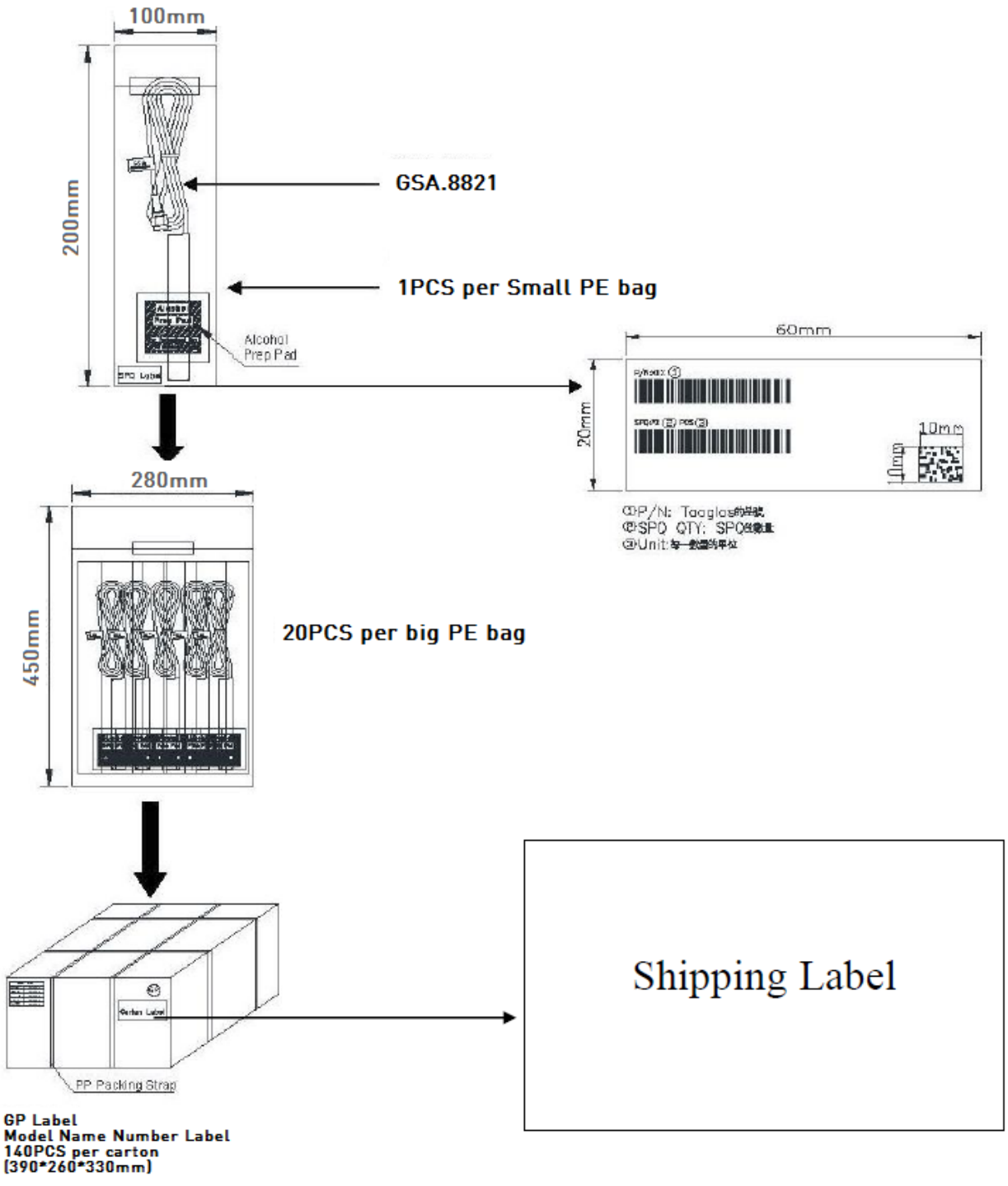



Taoglas makes no warranties based on the accuracy or completeness of the contents of this document and reserves the right to make changes to specifications and product descriptions at any time without notice. Taoglas reserves all rights to this document and the information contained herein.

Reproduction, use or disclosure to third parties without express permission is strictly prohibited.

Copyright © Taoglas Ltd.

Mouser Electronics

Authorized Distributor

Click to View Pricing, Inventory, Delivery & Lifecycle Information:

[Taoglas:](#)

[GSA.8821.B301111](#)