

74LVC1G99

Ultra-configurable multiple function gate; 3-state

Rev. 10.1 — 22 October 2018

Product data sheet

1. General description

The 74LVC1G99 provides a low voltage, ultra-configurable, multiple function gate with 3-state output. The device can be configured as one of several logic functions including, AND, OR, NAND, NOR, XOR, XNOR, inverter, buffer and MUX. No external components are required to configure the device as all inputs can be connected directly to V_{CC} or GND. The 3-state output is controlled by the output enable input (\overline{OE}). A HIGH level at \overline{OE} causes the output (Y) to assume a high-impedance OFF-state. When \overline{OE} is LOW, the output state is determined by the signals applied to the Schmitt trigger inputs (A, B, C and D).

Due to the use of Schmitt trigger inputs the device is tolerant of slowly changing input signals, transforming them into sharply defined, jitter free output signals. By eliminating leakage current paths to V_{CC} and GND, the inputs and disabled output are also over-voltage tolerant, making the device suitable for mixed-voltage applications.

This device is fully specified for partial power-down applications using I_{OFF} . The I_{OFF} circuitry disables the output, preventing the damaging backflow current through the device when it is powered down.

The 74LVC1G99 is fully specified over the supply range from 1.65 V to 5.5 V.

2. Features and benefits

- Wide supply voltage range from 1.65 V to 5.5 V
- 5 V tolerant inputs for interfacing with 5 V logic
- High noise immunity
- Complies with JEDEC standard:
 - JESD8-7 (1.65 V to 1.95 V)
 - JESD8-5 (2.3 V to 2.7 V)
 - JESD8-B/JESD36 (2.7 V to 3.6 V)
- ESD protection:
 - HBM JESD22-A114F exceeds 2000 V
 - MM JESD22-A115-A exceeds 200 V
- ± 24 mA output drive ($V_{CC} = 3.0$ V)
- CMOS low power consumption
- Latch-up performance exceeds 250 mA
- Direct interface with TTL levels
- Inputs accept voltages up to 5 V
- Multiple package options
- Specified from -40 °C to $+85$ °C and -40 °C to $+125$ °C.

3. Ordering information

Table 1. Ordering information

Type number	Package			Version
	Temperature range	Name	Description	
74LVC1G99DP	-40 °C to +125 °C	TSSOP8	plastic thin shrink small outline package; 8 leads; body width 3 mm; lead length 0.5 mm	SOT505-2
74LVC1G99GT	-40 °C to +125 °C	XSON8	plastic extremely thin small outline package; no leads; 8 terminals; body 1 × 1.95 × 0.5 mm	SOT833-1
74LVC1G99GF	-40 °C to +125 °C	XSON8	extremely thin small outline package; no leads; 8 terminals; body 1.35 × 1 × 0.5 mm	SOT1089
74LVC1G99GM	-40 °C to +125 °C	XQFN8	plastic, extremely thin quad flat package; no leads; 8 terminals; body 1.6 × 1.6 × 0.5 mm	SOT902-2
74LVC1G99GN	-40 °C to +125 °C	XSON8	extremely thin small outline package; no leads; 8 terminals; body 1.2 × 1.0 × 0.35 mm	SOT1116
74LVC1G99GS	-40 °C to +125 °C	XSON8	extremely thin small outline package; no leads; 8 terminals; body 1.35 × 1.0 × 0.35 mm	SOT1203

4. Marking

Table 2. Marking codes

Type number	Marking code [1]
74LVC1G99DP	V99
74LVC1G99GT	V99
74LVC1G99GF	YF
74LVC1G99GM	V99
74LVC1G99GN	YF
74LVC1G99GS	YF

[1] The pin 1 indicator is located on the lower left corner of the device, below the marking code.

5. Functional diagram

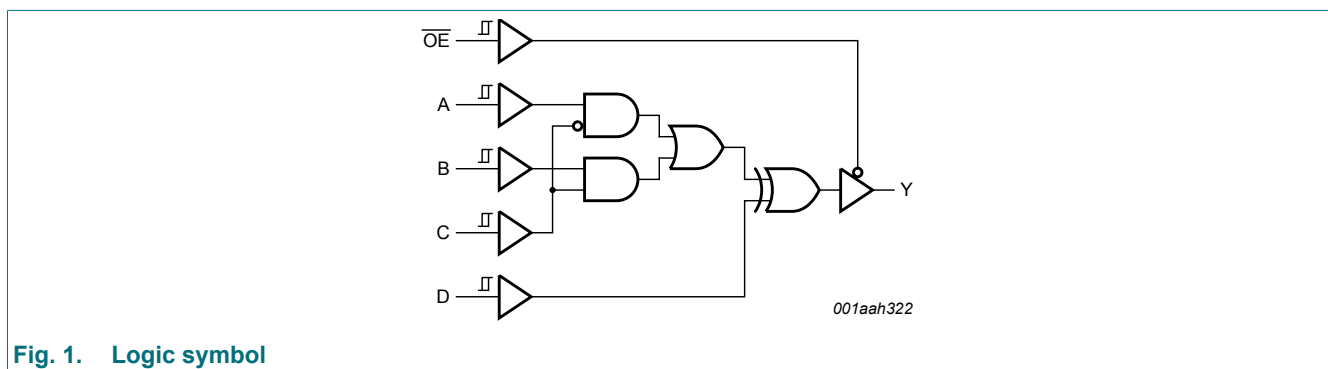

Fig. 1. Logic symbol

6. Pinning information

6.1. Pinning

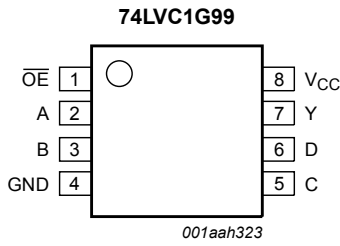

Fig. 2. Pin configuration SOT505-2 (TSSOP8)

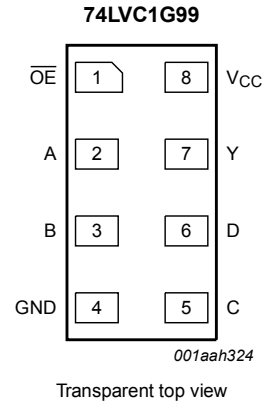

Fig. 3. Pin configuration SOT833-1, SOT1089, SOT1116 and SOT1203 (XSON8)

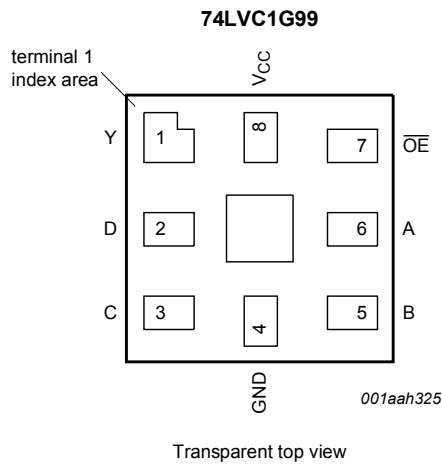

Fig. 4. Pin configuration SOT902-2 (XQFN8)

6.2. Pin description

Table 3. Pin description

Symbol	Pin		Description
	SOT505-2, SOT833-1, SOT1089, SOT1116 and SOT1203	SOT902-2	
OE	1	7	output enable input OE (active LOW)
A	2	6	data input
B	3	5	data input
GND	4	4	ground (0 V)
C	5	3	data input
D	6	2	data input
Y	7	1	data output
VCC	8	8	supply voltage

7. Functional description

Table 4. Function table

H = HIGH voltage level; L = LOW voltage level; X = don't care; Z = high-impedance OFF-state.

Input					Output
OE	D	C	B	A	Y
L	L	L	L	L	L
L	L	L	L	H	H
L	L	L	H	L	L
L	L	L	H	H	H
L	L	H	L	L	L
L	L	H	L	H	L
L	L	H	H	L	H
L	L	H	H	H	H
L	H	L	L	L	H
L	H	L	L	H	L
L	H	L	H	L	H
L	H	L	H	H	L
L	H	H	L	L	H
L	H	H	L	H	H
L	H	H	H	L	L
L	H	H	H	H	L
H	X	X	X	X	Z

7.1. Logic configurations

Table 5. Function selection table

Primary function	Complementary function
3-state buffer	
3-state inverter	
3-state 2-input multiplexer	
3-state 2-input multiplexer with inverting output	
3-state 2-input AND	3-state 2-input NOR with two inverting inputs
3-state 2-input AND with one inverting input	3-state 2-input NOR with one inverting input
3-state 2-input AND with two inverting inputs	3-state 2-input NOR
3-state 2-input NAND	3-state 2-input OR with two inverting inputs
3-state 2-input NAND with one inverting input	3-state 2-input OR with one inverting input
3-state 2-input NAND with two inverting inputs	3-state 2-input OR
3-state 2-input XOR	
3-state 2-input XNOR	3-state 2-input XOR with one inverting input

7.2. 3-state buffer functions available

Table 6. Function table

H = HIGH voltage level; L = LOW voltage level; See Fig. 5.

Function	Input				
	OE	A	B	C	D
3-state buffer	L	input	H or L	L	L
	L	H or L	input	H	L
	L	L	H	input	L
	L	H	L	input	H
	L	H	H or L	L	input
	L	H or L	L	H	input
	L	L	L	H or L	input

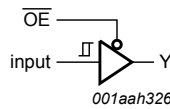

Fig. 5. 3-state buffer function

7.3. 3-state inverter functions available

Table 7. Function table

H = HIGH voltage level; L = LOW voltage level; X = don't care. See Fig. 6.

Function	Input				
	OE	A	B	C	D
3-state inverter	L	input	H or L	L	H
	L	X	input	H	H
	L	L	H	input	H
	L	H	L	input	L
	L	H	H or L	L	input
	L	H or L	H	H	input
	L	H	H	H or L	input

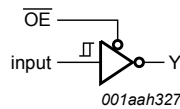

Fig. 6. 3-state inverter function

7.4. 3-state multiplexer functions available

Table 8. Function table

H = HIGH voltage level; L = LOW voltage level. See Fig. 7.

Function	Input				
	OE	A	B	C	D
3-state 2-input multiplexer	L	input 1	input 2	input 1 or input 2	L
	L	input 2	input 1	input 2 or input 1	L
	L	input 1	input 2	input 1 or input 2	H
	L	input 2	input 1	input 2 or input 1	H

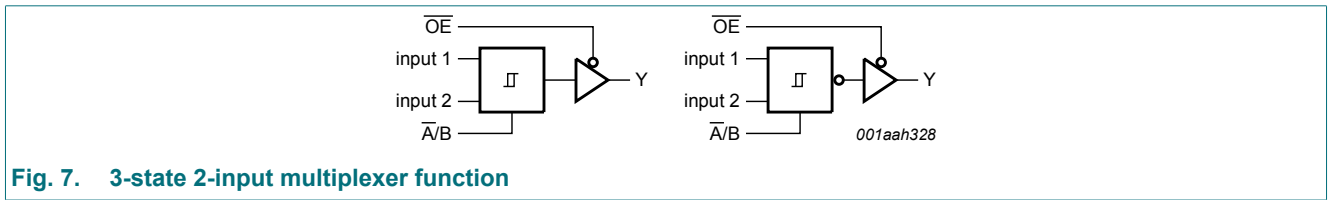

Fig. 7. 3-state 2-input multiplexer function

7.5. 3-state AND/NOR functions available

Table 9. Function table

H = HIGH voltage level; L = LOW voltage level. See Fig. 8.

Number of inputs	Function		Input				
	AND/NAND	OR/NOR	OE	A	B	C	D
2	3-state AND	3-state NOR	L	L	input 1	input 2	L
2	3-state AND	3-state NOR	L	L	input 2	input 1	L

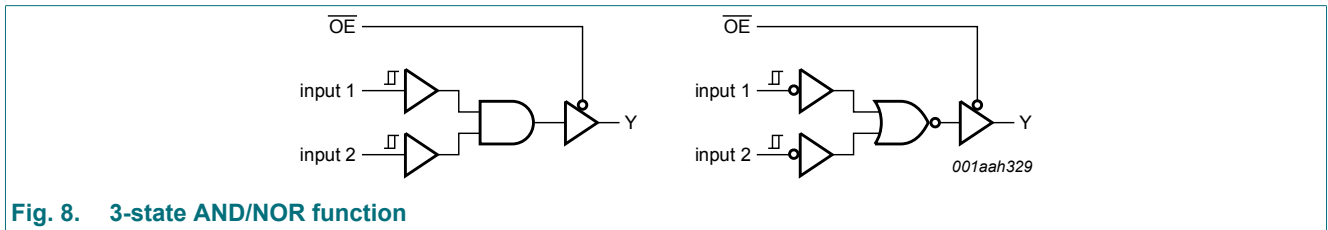

Fig. 8. 3-state AND/NOR function

Table 10. Function table

H = HIGH voltage level; L = LOW voltage level. See Fig. 9.

Number of inputs	Function		Input				
	AND/NAND	OR/NOR	OE	A	B	C	D
2	3-state AND	3-state NOR	L	input 2	L	input 1	L
2	3-state AND	3-state NOR	L	H	input 1	input 2	H

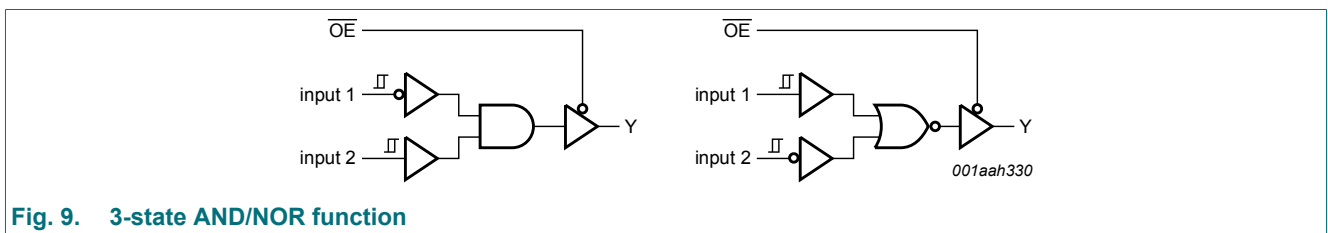

Fig. 9. 3-state AND/NOR function

Table 11. Function table

H = HIGH voltage level; L = LOW voltage level. See Fig. 10.

Number of inputs	Function		Input				
	AND/NAND	OR/NOR	\overline{OE}	A	B	C	D
2	3-state AND	3-state NOR	L	input 1	L	input 2	L
2	3-state AND	3-state NOR	L	H	input 2	input 1	H

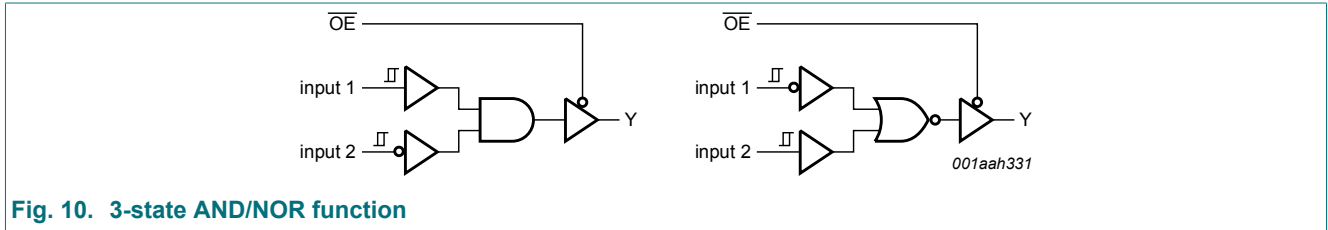

Fig. 10. 3-state AND/NOR function

Table 12. Function table

H = HIGH voltage level; L = LOW voltage level. See Fig. 11.

Number of inputs	Function		Input				
	AND/NAND	OR/NOR	\overline{OE}	A	B	C	D
2	3-state AND	3-state NOR	L	input 1	H	input 2	H
2	3-state AND	3-state NOR	L	input 2	H	input 1	H

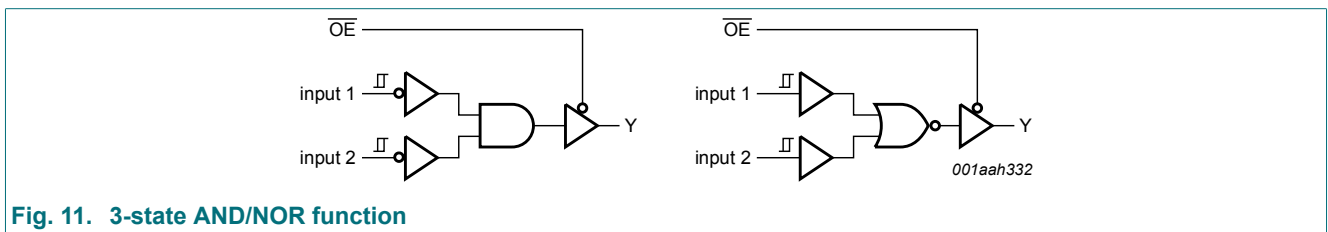

Fig. 11. 3-state AND/NOR function

7.6. 3-state NAND/OR functions available

Table 13. Function table

H = HIGH voltage level; L = LOW voltage level. See Fig. 12.

Number of inputs	Function		Input				
	AND/NAND	OR/NOR	\overline{OE}	A	B	C	D
2	3-state NAND	3-state OR	L	L	input 1	input 2	H
2	3-state NAND	3-state OR	L	L	input 2	input 1	H

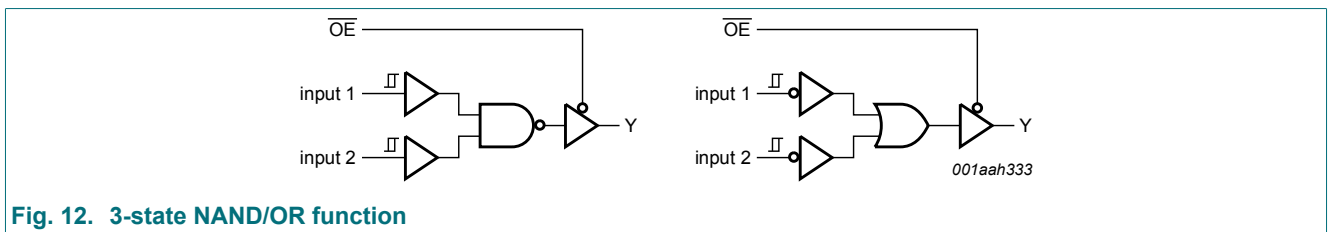

Fig. 12. 3-state NAND/OR function

Table 14. Function table

H = HIGH voltage level; L = LOW voltage level. See Fig. 13.

Number of inputs	Function		Input				
	AND/NAND	OR/NOR	\overline{OE}	A	B	C	D
2	3-state NAND	3-state OR	L	input 2	L	input 1	H
2	3-state NAND	3-state OR	L	H	input 1	input 2	L

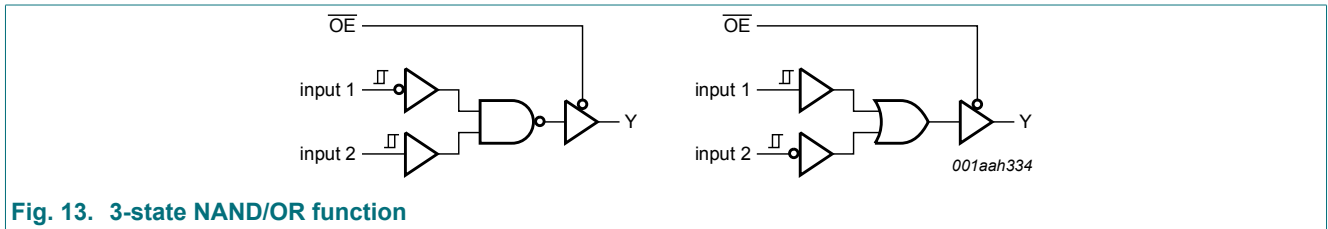

Fig. 13. 3-state NAND/OR function

Table 15. Function table

H = HIGH voltage level; L = LOW voltage level. See Fig. 14.

Number of inputs	Function		Input				
	AND/NAND	OR/NOR	\overline{OE}	A	B	C	D
2	3-state NAND	3-state OR	L	input 1	L	input 2	H
2	3-state NAND	3-state OR	L	H	input 2	input 1	L

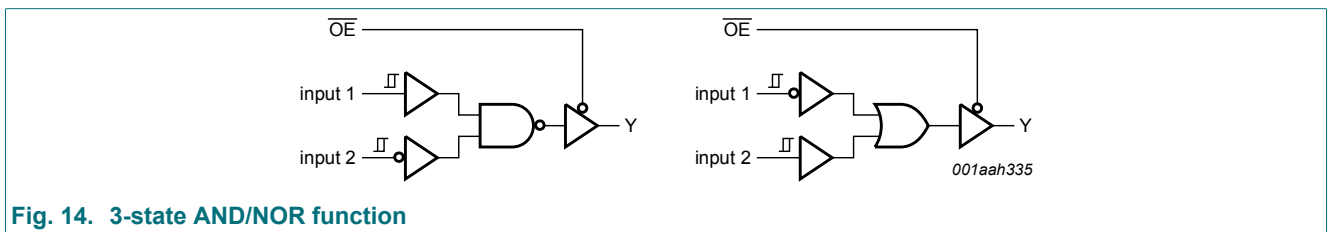

Fig. 14. 3-state AND/NOR function

Table 16. Function table

H = HIGH voltage level; L = LOW voltage level. See Fig. 15.

Number of inputs	Function		Input				
	AND/NAND	OR/NOR	\overline{OE}	A	B	C	D
2	3-state NAND	3-state OR	L	input 1	H	input 2	L
2	3-state NAND	3-state OR	L	input 2	H	input 1	L

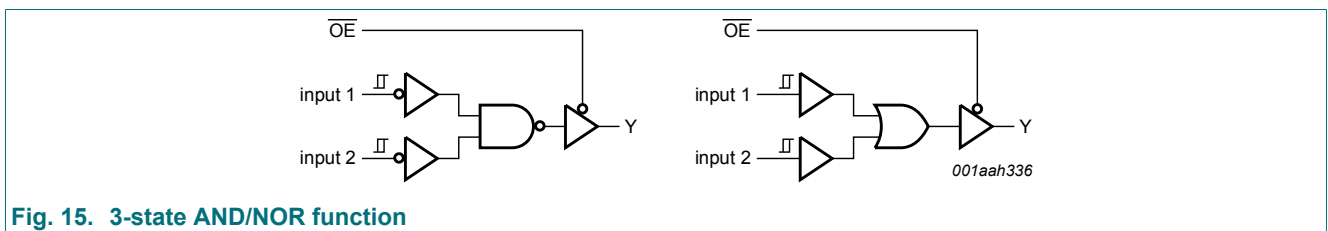

Fig. 15. 3-state AND/NOR function

7.7. 3-state XOR/XNOR functions available

Table 17. Function table

H = HIGH voltage level; L = LOW voltage level. See Fig. 16.

Function	Input				
	OE	A	B	C	D
3-state XOR	L	input 1	H or L	L	input 2
	L	input 2	H or L	L	input 1
	L	H or L	input 1	H	input 2
	L	H or L	input 2	H	input 1
	L	L	H	input 1	input 2
	L	L	H	input 2	input 1

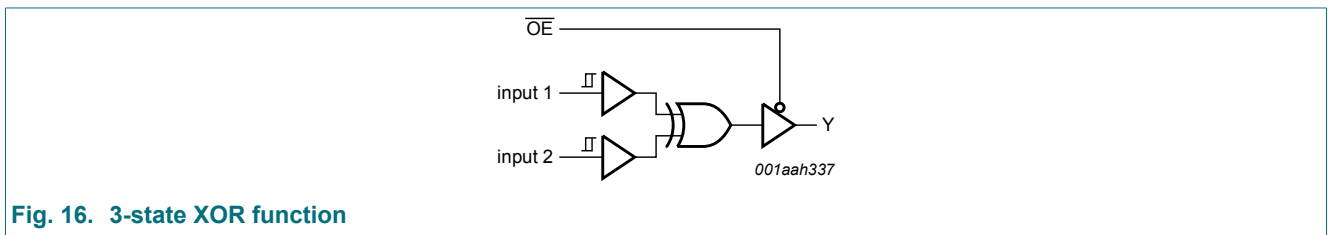

Fig. 16. 3-state XOR function

Table 18. Function table

H = HIGH voltage level; L = LOW voltage level. See Fig. 17.

Function	Input				
	OE	A	B	C	D
3-state XOR	L	H	L	input 1	input 2

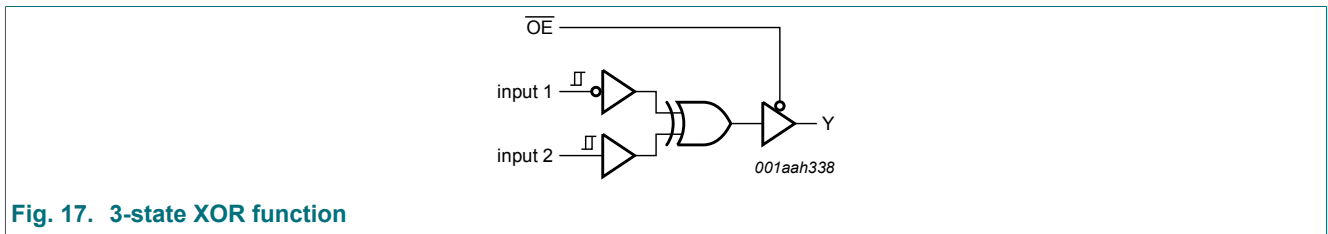

Fig. 17. 3-state XOR function

Table 19. Function table

H = HIGH voltage level; L = LOW voltage level. See Fig. 18.

Function	Input				
	OE	A	B	C	D
3-state XOR	L	H	L	input 1	input 2

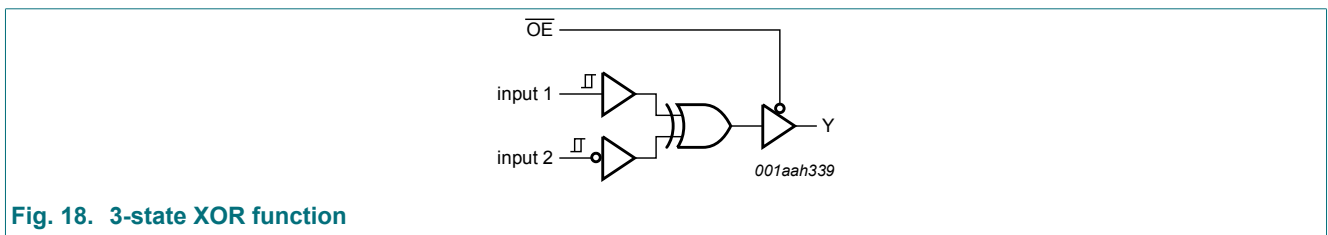

Fig. 18. 3-state XOR function

Table 20. Function table

H = HIGH voltage level; L = LOW voltage level. See Fig. 19.

Function	Input				
	OE	A	B	C	D
3-state XNOR	L	H	L	input 1	input 2
	L	H	L	input 2	input 1

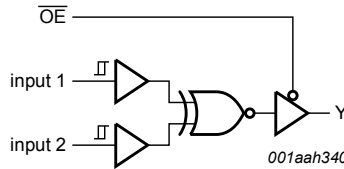

Fig. 19. 3-state XNOR function

8. Limiting values

Table 21. Limiting values

In accordance with the Absolute Maximum Rating System (IEC 60134). Voltages are referenced to GND (ground = 0 V).

Symbol	Parameter	Conditions	Min	Max	Unit
V_{CC}	supply voltage		-0.5	+6.5	V
I_{IK}	input clamping current	$V_I < 0$ V	-50	-	mA
V_I	input voltage		[1] -0.5	+6.5	V
I_{OK}	output clamping current	$V_O > V_{CC}$ or $V_O < 0$ V	-	±50	mA
V_O	output voltage	Active mode	[1] -0.5	$V_{CC} + 0.5$	V
		Power-down mode; $V_{CC} = 0$ V	[1] -0.5	+6.5	V
I_O	output current	$V_O = 0$ V to V_{CC}	-	±50	mA
I_{CC}	supply current		-	100	mA
I_{GND}	ground current		-100	-	mA
P_{tot}	total power dissipation	$T_{amb} = -40$ °C to $+125$ °C	[2] -	250	mW
T_{stg}	storage temperature		-65	+150	°C

[1] The input and output voltage ratings may be exceeded if the input and output current ratings are observed.

[2] For TSSOP8 package: above 110 °C the value of P_{tot} derates linearly with 8.0 mW/K.
For XSON8 and XQFN8 packages: above 118 °C the value of P_{tot} derates linearly with 7.8 mW/K.

9. Recommended operating conditions

Table 22. Operating conditions

Symbol	Parameter	Conditions	Min	Max	Unit
V_{CC}	supply voltage		1.65	5.5	V
V_I	input voltage		0	5.5	V
V_O	output voltage	Active mode	0	V_{CC}	V
		Power-down mode; $V_{CC} = 0$ V	0	5.5	V
T_{amb}	ambient temperature		-40	+125	°C
$\Delta t/\Delta V$	input transition rise and fall rate	$V_{CC} = 1.65$ V to 2.7 V	-	20	ns/V
		$V_{CC} = 2.7$ V to 4.5 V	-	10	ns/V
		$V_{CC} = 4.5$ V to 5.5 V	-	5	ns/V

10. Static characteristics

Table 23. Static characteristics

At recommended operating conditions. Voltages are referenced to GND (ground = 0 V).

Symbol	Parameter	Conditions	T _{amb} = -40 °C to +85 °C			T _{amb} = -40 °C to +125 °C		Unit		
			Min	Typ [1]	Max	Min	Max			
V _{OH}	HIGH-level output voltage	V _I = V _{T+} or V _{T-}								
		I _O = -100 μA; V _{CC} = 1.65 V to 5.5 V	V _{CC} - 0.1	-	-	V _{CC} - 0.1	-	V		
		I _O = -4 mA; V _{CC} = 1.65 V	1.2	-	-	0.95	-	V		
		I _O = -8 mA; V _{CC} = 2.3 V	1.9	-	-	1.7	-	V		
		I _O = -12 mA; V _{CC} = 2.7 V	2.2	-	-	1.9	-	V		
		I _O = -24 mA; V _{CC} = 3.0 V	2.3	-	-	2.0	-	V		
V _{OL}	LOW-level output voltage	V _I = V _{T+} or V _{T-}								
		I _O = 100 μA; V _{CC} = 1.65 V to 5.5 V	-	-	0.1	-	0.1	V		
		I _O = 4 mA; V _{CC} = 1.65 V	-	-	0.45	-	0.70	V		
		I _O = 8 mA; V _{CC} = 2.3 V	-	-	0.3	-	0.45	V		
		I _O = 12 mA; V _{CC} = 2.7 V	-	-	0.4	-	0.60	V		
		I _O = 24 mA; V _{CC} = 3.0 V	-	-	0.55	-	0.80	V		
I _I	input leakage current	V _{CC} = 0 V to 5.5 V; V _I = 5.5 V or GND	-	±0.1	±1	-	±1	μA		
		I _{OZ}	OFF-state output current	V _{CC} = 3.6 V; V _I = V _{IH} or V _{IL} ; V _O = 5.5 V or GND	-	±0.1	±2	-	±2	μA
		I _{OFF}	power-off leakage current	V _{CC} = 0 V; V _I or V _O = 5.5 V	-	±0.1	±2	-	±2	μA
		I _{CC}	supply current	V _{CC} = 1.65 V to 5.5 V; V _I = 5.5 V or GND; I _O = 0 A	-	0.1	4	-	4	μA
		ΔI _{CC}	additional supply current	per pin; V _{CC} = 2.3 V to 5.5 V; V _I = V _{CC} - 0.6 V; I _O = 0 A	-	5	500	-	500	μA
		C _I	input capacitance	V _{CC} = 3.3 V; V _I = GND to V _{CC}	-	2.5	-	-	-	pF

[1] All typical values are measured at V_{CC} = 3.3 V and T_{amb} = 25 °C.

10.1. Transfer characteristics

Table 24. Transfer characteristics

Voltages are referenced to GND (ground = 0 V; for test circuit see [Fig. 27](#))

Symbol	Parameter	Conditions	-40 °C to +85 °C			-40 °C to +125 °C		Unit
			Min	Typ [1]	Max	Min	Max	
V _{T+}	positive-going threshold voltage	see Fig. 20 , Fig. 21 , Fig. 22 , Fig. 23 and Fig. 24						
		V _{CC} = 1.8 V	0.70	1.02	1.20	0.67	1.20	V
		V _{CC} = 2.3 V	1.11	1.42	1.60	1.08	1.60	V
		V _{CC} = 3.0 V	1.50	1.79	2.00	1.47	2.00	V
		V _{CC} = 4.5 V	2.16	2.52	2.74	2.13	2.74	V
		V _{CC} = 5.5 V	2.61	2.99	3.33	2.58	3.33	V
V _{T-}	negative-going threshold voltage	see Fig. 20 , Fig. 21 , Fig. 22 , Fig. 23 and Fig. 24						
		V _{CC} = 1.8 V	0.30	0.53	0.72	0.30	0.75	V
		V _{CC} = 2.3 V	0.58	0.77	1.00	0.58	1.03	V
		V _{CC} = 3.0 V	0.80	1.04	1.30	0.80	1.33	V
		V _{CC} = 4.5 V	1.21	1.55	1.90	1.21	1.93	V
		V _{CC} = 5.5 V	1.45	1.86	2.29	1.45	2.32	V
V _H	hysteresis voltage	(V _{T+} - V _{T-}); see Fig. 20 , Fig. 21 , Fig. 22 , Fig. 23 and Fig. 24						
		V _{CC} = 1.8 V	0.30	0.48	0.62	0.23	0.62	V
		V _{CC} = 2.3 V	0.40	0.64	0.80	0.34	0.80	V
		V _{CC} = 3.0 V	0.50	0.75	1.00	0.44	1.00	V
		V _{CC} = 4.5 V	0.71	0.97	1.20	0.65	1.20	V
		V _{CC} = 5.5 V	0.71	1.13	1.40	0.65	1.40	V

[1] All typical values are measured at T_{amb} = 25 °C

10.2. Waveforms transfer characteristics

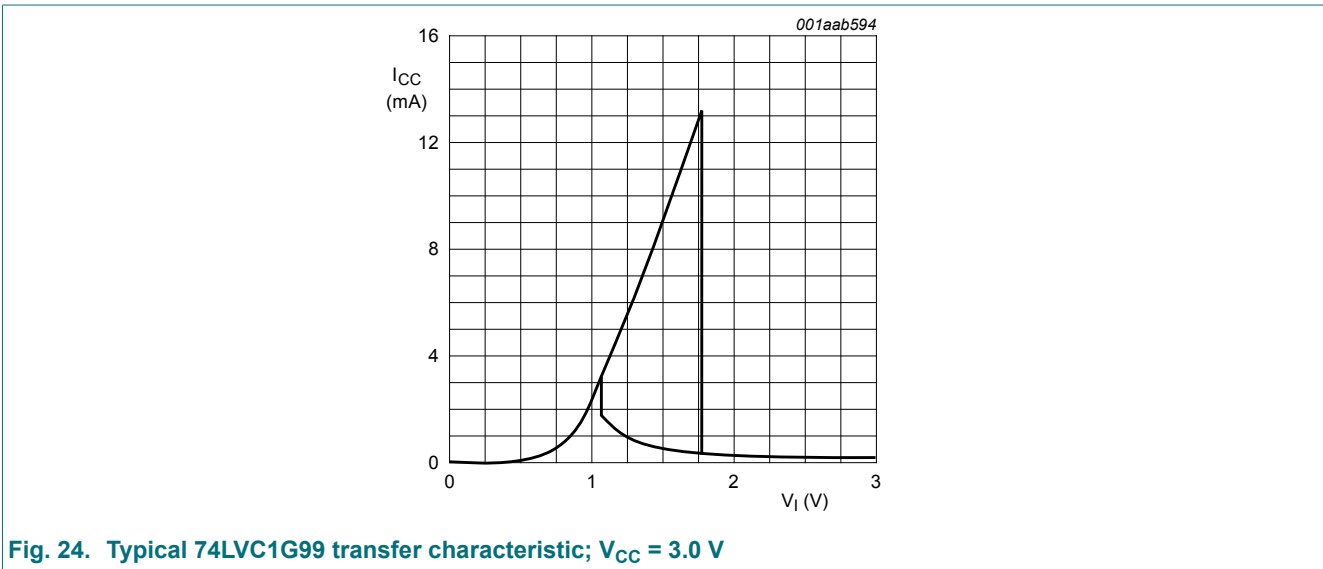
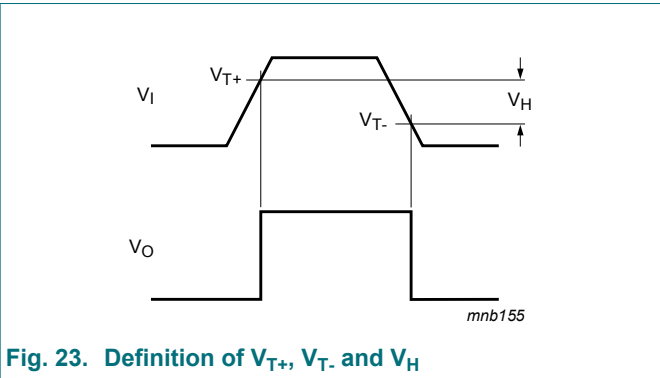
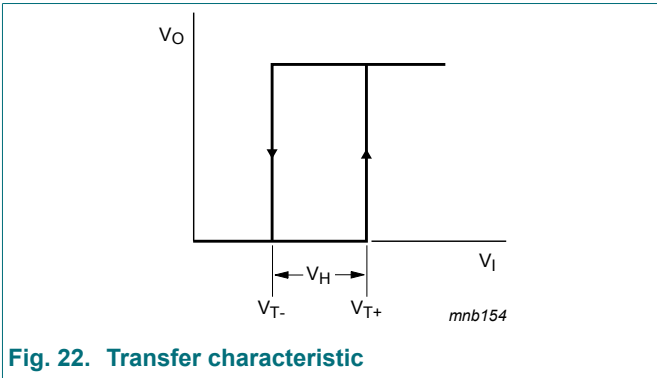
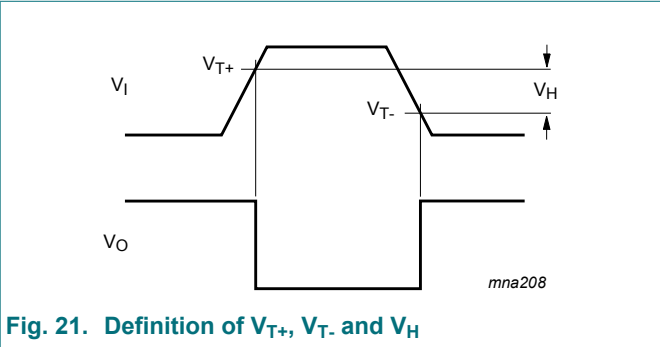
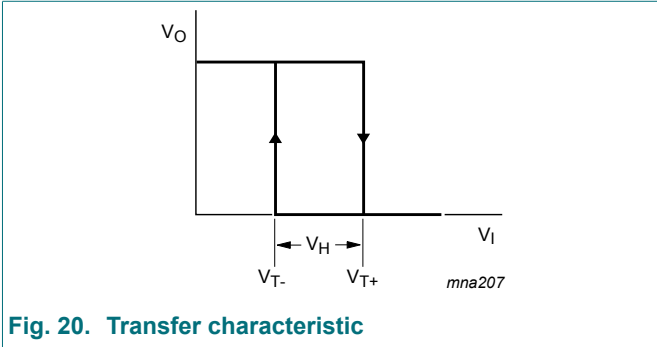

11. Dynamic characteristics

Table 25. Dynamic characteristics

Voltages are referenced to GND (ground = 0 V; for test circuit see Fig. 27).

Symbol	Parameter	Conditions	T _{amb} = -40 °C to +85 °C			T _{amb} = -40 °C to +125 °C		Unit
			Min	Typ [1]	Max	Min	Max	
t _{pd}	propagation delay	A to Y; see Fig. 25 [2]						
		V _{CC} = 1.65 V to 1.95 V	2.8	7.5	30.8	2.8	38.5	ns
		V _{CC} = 2.3 V to 2.7 V	2.0	5.0	11.7	2.0	14.6	ns
		V _{CC} = 2.7 V	2.0	5.4	9.0	2.0	11.3	ns
		V _{CC} = 3.0 V to 3.6 V	1.8	4.5	8.4	1.8	10.5	ns
		V _{CC} = 4.5 V to 5.5 V	1.8	3.8	5.5	1.8	6.9	ns
		B to Y; see Fig. 25 [2]						
		V _{CC} = 1.65 V to 1.95 V	2.8	7.5	28.9	2.8	36.2	ns
		V _{CC} = 2.3 V to 2.7 V	2.0	5.0	11.3	2.0	14.2	ns
		V _{CC} = 2.7 V	2.0	5.4	9.0	2.0	11.3	ns
		V _{CC} = 3.0 V to 3.6 V	1.8	4.5	8.2	1.8	10.3	ns
		V _{CC} = 4.5 V to 5.5 V	1.8	3.8	5.4	1.8	6.8	ns
		C to Y; see Fig. 25 [2]						
		V _{CC} = 1.65 V to 1.95 V	3.2	7.8	29.8	3.2	37.3	ns
		V _{CC} = 2.3 V to 2.7 V	2.3	5.2	12.3	2.3	15.4	ns
		V _{CC} = 2.7 V	2.3	5.3	9.6	2.3	12.0	ns
		V _{CC} = 3.0 V to 3.6 V	2.3	4.6	8.6	2.3	10.8	ns
		V _{CC} = 4.5 V to 5.5 V	1.8	3.8	5.7	1.8	7.2	ns
		D to Y; see Fig. 25 [2]						
		V _{CC} = 1.65 V to 1.95 V	2.8	7.0	25.7	2.8	32.2	ns
		V _{CC} = 2.3 V to 2.7 V	2.0	4.6	10.7	2.0	13.4	ns
		V _{CC} = 2.7 V	2.0	4.8	9.2	2.0	11.5	ns
		V _{CC} = 3.0 V to 3.6 V	1.8	4.1	7.6	1.8	9.5	ns
		V _{CC} = 4.5 V to 5.5 V	1.6	3.4	5.2	1.6	6.5	ns

Ultra-configurable multiple function gate; 3-state

Symbol	Parameter	Conditions	T _{amb} = -40 °C to +85 °C			T _{amb} = -40 °C to +125 °C		Unit
			Min	Typ [1]	Max	Min	Max	
t _{en}	enable time	OE to Y; see Fig. 26 [3]						
		V _{CC} = 1.65 V to 1.95 V	2.0	5.7	25.2	2.0	32.0	ns
		V _{CC} = 2.3 V to 2.7 V	1.4	3.8	11.3	1.4	14.0	ns
		V _{CC} = 2.7 V	1.4	4.2	8.6	1.4	11.0	ns
		V _{CC} = 3.0 V to 3.6 V	1.4	3.5	7.0	1.4	9.0	ns
		V _{CC} = 4.5 V to 5.5 V	1.4	2.7	4.7	1.4	6.0	ns
t _{dis}	disable time	OE to Y; see Fig. 26 [4]						
		V _{CC} = 1.65 V to 1.95 V	3.0	5.7	15.0	3.0	19.0	ns
		V _{CC} = 2.3 V to 2.7 V	2.0	3.6	5.8	2.0	7.3	ns
		V _{CC} = 2.7 V	2.0	4.5	6.6	2.0	8.2	ns
		V _{CC} = 3.0 V to 3.6 V	2.1	4.5	5.9	2.1	7.4	ns
		V _{CC} = 4.5 V to 5.5 V	1.0	3.4	4.5	1.0	5.6	ns
C _{PD}	power dissipation capacitance	per buffer (output enabled); f _i = 10 MHz; C _L = 50 pF; V _I = GND to V _{CC} [5]						
		V _{CC} = 1.65 V to 1.95 V	-	14	-	-	-	pF
		V _{CC} = 2.3 V to 2.7 V	-	16	-	-	-	pF
		V _{CC} = 2.7 V	-	18	-	-	-	pF
		V _{CC} = 3.0 V to 3.6 V	-	25	-	-	-	pF
		V _{CC} = 4.5 V to 5.5 V	-	30	-	-	-	pF

- [1] All typical values are measured at nominal V_{CC} and T_{amb} = 25 °C.
- [2] t_{pd} is the same as t_{PLH} and t_{PHL}.
- [3] t_{en} is the same as t_{PZH} and t_{PZL}.
- [4] t_{dis} is the same as t_{PHZ} and t_{PLZ}.
- [5] C_{PD} is used to determine the dynamic power dissipation (P_D in μW).
 $P_D = C_{PD} \times V_{CC}^2 \times f_i \times N + \Sigma(C_L \times V_{CC}^2 \times f_o)$ where:
 f_i = input frequency in MHz;
 f_o = output frequency in MHz;
 C_L = output load capacitance in pF;
 V_{CC} = supply voltage in V;
 N = number of inputs switching;
 Σ(C_L × V_{CC}² × f_o) = sum of the outputs.

11.1. Waveforms and test circuit

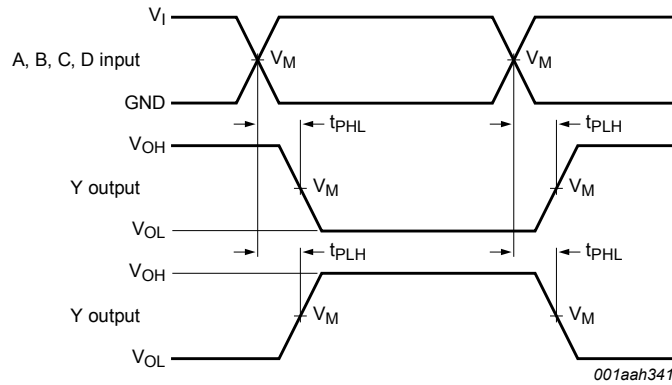

Measurement points are given in Table 26.

Logic levels: V_{OL} and V_{OH} are typical output voltage levels that occur with the output load.

Fig. 25. The data input (A, B, C, D) to output (Y) propagation delays

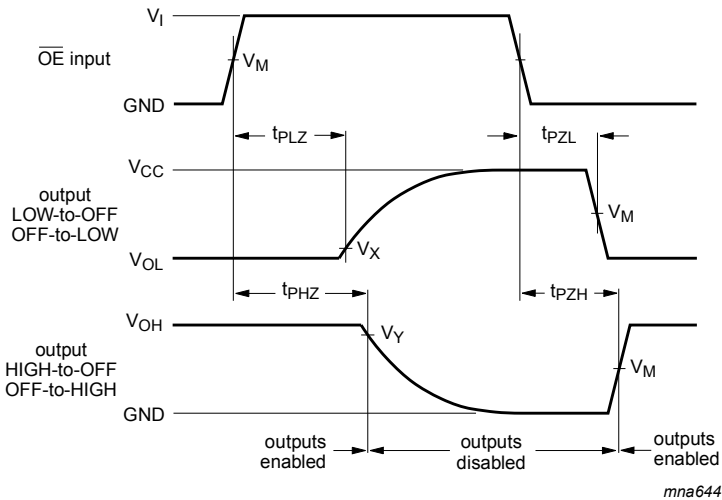

Measurement points are given in Table 26.

Logic levels: V_{OL} and V_{OH} are typical output voltage levels that occur with the output load.

Fig. 26. 3-state enable and disable times

Table 26. Measurement points

Supply voltage	Input	Output		
V_{CC}	V_M	V_M	V_X	V_Y
1.65 V to 1.95 V	$0.5V_{CC}$	$0.5V_{CC}$	$V_{OL} + 0.15 V$	$V_{OH} - 0.15 V$
2.3 V to 2.7 V	$0.5V_{CC}$	$0.5V_{CC}$	$V_{OL} + 0.15 V$	$V_{OH} - 0.15 V$
2.7 V	1.5 V	1.5 V	$V_{OL} + 0.3 V$	$V_{OH} - 0.3 V$
3.0 V to 3.6 V	1.5 V	1.5 V	$V_{OL} + 0.3 V$	$V_{OH} - 0.3 V$
4.5 V to 5.5 V	$0.5V_{CC}$	$0.5V_{CC}$	$V_{OL} + 0.3 V$	$V_{OH} - 0.3 V$

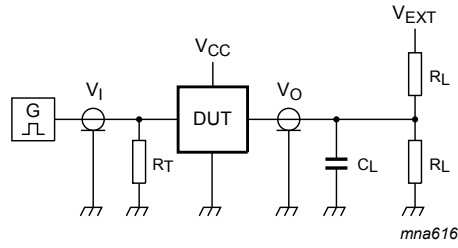

Test data is given in [Table 27](#).

Definitions for test circuit:

R_L = Load resistance.

C_L = Load capacitance including jig and probe capacitance.

R_T = Termination resistance should be equal to the output impedance Z_o of the pulse generator.

V_{EXT} = External voltage for measuring switching times.

Fig. 27. Test circuit for measuring switching times

Table 27. Test data

Supply voltage	Input		Load		V_{EXT}		
	V_I	$t_r = t_f$	C_L	R_L	t_{PLH}, t_{PHL}	t_{PZH}, t_{PHZ}	t_{PZL}, t_{PLZ}
1.65 V to 1.95 V	V_{CC}	≤ 2.0 ns	30 pF	1 k Ω	open	GND	$2V_{CC}$
2.3 V to 2.7 V	V_{CC}	≤ 2.0 ns	30 pF	500 Ω	open	GND	$2V_{CC}$
2.7 V	2.7 V	≤ 2.5 ns	50 pF	500 Ω	open	GND	6 V
3.0 V to 3.6 V	2.7 V	≤ 2.5 ns	50 pF	500 Ω	open	GND	6 V
4.5 V to 5.5 V	V_{CC}	≤ 2.5 ns	50 pF	500 Ω	open	GND	$2V_{CC}$

12. Package outline

TSSOP8: plastic thin shrink small outline package; 8 leads; body width 3 mm; lead length 0.5 mm SOT505-2

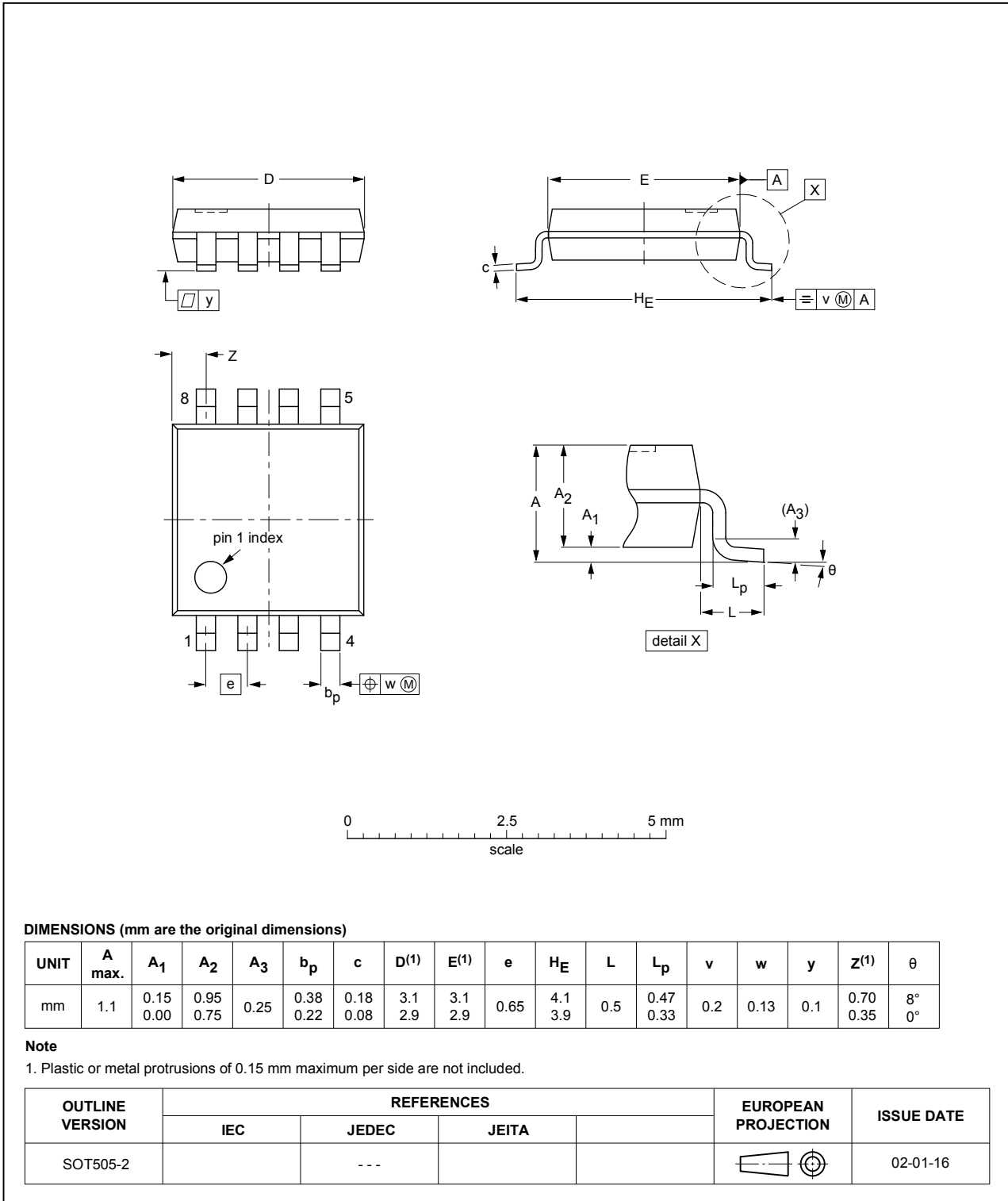

Fig. 28. Package outline SOT505-2 (TSSOP8)

XSON8: plastic extremely thin small outline package; no leads; 8 terminals; body 1 x 1.95 x 0.5 mm

SOT833-1

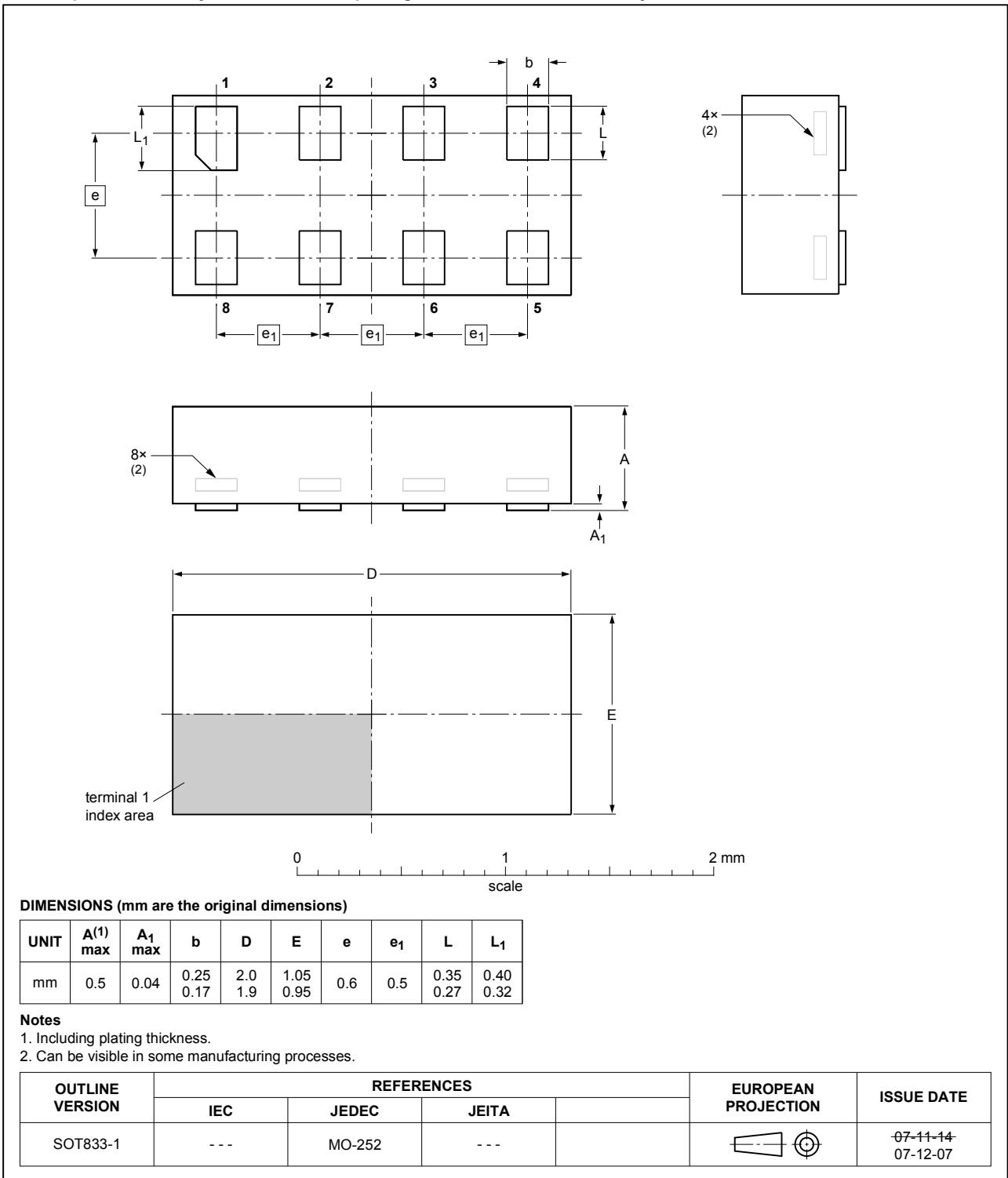

Fig. 29. Package outline SOT833-1 (XSON8)

XSON8: extremely thin small outline package; no leads;
8 terminals; body 1.35 x 1 x 0.5 mm

SOT1089

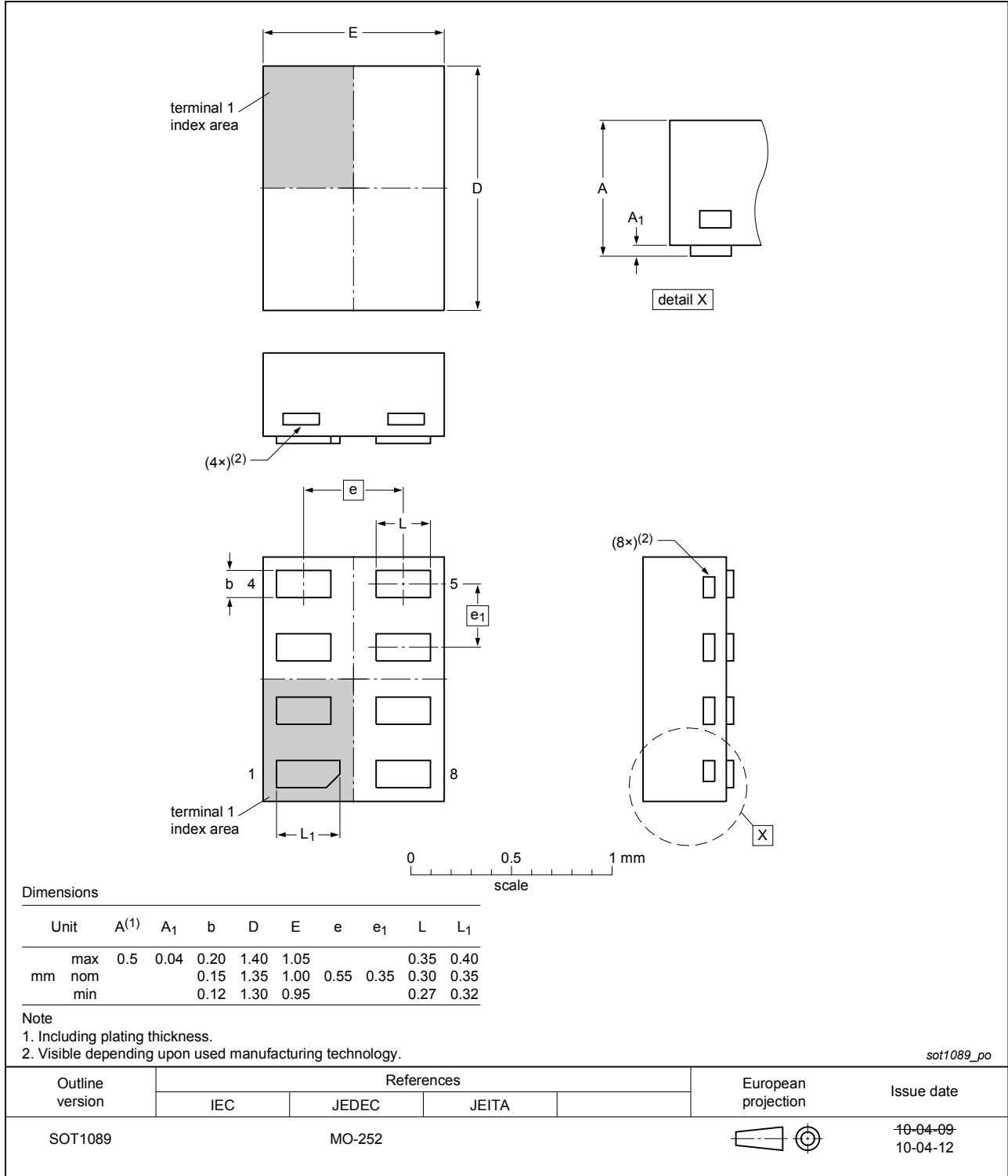

Fig. 30. Package outline SOT1089 (XSON8)

XQFN8: plastic, extremely thin quad flat package; no leads;
8 terminals; body 1.6 x 1.6 x 0.5 mm

SOT902-2



Fig. 31. Package outline SOT902-2 (XQFN8)

XSON8: extremely thin small outline package; no leads;
8 terminals; body 1.2 x 1.0 x 0.35 mm

SOT1116

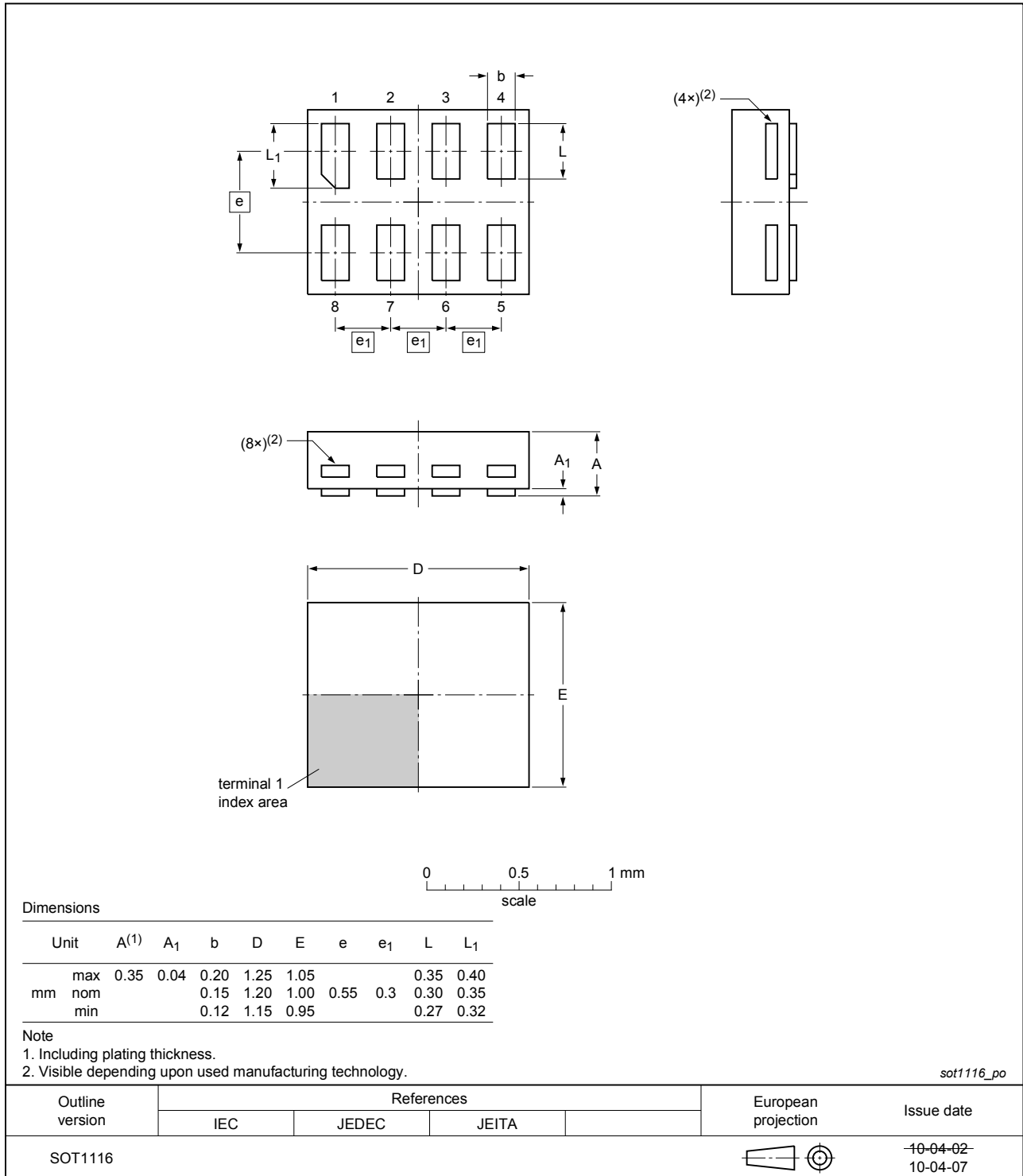

Fig. 32. Package outline SOT1116 (XSON8)

XSON8: extremely thin small outline package; no leads;
8 terminals; body 1.35 x 1.0 x 0.35 mm

SOT1203



Fig. 33. Package outline SOT1203 (XSON8)

13. Abbreviations

Table 28. Abbreviations

Acronym	Description
CMOS	Complementary Metal-Oxide Semiconductor
DUT	Device Under Test
ESD	ElectroStatic Discharge
HBM	Human Body Model
MM	Machine Model
TTL	Transistor-Transistor Logic

14. Revision history

Table 29. Revision history

Document ID	Release date	Data sheet status	Change notice	Supersedes
74LVC1G99 v.10.1	20181022	Product data sheet	-	74LVC1G99 v.10
Modifications:	<ul style="list-style-type: none"> • Table 12: input D logic level changed to HIGH. 			
74LVC1G99 v.10	20180927	Product data sheet	-	74LVC1G99 v.9
Modifications:	<ul style="list-style-type: none"> • The format of this data sheet has been redesigned to comply with the identity guidelines of Nexperia. • Legal texts have been adapted to the new company name where appropriate. • Type number 74LVC1G99GD (SOT996-2) removed. 			
74LVC1G99 v.9	20161212	Product data sheet	-	74LVC1G99 v.8
Modifications:	<ul style="list-style-type: none"> • Table 23: The maximum limits for leakage current and supply current have changed. 			
74LVC1G99 v.8	20130405	Product data sheet	-	74LVC1G99 v.7
Modifications:	<ul style="list-style-type: none"> • For type number 74LVC1G99GD XSON8U has changed to XSON8. 			
74LVC1G99 v.7	20120622	Product data sheet	-	74LVC1G99 v.6
Modifications:	<ul style="list-style-type: none"> • For type number 74LVC1G99GM the SOT code has changed to SOT902-2. 			
74LVC1G99 v.6	20111201	Product data sheet	-	74LVC1G99 v.5
Modifications:	<ul style="list-style-type: none"> • Legal pages updated. 			
74LVC1G99 v.5	20101021	Product data sheet	-	74LVC1G99 v.4
74LVC1G99 v.4	20100416	Product data sheet	-	74LVC1G99 v.3
74LVC1G99 v.3	20091203	Product data sheet	-	74LVC1G99 v.2
74LVC1G99 v.2	20080208	Product data sheet	-	74LVC1G99 v.1
74LVC1G99 v.1	20080103	Product data sheet	-	-

15. Legal information

Data sheet status

Document status [1][2]	Product status [3]	Definition
Objective [short] data sheet	Development	This document contains data from the objective specification for product development.
Preliminary [short] data sheet	Qualification	This document contains data from the preliminary specification.
Product [short] data sheet	Production	This document contains the product specification.

- [1] Please consult the most recently issued document before initiating or completing a design.
- [2] The term 'short data sheet' is explained in section "Definitions".
- [3] The product status of device(s) described in this document may have changed since this document was published and may differ in case of multiple devices. The latest product status information is available on the internet at <https://www.nexperia.com>.

Definitions

Draft — The document is a draft version only. The content is still under internal review and subject to formal approval, which may result in modifications or additions. Nexperia does not give any representations or warranties as to the accuracy or completeness of information included herein and shall have no liability for the consequences of use of such information.

Short data sheet — A short data sheet is an extract from a full data sheet with the same product type number(s) and title. A short data sheet is intended for quick reference only and should not be relied upon to contain detailed and full information. For detailed and full information see the relevant full data sheet, which is available on request via the local Nexperia sales office. In case of any inconsistency or conflict with the short data sheet, the full data sheet shall prevail.

Product specification — The information and data provided in a Product data sheet shall define the specification of the product as agreed between Nexperia and its customer, unless Nexperia and customer have explicitly agreed otherwise in writing. In no event however, shall an agreement be valid in which the Nexperia product is deemed to offer functions and qualities beyond those described in the Product data sheet.

Disclaimers

Limited warranty and liability — Information in this document is believed to be accurate and reliable. However, Nexperia does not give any representations or warranties, expressed or implied, as to the accuracy or completeness of such information and shall have no liability for the consequences of use of such information. Nexperia takes no responsibility for the content in this document if provided by an information source outside of Nexperia.

In no event shall Nexperia be liable for any indirect, incidental, punitive, special or consequential damages (including - without limitation - lost profits, lost savings, business interruption, costs related to the removal or replacement of any products or rework charges) whether or not such damages are based on tort (including negligence), warranty, breach of contract or any other legal theory.

Notwithstanding any damages that customer might incur for any reason whatsoever, Nexperia's aggregate and cumulative liability towards customer for the products described herein shall be limited in accordance with the Terms and conditions of commercial sale of Nexperia.

Right to make changes — Nexperia reserves the right to make changes to information published in this document, including without limitation specifications and product descriptions, at any time and without notice. This document supersedes and replaces all information supplied prior to the publication hereof.

Suitability for use — Nexperia products are not designed, authorized or warranted to be suitable for use in life support, life-critical or safety-critical systems or equipment, nor in applications where failure or malfunction of an Nexperia product can reasonably be expected to result in personal

injury, death or severe property or environmental damage. Nexperia and its suppliers accept no liability for inclusion and/or use of Nexperia products in such equipment or applications and therefore such inclusion and/or use is at the customer's own risk.

Quick reference data — The Quick reference data is an extract of the product data given in the Limiting values and Characteristics sections of this document, and as such is not complete, exhaustive or legally binding.

Applications — Applications that are described herein for any of these products are for illustrative purposes only. Nexperia makes no representation or warranty that such applications will be suitable for the specified use without further testing or modification.

Customers are responsible for the design and operation of their applications and products using Nexperia products, and Nexperia accepts no liability for any assistance with applications or customer product design. It is customer's sole responsibility to determine whether the Nexperia product is suitable and fit for the customer's applications and products planned, as well as for the planned application and use of customer's third party customer(s). Customers should provide appropriate design and operating safeguards to minimize the risks associated with their applications and products.

Nexperia does not accept any liability related to any default, damage, costs or problem which is based on any weakness or default in the customer's applications or products, or the application or use by customer's third party customer(s). Customer is responsible for doing all necessary testing for the customer's applications and products using Nexperia products in order to avoid a default of the applications and the products or of the application or use by customer's third party customer(s). Nexperia does not accept any liability in this respect.

Limiting values — Stress above one or more limiting values (as defined in the Absolute Maximum Ratings System of IEC 60134) will cause permanent damage to the device. Limiting values are stress ratings only and (proper) operation of the device at these or any other conditions above those given in the Recommended operating conditions section (if present) or the Characteristics sections of this document is not warranted. Constant or repeated exposure to limiting values will permanently and irreversibly affect the quality and reliability of the device.

Terms and conditions of commercial sale — Nexperia products are sold subject to the general terms and conditions of commercial sale, as published at <http://www.nexperia.com/profile/terms>, unless otherwise agreed in a valid written individual agreement. In case an individual agreement is concluded only the terms and conditions of the respective agreement shall apply. Nexperia hereby expressly objects to applying the customer's general terms and conditions with regard to the purchase of Nexperia products by customer.

No offer to sell or license — Nothing in this document may be interpreted or construed as an offer to sell products that is open for acceptance or the grant, conveyance or implication of any license under any copyrights, patents or other industrial or intellectual property rights.

Export control — This document as well as the item(s) described herein may be subject to export control regulations. Export might require a prior authorization from competent authorities.

Non-automotive qualified products — Unless this data sheet expressly states that this specific Nexperia product is automotive qualified, the product is not suitable for automotive use. It is neither qualified nor tested in accordance with automotive testing or application requirements. Nexperia accepts no liability for inclusion and/or use of non-automotive qualified products in automotive equipment or applications.

In the event that customer uses the product for design-in and use in automotive applications to automotive specifications and standards, customer (a) shall use the product without Nexperia's warranty of the product for such automotive applications, use and specifications, and (b) whenever customer uses the product for automotive applications beyond Nexperia's specifications such use shall be solely at customer's own risk, and (c) customer fully indemnifies Nexperia for any liability, damages or failed product claims resulting from customer design and use of the product for automotive applications beyond Nexperia's standard warranty and Nexperia's product specifications.

Translations — A non-English (translated) version of a document is for reference only. The English version shall prevail in case of any discrepancy between the translated and English versions.

Trademarks

Notice: All referenced brands, product names, service names and trademarks are the property of their respective owners.

Contents

1. General description	1
2. Features and benefits	1
3. Ordering information	2
4. Marking	2
5. Functional diagram	2
6. Pinning information	3
6.1. Pinning.....	3
6.2. Pin description.....	3
7. Functional description	4
7.1. Logic configurations.....	4
7.2. 3-state buffer functions available.....	5
7.3. 3-state inverter functions available.....	5
7.4. 3-state multiplexer functions available.....	6
7.5. 3-state AND/NOR functions available.....	6
7.6. 3-state NAND/OR functions available.....	7
7.7. 3-state XOR/XNOR functions available.....	9
8. Limiting values	10
9. Recommended operating conditions	10
10. Static characteristics	11
10.1. Transfer characteristics.....	12
10.2. Waveforms transfer characteristics.....	13
11. Dynamic characteristics	14
11.1. Waveforms and test circuit.....	16
12. Package outline	18
13. Abbreviations	24
14. Revision history	24
15. Legal information	25

© Nexperia B.V. 2018. All rights reserved

For more information, please visit: <http://www.nexperia.com>
 For sales office addresses, please send an email to: salesaddresses@nexperia.com
 Date of release: 22 October 2018
