

DESCRIPTION: 0.085 RIBBON - SOLDER CUP

	014	024	036	050
A	1.728	2.154	2.667	3.264
	43.90	54.70	67.75	82.90
B	0.992	1.417	1.925	2.624
	25.20	36.00	48.90	64.10
C	1.417	1.843	2.352	2.947
	36.00	46.80	59.74	74.85

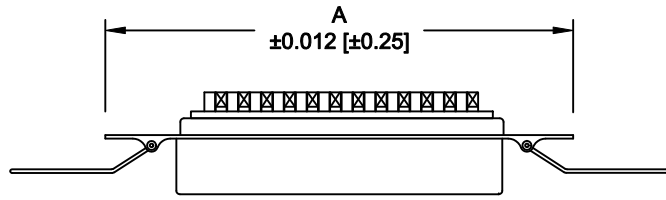

**MATERIAL:**

INSULATION: PBT - UL 94V-0 RATED  
 CONTACTS: PHOSPHOR BRONZE  
 CONTACT PLATING: GOLD FLASH IN THE MATING AREA  
 BRIGHT TIN IN THE SOLDER AREA  
 SHELL: STEEL, NICKEL PLATED

**ELECTRICAL:**

CURRENT RATING: 1 AMPS  
 VOLTAGE RATING: 1,000V AC r.m.s.  
 INSULATION RESISTANCE: 1,000MegOhms Min. @ 500VDC  
 CONTACT RESISTANCE: 30MilliOhms Max.  
 OPERATING TEMPERATURE: -55°C TO +125°C

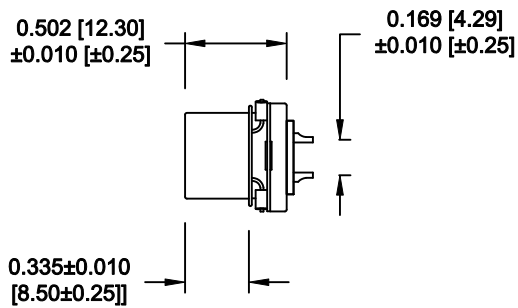
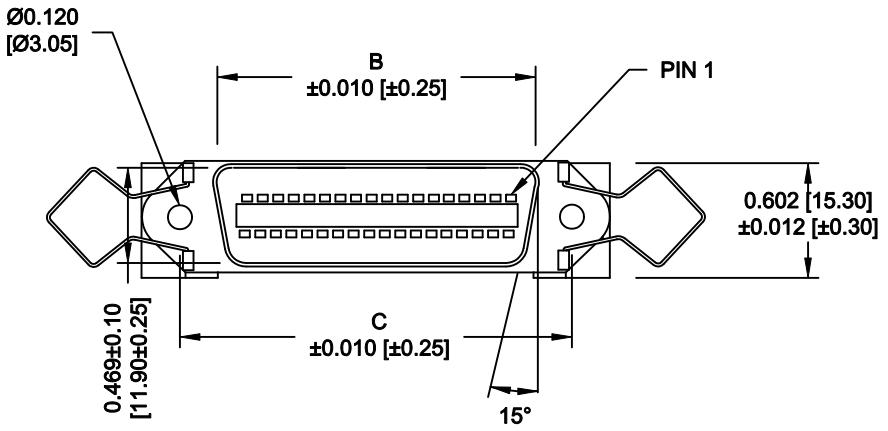

111-YYY-2 0 3 L 00 1

SERIES \_\_\_\_\_  
 POSITIONS \_\_\_\_\_  
 014 \_\_\_\_\_  
 024 \_\_\_\_\_  
 036 \_\_\_\_\_  
 050 \_\_\_\_\_  
 GENDER \_\_\_\_\_  
 2 = FEMALE \_\_\_\_\_  
 TERMINATION \_\_\_\_\_  
 0 = SOLDER CUP \_\_\_\_\_  
 SHELL PLATING \_\_\_\_\_  
 3 = NICKEL \_\_\_\_\_  
 RoHS COMPLIANT \_\_\_\_\_  
 L = LOW TEMP. PROCESS \_\_\_\_\_  
 HARDWARE \_\_\_\_\_  
 00 = NO HARDWARE \_\_\_\_\_  
 PLATING \_\_\_\_\_  
 1 = GOLD FLASH \_\_\_\_\_

WILL ACCEPT 26-20 AWG WIRE

DO NOT SCALE FROM DRAWING

	THESE DRAWINGS AND SPECIFICATIONS ARE THE PROPERTY OF NorComp AND SHALL NOT BE REPRODUCED, COPIED OR USED AS THE BASIS FOR THE MANUFACTURE OF SALE OF APPARATUS WITHOUT WRITTEN PERMISSION.		DRAWN: <b>WAYNE ROBBINS</b>	DATE: <b>09-15-05</b>
			CHECKED:	DATE:
<h1>NorComp</h1>		SCALE: <b>NONE</b>	SHEET <b>1</b> OF <b>2</b>	REV <b>9</b>
		DWG NO. <b>111-YYY-203L001</b>		

RoHS COMPLIANT

	014	024	036	050
C	1.417	1.843	2.352	2.947
	36.00	46.80	59.74	74.85

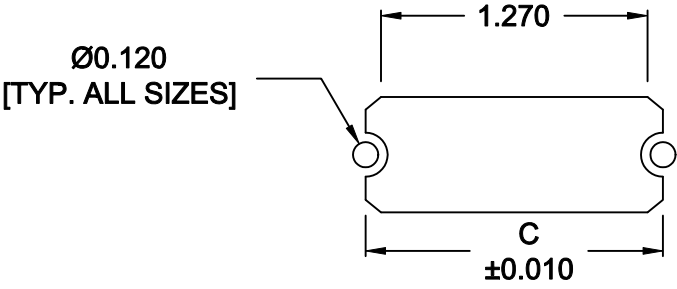

14 POSITION

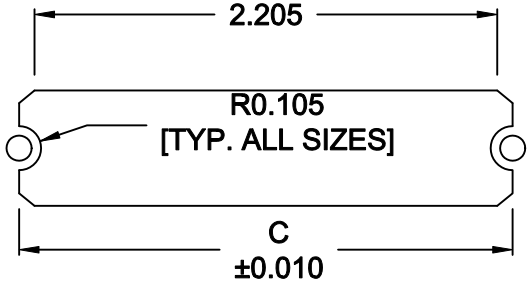

36 POSITION

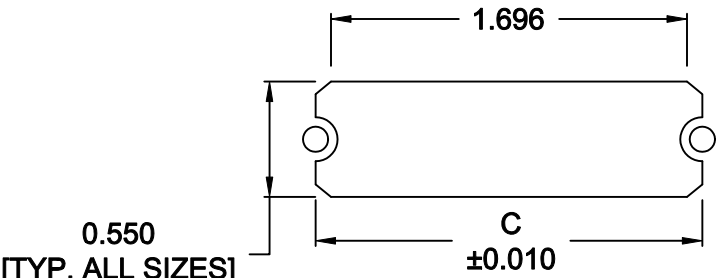

24 POSITION

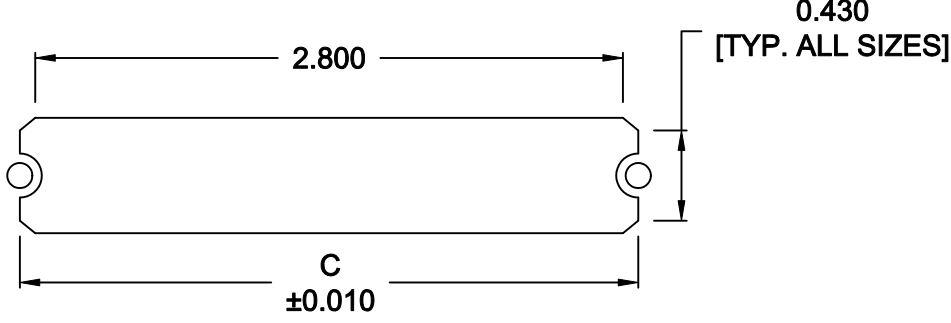



50 POSITION

\*\*\*NOTE\*\*\* DIMENSION "C" =  
 CENTER TO CENTER OF MOUNTING HOLES  
 CENTER OF RADI  
 OVERALL LENGTH OF CUTOUT

RoHS COMPLIANT

DO NOT SCALE FROM DRAWING

	THESE DRAWINGS AND SPECIFICATIONS ARE THE PROPERTY OF NorComp AND SHALL NOT BE REPRODUCED, COPIED OR USED AS THE BASIS FOR THE MANUFACTURE OF SALE OF APPARATUS WITHOUT WRITTEN PERMISSION.	DRAWN: <b>M. SIGMON</b>	DATE: <b>01-14-11</b>	
		CHECKED:	DATE:	
		SCALE: <b>NONE</b>	SHEET <b>2</b> OF <b>2</b>	REV <b>9</b>
		DWG NO. <b>111-YYY-203L001</b>		

# Mouser Electronics

Authorized Distributor

Click to View Pricing, Inventory, Delivery & Lifecycle Information:

[NorComp:](#)

[111-014-203L001](#) [111-024-203L001](#) [111-036-203L001](#) [111-050-203L001](#)