

THIS DOCUMENT IS THE PROPERTY OF
KEYSTONE ELECTRONICS CORP. AND
SHALL NOT BE REPRODUCED, DISTRIBUTED
OR USED AS A BASIS FOR MANUFACTURE
WITHOUT PRIOR WRITTEN PERMISSION
FROM KEYSTONE ELECTRONICS CORP.

ACTUAL SIZE
P/N 9022

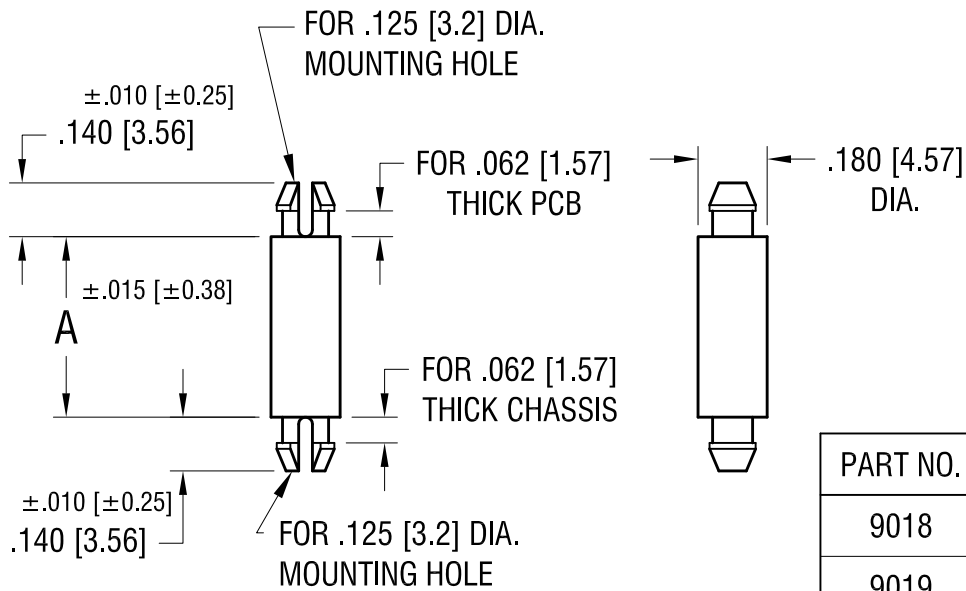
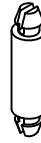

PART NO.	'A' DIM.
9018	.125 [3.18]
9019	.187 [4.75]
9020	.250 [6.35]
9021	.375 [9.52]
9022	.500 [12.70]
9023	.625 [15.87]
9024	.750 [19.05]
9025	.875 [22.22]
9026	1.000 [25.40]

KEYSTONE ELECTRONICS CORP.

www.keyelco.com • ASTORIA, N.Y. 11105-2017 • Tel (718) 956-8900

PART NAME		PC LOCK-IN SUPPORT	
MATERIAL		NYLON UL 94V-0	
FINISH	-	DRN BY	BOONE
		APP'D	LN
		DATE	8.29.06
		SCALE	2X
TOLERANCES	INCH [MM]	CODE	DWG NO.
DECIMAL	± .005 [± 0.13]	C	9018-9026
ANGULAR	± 1°		
UNLESS OTHERWISE SPECIFIED			

3.25.15	CHANGE AS PER ECN 15-038	A
DATE	DESCRIPTION	REV.

Mouser Electronics

Authorized Distributor

Click to View Pricing, Inventory, Delivery & Lifecycle Information:

[Keystone Electronics:](#)

[9025](#)