

DirectFET® N-Channel Power MOSFET

Application

- Brushed motor drive applications
- BLDC motor drive applications
- Battery powered circuits
- Half-bridge and full-bridge topologies
- Synchronous rectifier applications
- Resonant mode power supplies
- OR-ing and redundant power switches
- DC/DC and AC/DC converters
- DC/AC inverters

Benefits

- Improved gate, avalanche and dynamic dv/dt ruggedness
- Fully characterized capacitance and avalanche SOA
- Enhanced body diode dv/dt and di/dt capability
- Lead-free, RoHS compliant

V_{DSS}	60V
R_{DS(on)} typ.	2.9mΩ
	3.6mΩ
max	
I_D	114A

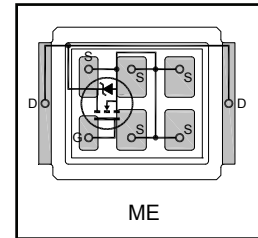

Base part number	Package Type	Standard Pack		Orderable Part Number
		Form	Quantity	
IRF7580MPbF	DirectFET® ME	Tape and Reel	4800	IRF7580MTRPbF

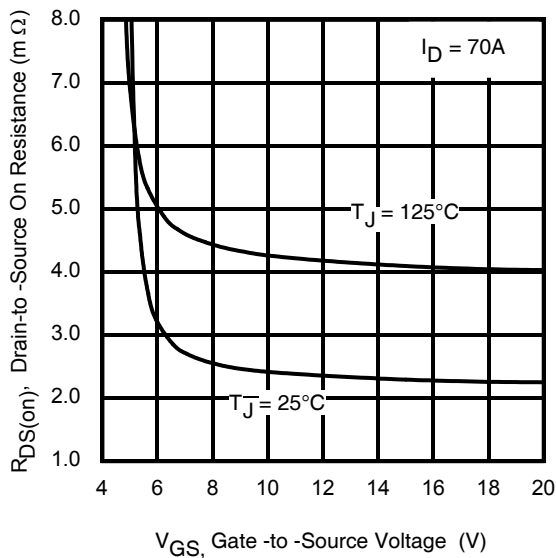

Fig 1. Typical On-Resistance vs. Gate Voltage

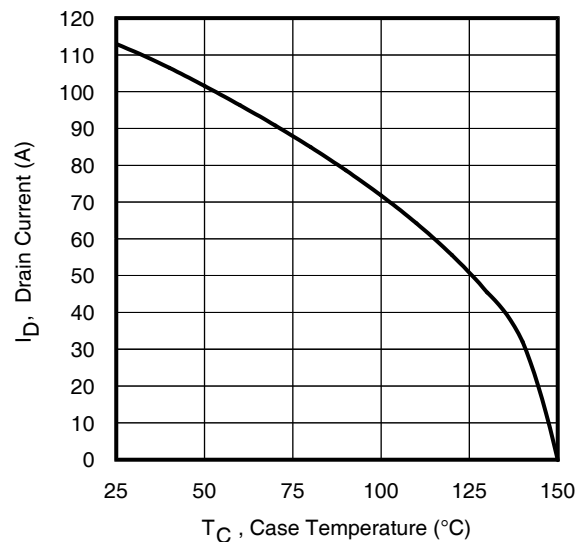

Fig 2. Maximum Drain Current vs. Case Temperature

Absolute Maximum Ratings

Symbol	Parameter	Max.	Units
$I_D @ T_C = 25^\circ\text{C}$	Continuous Drain Current, $V_{GS} @ 10\text{V}$	114	A
$I_D @ T_C = 100^\circ\text{C}$	Continuous Drain Current, $V_{GS} @ 10\text{V}$	72	
I_{DM}	Pulsed Drain Current ①	452	
$P_D @ T_C = 25^\circ\text{C}$	Maximum Power Dissipation	96	W
	Linear Derating Factor	0.78	W/°C
V_{GS}	Gate-to-Source Voltage	± 20	V
T_J T_{STG}	Operating Junction and Storage Temperature Range	-55 to + 150	°C

Avalanche Characteristics

E_{AS} (Thermally limited)	Single Pulse Avalanche Energy ②	81	mJ
E_{AS} (Thermally limited)	Single Pulse Avalanche Energy ③	149	
I_{AR}	Avalanche Current ①	See Fig.15,16 , 23a, 23b	A
E_{AR}	Repetitive Avalanche Energy ①		mJ

Thermal Resistance

Symbol	Parameter	Typ.	Max.	Units
$R_{\theta JA}$	Junction-to-Ambient ① ⑦	—	44	°C/W
$R_{\theta JA}$	Junction-to-Ambient ③	12.5	—	
$R_{\theta JA}$	Junction-to-Ambient ②	20	—	
$R_{\theta JC}$	Junction-to-Case ④ ⑧	—	1.3	
$R_{\theta J-PCB}$	Junction-to-PCB Mounted ②	0.75	—	

Static @ $T_J = 25^\circ\text{C}$ (unless otherwise specified)

Symbol	Parameter	Min.	Typ.	Max.	Units	Conditions
$V_{(BR)DSS}$	Drain-to-Source Breakdown Voltage	60	—	—	V	$V_{GS} = 0\text{V}, I_D = 250\mu\text{A}$
$\Delta V_{(BR)DSS}/\Delta T_J$	Breakdown Voltage Temp. Coefficient	—	44	—	mV/°C	Reference to $25^\circ\text{C}, I_D = 1.0\text{mA}$
$R_{DS(on)}$	Static Drain-to-Source On-Resistance	—	2.9	3.6	mΩ	$V_{GS} = 10\text{V}, I_D = 70\text{A}$ ④
		—	3.5	—	mΩ	$V_{GS} = 6.0\text{V}, I_D = 35\text{A}$ ④
$V_{GS(th)}$	Gate Threshold Voltage	2.1	—	3.7	V	$V_{DS} = V_{GS}, I_D = 150\mu\text{A}$
I_{DSS}	Drain-to-Source Leakage Current	—	—	1.0	μA	$V_{DS} = 60\text{V}, V_{GS} = 0\text{V}$
		—	—	150	μA	$V_{DS} = 60\text{V}, V_{GS} = 0\text{V}, T_J = 125^\circ\text{C}$
I_{GSS}	Gate-to-Source Forward Leakage	—	—	100	nA	$V_{GS} = 20\text{V}$
	Gate-to-Source Reverse Leakage	—	—	-100	nA	$V_{GS} = -20\text{V}$
R_G	Internal Gate Resistance	—	0.8	—	Ω	

Notes:

- ② Mounted on minimum footprint full size board with metalized back and with small clip heatsink.
- ③ Used double sided cooling , mounting pad with large heatsink.
- ④ TC measured with thermocouple mounted to top (Drain) of part.

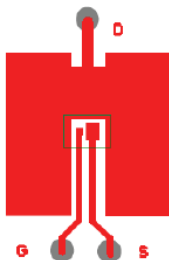

① Surface mounted on 1 in. square Cu board (still air).

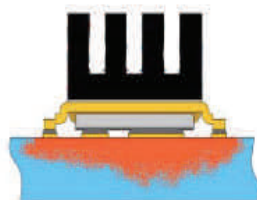

② Mounted to a PCB with small clip heatsink (still air)

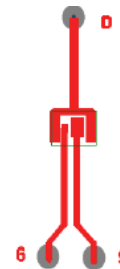

③ Mounted on minimum footprint full size board with metalized back and with small clip heatsink (still air)

Dynamic @ $T_J = 25^\circ\text{C}$ (unless otherwise specified)

Symbol	Parameter	Min.	Typ.	Max.	Units	Conditions
g_{fs}	Forward Transconductance	190	—	—	S	$V_{DS} = 10\text{V}$, $I_D = 70\text{A}$
Q_g	Total Gate Charge	—	120	180	nC	$I_D = 70\text{A}$ $V_{DS} = 30\text{V}$ $V_{GS} = 10\text{V}$ ④
Q_{gs}	Gate-to-Source Charge	—	32	—		
Q_{gd}	Gate-to-Drain ("Miller") Charge	—	36	—		
Q_{sync}	Total Gate Charge Sync. ($Q_g - Q_{gd}$)	—	84	—		
$t_{d(on)}$	Turn-On Delay Time	—	20	—	ns	$V_{DD} = 30\text{V}$ $I_D = 30\text{A}$ $R_G = 2.7\Omega$ $V_{GS} = 10\text{V}$ ④
t_r	Rise Time	—	38	—		
$t_{d(off)}$	Turn-Off Delay Time	—	53	—		
t_f	Fall Time	—	21	—		
C_{iss}	Input Capacitance	—	6510	—	pF	$V_{GS} = 0\text{V}$ $V_{DS} = 25\text{V}$ $f = 1.0\text{MHz}$ $V_{GS} = 0\text{V}$, $V_{DS} = 0\text{V}$ to 48V ⑥ $V_{GS} = 0\text{V}$, $V_{DS} = 0\text{V}$ to 48V ⑤
C_{oss}	Output Capacitance	—	610	—		
C_{rss}	Reverse Transfer Capacitance	—	360	—		
C_{oss} eff. (ER)	Effective Output Capacitance (Energy Related)	—	620	—		
C_{oss} eff. (TR)	Effective Output Capacitance (Time Related)	—	770	—		

Diode Characteristics

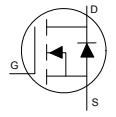
Symbol	Parameter	Min.	Typ.	Max.	Units	Conditions
I_S	Continuous Source Current (Body Diode)	—	—	105	A	MOSFET symbol showing the integral reverse p-n junction diode. 
I_{SM}	Pulsed Source Current (Body Diode) ①	—	—	460		
V_{SD}	Diode Forward Voltage	—	—	1.2	V	$T_J = 25^\circ\text{C}$, $I_S = 70\text{A}$, $V_{GS} = 0\text{V}$ ④
dv/dt	Peak Diode Recovery ③	—	4.1	—	V/ns	$T_J = 150^\circ\text{C}$, $I_S = 70\text{A}$, $V_{DS} = 60\text{V}$
t_{rr}	Reverse Recovery Time	—	41	—	ns	$T_J = 25^\circ\text{C}$ $V_R = 51\text{V}$, $T_J = 125^\circ\text{C}$ $I_F = 70\text{A}$
Q_{rr}	Reverse Recovery Charge	—	55	—		
		—	71	—	nC	$T_J = 25^\circ\text{C}$ $di/dt = 100\text{A}/\mu\text{s}$ ④ $T_J = 125^\circ\text{C}$
I_{RRM}	Reverse Recovery Current	—	2.5	—	A	$T_J = 25^\circ\text{C}$

Notes:

- ① Repetitive rating; pulse width limited by max. junction temperature.
- ② Limited by T_J max, starting $T_J = 25^\circ\text{C}$, $L = 34\mu\text{H}$
 $R_G = 50\Omega$, $I_{AS} = 70\text{A}$, $V_{GS} = 10\text{V}$.
- ③ $I_{SD} \leq 70\text{A}$, $di/dt \leq 980\text{A}/\mu\text{s}$, $V_{DD} \leq V_{(BR)DSS}$, $T_J \leq 150^\circ\text{C}$.
- ④ Pulse width $\leq 400\mu\text{s}$; duty cycle $\leq 2\%$.
- ⑤ C_{oss} eff. (TR) is a fixed capacitance that gives the same charging time as C_{oss} while V_{DS} is rising from 0 to $80\% V_{DSS}$.
- ⑥ C_{oss} eff. (ER) is a fixed capacitance that gives the same energy as C_{oss} while V_{DS} is rising from 0 to $80\% V_{DSS}$.
- ⑦ When mounted on 1" square PCB (FR-4 or G-10 Material). For recommended footprint and soldering techniques refer to application note #AN-994.
- ⑧ R_θ is measured at T_J approximately 90°C .
- ⑨ Limited by T_J max, starting $T_J = 25^\circ\text{C}$, $L = 1\text{mH}$, $R_G = 50\Omega$, $I_{AS} = 17\text{A}$, $V_{GS} = 10\text{V}$.

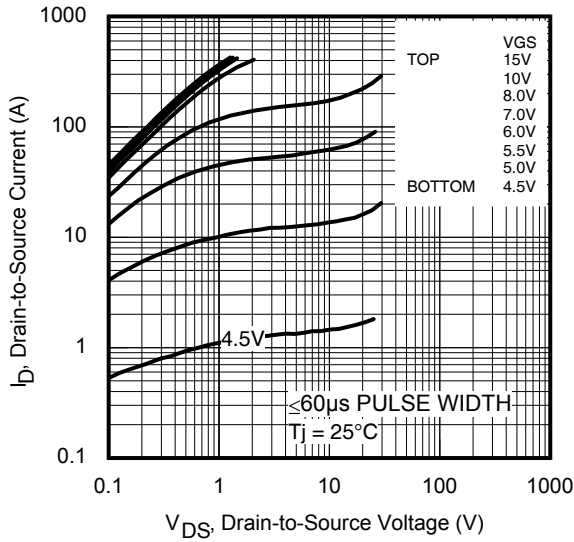
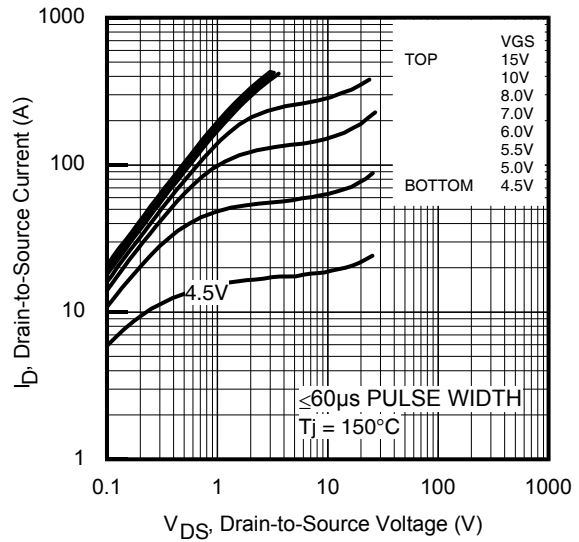
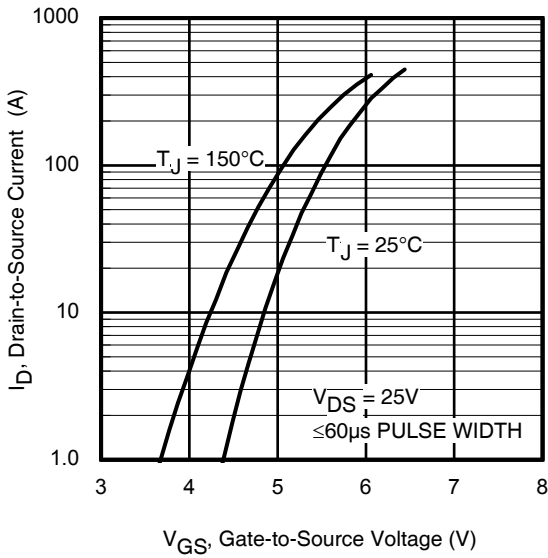
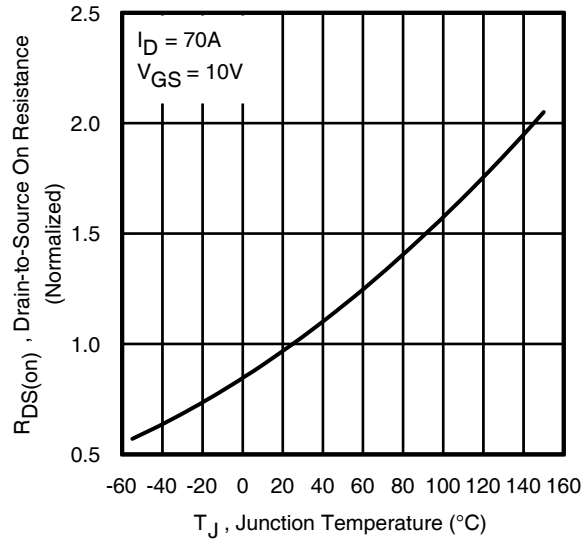
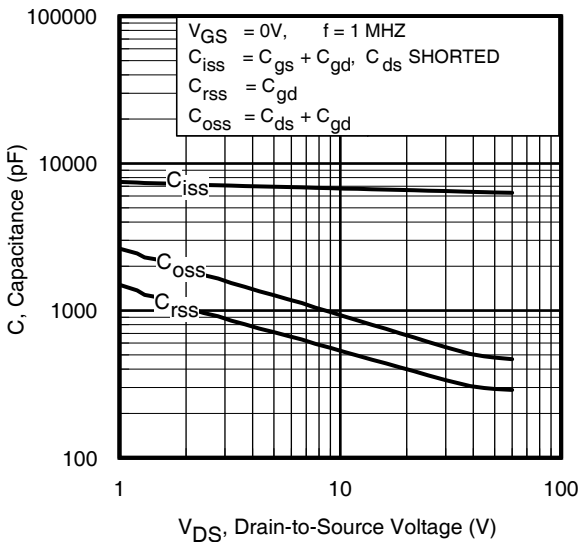
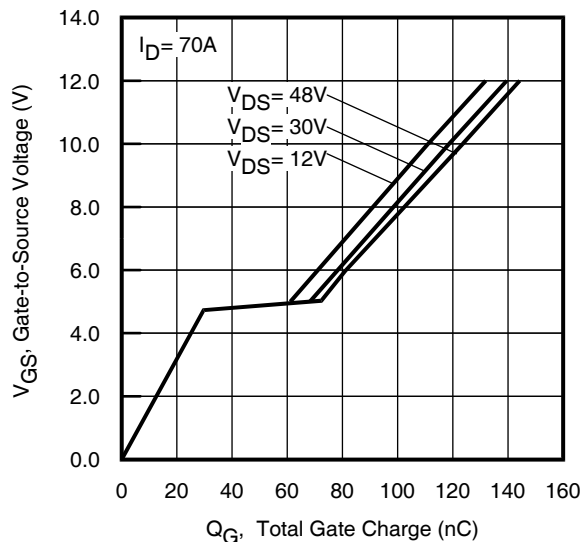
Fig 3. Typical Output Characteristics

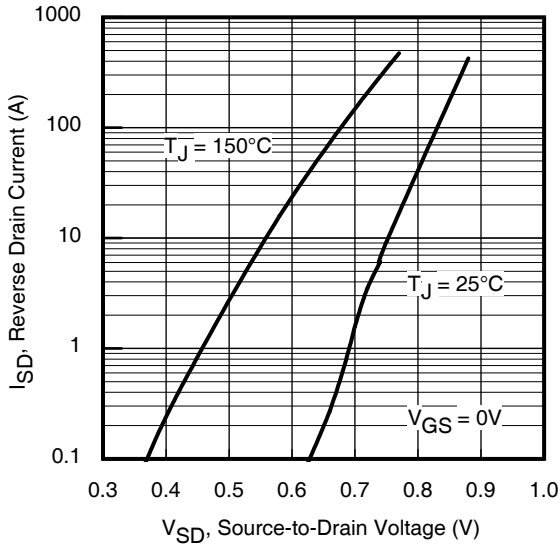
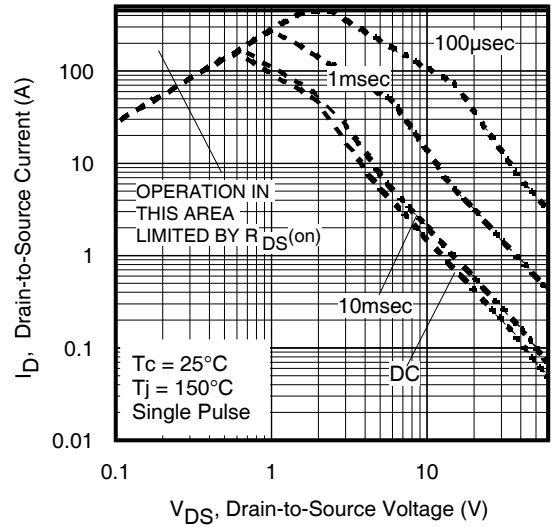
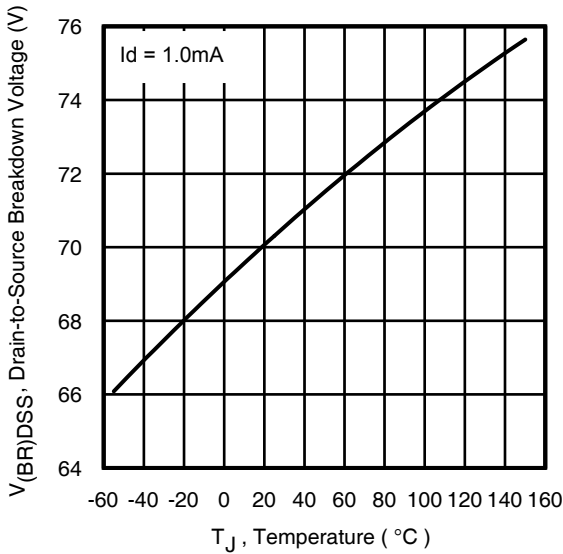
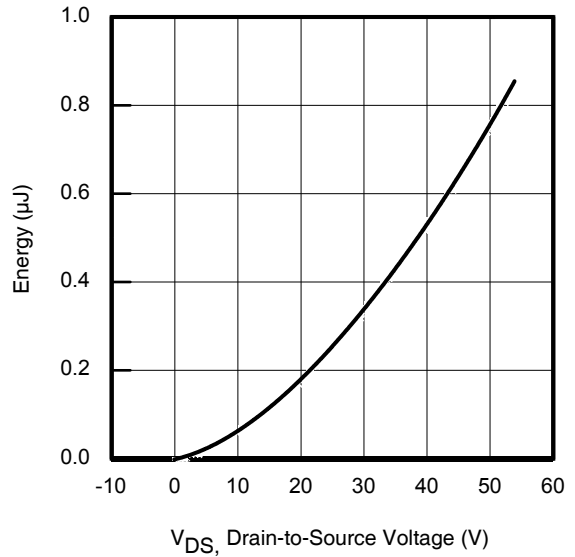
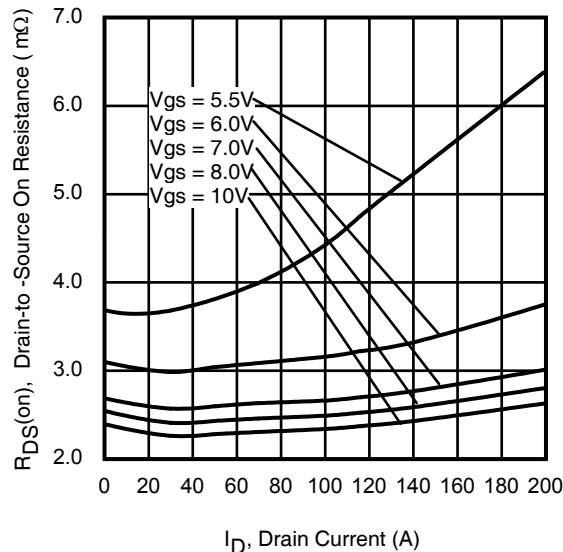
Fig 4. Typical Output Characteristics

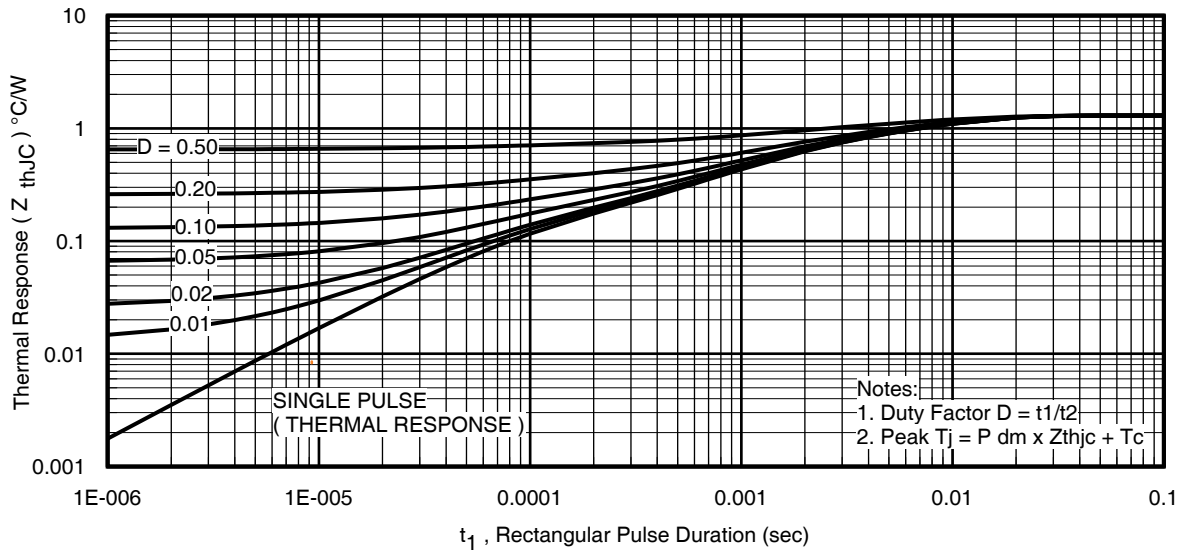
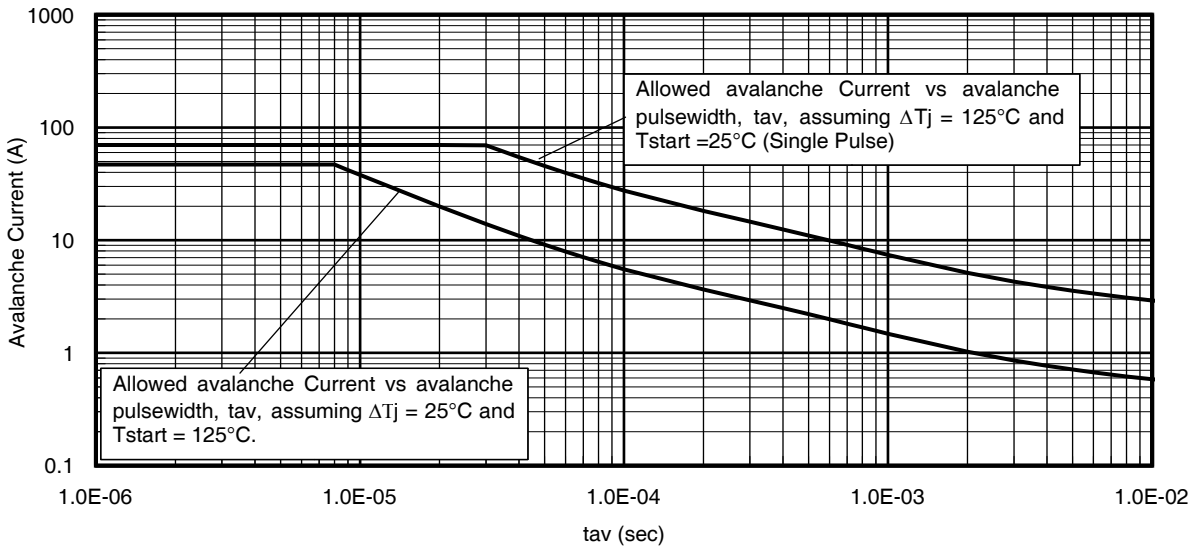
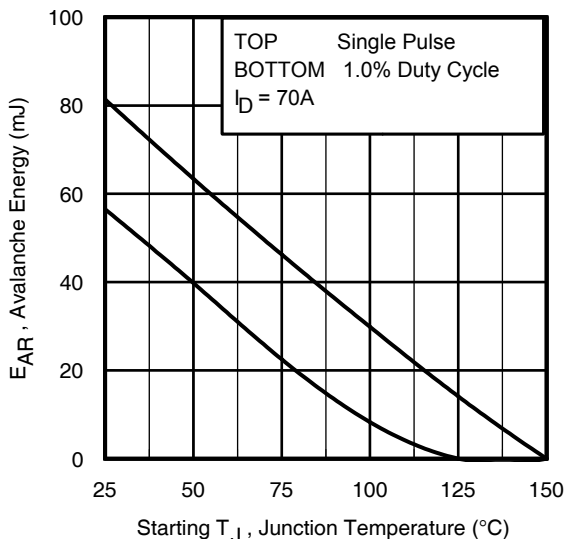
Fig 5. Typical Transfer Characteristics

Fig 6. Normalized On-Resistance vs. Temperature

Fig 7. Typical Capacitance vs. Drain-to-Source Voltage

Fig 8. Typical Gate Charge vs. Gate-to-Source Voltage

Fig 9. Typical Source-Drain Diode Forward Voltage

Fig 10. Maximum Safe Operating Area

Fig 11. Drain-to-Source Breakdown Voltage

Fig 12. Typical C_{oss} Stored Energy

Fig 13. Typical On-Resistance vs. Drain Current

Fig 14. Maximum Effective Transient Thermal Impedance, Junction-to-Case

Fig 15. Avalanche Current vs. Pulse Width

Fig 16. Maximum Avalanche Energy vs. Temperature
**Notes on Repetitive Avalanche Curves , Figures 15, 16:
(For further info, see AN-1005 at www.irf.com)**

1. Avalanche failures assumption:
Purely a thermal phenomenon and failure occurs at a temperature far in excess of T_{jmax} . This is validated for every part type.
2. Safe operation in Avalanche is allowed as long as T_{jmax} is not exceeded.
3. Equation below based on circuit and waveforms shown in Figures 23a, 23b.
4. $P_{D(ave)}$ = Average power dissipation per single avalanche pulse.
5. BV = Rated breakdown voltage (1.3 factor accounts for voltage increase during avalanche).
6. I_{av} = Allowable avalanche current.
7. ΔT = Allowable rise in junction temperature, not to exceed T_{jmax} (assumed as 25°C in Figure 14, 15).

 t_{av} = Average time in avalanche.

 D = Duty cycle in avalanche = $t_{av} \cdot f$
 $Z_{thJC}(D, t_{av})$ = Transient thermal resistance, see Figures 13)

$$P_{D(ave)} = 1/2 (1.3 \cdot BV \cdot I_{av}) = \Delta T / Z_{thJC}$$

$$I_{av} = 2\Delta T / [1.3 \cdot BV \cdot Z_{th}]$$

$$E_{AS(AR)} = P_{D(ave)} \cdot t_{av}$$

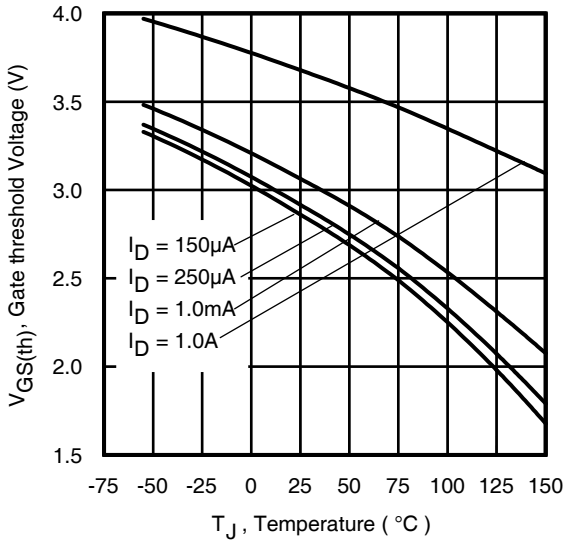
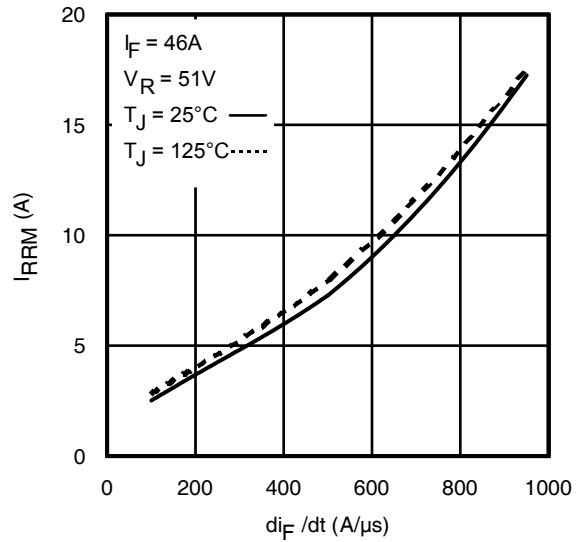
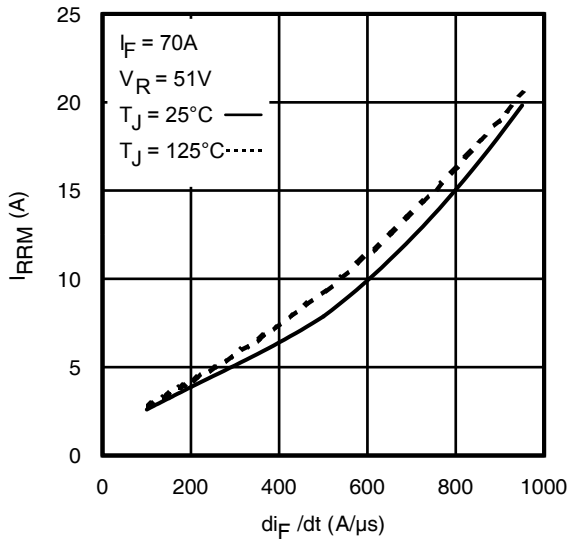
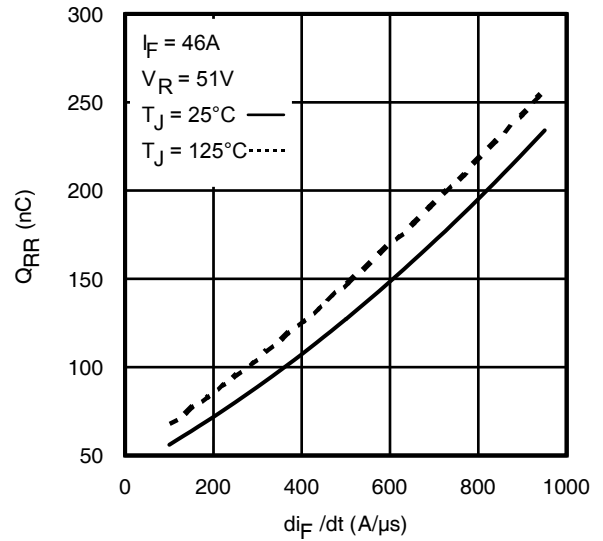
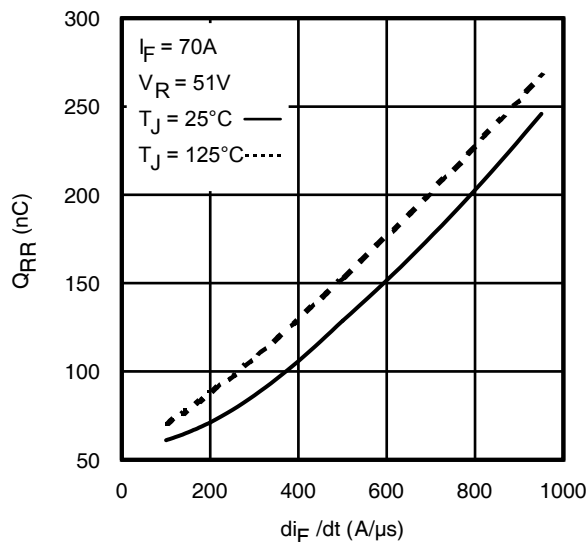
Fig 17. Threshold Voltage vs. Temperature

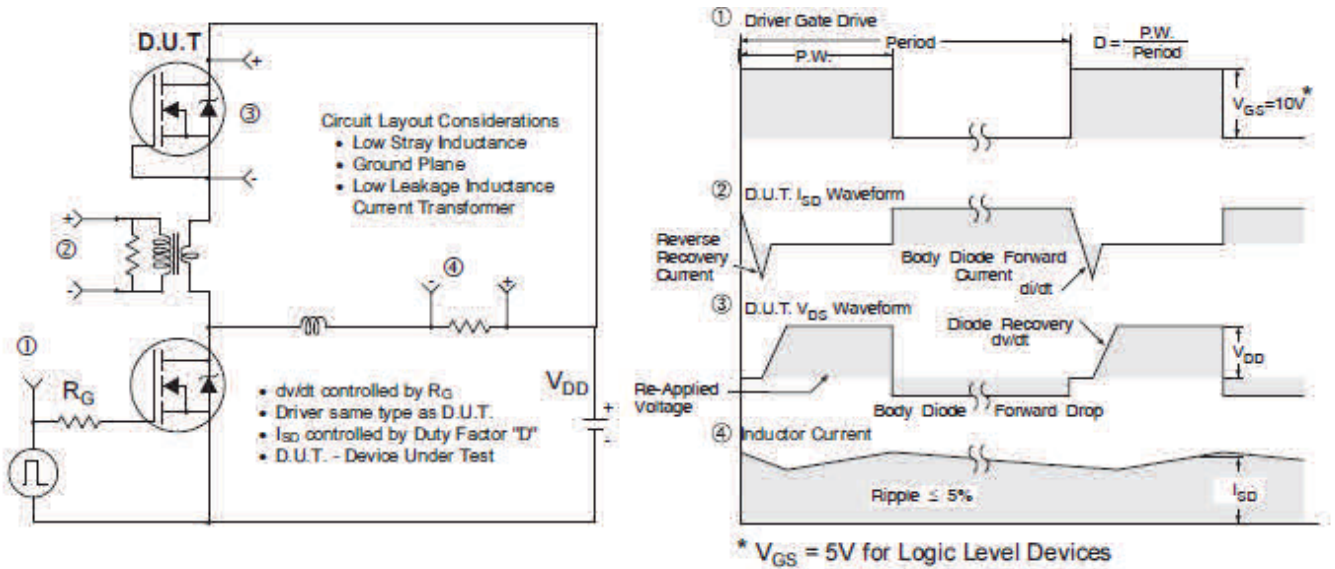
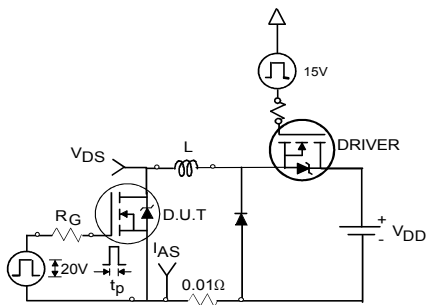
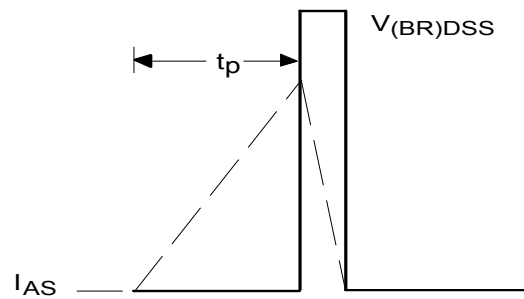
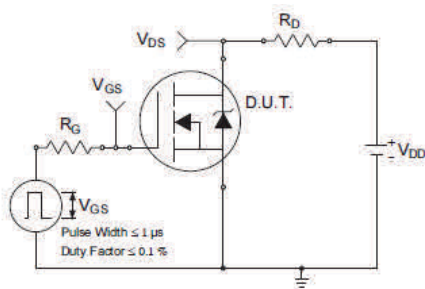
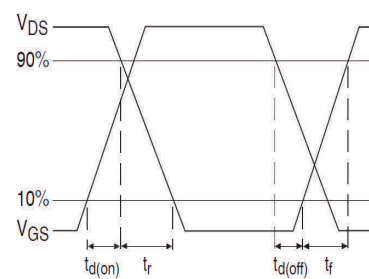
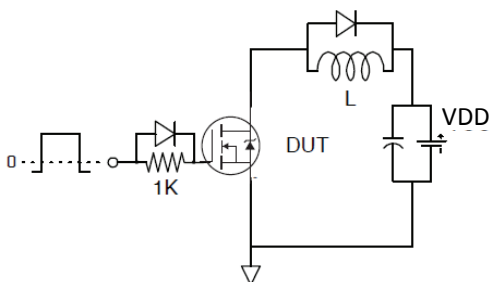
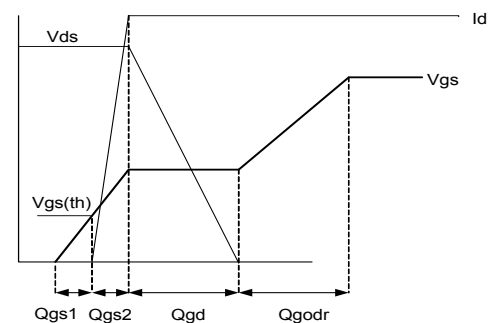
Fig 18. Typical Recovery Current vs. dif/dt

Fig 19. Typical Recovery Current vs. dif/dt

Fig 20. Typical Stored Charge vs. dif/dt

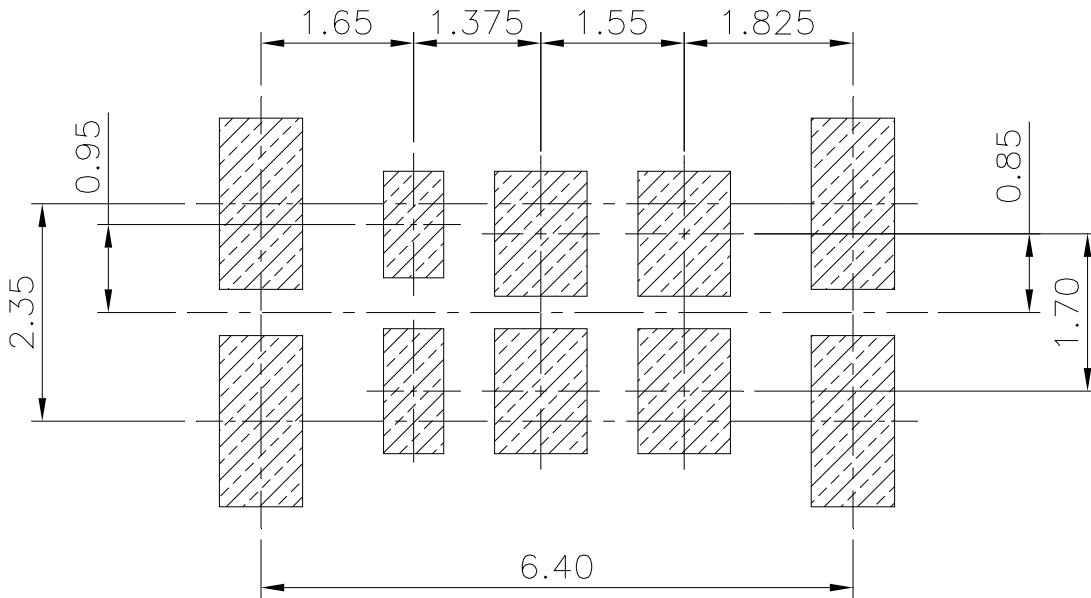
Fig 21. Typical Stored Charge vs. dif/dt

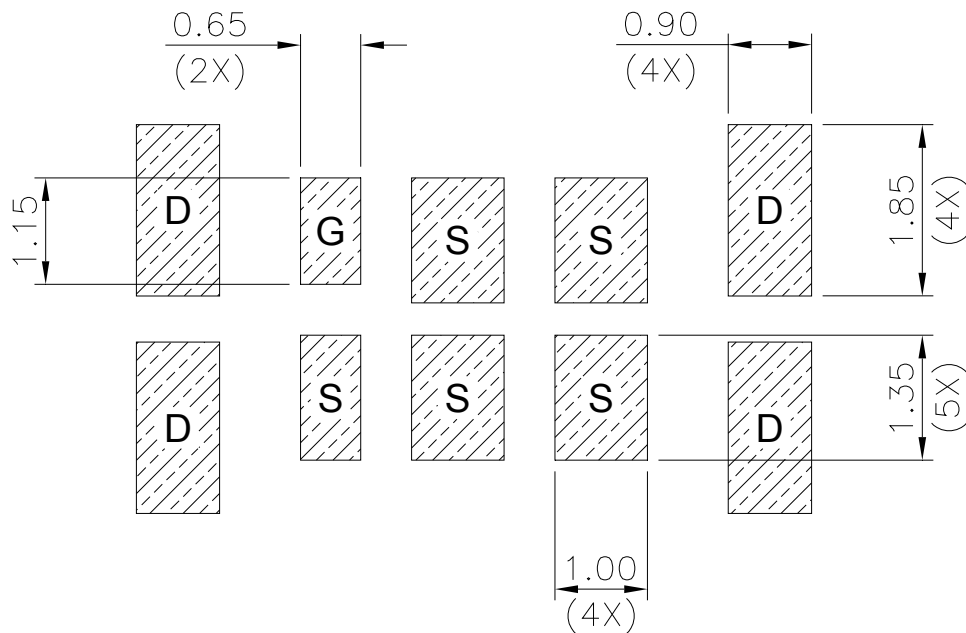

Fig 22. Peak Diode Recovery dv/dt Test Circuit for N-Channel HEXFET® Power MOSFETs

Fig 23a. Unclamped Inductive Test Circuit

Fig 23b. Unclamped Inductive Waveforms

Fig 24a. Switching Time Test Circuit

Fig 24b. Switching Time Waveforms

Fig 25a. Gate Charge Test Circuit

Fig 25b. Gate Charge Waveform

**DirectFET® Board Footprint, ME Outline
(Medium Size Can, E-Designation)**

Please see DirectFET® application note AN-1035 for all details regarding the assembly of DirectFET®. This includes all recommendations for stencil and substrate designs.



G = GATE
D = DRAIN
S = SOURCE



Note: For the most current drawing please refer to IR website at <http://www.irf.com/package/>

**DirectFET® Outline Dimension, ME Outline
(Medium Size Can, E-Designation)**

Please see DirectFET® application note AN-1035 for all details regarding the assembly of DirectFET®. This includes all recommendations for stencil and substrate designs.

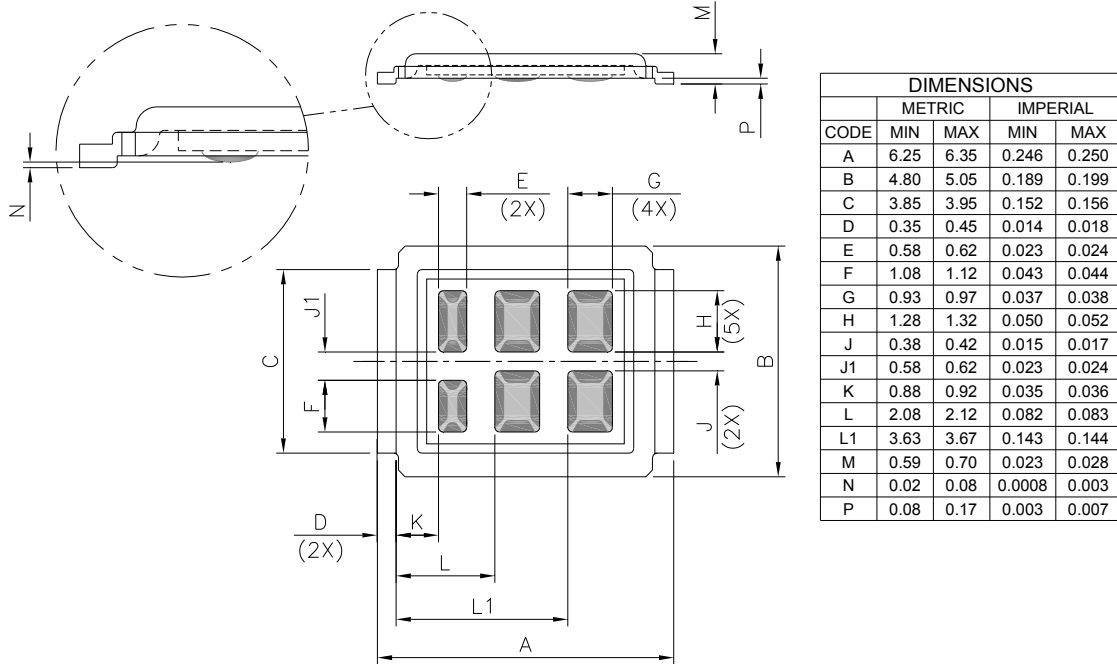

Dimensions are shown in millimeters (inches)

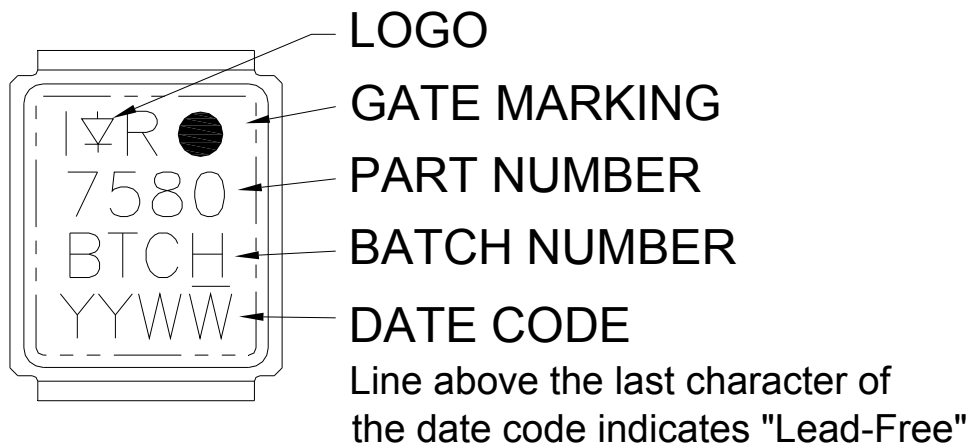
DirectFET® Part Marking

Note: For the most current drawing please refer to IR website at <http://www.irf.com/package/>

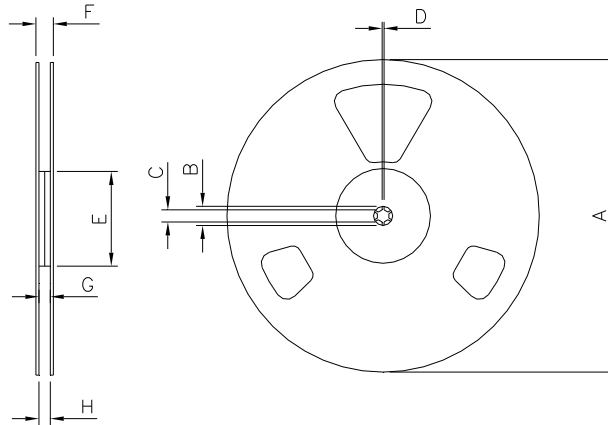
DirectFET® Tape & Reel Dimension (Showing component orientation).

NOTE: Controlling dimensions in mm
 Std reel quantity is 4800 parts. (ordered as IRF7580MTRPbF). For 1000 parts on 7" reel, order IRF7580MTR1PbF

REEL DIMENSIONS								
CODE	STANDARD OPTION (QTY 4800)				TR1 OPTION (QTY 1000)			
	METRIC		IMPERIAL		METRIC		IMPERIAL	
	MIN	MAX	MIN	MAX	MIN	MAX	MIN	MAX
A	330.0	N.C	12.992	N.C	177.77	N.C	6.9	N.C
B	20.2	N.C	0.795	N.C	19.06	N.C	0.75	N.C
C	12.8	13.2	0.504	0.520	13.5	12.8	0.53	0.50
D	1.5	N.C	0.059	N.C	1.5	N.C	0.059	N.C
E	100.0	N.C	3.937	N.C	58.72	N.C	2.31	N.C
F	N.C	18.4	N.C	0.724	N.C	13.50	N.C	0.53
G	12.4	14.4	0.488	0.567	11.9	12.01	0.47	N.C
H	11.9	15.4	0.469	0.606	11.9	12.01	0.47	N.C

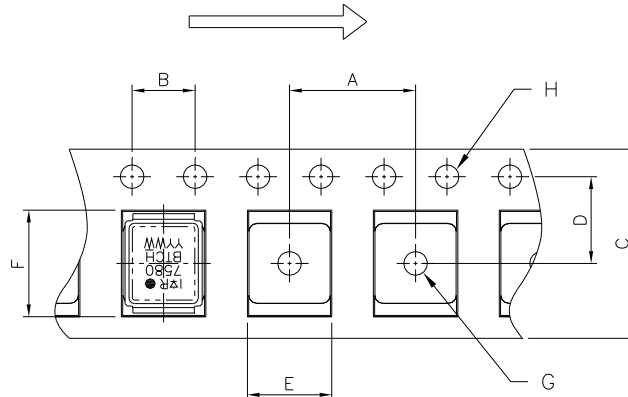
LOADED TAPE FEED DIRECTION

NOTE: CONTROLLING DIMENSIONS IN MM

CODE	DIMENSIONS			
	METRIC		IMPERIAL	
	MIN	MAX	MIN	MAX
A	7.90	8.10	0.311	0.319
B	3.90	4.10	0.154	0.161
C	11.90	12.30	0.469	0.484
D	5.45	5.55	0.215	0.219
E	5.10	5.30	0.201	0.209
F	6.50	6.70	0.256	0.264
G	1.50	N.C	0.059	N.C
H	1.50	1.60	0.059	0.063

Note: For the most current drawing please refer to IR website at <http://www.irf.com/package/>

Qualification Information[†]

Qualification Level	Industrial (per JEDEC JESD47F ^{††} guidelines)	
Moisture Sensitivity Level	DFET 1.5	MSL1 (per JEDEC J-STD-020D ^{††})
RoHS Compliant	Yes	

† Qualification standards can be found at International Rectifier's web site
<http://www.irf.com/product-info/reliability>

†† Applicable version of JEDEC standard at the time of product release.

* Industrial qualification standards except autoclave test conditions.

Revision History

Date	Comments
3/25/2014	<ul style="list-style-type: none"> Corrected figure 6 - Normalized On-Resistance vs. Temperature graph on page 4.
2/19/2015	<ul style="list-style-type: none"> Updated $E_{AS(L=1mH)} = 149mJ$ on page 2 Updated note 9 "Limited by T_{Jmax}, starting $T_J = 25^{\circ}C$, $L = 1mH$, $R_G = 50\Omega$, $I_{AS} = 17A$, $V_{GS} = 10V$" on page 3
05/14/2015	<ul style="list-style-type: none"> Updated registered trademark from DirectFET[™] to DirectFET[®] on page 1,9 and 10.

International
 Rectifier

IR WORLD HEADQUARTERS: 101 N. Sepulveda Blvd., El Segundo, California 90245, USA
 To contact International Rectifier, please visit <http://www.irf.com/whoto-call/>

Mouser Electronics

Authorized Distributor

Click to View Pricing, Inventory, Delivery & Lifecycle Information:

[Infineon:](#)

[IRF7580MTRPBF](#)