

Products Available From



Solid State Relays and I/O Modules
Catalog 1



Automation Controls
Catalog 2



Switches and Sensors
Catalog 3



Motors and Fans
Catalog 4



Pneumatics
Catalog 5

For your copy of the catalogs, contact



Tel: (800) 677-5311 / Fax: (800) 677-3865
www.crouzet-usa.com

Products and specifications subject to change without notice.

Order/Technical Support – Tel: (800) 677-5311 / FAX: (800) 677-3865 / www.crouzet-usa.com



Snap Action Switches:

	83132 / 83133 / 83134 Subminiature Double Break Switches	3/2
	83170 Subminiature Switches	3/6
	83180 Sealed Subminiature Switches	3/10
	83161 Miniature Switches	3/14
	83160 Miniature Positive Break Switches	3/18
	83137 Miniature Side Rotary Switches	3/19
	83106 / 83109 / 83112 / 83154 Double Break Switches	3/20
	83139 Sealed Double Break Switches	3/24
	83169 Sealed Miniature Switches	3/28
	83123 Sealed Flat-Pack Switches	3/31
	81290 Low Force Position Detectors	3/32

Industrial Limit Switches:

	83852 / 83853 Miniature Industrial Limit Switches, Positive Opening	3/34
	83862 Industrial Limit Switches, Positive Opening	3/36
	83870 Miniature Pre-Cabled Limit Switches, Positive Opening	3/40
	83880 Pre-Cabled Limit Switches, Positive Opening	3/42
	83800 Miniature Limit Switches	3/44
	83731 / 83732 / 83733 Automotive Limit Switches	3/46
	83589 Automotive Limit Switches	3/47
	83581 Sealed Limit Switches, Telescopic-Actuator	3/48
	83523 / 83528 Door Interlock Switches	3/50
	83856 / 83857 Manual Reset Positive Opening Miniature Limit Switches	3/52
	83841 Waterproof Limit Switch	3/55
	83863 / 83864 Cable Pull Limit Switches	3/56







Safety (Security) Limit Switches:

	838930 / 838931 Miniature Plastic Key Lock Limit Switches	3/58
	838932 Solenoid Operated Plastic Key Lock Limit Switches	3/60
	838940 Industrial Metal Key Lock Limit Switches	3/62

Products and specifications subject to change without notice.

Order/Technical Support – Tel: (800) 677-5311 / FAX: (800) 677-3865 / www.crouzet-usa.com

Safety (Security) Limit Switches:

	838941 Solenoid Operated Metal Key Lock Limit Switches	3/64
	83893 Hinged Limit Switches	3/66
	838942 Cable Pull Limit Switches	3/68
	838950 / 838951 Foot Switches	3/70
	79697 E-Stop Switches	3/72
	85100 Two-Hand Control Switch	3/73

Proximity Sensors:

	Analog Inductive Proximity Detectors	3/77
	Ø4, M5, Ø6, M8 Inductive Proximity Detectors Cable Output-3 Wire DC Series-Stainless Steel	3/78
	Ø4, M5 M8 Inductive Proximity Detectors Connector Output-3 Wire DC Series-Stainless Steel	3/78
	M12 Inductive Proximity Detectors Cable Output-3 Wire DC Series-Stainless Steel	3/80
	M12 Inductive Proximity Detectors Cable Output-2 Wire AC Series-Stainless Steel	3/80
	M12 Inductive Proximity Detectors Connector Output-3 Wire DC Series-Stainless Steel	3/81
	M12 Inductive Proximity Detectors Connectors Output-2 Wire AC Series-Stainless Steel	3/81
	M12 Inductive Proximity Detectors Cable Output-3 Wire DC Series-Plastic	3/83
	M12 Inductive Proximity Detectors Connector Output-3 Wire DC Series-Plastic	3/83
	M18 Inductive Proximity Detectors Cable Output-3 Wire DC Series-Stainless Steel	3/84
	M18 Inductive Proximity Detectors Cable Output-2 Wire AC Series-Stainless Steel	3/84
	M18 Inductive Proximity Detectors Connector Output-3 Wire DC Series-Stainless Steel	3/84
	M18 Inductive Proximity Detectors Connector Output-2 Wire AC Series-Stainless Steel	3/84
	M18 Inductive Proximity Detectors Cable Output-3 Wire DC Series-Plastic	3/86
	M18 Inductive Proximity Detectors Cable Output-2 Wire AC Series-Plastic	3/86

Products and specifications subject to change without notice.

Order/Technical Support – Tel: (800) 677-5311 / FAX: (800) 677-3865 / www.crouzet-usa.com







Proximity Sensors:

	M18 Inductive Proximity Detectors Connector Output-3 Wire DC Series-Plastic	3/87
	M30 Inductive Proximity Detectors Cable Output-3 Wire DC Series-Stainless Steel	3/88
	M30 Inductive Proximity Detectors Cable Output-2 Wire AC Series-Stainless Steel	3/88
	M30 Inductive Proximity Detectors Connector Output-3 Wire DC Series-Stainless Steel	3/89
	M30 Inductive Proximity Detectors Connector Output-2 Wire AC Series-Stainless Steel	3/89
	M30 Inductive Proximity Detectors Cable Output-3 Wire DC Series-Plastic	3/90
	M30 Inductive Proximity Detectors Cable Output-2 Wire AC Series-Plastic	3/90
	M30 Inductive Proximity Detectors Connector Output-3 Wire DC Series-Plastic	3/91
	Inductive Proximity Detector-Flat Pack 55x35 mm	3/92
	Inductive Proximity Detector 40x40 mm	3/93
	M8 Inductive Proximity Detectors Cable Output-2 Wire DC NAMUR Series-Stainless Steel	3/94
	M18 Inductive Proximity Detectors Cable Output-2 Wire DC NAMUR Series-Stainless Steel	3/94
	M18 Inductive Proximity Detectors Connector Output-2 Wire DC NAMUR Series-Stainless Steel	3/94
	M12 Inductive Proximity Detectors Cable Output-2 Wire DC NAMUR Series-Stainless Steel	3/95
	M12 Inductive Proximity Detectors Connector Output-2 Wire DC NAMUR Series-Stainless Steel	3/95
	M30 Inductive Proximity Detectors Cable Output-2 Wire DC NAMUR Series-Stainless Steel	3/95
	M30 Inductive Proximity Detectors-Connector Output 2 Wire DC NAMUR Series-Stainless Steel	3/95
	Inductive Proximity Detectors for Severe Environments	3/96
	M18 Capacitive Proximity Detectors Cable Output-3 Wire DC Series-Plastic	3/97
	M18 Capacitive Proximity Detectors Cable Output-2 Wire AC Series-Plastic	3/97

Products and specifications subject to change without notice.

Order/Technical Support – Tel: (800) 677-5311 / FAX: (800) 677-3865 / www.crouzet-usa.com

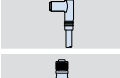
Proximity Sensors:

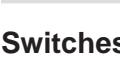
	M30 Capacitive Proximity Detectors Cable Output-2 Wire AC Series-Plastic	3/97
	Capacitive Proximity Detector-Flat Pack 55x35 mm	3/98
	M30 Programmable Capacitive Proximity Detectors Cable Output-4 Wire DC Series-Plastic	3/99
	M30 Programmable Capacitive Proximity Detectors Cable Output-2 Wire AC Series-Plastic	3/99
	M8 Connectors	3/100
	M12 Connectors	3/101
	Mounting Flanges	3/102

Switches and Sensors Technical References:

	Snap Action Switches-Technical Guide	3/104
	Limit Switches-Technical Guide	3/111
	Key-Operated Safety Limit Switches-Technical Guide	3/113
	Inductive Proximity Detectors-Technical Guide	3/115
	Capacitive Proximity Detectors-Technical Guide	3/121

Products and specifications subject to change without notice.

Order/Technical Support – Tel: (800) 677-5311 / FAX: (800) 677-3865 / www.crouzet-usa.com

Index

Part Number	Page	Part Number	Page	Part Number	Page	Part Number	Page
25552953	3/100	79214578	3/64	83161.5SP4136	3/15	83853305	3/35
25552954	3/100	79214579	3/62	83161.6	3/15	83853306	3/35
25552955	3/100	79214579	3/64	83161.8	3/15	83853307	3/35
25552956	3/100	79214580	3/62	83161.9	3/15	83853308	3/35
25552957	3/100	79214580	3/64	83161.9SP4136	3/15	83853311	3/35
25552958	3/100	79214581	3/58	831690	3/29	83853312	3/35
25552959	3/100	79214582	3/58	831694	3/29	83853313	3/35
25552960	3/100	79214583	3/58	831698	3/29	83853314	3/35
25552961	3/100	79214584	3/58	831699	3/29	83853315	3/35
25552962	3/100	79214585	3/58	83170.0	3/7	83853316	3/35
25552963	3/100	79215332	3/45	83170.4	3/7	83853317	3/35
25552964	3/100	79215740	3/14	83170.4SP4967	3/7	83853318	3/35
25552965	3/100	79215740	3/25	83170.9	3/7	83853501	3/34
25552966	3/100	79215740	3/29	83180.0	3/11	83853511	3/34
25552967	3/101	79215741	3/32	83181.0	3/11	83853601	3/35
25552968	3/101	79215742	3/15	83183.0	3/11	83853611	3/35
25552969	3/101	79215742	3/25	83186.0	3/11	83856011	3/53
25552970	3/101	79215742	3/19	835230	3/51	83856111	3/53
25552971	3/101	79215743	3/32	835280	3/51	83856211	3/53
25552972	3/101	79215835	3/15	835283	3/51	83856311	3/53
25552973	3/101	79218454	3/7	835810	3/49	83856312	3/53
25552974	3/101	79218454	3/11	835811	3/49	83856313	3/53
25552975	3/101	79218581	3/25	835890	3/47	83856315	3/53
25552976	3/101	79218581	3/29	835898	3/47	83856316	3/53
25552977	3/101	79218651	3/14	837313	3/46	83856317	3/53
25552978	3/101	79218651	3/25	837323	3/46	83856318	3/53
25552979	3/101	79218651	3/29	837333	3/46	83856511	3/53
25552980	3/101	79250290	3/36	83770025	3/54	83857011	3/53
25552981	3/101	79250291	3/36	83770035	3/54	83857111	3/53
25552982	3/101	79253326	3/7	83777021	3/55	83857211	3/53
25552983	3/101	79253326	3/11	83778021	3/55	83857311	3/53
25552984	3/101	79253327	3/7	83800151	3/45	83857312	3/53
25552989	3/101	79253327	3/11	83801051	3/45	83857313	3/53
25552990	3/101	79253328	3/7	83802051	3/45	83857315	3/53
25552991	3/101	79253328	3/11	83803051	3/45	83857316	3/53
25552992	3/101	79253329	3/7	83805051	3/45	83857317	3/53
26546820	3/102	79253329	3/11	83806051	3/45	83857318	3/53
26546821	3/102	79507524	3/25	83807051	3/45	83862001	3/36
26546822	3/102	79697001	3/73	83852001	3/34	83862011	3/36
26546823	3/102	79697003	3/72	83852011	3/34	83862101	3/36
26546824	3/102	79697004	3/72	83852101	3/34	83862111	3/36
26546825	3/102	79697005	3/72	83852111	3/34	83862201	3/36
26546826	3/102	79697006	3/72	83852201	3/34	83862211	3/36
70500206	3/21	79697008	3/72	83852211	3/34	83862301	3/37
70500208	3/21	79697009	3/72	83852301	3/35	83862302	3/37
70500218	3/21	79697010	3/72	83852302	3/35	83862303	3/37
70500813	3/21	79697011	3/72	83852303	3/35	83862304	3/37
70500828	3/21	79697101	3/72	83852304	3/35	83862305	3/37
70500840	3/21	79697101	3/73	83852305	3/35	83862306	3/37
70500870	3/21	81290001	3/32	83852306	3/35	83862307	3/37
70500888	3/20	81290501	3/32	83852307	3/35	83862308	3/37
70507524	3/15	825233	3/51	83852308	3/35	83862311	3/37
70507524	3/29	831060	3/20	83852311	3/35	83862312	3/37
70507526	3/15	831064	3/21	83852312	3/35	83862313	3/37
70507528	3/15	831067	3/21	83852313	3/35	83862314	3/37
70507529	3/15	831090	3/21	83852314	3/35	83862315	3/37
70507529	3/25	831110	3/21	83852315	3/35	83862316	3/37
70507529	3/29	831115	3/21	83852316	3/35	83862317	3/37
70514131	3/3	831120	3/21	83852317	3/35	83862318	3/37
70514175	3/3	831230	3/31	83852318	3/35	83862501	3/36
70514181	3/3	831320	3/3	83852501	3/34	83862511	3/36
70514182	3/3	831330	3/3	83852511	3/34	83862601	3/37
70514183	3/3	831340	3/3	83852601	3/35	83862611	3/37
70514194	3/3	831370	3/19	83852611	3/35	83863001	3/56
70514559	3/3	831390	3/25	83853001	3/34	83863002	3/56
79210997	3/45	831391	3/25	83853011	3/34	83870102	3/41
79210998	3/45	831392	3/25	83853101	3/34	83870103	3/41
79214571	3/68	831395	3/25	83853111	3/34	83871102	3/41
79214572	3/68	831540	3/21	83853201	3/34	83871103	3/41
79214573	3/68	831607	3/29	83853211	3/34	83872102	3/41
79214574	3/68	83161.1	3/15	83853301	3/35	83872103	3/41
79214576	3/68	83161.2	3/15	83853302	3/35	83873102	3/41
79214577	3/68	83161.3	3/15	83853303	3/35	83873103	3/41
79214578	3/62	83161.5	3/15	83853304	3/35	83874102	3/41

Products and specifications subject to change without notice.

Order/Technical Support – Tel: (800) 677-5311 / FAX: (800) 677-3865 / www.crouzet-usa.com

Index

Part Number	Page	Part Number	Page	Part Number	Page	Part Number	Page
83874103	3/41	84717045	3/83	84717145	3/83	84717275	3/88
83880102	3/43	84717050	3/84	84717150	3/84	84717276	3/88
83880103	3/43	84717051	3/84	84717151	3/84	84717277	3/88
83881102	3/43	84717052	3/85	84717152	3/85	84717278	3/89
83881103	3/43	84717053	3/85	84717153	3/85	84717279	3/89
83882102	3/43	84717054	3/85	84717154	3/85	84717280	3/89
83882103	3/43	84717055	3/85	84717155	3/85	84717281	3/89
83883102	3/43	84717056	3/85	84717156	3/85	84717282	3/89
83883103	3/43	84717057	3/85	84717157	3/85	84717283	3/89
83884102	3/43	84717062	3/86	84717162	3/86	84717284	3/89
83884103	3/43	84717063	3/86	84717163	3/86	84717285	3/89
83893001	3/58	84717064	3/87	84717164	3/87	84717286	3/90
83893010	3/58	84717065	3/87	84717165	3/87	84717287	3/90
83893120	3/58	84717066	3/87	84717166	3/87	84717288	3/90
83893130	3/58	84717067	3/87	84717167	3/87	84717289	3/90
83893201	3/60	84717068	3/87	84717168	3/87	84717290	3/91
83893202	3/60	84717069	3/87	84717169	3/87	84717291	3/91
83893203	3/60	84717074	3/88	84717174	3/88	84717292	3/91
83893301	3/67	84717075	3/88	84717175	3/88	84717293	3/91
83893302	3/67	84717076	3/89	84717176	3/89	84717326	3/80
83893303	3/67	84717077	3/89	84717177	3/89	84717327	3/80
83893401	3/67	84717078	3/89	84717178	3/89	84717328	3/80
83894020	3/62	84717079	3/89	84717179	3/89	84717329	3/80
83894120	3/64	84717080	3/89	84717180	3/89	84717330	3/81
83894121	3/64	84717081	3/89	84717181	3/89	84717331	3/81
83894122	3/64	84717086	3/90	84717186	3/90	84717332	3/81
83894130	3/64	84717087	3/90	84717187	3/90	84717333	3/81
83894131	3/64	84717088	3/91	84717188	3/91	84717338	3/83
83894132	3/64	84717089	3/91	84717189	3/91	84717339	3/83
83894201	3/68	84717090	3/91	84717190	3/91	84717340	3/83
83895001	3/70	84717091	3/91	84717191	3/91	84717341	3/83
83895030	3/70	84717092	3/91	84717192	3/91	84717342	3/83
83895101	3/70	84717093	3/91	84717193	3/91	84717343	3/83
84717000	3/78	84717100	3/78	84717226	3/80	84717344	3/83
84717001	3/78	84717101	3/78	84717227	3/80	84717345	3/83
84717002	3/78	84717102	3/78	84717228	3/80	84717346	3/82
84717003	3/78	84717103	3/78	84717229	3/80	84717347	3/82
84717004	3/79	84717104	3/79	84717230	3/81	84717348	3/82
84717005	3/79	84717105	3/79	84717231	3/81	84717349	3/82
84717006	3/79	84717106	3/79	84717232	3/81	84717350	3/84
84717007	3/79	84717107	3/79	84717233	3/81	84717351	3/84
84717008	3/79	84717108	3/79	84717238	3/83	84717352	3/84
84717009	3/79	84717109	3/79	84717239	3/83	84717353	3/84
84717010	3/78	84717110	3/78	84717240	3/83	84717354	3/85
84717011	3/78	84717111	3/78	84717241	3/83	84717355	3/85
84717012	3/78	84717112	3/78	84717242	3/83	84717356	3/85
84717013	3/78	84717113	3/78	84717243	3/83	84717357	3/85
84717014	3/79	84717114	3/79	84717244	3/83	84717358	3/85
84717015	3/79	84717115	3/79	84717245	3/83	84717359	3/85
84717016	3/79	84717116	3/79	84717246	3/82	84717360	3/85
84717017	3/79	84717117	3/79	84717247	3/82	84717361	3/85
84717018	3/79	84717118	3/79	84717248	3/82	84717362	3/86
84717019	3/79	84717119	3/79	84717249	3/82	84717363	3/86
84717020	3/79	84717120	3/79	84717250	3/84	84717364	3/86
84717021	3/79	84717121	3/79	84717251	3/84	84717365	3/86
84717022	3/78	84717122	3/78	84717252	3/84	84717366	3/87
84717023	3/78	84717123	3/78	84717253	3/84	84717367	3/87
84717024	3/78	84717124	3/78	84717254	3/85	84717368	3/87
84717025	3/78	84717125	3/78	84717255	3/85	84717369	3/87
84717026	3/80	84717126	3/80	84717256	3/85	84717374	3/88
84717027	3/80	84717127	3/80	84717257	3/85	84717375	3/88
84717028	3/81	84717128	3/81	84717258	3/85	84717376	3/88
84717029	3/81	84717129	3/81	84717259	3/85	84717377	3/88
84717030	3/81	84717130	3/81	84717260	3/85	84717378	3/89
84717031	3/81	84717131	3/81	84717261	3/85	84717379	3/89
84717032	3/82	84717132	3/82	84717262	3/86	84717380	3/89
84717033	3/82	84717133	3/82	84717263	3/86	84717381	3/89
84717038	3/83	84717138	3/83	84717264	3/86	84717382	3/89
84717039	3/83	84717139	3/83	84717265	3/86	84717383	3/89
84717040	3/83	84717140	3/83	84717266	3/87	84717384	3/89
84717041	3/83	84717141	3/83	84717267	3/87	84717385	3/89
84717042	3/83	84717142	3/83	84717268	3/87	84717386	3/90
84717043	3/83	84717143	3/83	84717269	3/87	84717387	3/90
84717044	3/83	84717144	3/83	84717274	3/88	84717388	3/90

Products and specifications subject to change without notice.

Order/Technical Support – Tel: (800) 677-5311 / FAX: (800) 677-3865 / www.crouzet-usa.com



Index

Part Number	Page	Part Number	Page
84717389	3/90	84718506	3/97
84717390	3/91	84718508	3/97
84717391	3/91	84718510	3/97
84717392	3/91	84718511	3/97
84717393	3/91	84718524	3/99
84717626	3/80	84718526	3/99
84717627	3/80	84718528	3/99
84717628	3/81	84718530	3/99
84717629	3/81	84718532	3/99
84717630	3/81	84718534	3/99
84717631	3/81	84718572	3/98
84717632	3/82	84718574	3/98
84717633	3/82	84718578	3/98
84717646	3/82	84718580	3/98
84717647	3/82	84718588	3/97
84717648	3/82	84718589	3/97
84717649	3/82	84799801	3/96
84717650	3/84	84799802	3/96
84717651	3/84	84799803	3/96
84717652	3/84	84799804	3/96
84717653	3/84	85100291	3/73
84717654	3/85	85100292	3/73
84717655	3/85	85100293	3/73
84717656	3/85	IMB1805T	3/77
84717657	3/85		
84717662	3/86		
84717663	3/86		
84717664	3/87		
84717665	3/87		
84717670	3/84		
84717671	3/84		
84717672	3/84		
84717673	3/84		
84717674	3/88		
84717675	3/88		
84717676	3/88		
84717677	3/88		
84717678	3/89		
84717679	3/89		
84717680	3/88		
84717681	3/88		
84717684	3/89		
84717685	3/89		
84717686	3/90		
84717687	3/90		
84717688	3/91		
84717689	3/91		
84717694	3/89		
84717695	3/89		
84717707	3/94		
84717709	3/94		
84717731	3/95		
84717733	3/95		
84717743	3/95		
84717745	3/95		
84717755	3/94		
84717757	3/94		
84717767	3/94		
84717769	3/94		
84717779	3/95		
84717781	3/95		
84717791	3/95		
84717793	3/95		
84718006	3/93		
84718008	3/93		
84718010	3/93		
84718024	3/92		
84718026	3/92		
84718030	3/92		
84718032	3/92		
84718036	3/92		
84718038	3/92		
84718042	3/92		
84718044	3/92		

Products and specifications subject to change without notice.

Order/Technical Support – Tel: (800) 677-5311 / FAX: (800) 677-3865 / www.crouzet-usa.com

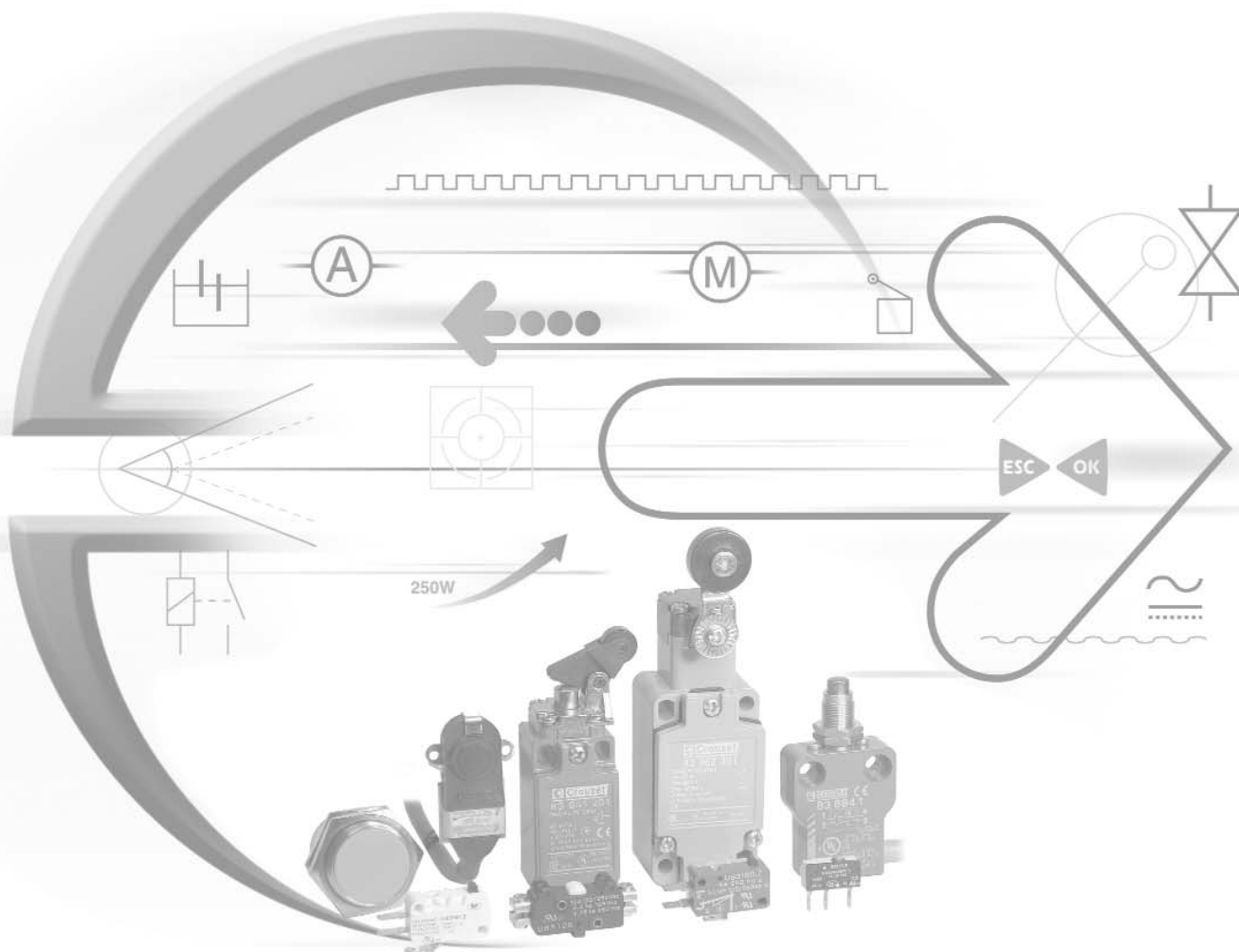

Snap Action Switches



Products and specifications subject to change without notice.

Order/Technical Support – Tel: (800) 677-5311 / FAX: (800) 677-3865 / www.crouzet-usa.com

General specifications

Layout



- The NO and NC circuits must both be of the same polarity.

Components

Material

- Case : glass filled polyamide
- Contacts : silver
- Terminals: copper-nickel

Actuator

- Plain : stainless steel
- roller: nylon

Accessories : stainless steel

Operating curve

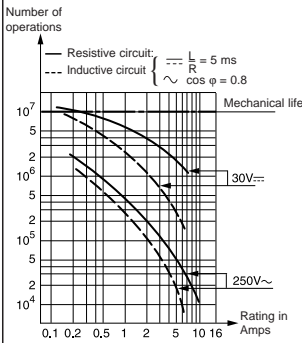

Approvals UL (E42016), CSA (LR - 20918) for others, please consult us.

Types

Features

Electrical characteristics

	Nominal	A
Current rating at 125-250 V		
Thermal		A

Mechanical characteristics

Operating force - max.	N (oz)
Release force min.	N (oz)
Overtravel max. - force	N (oz)
Maximum rest position	mm (in)
Tripping point	mm (in)
Movement differential	mm (in)
Overtravel - min.	mm (in)
Operating temperature	°C (°F)
Mechanical life	Operations
Contact gap	mm (in)
Weight	g (oz)

Contact Type

C (Form C) SPDT-DB

Connections

- 83 132 : solder connection -1- only
- 83 133 : solder connection -1- only
- 83 134 : printed circuit board -2- only

Actuators and mounting positions-Factory Mounted Only

Part numbers for standard actuators

Actuators-Length mm (in)

Tripping point	mm (in)
Operating force max.	N (oz)
Release force min.	N (oz)
Pre-travel - max.	mm (in)
Movement differential	mm (in)
Total travel max.	mm (in)

Part numbers for standard actuators

Actuators-Length mm (in)

Tripping point	mm (in)
Operating force - max.	N (oz)
Release force - min.	N (oz)
Pre-travel - max.	mm (in)
Movement differential	mm (in)
Total travel max.	mm (in)

Other information

Also available: 1) Bi-stable operation
2) NC or NO contacts
3) Custom Actuators

Please consult us for other actuators.

Normally stocked items

Catalog products produced to order

Products and specifications subject to change without notice.

Order/Technical Support – Tel: (800) 677-5311 / FAX: (800) 677-3865 / www.crouzet-usa.com



1		
83 132 0	83 133 0	83 134 0
Side terminals	Base terminals	Face terminals
5	5	5
11	11	11
1.6 (5.6)	1.6 (5.6)	1.6 (5.6)
0.4 (1.4)	0.4 (1.4)	0.4 (1.4)
10 (35.3)	10 (35.3)	10 (35.3)
8.45 (.33)	8.45 (.33)	8.10 (.32)
7.7 ^{+0.2} (.30 ^{-0.008})	7.7 ^{+0.2} (.30 ^{-0.008})	7.35 ^{+0.25} (.29 ^{-0.10})
0.45 (.018)	0.45 (.018)	0.45 (.018)
0.3 (.012)	0.3 (.012)	0.3 (.012)
-20 +125 (-4 to +257)	-20 +125 (-4 to +257)	-20 +125 (-4 to +257)
10 ⁷	10 ⁷	10 ⁷
0.3 x 2 (.012 x 2)	0.3 x 2 (.012 x 2)	0.3 x 2 (.012 x 2)
1.8 (.06)	1.8 (.06)	1.8 (.06)

2		
C	C	C

1 solder tags can accept quick connects .11" x .02"
2 for printed circuit boards

4																																																																																																			
L 70 514 175	C 70 514 194	E 70 514 181	F 70 514 182																																																																																																
Flat 54A R14.75 (.58)	Flat 54A R35.75 (1.41)	Tip-mounted in-line roller 54E R7.5 (.3)	Tip-mounted in-line roller 54E R14.1 (.56)																																																																																																
<table border="1"> <tr><td>83 132 0</td><td></td><td></td></tr> <tr><td>83 133 0</td><td>83 134 0</td><td></td></tr> <tr><td>9.5^{+0.8} (.374^{+0.031})</td><td>9.2^{+0.8} (.362^{+0.031})</td><td></td></tr> <tr><td>0.18 (.6)</td><td></td><td></td></tr> <tr><td>0.16 (.5)</td><td></td><td></td></tr> <tr><td>2.15 (.085)</td><td></td><td></td></tr> <tr><td>1^{+0.3} (.04^{+0.001})</td><td></td><td></td></tr> <tr><td>2.8 (.11)</td><td></td><td></td></tr> </table>	83 132 0			83 133 0	83 134 0		9.5 ^{+0.8} (.374 ^{+0.031})	9.2 ^{+0.8} (.362 ^{+0.031})		0.18 (.6)			0.16 (.5)			2.15 (.085)			1 ^{+0.3} (.04 ^{+0.001})			2.8 (.11)			<table border="1"> <tr><td>83 132 0</td><td></td><td></td></tr> <tr><td>83 133 0</td><td>83 134 0</td><td></td></tr> <tr><td>10^{+1.5} (.413^{+0.06})</td><td>9.7^{+1.5} (.382^{+0.06})</td><td></td></tr> <tr><td>0.34 (1.2)</td><td></td><td></td></tr> <tr><td>0.06 (.2)</td><td></td><td></td></tr> <tr><td>5.15 (.203)</td><td></td><td></td></tr> <tr><td>2.1^{+0.65} (.083^{+0.026})</td><td></td><td></td></tr> <tr><td>6.8 (.268)</td><td></td><td></td></tr> </table>	83 132 0			83 133 0	83 134 0		10 ^{+1.5} (.413 ^{+0.06})	9.7 ^{+1.5} (.382 ^{+0.06})		0.34 (1.2)			0.06 (.2)			5.15 (.203)			2.1 ^{+0.65} (.083 ^{+0.026})			6.8 (.268)			<table border="1"> <tr><td>83 132 0</td><td></td><td></td></tr> <tr><td>83 133 0</td><td>83 134 0</td><td></td></tr> <tr><td>14.2^{+0.3} (.56^{+0.012})</td><td>13.9^{+0.3} (.547^{+0.012})</td><td></td></tr> <tr><td>1.6 (5.6)</td><td></td><td></td></tr> <tr><td>0.32 (1.1)</td><td></td><td></td></tr> <tr><td>1.1 (.043)</td><td></td><td></td></tr> <tr><td>0.5^{+0.15} (.02^{+0.006})</td><td></td><td></td></tr> <tr><td>1.45 (.057)</td><td></td><td></td></tr> </table>	83 132 0			83 133 0	83 134 0		14.2 ^{+0.3} (.56 ^{+0.012})	13.9 ^{+0.3} (.547 ^{+0.012})		1.6 (5.6)			0.32 (1.1)			1.1 (.043)			0.5 ^{+0.15} (.02 ^{+0.006})			1.45 (.057)			<table border="1"> <tr><td>83 132 0</td><td></td><td></td></tr> <tr><td>83 133 0</td><td>83 134 0</td><td></td></tr> <tr><td>15.5^{+0.8} (.61^{+0.031})</td><td>15.2^{+0.8} (.6^{+0.031})</td><td></td></tr> <tr><td>0.8 (2.8)</td><td></td><td></td></tr> <tr><td>0.17 (.6)</td><td></td><td></td></tr> <tr><td>2.05 (.081)</td><td></td><td></td></tr> <tr><td>0.95^{+0.3} (.037^{+0.001})</td><td></td><td></td></tr> <tr><td>2.7 (.106)</td><td></td><td></td></tr> </table>	83 132 0			83 133 0	83 134 0		15.5 ^{+0.8} (.61 ^{+0.031})	15.2 ^{+0.8} (.6 ^{+0.031})		0.8 (2.8)			0.17 (.6)			2.05 (.081)			0.95 ^{+0.3} (.037 ^{+0.001})			2.7 (.106)		
83 132 0																																																																																																			
83 133 0	83 134 0																																																																																																		
9.5 ^{+0.8} (.374 ^{+0.031})	9.2 ^{+0.8} (.362 ^{+0.031})																																																																																																		
0.18 (.6)																																																																																																			
0.16 (.5)																																																																																																			
2.15 (.085)																																																																																																			
1 ^{+0.3} (.04 ^{+0.001})																																																																																																			
2.8 (.11)																																																																																																			
83 132 0																																																																																																			
83 133 0	83 134 0																																																																																																		
10 ^{+1.5} (.413 ^{+0.06})	9.7 ^{+1.5} (.382 ^{+0.06})																																																																																																		
0.34 (1.2)																																																																																																			
0.06 (.2)																																																																																																			
5.15 (.203)																																																																																																			
2.1 ^{+0.65} (.083 ^{+0.026})																																																																																																			
6.8 (.268)																																																																																																			
83 132 0																																																																																																			
83 133 0	83 134 0																																																																																																		
14.2 ^{+0.3} (.56 ^{+0.012})	13.9 ^{+0.3} (.547 ^{+0.012})																																																																																																		
1.6 (5.6)																																																																																																			
0.32 (1.1)																																																																																																			
1.1 (.043)																																																																																																			
0.5 ^{+0.15} (.02 ^{+0.006})																																																																																																			
1.45 (.057)																																																																																																			
83 132 0																																																																																																			
83 133 0	83 134 0																																																																																																		
15.5 ^{+0.8} (.61 ^{+0.031})	15.2 ^{+0.8} (.6 ^{+0.031})																																																																																																		
0.8 (2.8)																																																																																																			
0.17 (.6)																																																																																																			
2.05 (.081)																																																																																																			
0.95 ^{+0.3} (.037 ^{+0.001})																																																																																																			
2.7 (.106)																																																																																																			
B 70 514 559	A 70 514 131	G 70 514 183																																																																																																	
Simulated Roller 54B R13.7 (.54)	Flat 54A R7.75 (.30)	Tip-mounted in-line roller 54E R34.4 (1.35)																																																																																																	
<table border="1"> <tr><td>83 132 0</td><td></td><td></td></tr> <tr><td>83 133 0</td><td>83 134 0</td><td></td></tr> <tr><td>12.7^{+0.8} (.5^{+0.031})</td><td>12.4^{+0.8} (.49^{+0.031})</td><td></td></tr> <tr><td>0.85 (3)</td><td></td><td></td></tr> <tr><td>0.18 (.6)</td><td></td><td></td></tr> <tr><td>2.05 (.081)</td><td></td><td></td></tr> <tr><td>0.95^{+0.3} (.037^{+0.001})</td><td></td><td></td></tr> <tr><td>2.7 (.106)</td><td></td><td></td></tr> </table>	83 132 0			83 133 0	83 134 0		12.7 ^{+0.8} (.5 ^{+0.031})	12.4 ^{+0.8} (.49 ^{+0.031})		0.85 (3)			0.18 (.6)			2.05 (.081)			0.95 ^{+0.3} (.037 ^{+0.001})			2.7 (.106)			<table border="1"> <tr><td>83 132 0</td><td></td><td></td></tr> <tr><td>83 133 0</td><td>83 134 0</td><td></td></tr> <tr><td>8.2^{+0.3} (.32^{+0.01})</td><td>7.9^{+0.3} (.31^{+0.01})</td><td></td></tr> <tr><td>1.55 (5.45)</td><td></td><td></td></tr> <tr><td>0.3 (1.05)</td><td></td><td></td></tr> <tr><td>1.1 (.04)</td><td></td><td></td></tr> <tr><td>.5^{+0.15} (.02^{+0.006})</td><td></td><td></td></tr> <tr><td>1.5 (.06)</td><td></td><td></td></tr> </table>	83 132 0			83 133 0	83 134 0		8.2 ^{+0.3} (.32 ^{+0.01})	7.9 ^{+0.3} (.31 ^{+0.01})		1.55 (5.45)			0.3 (1.05)			1.1 (.04)			.5 ^{+0.15} (.02 ^{+0.006})			1.5 (.06)			<table border="1"> <tr><td>83 132 0</td><td></td><td></td></tr> <tr><td>83 133 0</td><td>83 134 0</td><td></td></tr> <tr><td>16.1^{+1.4} (.63^{+0.05})</td><td>15.8^{+1.4} (.62^{+0.05})</td><td></td></tr> <tr><td>0.34 (1.19)</td><td></td><td></td></tr> <tr><td>0.07 (.25)</td><td></td><td></td></tr> <tr><td>4.9 (1.9)</td><td></td><td></td></tr> <tr><td>2^{+0.6} (.08^{+0.02})</td><td></td><td></td></tr> <tr><td>6.6 (.26)</td><td></td><td></td></tr> </table>	83 132 0			83 133 0	83 134 0		16.1 ^{+1.4} (.63 ^{+0.05})	15.8 ^{+1.4} (.62 ^{+0.05})		0.34 (1.19)			0.07 (.25)			4.9 (1.9)			2 ^{+0.6} (.08 ^{+0.02})			6.6 (.26)																											
83 132 0																																																																																																			
83 133 0	83 134 0																																																																																																		
12.7 ^{+0.8} (.5 ^{+0.031})	12.4 ^{+0.8} (.49 ^{+0.031})																																																																																																		
0.85 (3)																																																																																																			
0.18 (.6)																																																																																																			
2.05 (.081)																																																																																																			
0.95 ^{+0.3} (.037 ^{+0.001})																																																																																																			
2.7 (.106)																																																																																																			
83 132 0																																																																																																			
83 133 0	83 134 0																																																																																																		
8.2 ^{+0.3} (.32 ^{+0.01})	7.9 ^{+0.3} (.31 ^{+0.01})																																																																																																		
1.55 (5.45)																																																																																																			
0.3 (1.05)																																																																																																			
1.1 (.04)																																																																																																			
.5 ^{+0.15} (.02 ^{+0.006})																																																																																																			
1.5 (.06)																																																																																																			
83 132 0																																																																																																			
83 133 0	83 134 0																																																																																																		
16.1 ^{+1.4} (.63 ^{+0.05})	15.8 ^{+1.4} (.62 ^{+0.05})																																																																																																		
0.34 (1.19)																																																																																																			
0.07 (.25)																																																																																																			
4.9 (1.9)																																																																																																			
2 ^{+0.6} (.08 ^{+0.02})																																																																																																			
6.6 (.26)																																																																																																			

∅ No Actuator

Except where otherwise indicated, the actuator is mounted in the position shown in the dimensional drawings (= standard mounting).

To order please specify :

1 Switch Type	2 Contact Type	Example : 831330 C 1 • A L		5 Actuator Position	
		831320	C		1
831330		3 Connection	4 Actuators	R - Right	
831340		1	A		
		2	B		
			C		
			E		
			F		
			G		
			∅		
			L		

Example P/N is 831330, SPDT-DB, solder terminals, A actuator mounted on the left.

Products and specifications subject to change without notice.

Order/Technical Support – Tel: (800) 677-5311 / FAX: (800) 677-3865 / www.crouzet-usa.com

Subminiature Switches

Dimensions

83 132 0

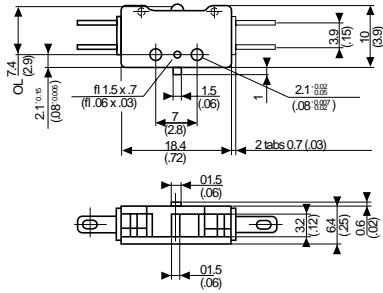

83 133 0

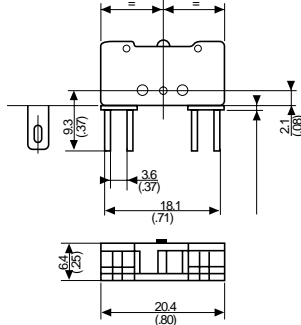

83 134 0

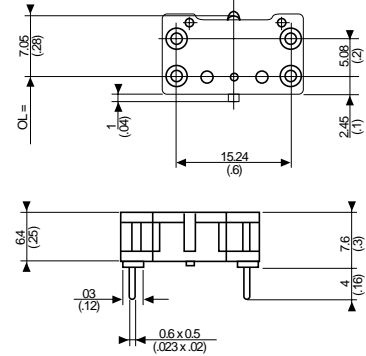

mm(in)

Connections

1

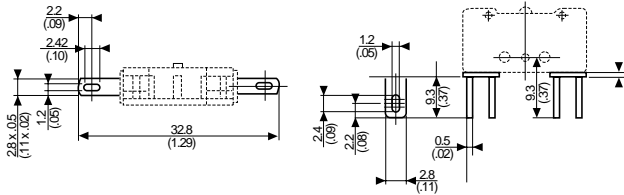

2

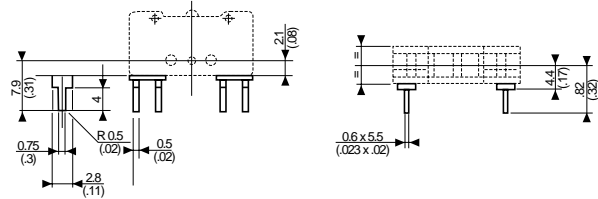

mm(in)

Actuators

Standard mounting

A 70514131 R=7.75 (.30)
 L 70514175 R=14.75 (.58)
 C 70514194 R=35.75 (1.41)

B 70514559 R=13.7 (.54)

E 70514181 R=7.5 (.3)
 F 70514182 R=14.1 (.56)
 G 70514183 R=34.4 (1.35)

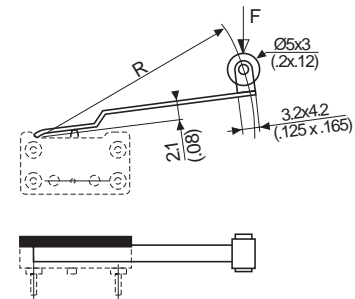
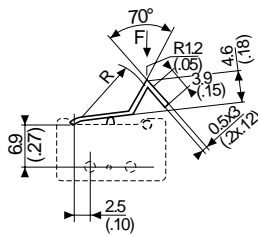
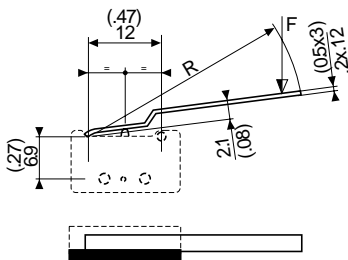

mm(in)



Products and specifications subject to change without notice.

Order/Technical Support – Tel: (800) 677-5311 / FAX: (800) 677-3865 / www.crouzet-usa.com

Subminiature Switches

Actuators and mounting positions – Factory Mounted Only – for Gang Operation

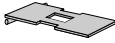
Part numbers for standard actuators – Consult factory for part number

Actuators-Length	mm (in)	2 pole 54A2 R30 (1.18)	3 pole 54A3 R30 (1.18)	Side mounting plate (0.4 mm) 54Y
				
		83 132 0	83 132 0	
		83 133 0 *83 134 0	83 133 0 *83 134 0	
Tripping Point	mm (in)	8.8 ^{+0.8} (.346 ^{+0.03})	8.8 ^{+0.8} (.346 ^{+0.03})	
Operating Force max	N (oz)	0.8 (2.8)	1.2 (4.2)	
Release Force min	N (oz)	0.16 (.6)	0.24 (.8)	
Pre-travel min	mm (in)	4.3 (.17)	4.3 (.17)	
Movement differential	mm (in)	2 ^{+0.55} (.08 ^{+0.02})	2 ^{+0.55} (.08 ^{+0.02})	
Total travel max	mm (in)	5.75 (.23)	5.75 (.23)	

Delivered separately

*For gang operation with 83 132 0 or 83 133 0.

Actuators – For Gang Operation

54A2

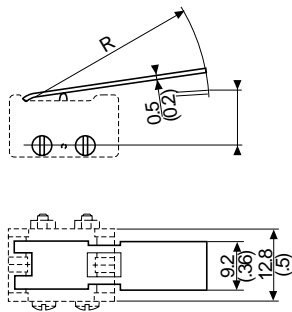

54A3

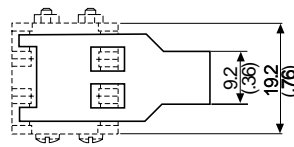

mm(in)

Mounting accessories

83 132 0 - 83 133 0

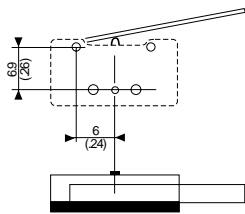

83 134 0

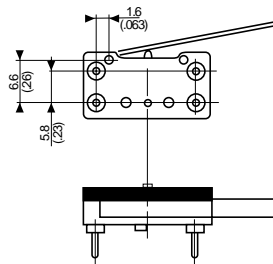

mm(in)

Products and specifications subject to change without notice.

Order/Technical Support – Tel: (800) 677-5311 / FAX: (800) 677-3865 / www.crouzet-usa.com

General specifications

Layout

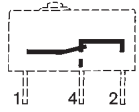

Components

Material

- Case : polyester UL 94 VO
- Button : glass-filled polyamide
- Contacts : AgNi,
gold-plated AgNi (dual-current)
- Terminals : copper-nickel

Actuators

- flat : stainless steel
- roller : stainless steel with polyamide roller

Approvals: NF - UL - cUL

Operating curve

For type 83 170 0

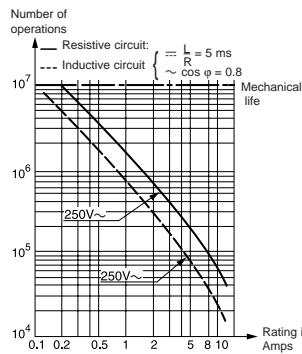

For type 83 170 4

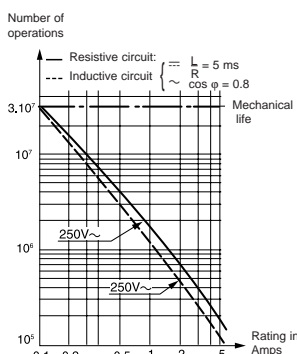

For type 83 170 9

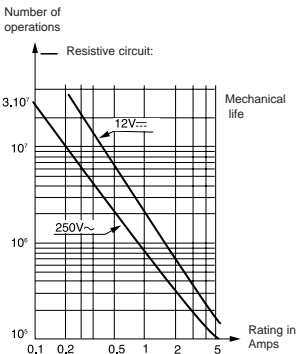

Model 83 170 9 is designed to operate equally well on dual-current (1 mA 4 V minimum) or medium-current (5 A maximum) circuits. However, a given product should only be used to switch one type of circuit during its working life.

Types

Part numbers for standard products (no lever) terminal type	
	1
	2
	3

Features

Electrical characteristics

	Nominal	A
Current rating at 250 V		
	Thermal	A

Mechanical characteristics

Operating force - max.	N (oz.)
Release force - min.	N (oz.)
Total travel force - max.	N (oz.)
Permitted overtravel force - max.	N (oz.)
Maximum rest position	mm (in.)
Tripping point	mm (in.)
Differential travel	mm (in.)
Overtravel - min.	mm (in.)
Ambient operating temperature	°C
Mechanical endurance	Operations
Contact gap	mm (in.)
Weight	g (oz.)

Contact type

- C** (Form C) SPDT
- B** (Form B) SPNC not available in PC terminals
- A** (Form A) SPNO not available in PC terminals

Connections

Actuators and mounting positions

Part numbers for standard actuators

Actuators – Length	mm (in.)
--------------------	----------

Mounting positions

Coefficient	
Tripping point	mm (in.)

Mounting positions

Except where otherwise indicated, actuators are supplied unmounted. For factory mounting, specify mounting position L or R.

- **To calculate force** : take the force quoted for the switch and divide by the coefficient given in the table.
- **To calculate travel** : take the travel quoted for the switch and multiply by the same coefficient.

Mounting accessories for PCB mounting: 5 / 6 / 7 / 8

See page 3/9.

Other information

For other forces, actuators, connections and temperatures, please consult us.

Normally stocked items

Catalog products produced to order

Products and specifications subject to change without notice.

Order/Technical Support – Tel: (800) 677-5311 / FAX: (800) 677-3865 / www.crouzet-usa.com

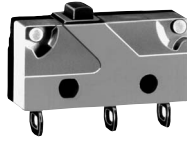

1

83170.0	83170.4	83170.9	83170.4 SP 4967	83170.4	83170.9
831700C1.0	831704C1.0	831709C1.0	831704C2.MBSP	831704C1.MB	831709C1.MB
831700C2.0	831704C2.0	831709C2.0	831704C3.MBSP	831704C2.MB	831709C2.MB
831700C3.0	831704C3.0	831709C3.0	831704C1.MBSP	831704C3.MB	831709C3.MB
High current	Standard	Low current	High force	Standard	Low current
10	5	0.1	5	5	0.1
12.5	6		6	6	
1.5 (5.3)	0.6 (2.2)	0.6 (2.2)	1.5 (5.3)	0.6 (2.2)	0.6 (2.2)
0.3 (1)	0.1 (.04)	0.1 (.04)	0.3 (1)	0.1 (.04)	0.1 (.04)
1.8 (6.3)	1 (3.5)	1 (3.5)	1.8 (6.3)	1 (3.5)	1 (3.5)
10 (35.3)	10 (35.3)	10 (35.3)	10 (35.3)	10 (35.3)	10 (35.3)
9.2 (.36)	9.2 (.36)	9.2 (.36)	10.8 (.425)	10.8 (.425)	10.8 (.425)
8.4 ^{+0.3} (.33 ^{+0.01})	8.4 ^{+0.3} (.33 ^{+0.01})	8.4 ^{+0.3} (.33 ^{+0.01})	9.9 ^{+0.3} (.39 ^{+0.01})	9.9 ^{+0.3} (.39 ^{+0.01})	9.9 ^{+0.3} (.39 ^{+0.01})
0.15 (.006)	0.15 (.006)	0.15 (.006)	0.15 (.006)	0.15 (.006)	0.15 (.006)
0.5 (.02)	0.5 (.02)	0.5 (.02)	0.5 (.02)	0.5 (.02)	0.5 (.02)
-20 to130 (-4 to 266)	-20 to130 (-4 to 266)	-20 to130 (-4 to 266)	-20 to130 (-4 to 266)	-20 to130 (-4 to 266)	-20 to130 (-4 to 266)
10 ⁷	3.10 ⁷	3.10 ⁷	10 ⁶	10 ⁶	10 ⁶
0.4 (.016)	0.4 (.016)	0.4 (.016)	0.4 (.016)	0.4 (.016)	0.4 (.016)
1.7 (.06)	1.7 (.06)	1.7 (.06)	1.7 (.06)	1.7 (.06)	1.7 (.06)

2

C	C	C	C	C	C
B	B	B	B	B	B
A	A	A	A	A	A

3

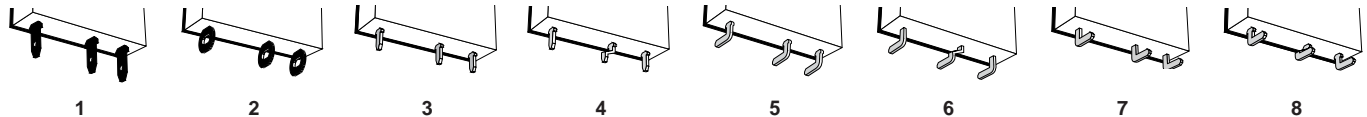

4

A 79 253 327	B 79 253 326	C 79 253 328	E 79 218 454	F 79 253 329
Flat 170A R18.3 (.72)	Flat 170A R24 (.94)	Flat 170A R41 (1.61)	Roller 170E R20 (.79)	Dummy roller 170F R19.5 (.77)
L 3 10.4 ^{+1.2} (.41 ^{+0.05})	L 4 11.1 ^{+1.2} (.44 ^{+0.05})	L 7 13.2 ^{+2.5} (.52 ⁺¹)	L 3 15.4 ^{+1.2} (.61 ^{+0.05})	L 3 13 ^{+1.2} (.51 ^{+0.05})
R 1.5 9.2 ^{+0.6} (.36 ^{+0.24})	R 2 9.6 ^{+0.6} (.38 ^{+0.24})	R 3.5 10.7 ^{+1.2} (.42 ^{+0.05})	R 1.5 14.5 ^{+0.6} (.57 ^{+0.24})	R 1.5 12 ^{+0.6} (.47 ^{+0.24})

D 79 218 491	L 79 218 493
Screw 170D R20 (.79)	Transverse roller 170L R20 (.79)
Characteristics available upon request.	

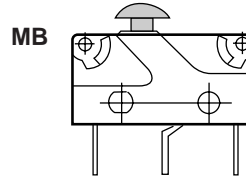

Ø No Actuator

5

To order please specify :

Example : 831700 C 2 • C L

1 Switch Type	2 Contact Type	3 Connection	4 Actuators	5 Actuator Position
831700 831704 831709	A B C	1 5 2 6 3 7 4 8	A B C D Ø E F L MB MB SP4967	L - Left (Standard) R - Right
To order actuators separately, use the 8 digit P/N			Example P/N is 831700 SPDT solder terminals "C" actuator mounted on the left.	

Products and specifications subject to change without notice.

Order/Technical Support – Tel: (800) 677-5311 / FAX: (800) 677-3865 / www.crouzet-usa.com

Subminiature Switches DIN 41635 B

Dimensions

83 170 Asymmetric

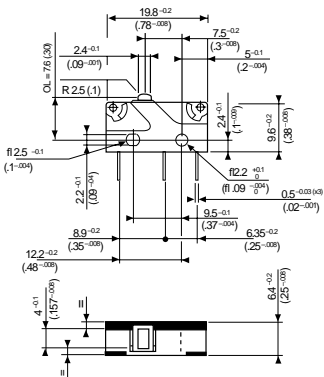

83 170 Symmetric

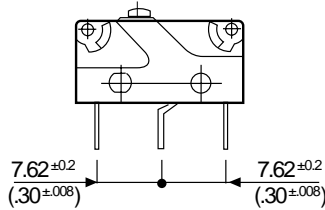

83 170 with MB Button

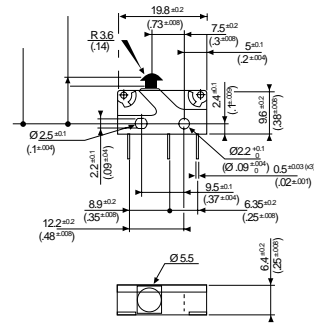

Mounting by M2 screws
Torque : 2 cm daN

mm (in)

Connections

- 2
Solder
- 1
.11x.02 Quick Connects
- 3-4
Straight PCB
- 5-6
Side Output PCB Rear
- 7-8
Side Output PCB Front

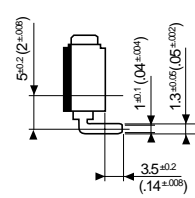
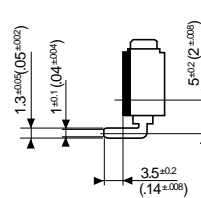
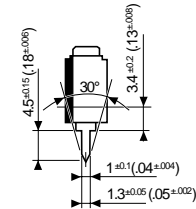
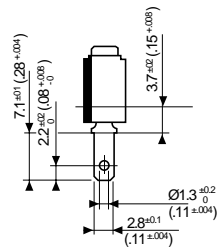
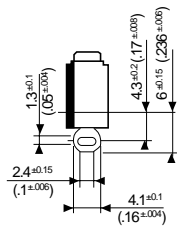

Printed circuit board mounting

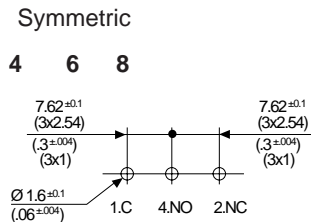
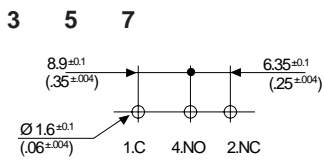

mm (in)

Products and specifications subject to change without notice.

Order/Technical Support – Tel: (800) 677-5311 / FAX: (800) 677-3865 / www.crouzet-usa.com

Actuators

Actuator mounting positions

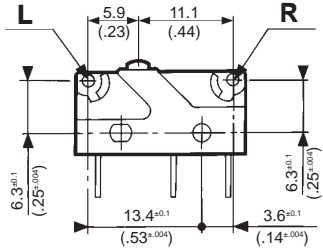

A B C

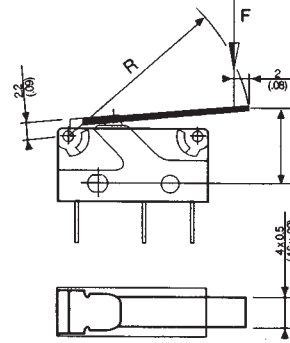

TP (Tripping Point)
Refer to pages 3/6 & 3/7.

E

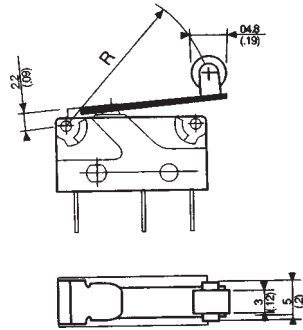

F

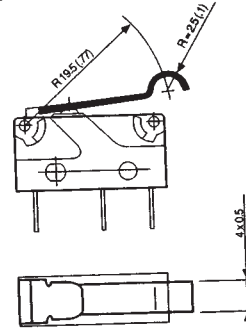

mm (in.)

Mounting accessories

Mounting pins

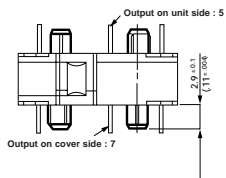

mm (in.)

Products and specifications subject to change without notice.

Order/Technical Support – Tel: (800) 677-5311 / FAX: (800) 677-3865 / www.crouzet-usa.com

General specifications

Layout

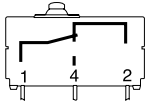

Components

Material

- Case : UL 94VO glass-filled polyester
- Button : Polyester
- Membrane : silicon
- Contacts : AgCdO
AgNi (dual current),
- Terminals : tinned brass
- Cable : PVC (IP 67)
- Leads : PVC

Actuators

- flat : stainless steel
- roller : stainless steel with polyamide roller

Approvals 83 180/83 186 : NF. UL - cUL on request

Operating curve 250 V~

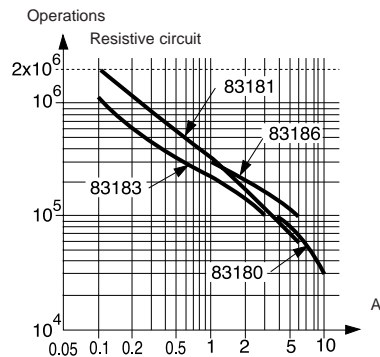

Switch rating with DC supply

		83 180	83 181	83 183	83 186
12 V	Resistive load	10 A	6 A	3 A	6 A
	Inductive L/R 5 ms	10 A	6 A	3 A	6 A
24 V	Resistive load	10 A	6 A	3 A	6 A
	Inductive L/R 5 ms	5 A	5 A	3 A	5 A

Model 83 181 is designed to operate equally well on dual-current (1 mA 4 V minimum) or medium-current (6 A maximum) circuits. However, a given product should only be used to switch one type of circuit during its working life.

Degree of protection

- Tag version : casing = IP67
terminals = IP00
- Lead / cable version : outlet / casing = IP67

Types

Part numbers for standard products with connection of type

1
2
FD0

Features

Electrical characteristics

Current rating at 250 V	Nominal Hp	A
		1/2

Mechanical characteristics

Operating force - max.		N (oz.)
Release force - min.		N (oz.)
Total travel force - max.		N (oz.)
Permitted overtravel force - max.		N (oz.)
Rest position - max.		mm (in.)
Tripping point		mm (in.)
Differential travel		mm (in.)
Overtravel - min.		mm (in.)
Ambient operating temperature	for tag version	°C (°F)
	for lead / cable version	°C (°F)
Mechanical durability		Operations
Contact gap		mm (in.)
Weight (tag version)		g (oz.)

Contact Type

C (Form C) SPDT

B (Form B) SPNC not available in PC terminals

A (Form A) SPNO not available in PC terminals

Connections

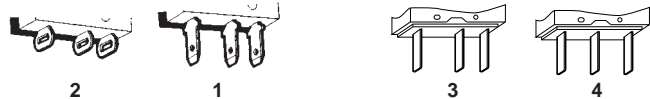

Actuators and mounting positions

Part numbers for standard actuators

Actuators - Length mm (in.)

Mounting position

Coefficient

Tripping point mm (in.)

83 180

83 181/183/186

Part numbers for standard actuators

Actuators - Length mm (in.)

Mounting positions

Coefficient

Tripping point

Except where otherwise indicated, actuators are supplied unmounted.

For factory mounting, specify fixing position L or R.

- **To calculate force** : take the force quoted for the switch and divide by the coefficient given in the table.

- **To calculate travel** : take the travel quoted for the switch and multiply by the same coefficient.

Mounting accessories for PCB mounting : 5 / 6 / 7 / 8

See page 3/9.

Other information

For other forces, actuators, connections and temperatures, please consult us.

Normally stocked items

Catalog products produced to order

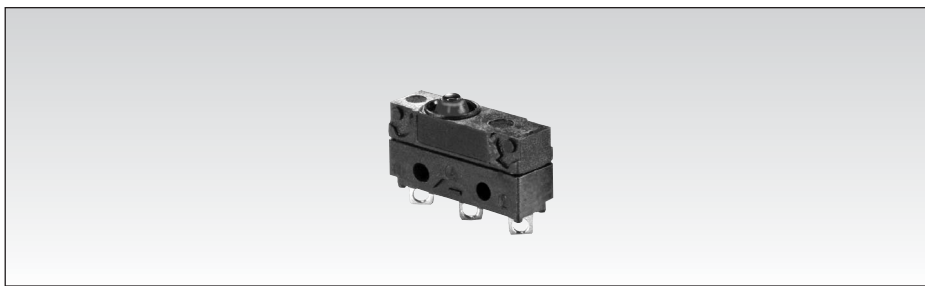

83180	83181	83183	83186
831800C1.0	831810C1.0	831830C1.0	831860C1.0
831800C2.0	831810C2.0	831830C2.0	831860C2.0
831800CFD0.0	831810CFD0.0	831830CFD0.0	831860CFD0.0

High current	Dual current	Medium current	Standard
10 12.5	6 7.5	3 4	6 7.5
3.4 (12) 1 (3.5) 5 (17.6) 10 (35.3) 9.3 (.37) 8.4 ±0.3 (.33 ±0.012) 0.10 (.004) 0.6 (.024) -40 +125 (-40 +257) -40 +105 (-40 +221) 10 ⁶ 0.4 (.016) 2 (.07)	2.5 (8.8) 0.8 (2.8) 4.2 (14.1) 10 (35.3) 9.3 (.37) 8.4 ±0.3 (.33 ±0.012) 0.10 (.004) 0.6 (.024) -40 +125 (-40 +257) -40 +105 (-40 +221) 2 x 10 ⁶ 0.4 (.016) 2 (.07)	2.5 (8.8) 0.8 (2.8) 4.2 (14.1) 10 (35.3) 9.3 (.37) 8.4 ±0.3 (.33 ±0.012) 0.10 (.004) 0.6 (.024) -40 +125 (-40 +257) -40 +105 (-40 +221) 2 x 10 ⁶ 0.4 (.016) 2 (.07)	2.5 (8.8) 0.8 (2.8) 4.2 (14.1) 10 (35.3) 9.3 (.37) 8.4 ±0.3 (.33 ±0.012) 0.10 (.004) 0.6 (.024) -40 +125 (-40 +257) -40 +105 (-40 +221) 2 x 10 ⁶ 0.4 (.016) 2 (.07)

C	C	C	C
B	B	B	B
A	A	A	A

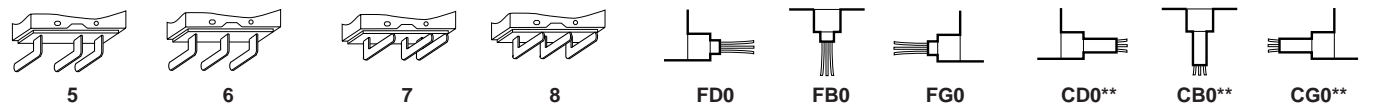

A 79 253 327	B 79 253 326	C 79 253 328	E 79 218 454
Flat 170A R18.3 (.72)	Flat 170A R24 (.94)	Flat 170A R41 (1.61)	Roller 170E R20 (.79)
L _____ R _____ 3 _____ 1.5 _____ 10.4 ^{+1.2} (.41 ^{+0.05}) 9.2 ^{+0.6} (.36 ^{+0.24})	L _____ R _____ 4 _____ 2 _____ 11.1 ^{+1.2} (.44 ^{+0.05}) 9.6 ^{+0.6} (.38 ^{+0.24})	L _____ R _____ 7 _____ 3.5 _____ 13.2 ^{+2.5} (.52 ⁺¹) 10.7 ^{+1.2} (.42 ^{+0.05})	L _____ R _____ 3 _____ 1.5 _____ 15.4 ^{+1.2} (.61 ^{+0.05}) 14.5 ^{+0.6} (.57 ^{+0.24})

F 79 253 329	D *	L *
Dummy roller 170F R19.5 (.77)	Screw 170D	Transverse roller 170EL *
L _____ R _____ 3 _____ 1.5 _____ 13 ^{+1.2} (.51 ^{+0.05}) 12 ^{+0.6} (.47 ^{+0.24})		

Ø No Actuator

* Special order, contact us for part number
** Cable version for types 83 181, 83 183 and 83 186

To order please specify :

1 Switch Type 831810 831830 831860 831800	2 Contact Type A B C	3 Connection 1 6 2 7 3 8 4 FDØ CDØ 5 FGØ CBØ FBØ CGØ	4 Actuators Ø F L A B C D E	5 Actuator Position L - Left (Standard) R - Right
--	--------------------------------------	---	--	--

To order actuators separately, use the 8 digit P/N

Example P/N is 831810 SPDT solder terminals with no actuator.

Products and specifications subject to change without notice.

Order/Technical Support – Tel: (800) 677-5311 / FAX: (800) 677-3865 / www.crouzet-usa.com



Sealed Subminiature Switches DIN 41635 B

Dimensions

Symmetric

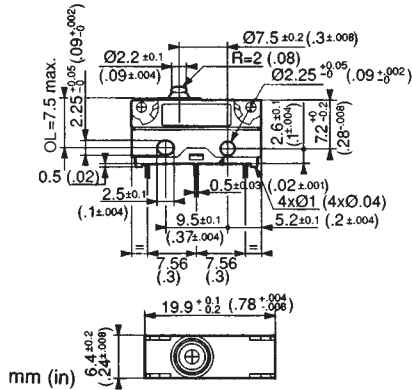

Asymmetric

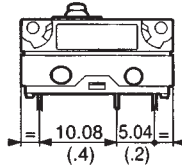

Fixed by 2 x M2 screws
Torque for screw alone: 0.2 Nm (1.75 in. lbs.)
screw + washer: 0.3 Nm (2.65 in. lbs.)

Connections

Terminals

2 Solder

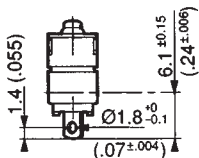

1 Faston 2.8 x 0.5
.110" Quick Connects

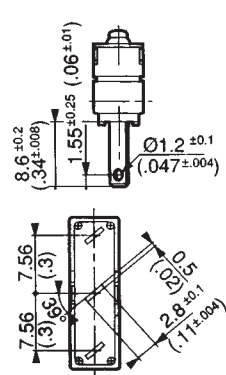

3 - 4 Straight PCB output

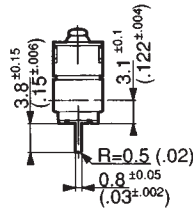

5 - 6 Side output,
PCB rear

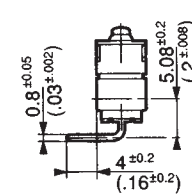

7 - 8 Side output,
PCB front

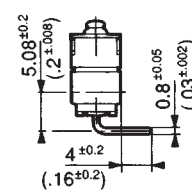

Printed circuit board mounting

Asymmetric
3, 5, 7

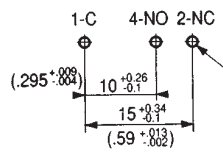

Symmetric
4, 6, 8

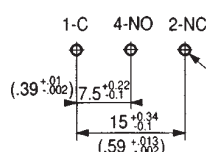

Mounting on a printed circuit board with mounting pins

Asymmetric

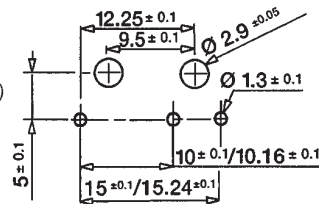

Symmetric

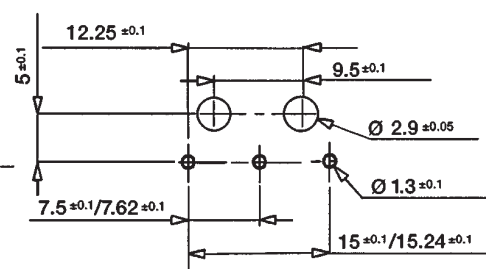

Lead output

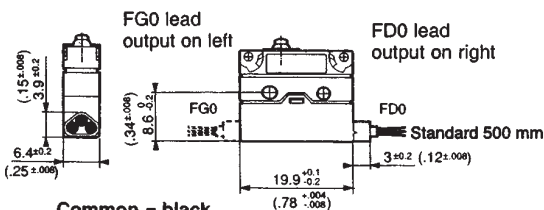

Common = black
NC = brown
NO = blue
mm (in)

Conductor cross-section :
83181 / 83183 / 83186 = $3 \times 0.5 \text{ mm}^2$ (.12 \times .02 in²)
83180 = $3 \times 0.75 \text{ mm}^2$ (.12 \times .03 in²)

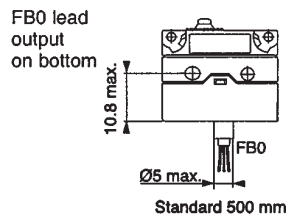

Mounting pins

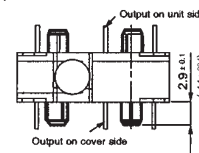

Products and specifications subject to change without notice.

Order/Technical Support – Tel: (800) 677-5311 / FAX: (800) 677-3865 / www.crouzet-usa.com

Cable output

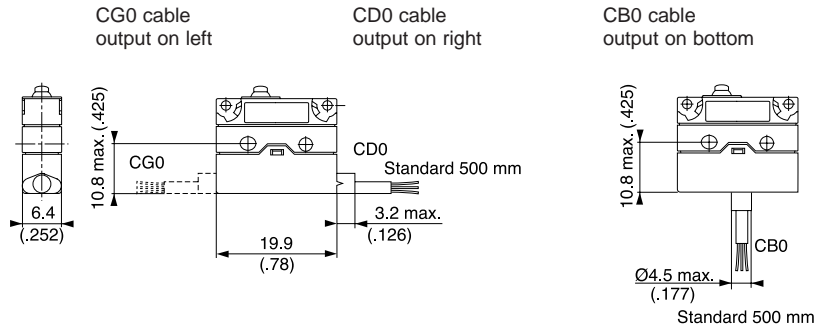

Conductor cross-section :
 83181 / 83183 / 83186 = 3 x 0.5 mm²
 (.12 x .02 in²)

Common = black
 NC = brown
 NO = blue

mm (in.)

Actuators

Mounting positions

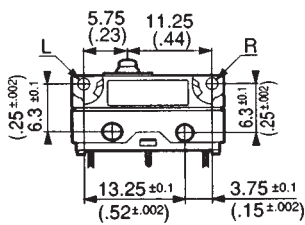

A, B, C
Flat

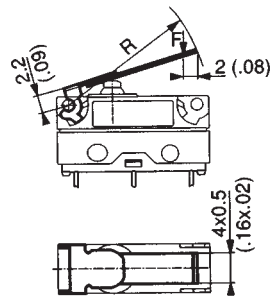

E
Roller

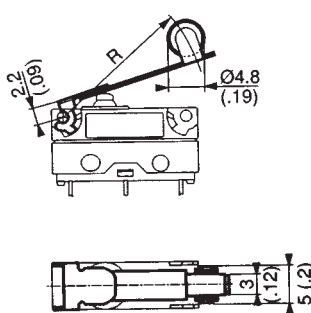

F
Dummy roller

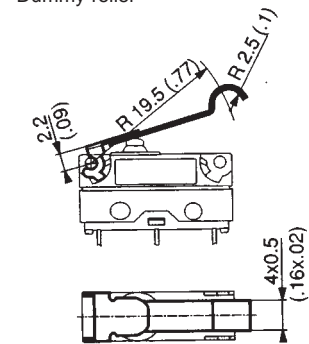

mm (in.)

Recommendations for operation from the side



Products and specifications subject to change without notice.

Order/Technical Support – Tel: (800) 677-5311 / FAX: (800) 677-3865 / www.crouzet-usa.com

General specifications

Layout

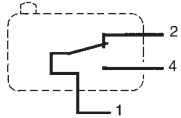

Components

Material

- Case : glass-filled polyamide (self-extinguishing version to UL 94 VO and IEC 695-2-1 850° C - available on request)
- Button : polyamide
- Contacts : nickel silver or gold alloy (dual-current)

Actuators

- flat : stainless steel
- roller : stainless steel, glass-filled polyamide roller
- other types of polyamide

Approvals: NF - UL/cUL

Operating curve

For type 83 161 1 3

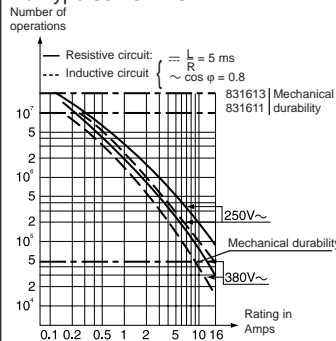

For type 83 161 5 - 5 SP 4136

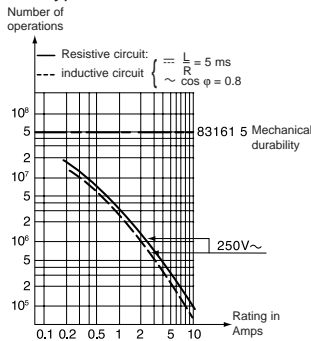

For type 83 161 8

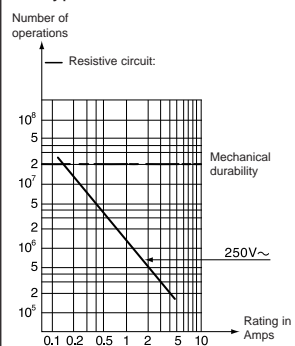

For type 83 161 9 SP 4136

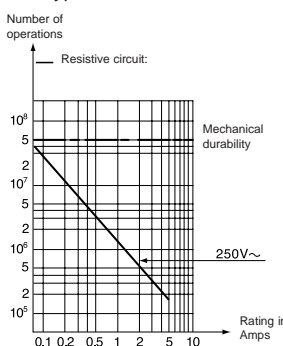

For types 83 161 8 - 9 SP 4136 dual-current

Models 83 161 8 and 83 161 9 SP 4136 are designed to operate equally well on dual-current (1 mA 4 V minimum) or medium-current (5 A maximum) circuits. However, a given product should only be used to switch one type of circuit during its working life.

Types

Part numbers for standard products with connections of type

2
3
6

Features

Electrical characteristics

Current rating at 125/250 V	Current	A
	Horsepower	HP

Mechanical characteristics

Operating force - max.	N (oz.)
Release force - min.	N (oz.)
Total travel force - max.	N (oz.)
Permitted overtravel force - max.	N (oz.)
Rest position - max.	mm (in.)
Tripping point	mm (in.)
Differential travel	mm (in.)
Overtravel - min. (OT)	mm (in.)
Ambient operating temperature	°C (°F)
Mechanical durability (for 2/3 OT)	Operations
Contact gap	mm (in.)
Weight	g (oz.)

Contact type

C (Form C) SPDT

B (Form B) SPNC

A (Form A) SPNO

Connections



2 solder



3 for 1/4" Quick Connects

Actuators and mounting positions

Part numbers for standard actuators **A** 79 215 740

Actuators-Length mm (in.) Flat **161A** R14.2 (.56)



Mounting positions	A	B
Coefficient	2	1
Tripping point (except 83 161 6)	15.2 $\pm 1(.6 \pm 0.004)$	15.2 $\pm 0.45(.6 \pm 0.018)$
Tripping point 83 161 6	14.8 $\pm 1(.59 \pm 0.004)$	15 $\pm 0.45(.59 \pm 0.018)$

Part numbers for standard actuators **H** 79 218 651

Actuators-Length mm (in.) Dummy roller **161G** R21.8 (.86)



Mounting positions	A	B
Coefficient	3	1.8
Tripping point (except 83 161 6)	21.7 $\pm 2(.85 \pm 0.08)$	21.7 $\pm 0.7(.85 \pm 0.03)$
Tripping point 83 161 6	21.5 $\pm 2(.85 \pm 0.08)$	21.5 $\pm 0.7(.85 \pm 0.03)$

Other information

For other forces, actuators, connections and temperatures, please consult us.

Normally stocked items

Catalog products produced to order

Products and specifications subject to change without notice.

Order/Technical Support – Tel: (800) 677-5311 / FAX: (800) 677-3865 / www.crouzet-usa.com

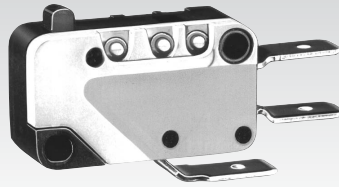

83161.1(10.1A)	83161.2(15.1A)	83161.3(10.1A)	83161.5(4A) 83161.9(0.1A)	83161.5SP4136 83161.9SP4136	83161.6	83161.8(0.1A)
831611C2.0 831611C3.0 831611C6.0	831612C2.0 831612C3.0 831612C6.0	831613C2.0 831613C3.0 831613C6.0	831615C2.0 831615C3.0 831615C6.0	• • •	831616C2.0 831616C3.0 831616C6.0	831618C2.0 831618C3.0 831618C6.0
High Force	High Current	Standard	Low Force	Ultra Light Force	Wide Gap	Dual Current

10.1 1/2	15.1 1/2	10.1 1/2	4 1/10	4 1/10	6.1 1/3	0.1 N/A
3 (10.5) 1 (3.5) 4.5 (15.8) 20 (70.5) 16.1 (0.63) 14.7 ^{±0.4} (.58 ^{±0.16}) 0.35 (0.014) 1.1 (0.05) -20 +125 (-4 +257) 10 ⁷ 0.4 (0.016) 5.6 (.2)	0.8 (2.8) 0.2 (0.7) 2 (7.0) 20 (70.5) 16.2 (0.64) 14.7 ^{±0.3} (.58 ^{±0.16}) 0.35 (0.014) 1.2 (0.05) -20 +125 (-4 +257) 2 x 10 ⁷ 0.4 (0.016) 5.6 (.2)	0.8 (2.8) 0.2 (0.7) 2 (7.0) 20 (70.5) 16.2 (0.64) 14.7 ^{±0.3} (.58 ^{±0.16}) 0.35 (0.014) 1.2 (0.05) -20 +125 (-4 +257) 2 x 10 ⁷ 0.4 (0.016) 5.6 (.2)	0.25 (0.9) 0.05 (0.18) 0.35 (1.2) 20 (70.5) 16.3 (0.64) 14.7 ^{±0.4} (.58 ^{±0.16}) 0.35 (0.014) 1.1 (0.05) -20 +125 (-4 +257) 5 x 10 ⁷ 0.4 (0.016) 5.6 (.2)	0.15 (0.54) 0.04 (0.14) 0.2 (0.72) 20 (70.5) 16.3 (0.64) 14.7 ^{±0.3} (.58 ^{±0.16}) 0.35 (0.014) 1.2 (0.05) -20 +125 (-4 +257) 5 x 10 ⁷ 0.4 (0.016) 5.6 (.2)	5 (18) 0.5 (1.8) 6 (21.6) 20 (70.5) 16.1 (0.63) 14.5 ^{±0.4} (.58 ^{±0.16}) 0.8 (0.03) 0.9 (0.035) -20 +125 (-4 +257) 5 x 10 ⁴ 3.2 (0.126) 5.6 (.2)	0.8 (2.8) 0.2 (0.7) 0.2 (.07) 20 (70.5) 16.2 (0.64) 14.7 ^{±0.4} (.58 ^{±0.16}) 0.35 (0.014) 1.2 (0.05) -20 +125 (-4 +257) 2 x 10 ⁷ 0.4 (0.016) 5.6 (.2)

C B A	C B A	C B A	C B A	C B A	C B A	C B A
-------------	-------------	-------------	-------------	-------------	-------------	-------------

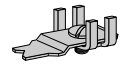

5 screw



6 for 3/16 Quick Connects



7 for .11 Quick Connects

B 70 507 524	E 79 215 742	G 70 507 529	F 70 507 528
Flat 161A R25.4 (1)	Roller 161E R13.6 (.54)	Roller 161E R24.1 (.95)	Dummy 161F roller R22.2 (.84)
A 4 15.2 ^{±2.5} (.6 ^{±1}) 14.4 ^{±2.5} (.56 ^{±1})	A 2 20.5 ^{±1.5} (.81 ^{±0.06}) 20.1 ^{±1.5} (.79 ^{±0.06})	B 1 20.5 ^{±0.8} (.81 ^{±0.03}) 20.3 ^{±0.8} (.80 ^{±0.03})	C 1.5 20.5 ^{±1.2} (.81 ^{±0.05}) 20.2 ^{±1.2} (.79 ^{±0.05})
B 2 15.2 ^{±1} (.6 ^{±0.04}) 14.8 ^{±1} (.58 ^{±0.04})	C 1.5 15.2 ^{±0.8} (.6 ^{±0.03}) 14.9 ^{±0.8} (.59 ^{±0.03})	A 2 20.5 ^{±1.5} (.81 ^{±0.06}) 20.1 ^{±1.5} (.79 ^{±0.06})	B 1.8 20.4 ^{±2} (.8 ^{±0.08}) 20.2 ^{±2} (.79 ^{±0.08})

L	V 161V	C 70 507 526	D 79 215 835
** Telescopic plunger Manual action 161L	161V	Flat 161A R50 (1.9)	Flat 161A R60 (2.39)
D Factory Mount only 1 21.5 ^{±1} (.85 ^{±0.04}) 21.5 ^{±1} (.85 ^{±0.04})	D Factory Mount only 1 18.35 ^{±0.45}	A 6 15.2 ^{±0.3} B 3 15.2 ^{±2} C 2 15.2 ^{±1.5}	A 7 15.2 ^{±0.9} B 3.5 15.2 ^{±2.5} C 2.2 15.2 ^{±2.3}

For factory mounting, specify fixing position A, B or C

** For 83 161 1, 83 161 3, 83 161 6, 83 161 8, mounted in factory (supplied without nut)

To order, please specify :

1 Switch Type 831612 831619 831613 831616 831615 831611 831618	2 Contact Type A B C	3 Connection 2 3 5 6 7	Example : 831612 C 3 • C A	4 Actuators Ø A B C D E	5 Actuator Position F G H L V Ø = No actuator
---	--------------------------------------	--	----------------------------	--	--

To order actuators separately, use the 8 digit P/N

Example switch is 831612, SPDT, 1/4" Q.C., C actuator mounted in A position

Miniature Switches DIN 41635 A

Dimensions

83 161

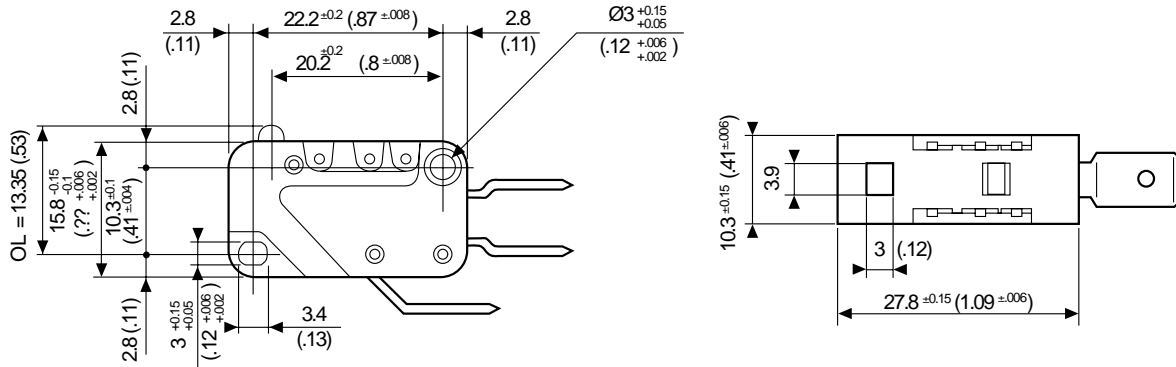

mm (in)

Connections

2 Solder

3 (6.3x0.8 (1/4x.03)) Quick Connects

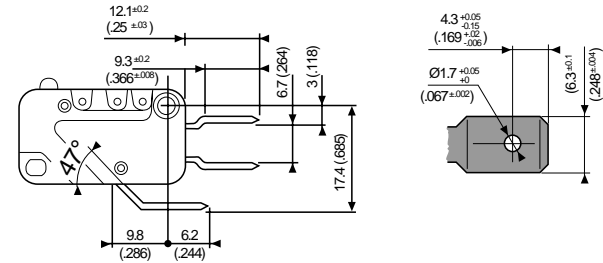
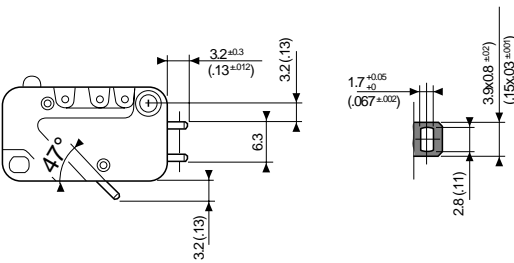

5 Screw

6 (4.8x0.5 (.3/16x.02)) Quick Connects

7 (2.5x0.5 (.11x.02)) Quick Connects

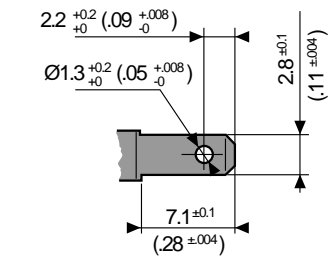
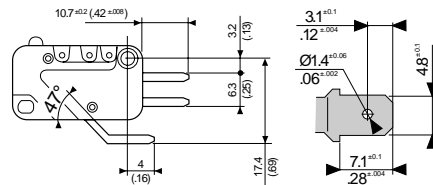
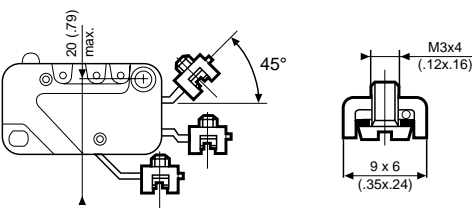

Actuators

mm (in)

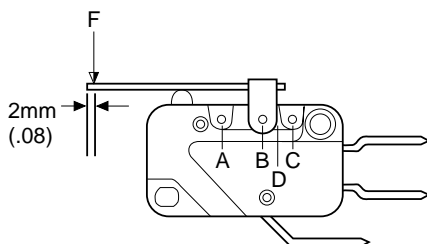

Force calculation : divide the switch forces by the coefficient in the table.

Travel calculation : multiply the switch travel by the same coefficient.

Example :

83 161 3 with B Flat 161A actuator R 25.4 (1) position A (coef. 4)

Operating force : $0.8 \div 4 = 0.2 \text{ N}$

Pre-travel: $1.4 \times 4 = 5.6 \text{ mm}$ ($.055 \times 4 = .22 \text{ in}$)

Products and specifications subject to change without notice.

Order/Technical Support – Tel: (800) 677-5311 / FAX: (800) 677-3865 / www.crouzet-usa.com

Actuator Mounting Positions

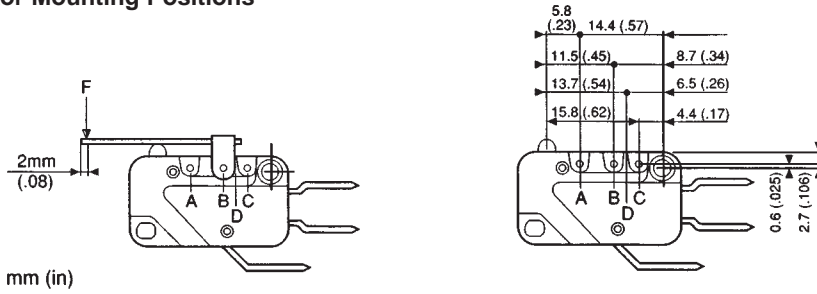

Actuators

E - G

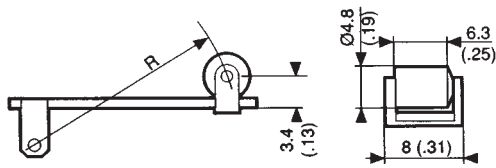

A - B - C - D

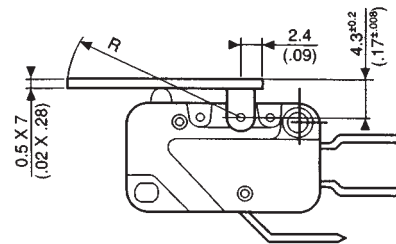

L

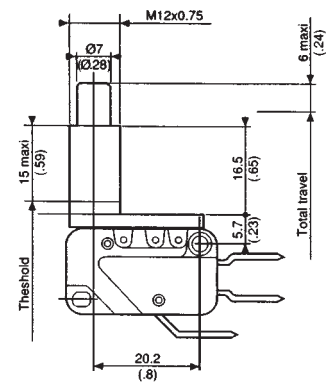

V

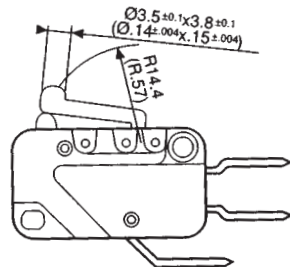

F

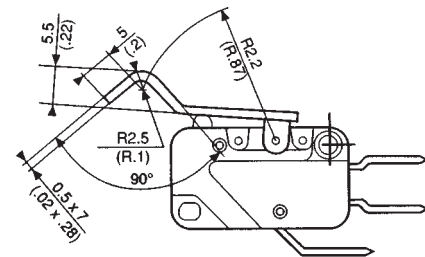

mm (in)

H

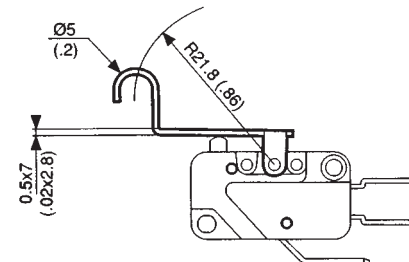

Nut depth	Torque max.
1.5mm (.06)	5Cm N (7 in. oz.)
2mm (.08)	7Cm N (10 in. oz)
2.5mm (.1)	10Cm N (14 in. oz)

Accessories

Nuts 70 602 118 for L type actuator

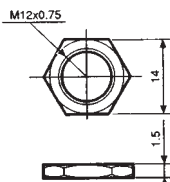

Products and specifications subject to change without notice.

Order/Technical Support – Tel: (800) 677-5311 / FAX: (800) 677-3865 / www.crouzet-usa.com



Miniature Positive Break Switches Series 83 160 DIN 41635 A

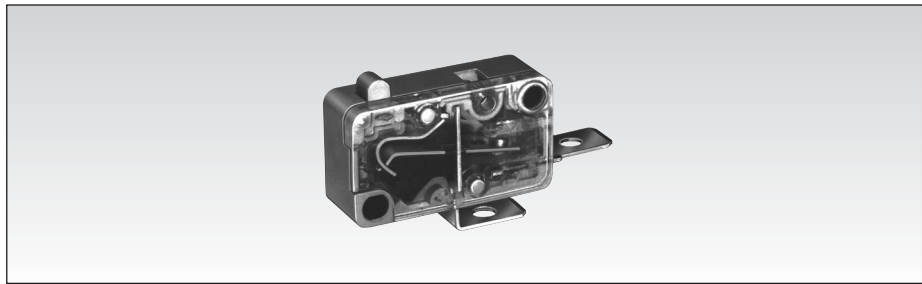

General specifications

Layout

The contact conforms to NFC 63 143 and IEC 947.5.1

*The SPDT version conforms to standard IEC 947.5.1 if only the normally closed contact is used.

The switch operating principle forces the contacts open even in the event of welding (positive break operation).

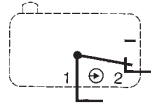

Components

Material

- Case : glass-filled polyamide
- Cover : transparent polycarbonate
- Contacts : nickel silver
- Positive rocker : high temperature thermoplastic
- Actuators** : stainless steel
- polyamide roller

Electrical characteristics

Short-circuit test

- (from IEC 947-5-1 § 8.34)
- Current peak 1000 A at 250 V ~ 0.5 <math>\cos \varphi < 0.7</math>
- Short-circuit protection (SCPD) : fuse 10 A gG (IEC 60) (1.2/50 μ s) : 2500 V

Electrical life

- Max. operations : 20 cycles/min
- Resistive load at 250 V ~ 16 A : 10^5 cycles
- Inductive load (IEC 947.5.1) : AC 15 : 250 V ~ 6A : 0.3×10^5 operations
- DC 13 : 24 V ~ 20 W L/R = 40 ms : 3×10^5 operations
- 120 V ~ 20 W L/R = 40 ms : 5×10^5 operations

Definitions

P.O.F. Minimum Positive Opening Force. The operating force that has to be applied to the operating device to produce the positive opening action.

P.O.P. Maximum Positive Opening Position. The position of the operating device at the moment when positive opening of the contacts occurs.

For other definitions, see "Basic concepts".

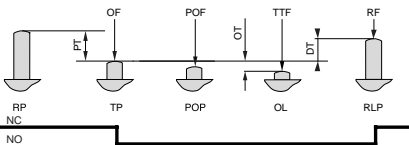

Types

83 160 7

Features	With positive break operation	
	NC	SPDT*
Electrical characteristics		
Assigned working voltage (Ue)	V	250
Assigned working current (Ie)	A	6
Thermal current rating (Ith)	A	10
Assigned circuit voltage (Ui)	V	250
Mechanical characteristics		
Operating force - max.	N (oz.)	4 (14.1)
Release force - min.	N (oz.)	1.5 (3.5)
Min. positive opening force	N(oz.)	18 (63.5)
Permitted overtravel force - max.	N (oz.)	200 (70.5)
Maximum rest position	mm (in.)	15.7 (.62)
Tripping point	mm (in.)	14.8 ^{+0.3} (.58 ^{+0.012})
Maximum positive opening position	mm (in.)	13.5 (.53)
Overtravel - min.	mm (in.)	1.3 (0.047)
Operating speed max.	m/s (ft/sec)	0.5 (1.64)
Operating rate max.	(operation/s)	5
Operating temperature	°C (°F)	-40+85 (-40+185)
Mechanical durability	Operations	10 ⁷
Contact gap	mm (in.)	1.2 (0.05)
Weight	g (oz.)	7 (0.25)

Contact Type

B (NC)

B

C (SPDT)*

C

Connections



2 solder

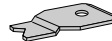

3 for 1/4" Quick Connects



6 for 3/16" Quick Connects



X1 for printed circuit board

Actuators and mounting positions

Dimensions

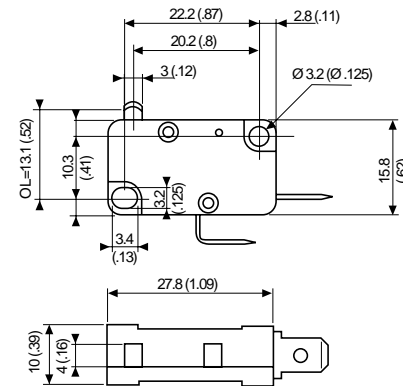

mm (in)

Actuators**

Ø=no Actuator

A (Flat)

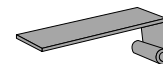

E (Roller)

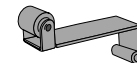

L (Pushbutton)

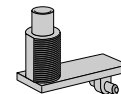

Other information

For other accessories, connections : please consult us

*NO – contact is not positive break

** Consult us for actuator length, forces and positions

To order, specify :

Example : 831607 B 3 • Ø

1 Switch Type	2 Contact Type	3 Connection	4 Actuator Type
831607	B C	2 3 6 X1	A L E Ø = No Actuator

Products and specifications subject to change without notice.

Order/Technical Support – Tel: (800) 677-5311 / FAX: (800) 677-3865 / www.crouzet-usa.com

Miniature Side Rotary (High Sensitivity) Switches Series 83 137



General specifications Layout



Components

Material

- Case : glass filled polyamide

- Contacts : silver

Actuators

- Stainless steel wire

Operating curve

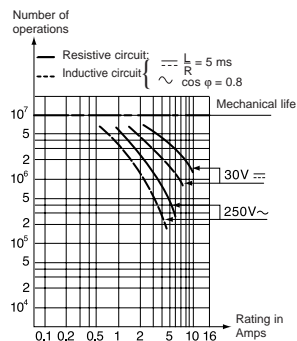

Actuator setting in α

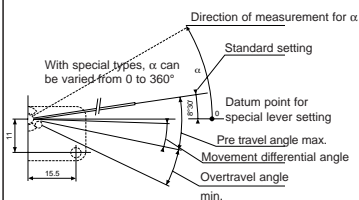

Approvals CSA (LR-20418), ASE, Semko, UTE & VDE.

For other connections, actuators, approvals accessories... Please consult factory

Types

83 137 0

Features

Standard

Electrical characteristics

Current rating at 125-250 V	Nominal	A	5
	Thermal	A	14

Mechanical characteristics

Maximum operating force	N cm (in. oz)	0.12 (.17)
Minimum release torque	N cm (in. oz)	0.03 (.042)
Overtravel torque	N cm (in. oz)	0.5 (.71)
Movement differential	°	10 ^{+0.4}
Overtravel - min.	°	12
Operating temperature	°C (F°)	-20 to 125 (-4 to 257)
Mechanical life	Operations	10 ⁷
Contact gap	mm (in)	0.8 (.031)
Weight	g (oz)	7.2 (.25)

Contact Type

C (Form C) SPDT

B (Form B) SPNC

A (Form A) SPNO

C

B

A

Connections



2 solder

3 for 1/4" Quick Connects

Dimensions

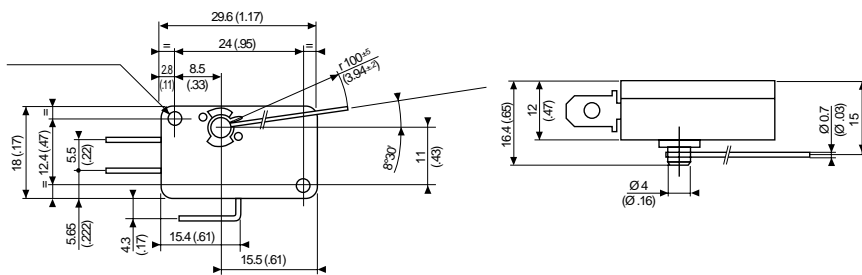

mm (in)

Dimensions connections

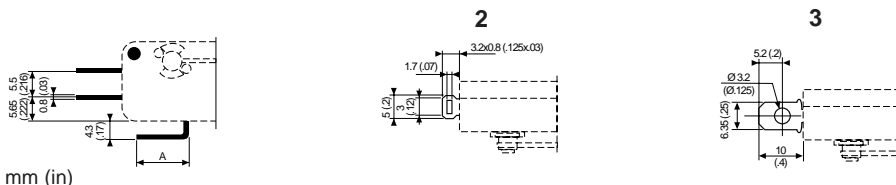

mm (in)

To order, please specify :

Example : 831370 C 3 . W

1 Switch Type

831370

2 Contact Type

A
B
C

3 Connection

2
3

Example switch is: 831370, SPDT, 1/4" Q.C.

Products and specifications subject to change without notice.

Order/Technical Support – Tel: (800) 677-5311 / FAX: (800) 677-3865 / www.crouzet-usa.com

Standard Switches (Double Break) Series 83 106 / 83 109 / 83 112 / 83 154

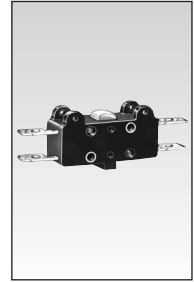

General specifications

Layout



- The NO and NC circuits must both be of the same polarity.

Components

Material

- Case : polyamide (83 106 to 83 112)
- Case : Diallyl-Phthalate (83 154)
- Contacts : nickel silver

Actuators

- passivated mild steel
 - roller : nylon
 - adjustable screws : self-retaining
 - plates : passivated mild steel (zinc)
- Note : Fixing holes for these switches have metal ferrules.

Approvals: UL - cUL

Operating curve

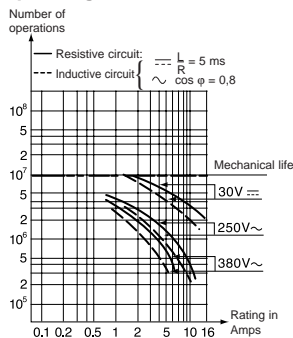

83 154

Types

83 106 0

Features

Standard

Electrical characteristics

Current rating at 250 V	Nominal ---	A	—
	Nominal ~		10
	Thermal	A	17.5

Mechanical characteristics

Operating force - max.	N (oz.)	4 (14.1)
Release force - min.	N (oz.)	1 (3.5)
Permitted overtravel force - max.	N (oz.)	20 (70.5)
Maximum rest position	mm (in.)	12.75 (.5)
Tripping point	mm (in.)	11.45 ^{+0.2 -0.25} (11.45 ^{+0.2 -0.25})
Differential travel	mm (in.)	0.5 ^{±0.2} (0.02 ^{±0.008})
Overtravel - min.	mm (in.)	0.7 (.28)
Ambient operating temperature	°C (°C)	-20 +85 (-4 +185)
Mechanical durability	Operations	10 ⁷
Contact gap	mm (in.)	0.4 x 2
Weight	g (oz.)	8

Contact type

C (Form C) SPDT

C

B (Form B) SPNC

A (Form A) SPNO

Connections

Actuators and mounting positions

Part numbers for standard actuators

A 70 500 888

Actuators-Length mm (in.) Flat R49 (1.92)



Operating force - max.	N (oz.)	1.2 (4.2)
Release force - min.	N (oz.)	0.25 (.9)
Pre-travel - max.	mm (in.)	6.2 (.24)
Differential travel	mm (in.)	2.1 ^{±0.9} (.083 ^{±0.36})
Total travel max.	mm (in.)	7.5 (.3)

Except where otherwise indicated, the flat and roller actuators are mounted as shown in the dimensional drawings (mounted on the left).

Assemblies

Other information

For other forces, actuators, connections and temperatures, please consult us.

Normally stocked items

Catalog products produced to order

Products and specifications subject to change without notice.

Order/Technical Support – Tel: (800) 677-5311 / FAX: (800) 677-3865 / www.crouzet-usa.com

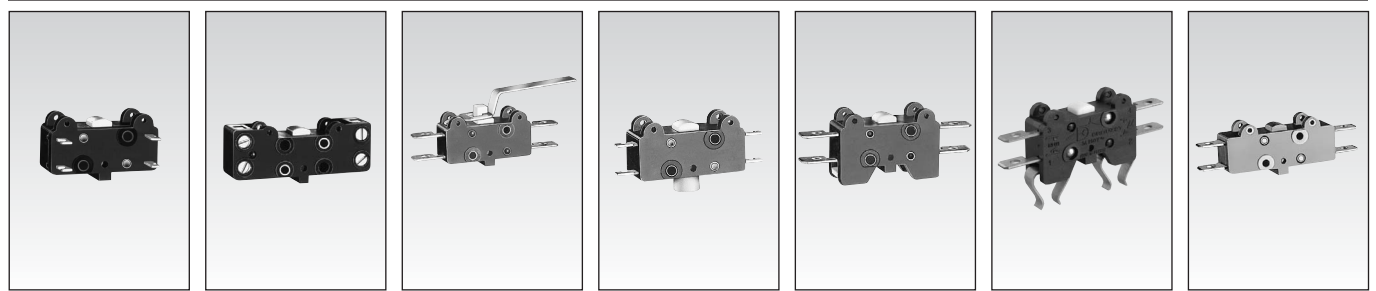

83 109 0	83 112 0	83 106 4	83 106 7	83 111 0	83 111 5	83 154 0
-----------------	-----------------	-----------------	-----------------	-----------------	-----------------	-----------------

Face terminals	Enclosed screws	Bistable, 2 actuator positions	Bistable, 2 push button positions	Base mounting by screws	Base mounting by clips	Magnetic blow-out switch
—	—	—	—	—	—	5
10	10	10	10	10	10	—
17.5	17.5	17.5	17.5	17.5	17.5	17.5
4 (14.1)	4 (14.1)	0.45 (1.62)	2 (7.19)	4 (14.1)	4 (14.1)	4 (14.1)
1 (3.5)	1 (3.5)			1 (3.5)	1 (3.5)	1 (3.5)
20 (70.5)	20 (70.5)			20 (70.5)	20 (70.5)	20 (70.5)
12.75 (.5)	12.75 (.5)					
11.45 ^{+0.2 -0.25} (.45 ^{+0.008})	11.45 ^{+0.2 -0.25} (.45 ^{+0.008})			11.45 ^{+0.2 -0.25} (.45 ^{+0.008})	11.45 ^{+0.2 -0.25} (.45 ^{+0.008})	11.45 ^{+0.2 -0.25} (.45 ^{+0.008})
0.5 ^{±0.2} (.02 ^{±0.008})	0.5 ^{±0.2} (.02 ^{±0.008})			0.5 ^{±0.2} (.02 ^{±0.008})	0.5 ^{±0.2} (.02 ^{±0.008})	0.65 ^{±0.25} (.02 ^{±0.008})
0.7 (.29)	0.7 (.29)			0.7 (.29)	0.7 (.29)	0.7 (.29)
-20 +85 (-4 +185)	-20 +85 (-4 +185)	-20 +85 (-4 +185)	-20 +85 (-4 +185)	-20 +85 (-4 +185)	-20 +85 (-4 +185)	-40 +125 (-4 +257)
10 ⁷	10 ⁷	10 ⁶	10 ⁶	10 ⁷	10 ⁷	10 ⁷
0.4 x 2 (.016 x .08)	0.4 x 2 (.016 x .08)	0.4 x 2 (.016 x .08)	0.4 x 2 (.016 x .08)	0.4 x 2 (.016 x .08)	0.4 x 2 (.016 x .08)	0.5 x 2 (.016 x .08)
8 (.3)	14.5 (.3)	9 (.32)	8 (.3)	8 (.3)	8 (.3)	11 (.3)

Contact type						
C	C	C	C	C	C	C
		B	B	B	B	B
		A	A	A	A	A

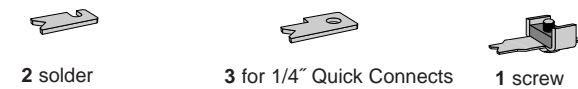

B 70 500 828	E 70 500 813	Q 70 500 840	T 70 500 870	B9	21 416 364
R49 (1.92)	Flat R47 (1.85)	Lever R26 (1.02)	R15.5 (.61)	Operation B9	Plate Mounting Screw
1.2 (4.2)	1.2 (4.2)	2.8 (9.9)	4 (14.1)	4 (14.1)	
0.25 (.9)	0.25 (.9)	0.45 (1.6)	0.8 (2.8)	1 (3.5)	
6.2 (.24)	6.2 (.24)	3.2 (.125)	1.45 (.057)	1.5 (.059)	
2.1 ^{±0.9} (.083 ^{±0.035})	2.1 ^{±0.9} (.083 ^{±0.035})	1.05 ^{±0.4} (.041 ^{±0.016})	0.5 ^{±0.2} (.02 ^{±0.008})	0.5 ^{±0.2} (.02 ^{±0.008})	
8.4 (.33)	7.5 (.31)	4.5 (.18)	1.9 (.075)	1.9 (.075)	

Y 70 500 206	H 70 500 208	O2 70 500 218	K2 2-pole vertical mounting plate
Y Side plate	H Horizontal single-pole mounting plate	O2 2-pole side mounting plate	

To order, specify :				
1 Switch Type	2 Contact Type	3 Connection	Example : 831810 C 2 • Ø	4 Actuators
831060	C	1		A
831090	B	2		T
831120	A	3		B9
831540			To order actuators separately, use the 8 digit P/N	Ø = No actuator
				E
				Q
				5 Actuator Position
				L - Left (Standard)
				R - Right

Products and specifications subject to change without notice.

Order/Technical Support – Tel: (800) 677-5311 / FAX: (800) 677-3865 / www.crouzet-usa.com

Standard Switches

Dimensions

83 106 - 83 109 - 83 154

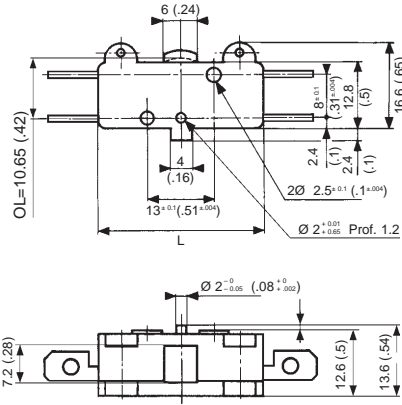

83 106 4

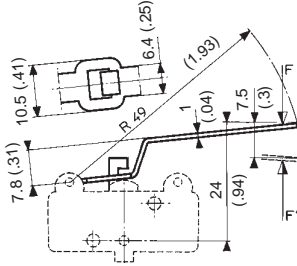

83 106 7

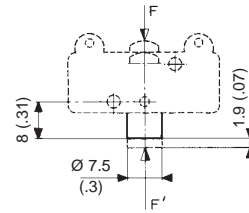

Products	L
83 106 / 109 / 111	32 (1.26)
83 154	40 (1.57)

83 111 0

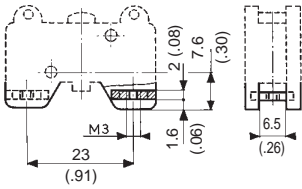

83 111 5

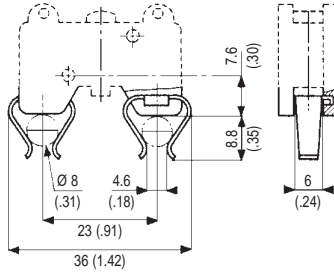

83 112

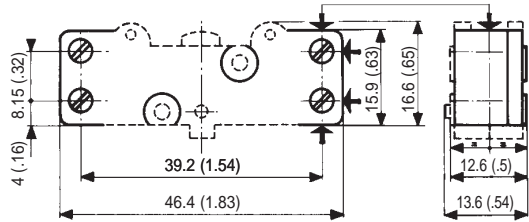

mm (in)

Connections

1

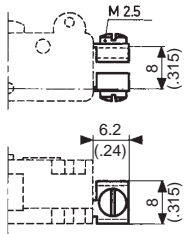

2 (83 106)

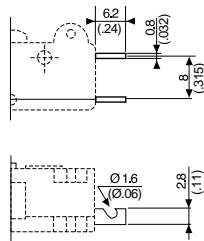

2 (83 109)

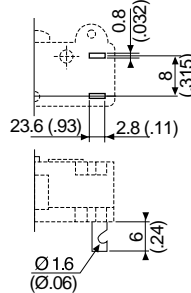

3

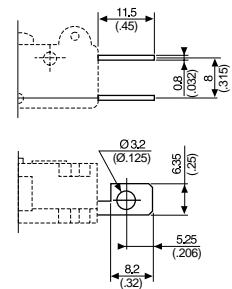

mm (in)

Products and specifications subject to change without notice.

Order/Technical Support – Tel: (800) 677-5311 / FAX: (800) 677-3865 / www.crouzet-usa.com

Actuators

Cross-section of actuators 1 x 6.4 mm (.039 x .252 in.)

A

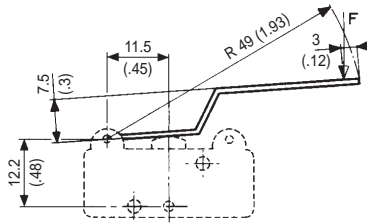

B

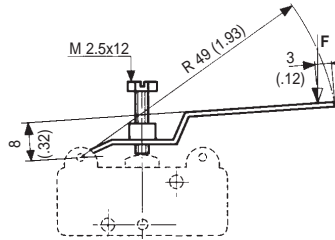

E

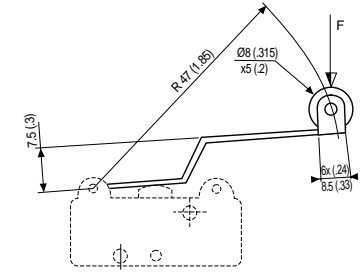

Q

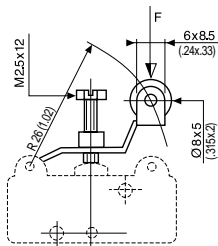

B9

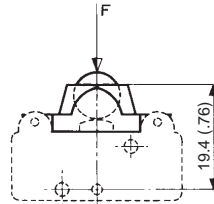

T

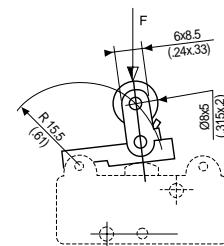

mm (in.)

Assemblies

Y

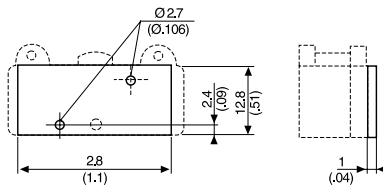

O2

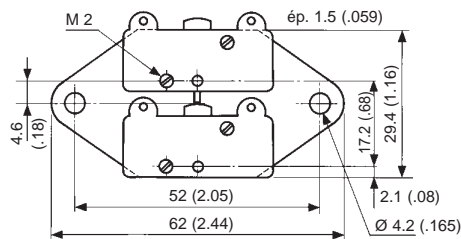

K2

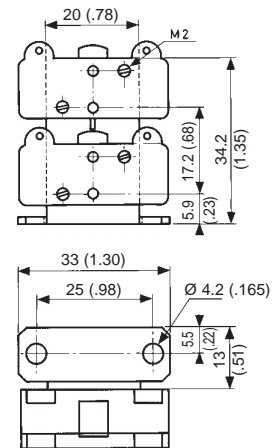

H

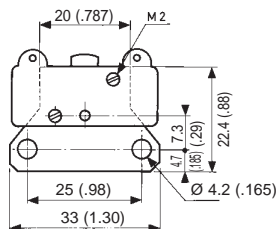

Unless indicated, the thickness of plates is 1.5 mm (.059 in.)

mm (in.)

Products and specifications subject to change without notice.

Order/Technical Support – Tel: (800) 677-5311 / FAX: (800) 677-3865 / www.crouzet-usa.com

General specifications

Layout

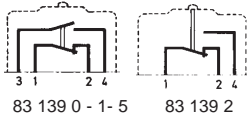

Components

Material

- Case : polyester
- Contacts : silver
- Membrane : nitrile on 83 139 0
silicone on 83 139 1 - 2 - 5

Actuators :

- stainless steel
- rollers : polyamide

- The NO and NC circuits must both be of the same polarity.

Characteristics specific to 83 139 1

- Conform to standards EN 50 014 and 50 018
- Group II classified for explosive atmospheres other than mines subject to firedamp
- Temperature class T6, max. surface temperature 85°C
- LCIE certificate 880022U
- These switches can be enclosed in an envelope of a certified material, particularly to provide mechanical protection

- Degree of protection IP 67.

Operating curve

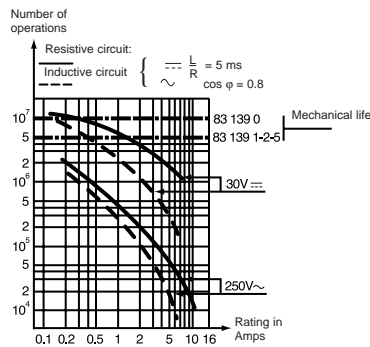

Types

Features

Electrical characteristics

	Nominal	A
Current rating at 125-250 V		

Mechanical characteristics

Operating force - max.	N (oz)
Release force - min.	N (oz)
Max. total travel force	N (oz)
Overtravel max. - force	N (oz)
Maximum rest position	mm (in)
Tripping point	mm (in)
Movement differential	mm (in)
Overtravel - min.	mm (in)
Operating temperature	°C (F°)
Mechanical life	Operations
Contact gap	mm (in)
Weight	g (oz)

Contact Type

C (Form C) SPDT

Mounting Holes

4 holes = A standard

2 holes = B

Connections

Lead position bottom - standard

Lead position right

Lead position left

Actuators

Part numbers for standard actuators

Actuator-Length mm (in)

Operating force - max.	N (oz)
Release force - min.	N (oz)
Movement differential	mm (in)

Part numbers for standard actuators

Actuator-Length mm (in)

Operating force - max.	N (oz)
Release force - min.	N (oz)
Movement differential	mm (in)

Other information

For other forces, actuators, connections and temperatures, lead lengths, please consult factory.

 Normally stocked items

 Catalog products produced to order

Products and specifications subject to change without notice.

Order/Technical Support – Tel: (800) 677-5311 / FAX: (800) 677-3865 / www.crouzet-usa.com



83 139 0	83 139 5	83 139 2	83 139 1
-----------------	-----------------	-----------------	-----------------

Standard	Low temperature	Double insulation to NFC 20030 standard classe II	Explosion proof EEX d 11C T6
5	5	5	5
3 (10.6)	3 (10.6)	3 (10.6)	3 (10.6)
0.6 (2.1)	0.6 (2.1)	0.6 (2.1)	0.6 (2.1)
4 (14.1)	4 (14.1)	4 (14.1)	4 (14.1)
10 (35.3)	10 (35.3)	10 (35.3)	10 (35.3)
A = 8.8 (.35) B = 9.8 (.39)	A = 8.8 (.35) B = 9.8 (.39)	B = 9.8 (.39)	B = 9.8 (.39)
A:7.7 ^{+0.4} (.30 ^{+0.016}) B:8.7 ^{+0.4} (.32 ^{+0.016})	A:7.7 ^{+0.4} (.30 ^{+0.016}) B:8.7 ^{+0.4} (.32 ^{+0.016})	8.7 ^{+0.4} (.32 ^{+0.016})	A:7.7 ^{+0.4} (.30 ^{+0.016}) B:8.7 ^{+0.4} (.32 ^{+0.016})
0.35±0.1 (.014±.004)	0.35±0.1 (.014±.004)	0.35±0.1 (.014±.004)	0.35±0.1 (.014±.004)
0.3 (.012)	0.3 (.012)	0.3 (.012)	0.3 (.012)
0 to 85 (32 to 185)	0 to 85 (32 to 185)	-40 to 85 (-40 to 185)	-40 to 85 (-40 to 185)
10 ⁷	5 x 10 ⁷	5 x 10 ⁶	5 x 10 ⁶
0.3 x 2 (.012 x .008)	0.3 x 2 (.012 x .008)	0.3 x 2 (.012 x .008)	0.3 x 2 (.012 x .008)
37 (1.3)	37 (1.3)	45 (1.6)	37 (1.3)

C	C	C	C
A	A	B	B
B	B	B	B
4 flexible leads ø 2.8 x 0.75 mm ² length 0.50 m	4 flexible leads ø 2.8 x 0.75 mm ² length 0.50 m	3 lead cable 3 x 0.75 mm ² length 0.50 m	4 flexible leads ø 2.8 x 0.75 mm ² length 0.50 m
B	B	B	B
R	R		R
L	L		L

P	R	A 79 215 740	B 79 507 524	E 79 215 742	G 70 507 529
Flat 139 AX R29.7 (1.17)**	Roller 139 EX R28.7 (1.13)**	Flat 161A R14.2 (.56) – R25.4 (1.0)		Roller 161 E R13.6 (.54) – R24.1 (.94)	
1.5 (5.3)	1.5 (5.3)	2.6 (9.2)	1.7 (6)	2.6 (9.2)	1.7 (6)
0.2 (.7)	0.2 (.7)	0.35 (1.2)	0.2 (.7)	0.35 (1.2)	0.2 (.7)
1.5 (.06)	1.5 (.06)	0.7 (.028)	1.25 (.05)	0.7 (.028)	1.25 (.047)
F 79 218 581	H 79 218 651	Note : When mounting actuators, a light greasing of the switch push-button is recommended.			

Flat 161F R22.3 (1.17)	Dummy roller 161 G R21.8 (.86)
2 (7.1)	2 (7.1)
0.2 (.7)	0.2 (.7)
1.1 (.043)	1.1 (.043)

For more actuators, see 83161

∅
No Actuator

** Factory mounted only

To order, please specify :

1 Switch Type	2 Contact Type	3 Mounting Holes	4 Connection	5 Lead Length	6 Actuators
831390 831391 831392 831395	C	A B	B R L	.5 - 1/2 meter (std) 1 - 1 meter 2 - 2 meter	A F P B H R E G ∅
Example switch is: 831390, DBDT, 4 mounting holes, leads exit bottom, .5 meter cable with A actuator.				To order actuators separately, use 8 digit P/N.	

Products and specifications subject to change without notice.

Order/Technical Support – Tel: (800) 677-5311 / FAX: (800) 677-3865 / www.crouzet-usa.com

Dimensions

83 139 0 - 5 - Mounting A = 4 holes

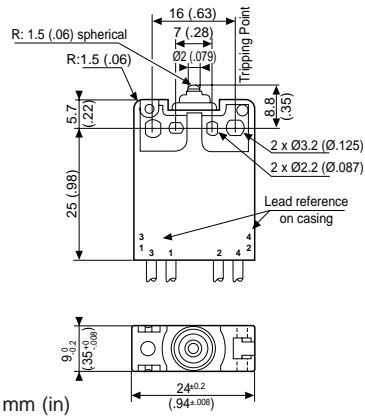

83 139 0 - 1 - 5 - Mounting B = 2 holes

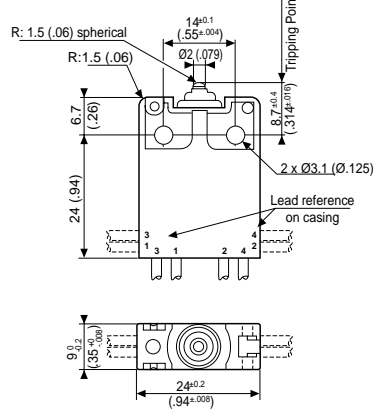

83 139 2

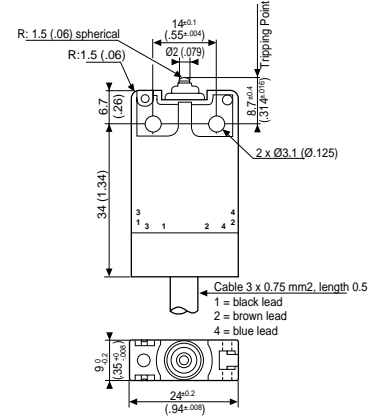

Actuators Factory Mounted Only

Actuators mounting position (type 139)

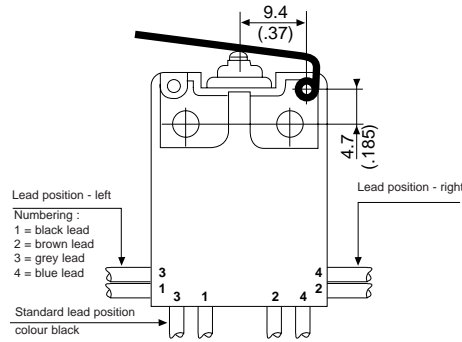
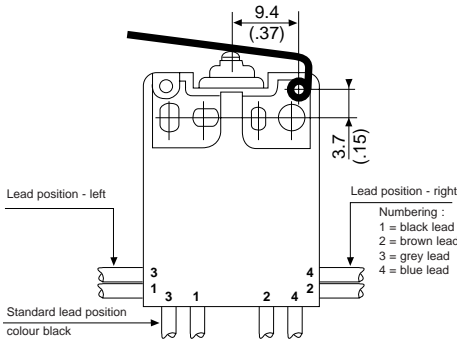

R

P

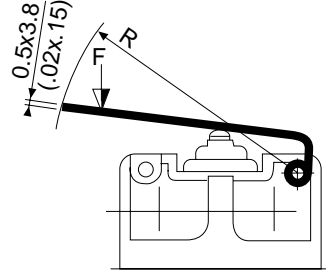
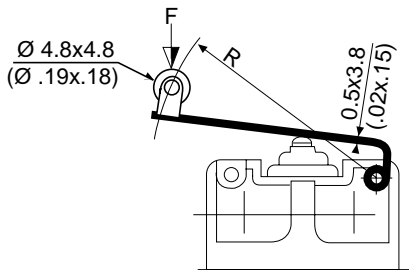

mm (in)

Products and specifications subject to change without notice.

Order/Technical Support – Tel: (800) 677-5311 / FAX: (800) 677-3865 / www.crouzet-usa.com

Actuators User or Factory Mounted

Actuators mounting position (type 161)

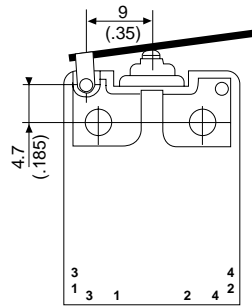
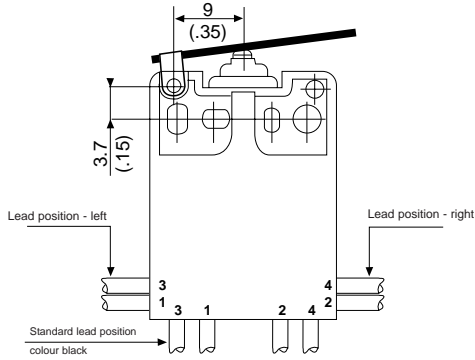

A - B

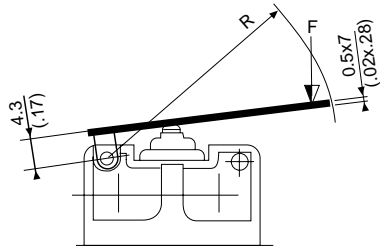

E - G

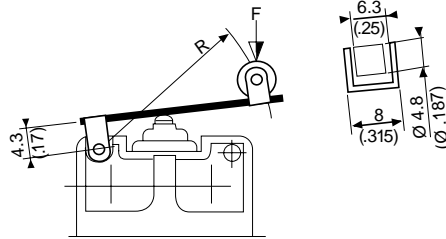

F

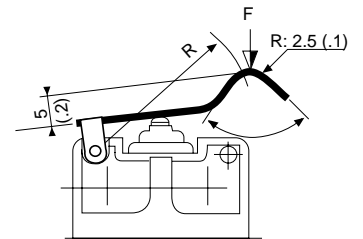

H

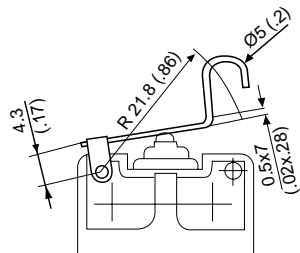

mm (in)

Products and specifications subject to change without notice.

Order/Technical Support – Tel: (800) 677-5311 / FAX: (800) 677-3865 / www.crouzet-usa.com

General specifications

Layout

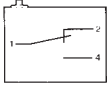

83 169

Components

Material

- Case : polyester UL 94 VO
- Contacts : nickel silver gold alloy (low current)
- Membrane : Fluoro - silicone

Actuators

- stainless steel
- rollers : polyamide
- Plunger : stainless steel

Operating curve

83 169 0

Number of operations

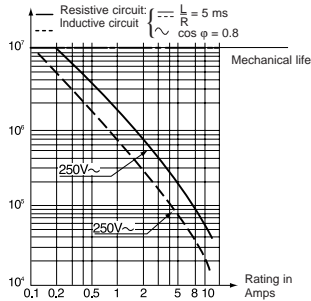

83 169 4

Number of operations

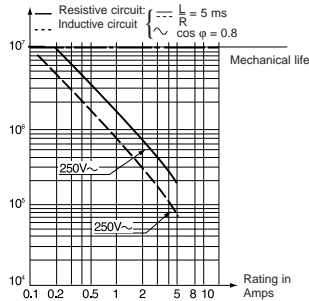

Operating characteristics

83 169 8 and 83 169 9 low current

Intended for use from 1 to 100 mA at 4 to 30 V DC.

Under these conditions, electrical life exceeds mechanical life.

Degree of protection IP 67

Approvals: UL, cUL (CSA Equivalent)

Types

Features

Electrical characteristics

	Nominal	A
Current rating at 125-250 V		

Mechanical characteristics

Operating force - max.	N (oz)
Release force - min.	N (oz)
Maximum overtravel force	N (oz)
Overtravel max. - force	N (oz)
Maximum rest position	mm (in)
Tripping point	mm (in)
Movement differential	mm (in)
Overtravel - min.	mm (in)
Temperature	°C (F°)
Endurance	Operations
Contact gap	mm (in)
Weight	g (oz)

Contact Type

C (Form C) SPDT

Connections

Flexible leads $\varnothing 3 \times 1 \text{ mm}^2$ long 0.50 m

Lead position - right

Lead position - left

3 lead cable - $3 \times 0.75 \text{ mm}^2$ length 0.50 m, left output only

Actuators and mounting positions-user or factory mounted

Part numbers for standard actuators

P

Actuator-Length mm (in.) ** Flat **139 AX R29.7 (1.17)**



Mounting positions

D

Operating force - max.	N (oz)	2.5 (8.8)
Release force - min.	N (oz)	0.4 (1.4)
Movement differential	mm (in)	1.2-0.5 (.047-.02)

Part numbers for standard actuators

Mounting positions	N (oz)
Operating force - max.	N (oz)
Release force - min.	mm (in)
Movement differential	
Unless indicated, flat actuators and roller actuators are delivered unmounted	
** Factory Mounted Only	

Note : When mounting actuators a light greasing of the switch push-button is recommended.

Other information

For other forces, actuators, connections and temperatures, please contact factory.

 Normally stocked items

 Catalog products produced to order

Products and specifications subject to change without notice.

Order/Technical Support – Tel: (800) 677-5311 / FAX: (800) 677-3865 / www.crouzet-usa.com



1

83 169 0 **83 169 4** **83 169 8** **83 169 9**

Standard	Reduced differential movement	Low current	Low current, reduced differential movement
10	5	0.1	0.1
4 (14.1)	4 (14.1)	4 (14.1)	4 (14.1)
1 (3.5)	1 (3.5)	1 (3.5)	1 (3.5)
8 (28.2)	8 (28.2)	8 (28.2)	8 (28.2)
20 (70.5)	20 (70.5)	20 (70.5)	20 (70.5)
15.9 (.63)	15.9 (.63)	15.9 (.63)	15.9 (.63)
14.7 ^{+0.5} (.58 ^{+0.02})	14.7 ^{+0.5} (.58 ^{+0.02})	14.7 ^{+0.5} (.58 ^{+0.02})	14.7 ^{+0.5} (.58 ^{+0.02})
0.35 (.014)	0.07 (.003)	0.35 (.014)	0.07 (.003)
1 (.04)	0.4 (.016)	1 (.04)	0.4 (.016)
-20 to 85 (-4 to 185)	-20 to 85 (-4 to 185)	-20 to 85 (-4 to 185)	-20 to 85 (-4 to 185)
5 x 10 ⁶	5 x 10 ⁶	5 x 10 ⁶	5 x 10 ⁶
0.4 (.016)	0.4 (.016)	0.4 (.016)	0.4 (.016)
30 (1.06)	30 (1.06)	30 (1.06)	30 (1.06)

2

C **C** **C** **C**

3

R	R	R	R
L	L	L	L
C ⁽¹⁾	C	C	C

(1) 83 169 0 Cable limits current to 8 Amps

4

R **A 79 215 740** **B 70 507 524** **E 79 215 742** **G 70 507 529**
 **Roller 139 EX R28.7 (1.13) Flat 161 A R14.2 (.56) - R25.4 (1) Roller 161 E R13.6 (.54) - R24.1 (.95)

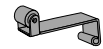

D
2.5 (8.8)
0.4 (1.4)
1.2-0.5 (.047-.02)

A	B	A	B	C
2.5 (8.8)	4.2 (14.8)	1.4 (4.9)	2.5 (8.8)	3.5 (12.3)
0.5 (1.8)	1 (3.5)	0.25 (.88)	0.5 (1.8)	0.6 (2.1)
0.8 (.032)	0.4 (.016)	1.6 (.063)	0.8 (.032)	0.6 (.024)

A	B	A	B	C
2.5 (8.8)	4.2 (14.8)	1.4 (4.9)	2.5 (8.8)	3.5 (12.3)
0.5 (1.8)	1 (3.5)	0.25 (.88)	0.5 (1.8)	0.6 (2.1)
0.8 (.032)	0.4 (.016)	1.6 (.063)	0.8 (.032)	0.6 (.024)

F 79 218 581
Flat 161 F R22.3 (.88)

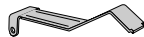

A	B
1.5 (5.3)	2.6 (9.2)
0.25 (.9)	0.5 (1.8)
16 (.63)	0.8 (.032)

H 79 218 651
Dummy roller 161 G R21.8 (.86)



A	B
1.5 (5.3)	2.6 (9.2)
0.25 (.9)	0.5 (1.8)
16 (.63)	0.8 (.032)

Ø
No Actuator

For more actuators see 83161

5

To order, please specify :

Example : 831690 C R .5 * Ø _

1 Switch Type	2 Contact Type	3 Connections	4 Length of Leads	5 Actuator	6 Actuator Position
831690 831694 831698 831699	C	R L C	.5 - 1/2 meter (std) 1 - 1 meter 2 - 2 meter	Ø A B H	E F P R

Example switch is: 831690, SPDT, leads exit right, .5 meter leads, with no actuator. To order actuators separately, use the 8 digit P/N.

Products and specifications subject to change without notice.

Order/Technical Support – Tel: (800) 677-5311 / FAX: (800) 677-3865 / www.crouzet-usa.com

Sealed Miniature Switches

Dimensions

Output wires

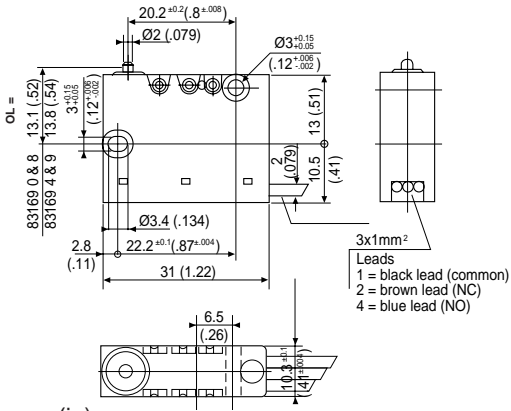

Output cable

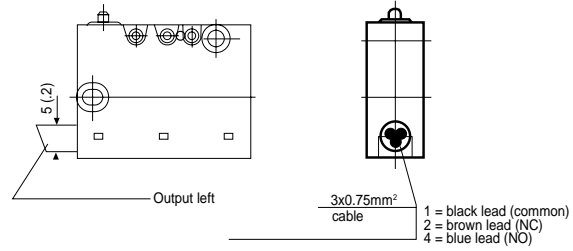

mm (in)

Actuators

Mounting position for factory mounted actuators

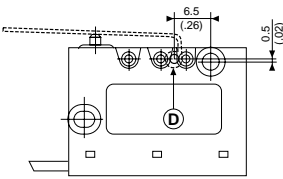

Mounting position for factory or customer mounted actuators

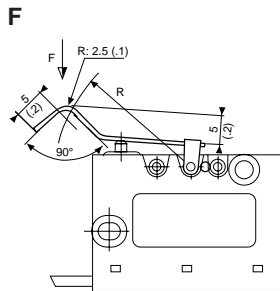
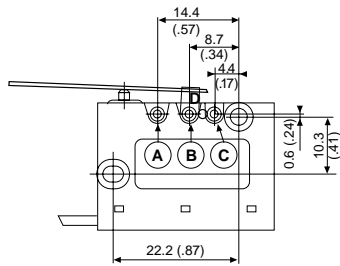

mm (in)

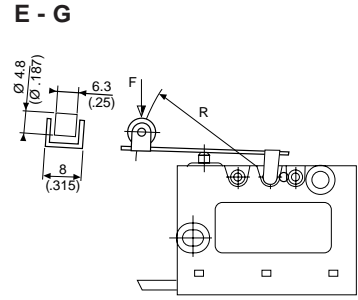
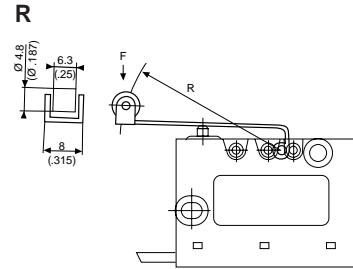
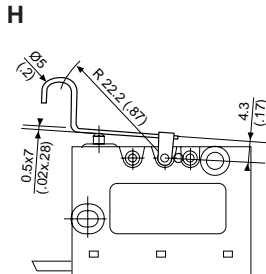
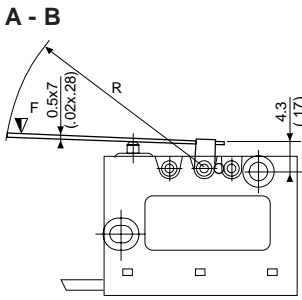
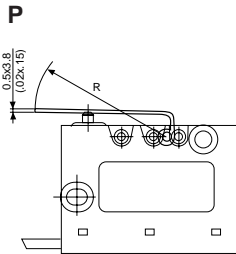

Products and specifications subject to change without notice.

Order/Technical Support – Tel: (800) 677-5311 / FAX: (800) 677-3865 / www.crouzet-usa.com

Sealed Flat Pack Switches Series 83 123 IP 66

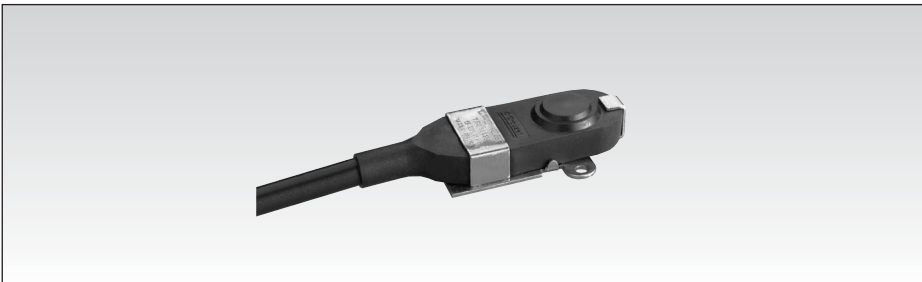

General specifications

Layout

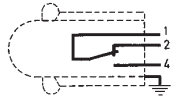

Components

Material

- Casing : nitrile
- Contacts : silver
- Contact holder : polyamide
- Mounting plate : passivated mild steel (zinc)

Operating curve

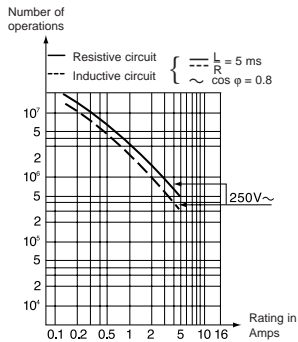

Degree of protection IP 66

Mounting - Operation

In order to comply with basic safety requirements, an insulator must be used if the device is being operated manually. One of the fixing holes must be used as a protective earth.

Types

Features	83 123 0 Standard	83 123 0 Raised Button
Electrical characteristics		
Current rating at 250 V	Nominal A	5
	Thermal A	12
Mechanical characteristics		
Operating force - max.	N (oz)	5.3 (18.7)
Release force - min.	N (oz)	1.5 (5.3)
Total travel force - max.	N (oz)	8 (28.2)
Permitted overtravel force - max.	N (oz)	30 (106)
Tripping point	mm (in)	11.4 ^{+0.4} (.45 ^{+0.016})
Differential travel	mm (in)	0.2 (.008)
Overtravel - min.	mm (in)	0.2 (.008)
Maximum operating temperature	°C (F°)	0+85 (32+185)
Mechanical durability	Operations	2 x 10 ⁶
Contact gap	mm (in)	0.2 (.008)
Weight	g (oz)	45 (1.6)

Contact Type

C (Form C SPDT)

C

C

Connections

Output by A05 VVF cable, 3 x 0.75 mm² cores in sheath of 7.6 mm ext. Ø.

Standard length 0.50 m

Common (1) : black
Normally closed (2) : brown
Normally open (4) : blue

Dimensions

Standard 83 123

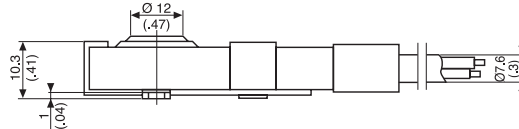

Raised button 83 123

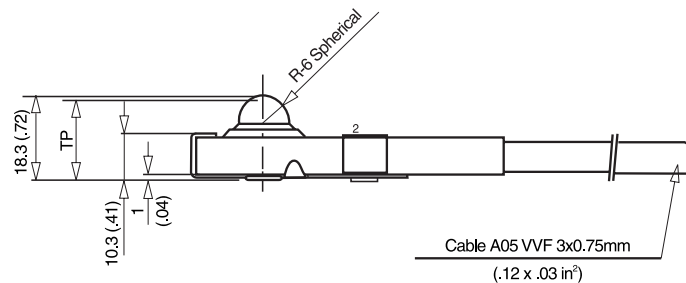
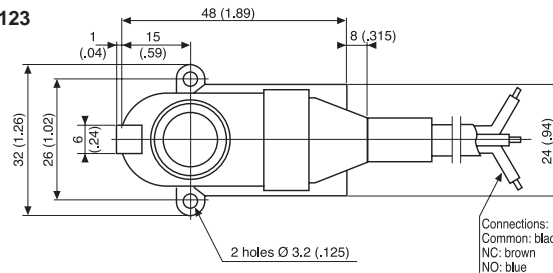

mm (in)

Other information	To order, specify :	
For other cable lengths and temperatures, please consult us.	Standard	Raised Button
	0.5m = 83 123 018	83 123 018.RB
	1.0m = 83 123 015	83 123 015.RB
	2.0m = 83 123 005	83 123 005.RB

Products and specifications subject to change without notice.

Order/Technical Support – Tel: (800) 677-5311 / FAX: (800) 677-3865 / www.crouzet-usa.com

Low Force Position Detectors Series 81 290

- Conforms to standard DIN 43365 Form A
- Low activation force < 1.7 oz. (50 g @ at 6 bars) at 90 psi
- No continuous consumption of compressed air

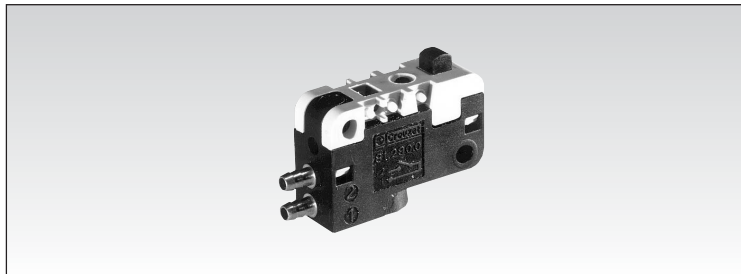

Part numbers

Contact type	(Form B) SPNC	81 290 501	—
	(Form A) SPNO	—	81 290 001

1

Symbol

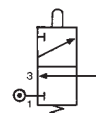
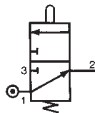

Characteristics

Orifice diameter	inches(mm)	5/64" (2)	5/64" (2)
Operating pressure	psi(bar)	30 > 120 (2 > 8)	30 > 120 (2 > 8)
Flow at 60 psi(4 bars)	cfm(Nl/min)	4.5 (130)	2.5 (>70)
Activation force at 90 (6 bars)	ounces(g)	<1.7 (< 50)	<1.7 (< 50)
Permissible fluid: air, inert gases		●	●
Max/min. of fluid temperatures	°F(°C)	+20> +120 (-10 > +50)	+20> +120 (-10 > +50)
operating	°F(°C)	+20> +140 (-10 > +60)	+20> +140 (-10 > +60)
storage	°F(°C)	+20> +160 (-40 > +70)	+20> +160 (-40 > +70)
Mechanical life at 90psi (6 bars)	cycles	10 million	10 million
Response on activation	ms	15	15
time on release	ms	15	15
Barb connection for semi-rigid tubing	inches(mm)	0.106" I.D. x 5/32" O.D. (2.7x4)	0.106" I.D. x 5/32" O.D. (2.7x4)
Weight	grams	8.5	8.5

Principle of NC operation

Deactivated

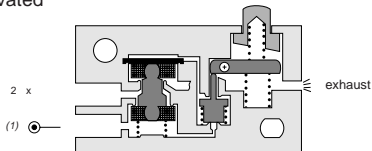

Activated

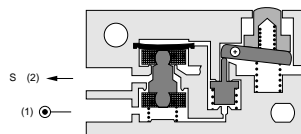

Operation accessories

Unless otherwise requested, flat and roller-ended actuators are supplied loose.

161 A
flat
79 215 741

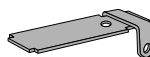

161 E
roller
79 215 743

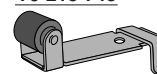

2

Dimensions

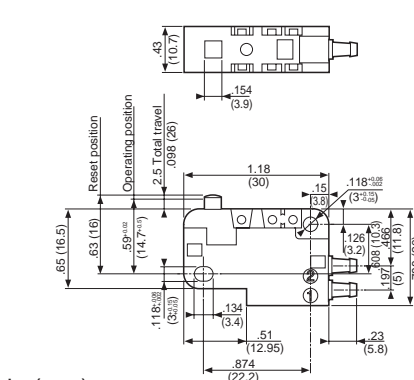

in (mm)

Use (metric) dimensions for critical data

161 A

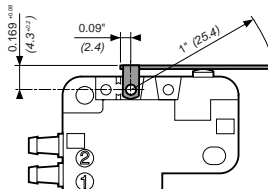

161 E

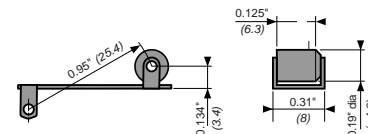

Other information	To order, specify :
On request : Wide range of actuators Connectable exhaust	<p>Standard products</p> <p>1 Part number 2 Accessory</p> <p>Example : Low force position detector 81 290 501 Flat actuator 79 215 741</p>

Products and specifications subject to change without notice.

Order/Technical Support – Tel: (800) 677-5311 / FAX: (800) 677-3865 / www.crouzet-usa.com

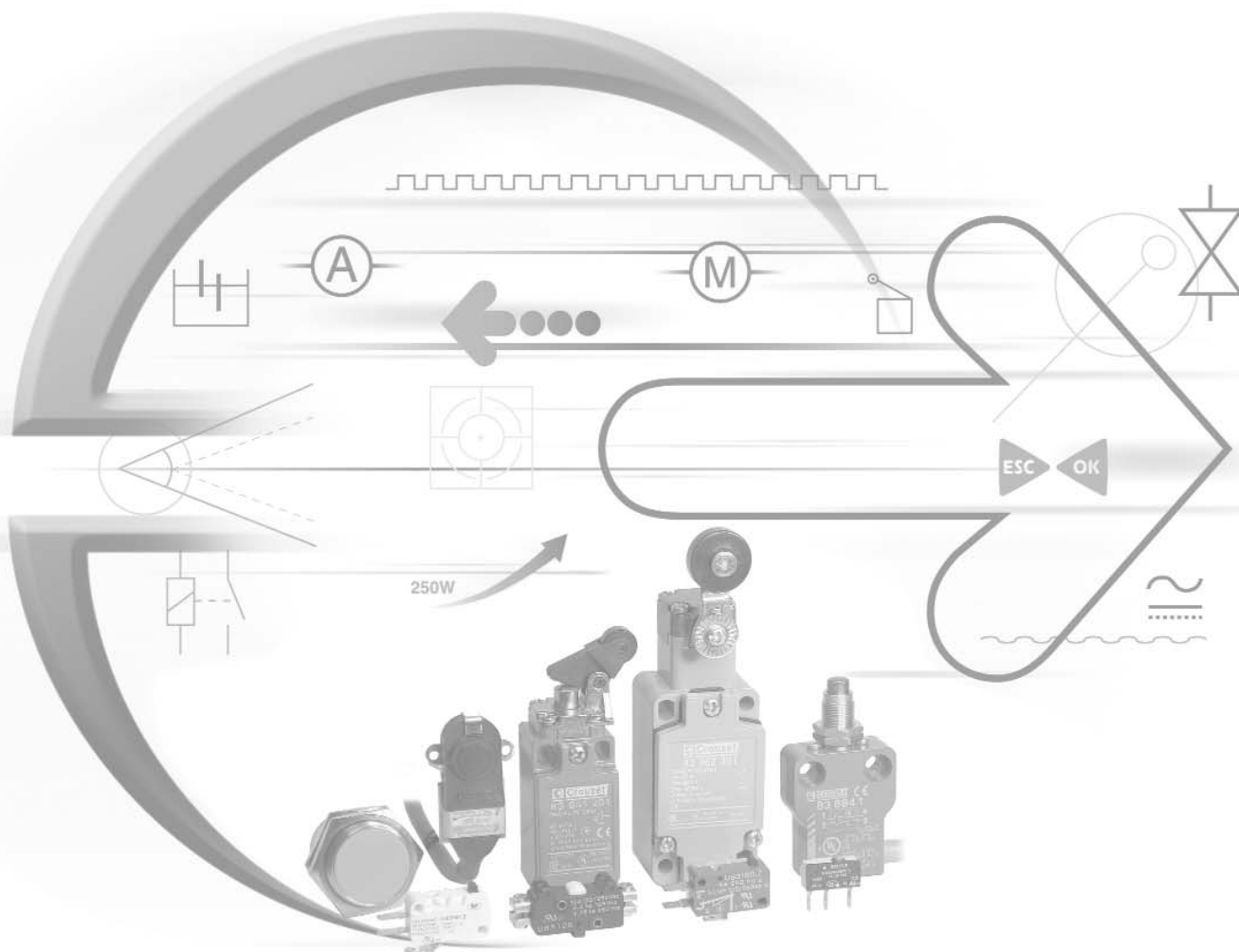

Industrial Limit Switches



Products and specifications subject to change without notice.

Order/Technical Support – Tel: (800) 677-5311 / FAX: (800) 677-3865 / www.crouzet-usa.com

Miniature Industrial Limit Switches Series 83 852 / 83 853 EN 50047

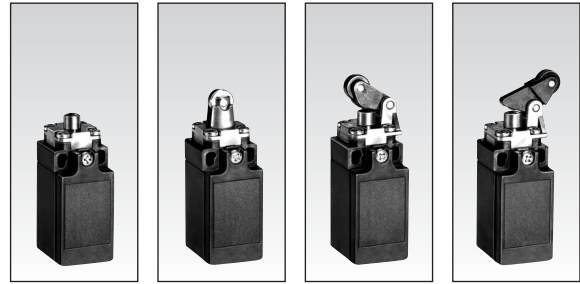

Conform to the following standards :

IEC 536-1, IEC 947-5-1, CSA C22.2 No. 14, EN 50047, EN 60947-5-1, EN 60204-1, NFC 20030 class I for 83 852 class II for 83 853 UL 508, VDE 0660/200.

Degree of protection : IP 66
Version : 1 pole

Function : Four-terminal double break contact element (form Zb) with positive opening NC contacts. The two moving contacts are electrically isolated from one another.

Principle :

Independent snap action contact
1 NO + 1 NC

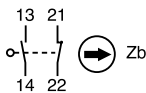

Dependent action
1 NO + 1 NC

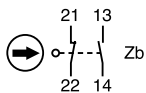

Break Before Make

Electrical characteristics

Assigned insulation voltage (U_i) : 500 V
Thermal rating (I_{th}) : 10 A
Use category : A300 - Q300
AC15 = 6A/250 V - 1.9 A / 380 V
DC 13 = 3A/24 V

Short circuit test (under IEC 947.5.1 § 8.3.4)

- Current peak 1000 A at 250 V ~ 0.5 < cos φ < 0.7
- Short circuit protection (SCPD) : fuse 10 A gF
- Electrical protection by internal earth terminal (83 852)

Connections :

Saddle washer and M 3.5 screw
Max. wire cross-section : 2 x 1.5 mm² or 1 x 2.5 mm²

Connection :

For 1/2" NPT

Approvals :

UL listed A300 - Q300 - CSA A300 - Q300

Types

Thermoplastic case with double insulation and metal actuator head	Independent snap action NC + NO	83 853 001	83 853 501	83 853 101	83 853 201
	Dependent action NC + NO	83 853 011	83 853 511	83 853 111	83 853 211
Metal bodies and actuator heads	Independent snap action NC + NO	83 852 001	83 852 501	83 852 101	83 852 201
	Dependent action NC + NO	83 852 011	83 852 511	83 852 111	83 852 211
Control mechanisms - adjustable actuator heads 4 positions 90°		•	•	•	•
Steel plunger		•			
Plunger with steel roller			•		
Lever with plastic roller	vertical			•	
	lateral				•
Rotary head, momentary action to right and left ⁽¹⁾					
With lever and plastic roller	Ø 22 offset 40				
	Ø 19 offset 53				
	Ø 50 offset 47				
	offset 53.5				
With adjustable lever and plastic roller	Ø 22 offset 32.5 or 45				
	offset 46				
	Ø 50 adjustable offset 53.5 to 69.5				
With adjustable polyamide rod actuator					
Flexible metal lever					

⁽¹⁾ Action either right or left according to position of head

Sequence

Independent snap action
Dependent action

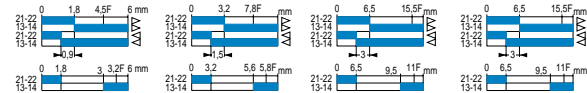

Positive break operation



Mechanical characteristics

Minimum operating force	N (oz.)	10 (35.3)	10 (35.3)	9 (31.7)	9 (31.7)
Minimum total travel force	N (oz.)	12 (42.3)	12 (42.3)	10 (35.3)	10 (35.3)
Minimum positive opening force	N (oz.)	25 (88.2)	25 (88.2)	20 (70.5)	20 (70.5)
Minimum operating travel	mm (in.)	5 (.2)	5 (.2)	5 (.2)	5 (.2)
Minimum positive opening travel	mm (in.)	6 (.24)	6 (.24)	6.5 (.247)	6.5 (.247)
Differential travel	mm (in.)	1.5 (.06)	1.5 (.06)	1.5 (.06)	1.5 (.06)
Max. total travel	mm (in.)	6 (.24)	6 (.24)	6 (.24)	6 (.24)
Mechanical life (millions of operations) mini.		15	15	15	15
Temperature limits	Use °C (°F)	-25+80(-13+176)	-25+80(-13+176)	-25+80(-13+176)	-25+80(-13+176)
	Stored °C (°F)	-40+80(-40+176)	-40+80(-40+176)	-40+80(-40+176)	-40+80(-40+176)
Degree of protection		IP 66	IP 66	IP 66	IP 66
Weight	Series 83 853 g (oz.)	90 (3.2)	100 (3.5)	100 (3.5)	105 (3.7)
	Series 83 852 g (oz.)	170 (6)	180 (6.3)	180 (6.3)	180 (6.3)

Other information

For other contact types and accessories or special modes of operation : please consult us.
For dimensions see page 3/38.

Replacement contact block

Part number	Configurations	Function
83157401	SPDT	<STD>
83157402	SPDT	Break before make
83157403	SPDT	Make before break
83157404	2 NO	DPST - Normally open
83157405	2 NC	DPST - Normally closed

Products and specifications subject to change without notice.

Order/Technical Support – Tel: (800) 677-5311 / FAX: (800) 677-3865 / www.crouzet-usa.com



1

83 853 301	83 853 302	83 853 305	83 853 306	83 853 303	83 853 307	83 853 308	83 853 304	83 853 601
83 853 311	83 853 312	83 853 315	83 853 316	83 853 313	83 853 317	83 853 318	83 853 314	83 853 611
83 852 301	83 852 302	83 852 305	83 852 306	83 852 303	83 852 307	83 852 308	83 852 304	83 852 601
83 852 311	83 852 312	83 852 315	83 852 316	83 852 313	83 852 317	83 852 318	83 852 314	83 852 611

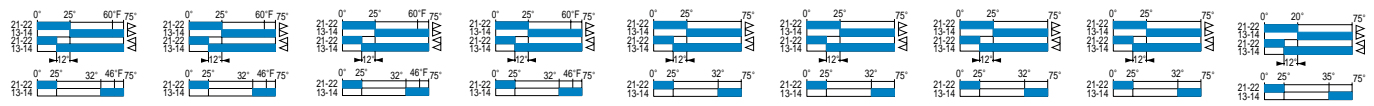
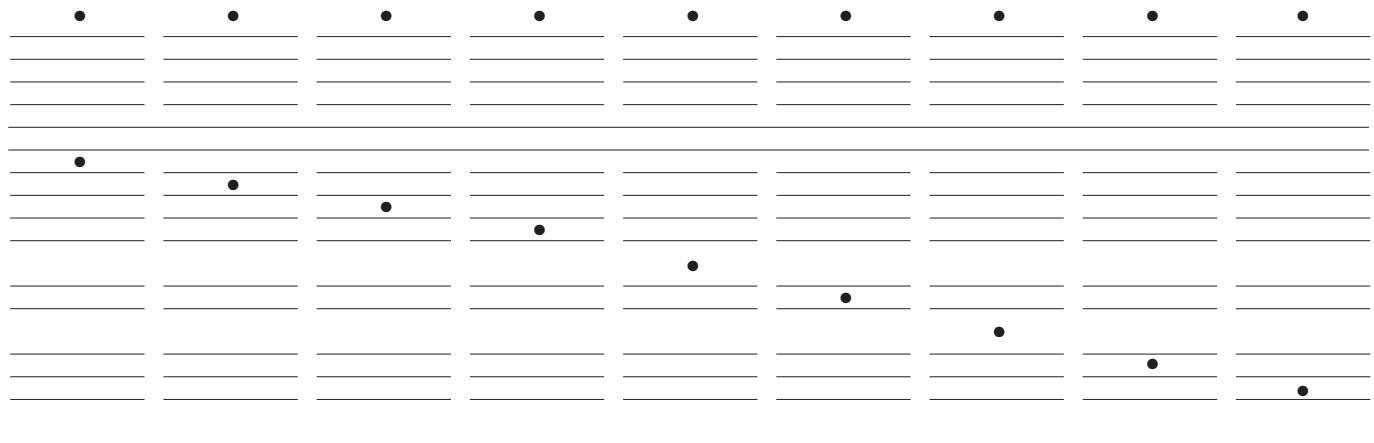

28cmN (40inoz)	28cmN (40inoz)	28cmN (40inoz)	28cmN (40inoz)	28cmN (40inoz)	28cmN (40inoz)	28cmN (40inoz)	28cmN (40inoz)	3 (10)
37cmN (52inoz)	37cmN (52inoz)	37cmN (52inoz)	37cmN (52inoz)	37cmN (52inoz)	37cmN (52inoz)	37cmN (52inoz)	37cmN (52inoz)	4.5 (16)
75cmN (106inoz)	75cmN (106inoz)	75cmN (106inoz)	75cmN (106inoz)	75cmN (106inoz)	75cmN (106inoz)	75cmN (106inoz)	75cmN (106inoz)	
30°	30°	30°	30°	30°	30°	30°	30°	30°
60°	60°	60°	60°	60°	60°	60°	60°	
20°	20°	20°	20°	20°	20°	20°	20°	20°
75°	75°	75°	75°	75°	75°	75°	75°	75°
15	15	15	15	15	15	15	15	15
-25+80(-13+176)	-25+80(-13+176)	-25+80(-13+176)	-25+80(-13+176)	-25+80(-13+176)	-25+80(-13+176)	-25+80(-13+176)	-25+80(-13+176)	-25+80(-13+176)
-40+80(-40+176)	-40+80(-40+176)	-40+80(-40+176)	-40+80(-40+176)	-40+80(-40+176)	-40+80(-40+176)	-40+80(-40+176)	-40+80(-40+176)	-40+80(-40+176)
IP 66	IP 66	IP 66	IP 66	IP 66	IP 66	IP 66	IP 66	IP 66
130 (4.6)	130 (4.6)	130 (4.6)	130 (4.6)	130 (4.6)	153 (5.4)	153 (5.4)	153 (5.4)	130 (4.6)
205 (7.23)	205 (7.23)	205 (7.23)	205 (7.23)	205 (7.23)	225 (7.93)	225 (7.93)	225 (7.93)	200 (7.1)

To order, specify :

Standard products
 Standard products, non stocked

1 Part number
 Example : Limit switch 83 853 001

Products and specifications subject to change without notice.

Order/Technical Support – Tel: (800) 677-5311 / FAX: (800) 677-3865 / www.crouzet-usa.com



Industrial Limit Switches Series 83 862 EN 50041

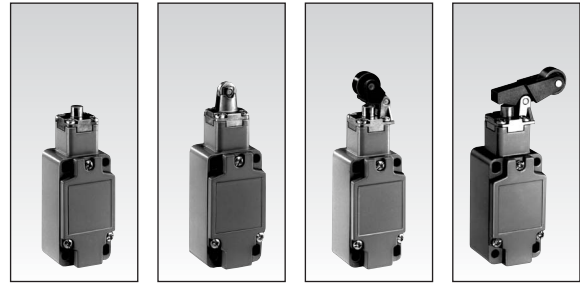

Conform to the following standards :
 EN 50041, IEC 947-5-1, VDE 0660/200
 UL 508, CSA C22.2 No.14
 IEC 536-1, EN 60204-1, NFC 20030
 class I

Degree of protection : IP 66

Function : Four-terminal double break contact element (form Zb) with positive opening NC contacts.
 The two moving contacts are electrically isolated from one another.

Principle :
 Independent snap action contact
 1 NO + 1 NC

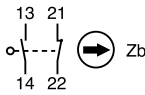

Dependent action
 1 NO + 1 NC

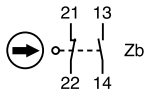

Break before make

Electrical characteristics :

Assigned insulation voltage (Ui) :
 500 V
 Thermal rating (Ith) : 10 A
 Use category : A300 - Q300
 AC15 = 6A/250 V - 1.9 A / 380 V
 DC 13 = 3A/24 V

Short circuit test (under IEC 947.5.1 § 8.3.4)
 - Current peak 1000 A
 at 250 V - 0.5 < cos φ < 0.7
 - Short circuit protection (SCPD) :
 fuse 10 A gF
 - Electrical protection by internal earth terminal

Connections :
 Saddle washer and M 3.5 screw
 Max. wire cross-section : 2 x 1.5 mm²
 or 2.5 mm²

Connection :
 1/2" NPT

Approvals :
 UL listed A300 - Q300 -
 CSA A300 - Q300

Types

	83 862 011	83 862 511	83 862 111	83 862 211
Dependent action NC + NO	83 862 011	83 862 511	83 862 111	83 862 211
Independent snap action NC + NO	83 862 001	83 862 501	83 862 101	83 862 201
Control mechanisms - adjustable actuator heads 4 positions 90°	•	•	•	•
Steel plunger	•			
Plunger with steel roller		•		
Lever with vertical plastic roller			•	
Lever with lateral plastic roller				•

Rotary head, momentary action to clockwise and/or anti-clockwise (1)

	83 862 011	83 862 511	83 862 111	83 862 211
Ø 22 offset 43.5				
With lever and plastic roller				
Ø 19 offset 56				
offset 50.5				
Ø 50 offset 57				
With adjustable lever and plastic roller				
Ø 22 offset 36 or 48				
Ø 50 offset 49				
adjustable offset 57 to 73				
With adjustable polyamide rod actuator				
Flexible metal lever				
Independent snap action				

Sequence

Dependent action

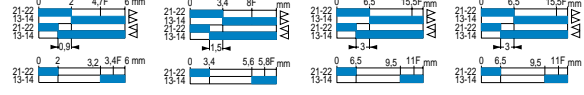

Positive break operation



Mechanical characteristics

Minimum operating force	N (oz.)	10 (35.5)	10 (35.5)	9 (31.7)	9 (31.7)
Minimum total travel force	N (oz.)	12 (42.3)	12 (42.3)	10 (35.3)	10 (35.3)
Minimum positive opening travel	N (oz.)	25 (88.2)	25 (88.2)	20 (70.5)	20 (70.5)
Minimum operating travel	mm (in.)	5 (.2)	5 (.2)	5 (.2)	5 (.2)
Minimum positive opening travel	mm (in.)	6 (.24)	6 (.24)	6.5 (.26)	6.5 (.26)
Differential travel	mm (in.)	1.5 (.06)	1.5 (.06)	1.5 (.06)	1.5 (.06)
Max. total travel	mm (in.)	6 (.24)	6 (.24)	6 (.24)	6 (.24)
Mechanical life (millions of operations) mini.		15	15	15	15
Temperature Use	°C (°F)	-25+80(-13+176)	-25+80(-13+176)	-25+80(-13+176)	-25+80(-13+176)
limits Stored	°C (°F)	-40+80(-40+176)	-40+80(-40+176)	-40+80(-40+176)	-40+80(-40+176)
Degree of protection		IP 66	IP 66	IP 66	IP 66
Weight	g (oz.)	305 (10.76)	315 (11.11)	320 (11.28)	325 (11.46)

(1) Action either right or left according to position of head

Accessories

Cover with status indicator (supplied loose)	24.30 V ~ ☐	79 250 290	
	220 V ~	79 250 291	

Replacement contact block

Part number	Configuration	Function
83157401	SPDT	<STD>
83157402	SPDT	Break before make
83157403	SPDT	Make before break
83157404	2 NO	DPST - Normally open
83157405	2 NC	DPST - Normally closed

Other information

For other contact types and accessories or special modes of operation : please consult us.
 For dimensions see page 3/39.

Products and specifications subject to change without notice.

Order/Technical Support – Tel: (800) 677-5311 / FAX: (800) 677-3865 / www.crouzet-usa.com

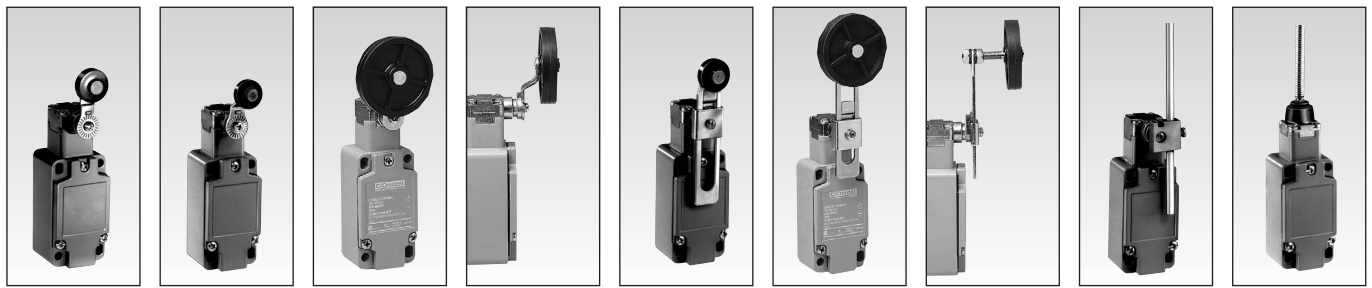

83 862 311	83 862 312	83 862 315	83 862 316	83 862 313	83 862 317	83 862 318	83 862 314	83 862 611
83 862 301	83 862 302	83 862 305	83 862 306	83 862 303	83 862 307	83 862 308	83 862 304	83 862 601
•	•	•	•	•	•	•	•	•
•								
	•							
		•						
			•					
				•				
					•			
						•		
							•	
								•
28cmN (40inoz)	28cmN (40inoz)	28cmN (40inoz)	28cmN (40inoz)	28cmN (40inoz)	28cmN (40inoz)	28cmN (40inoz)	28cmN (40inoz)	3 (10.5)
37cmN (52inoz)	37cmN (52inoz)	37cmN (52inoz)	37cmN (52inoz)	37cmN (52inoz)	37cmN (52inoz)	37cmN (52inoz)	37cmN (52inoz)	4.5 (15.8)
75cmN (106inoz)	75cmN (106inoz)	75cmN (106inoz)	75cmN (106inoz)	75cmN (106inoz)	75cmN (106inoz)	75cmN (106inoz)	75cmN (106inoz)	
30°	30°	30°	30°	30°	30°	30°	30°	30°
60°	60°	60°	60°	60°	60°	60°	60°	
20°	20°	20°	20°	20°	20°	20°	20°	20°
75°	75°	75°	75°	75°	75°	75°	75°	75°
15	15	15	15	15	15	15	15	15
-25+80(-13+176)	-25+80(-13+176)	-25+80(-13+176)	-25+80(-13+176)	-25+80(-13+176)	-25+80(-13+176)	-25+80(-13+176)	-25+80(-13+176)	-25+80(-13+176)
-40+80(-40+176)	-40+80(-40+176)	-40+80(-40+176)	-40+80(-40+176)	-40+80(-40+176)	-40+80(-40+176)	-40+80(-40+176)	-40+80(-40+176)	-40+80(-40+176)
IP 66	IP 66	IP 66	IP 66	IP 66	IP 66	IP 66	IP 66	IP 66
340 (12)	340 (12)	340 (12)	340 (12)	365 (12.8)	365 (12.8)	365 (12.8)	360 (12.7)	335 (11.8)



To order, specify :

Standard products **1** Part number
 Example : Limit switch 83 860 001

Standard products, non stocked **1** Type **2** Accessory
 Example : Limit switch 83 861 001 - Cover with status indicator 79 250 290

Products and specifications subject to change without notice.

Order/Technical Support – Tel: (800) 677-5311 / FAX: (800) 677-3865 / www.crouzet-usa.com

Dimensions of 83 852 / 83 853 EN 50047

83 852 001/011
83 853 001/011

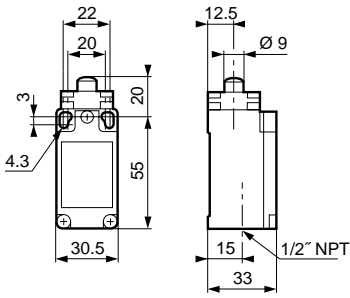

83 852 501/511
83 853 501/511

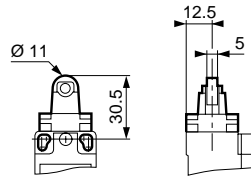

83 852 101 - 201/211
83 853 101 - 201/211

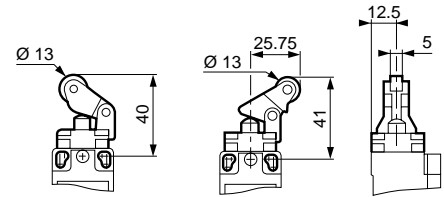

83 852 301/311
83 853 301/311

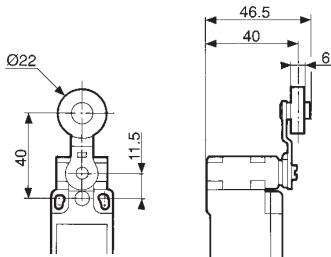

83 852 302/312
83 853 302/312

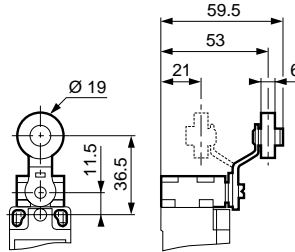

83 852 305/315
83 853 305/315

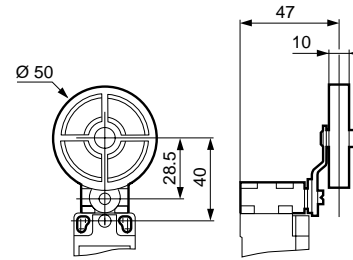

83 852 306/316
83 853 306/316

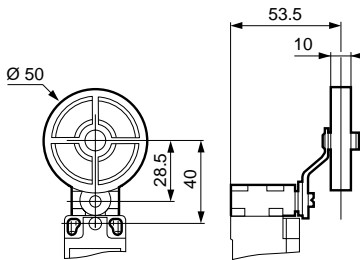

83 852 303/313
83 853 303/313

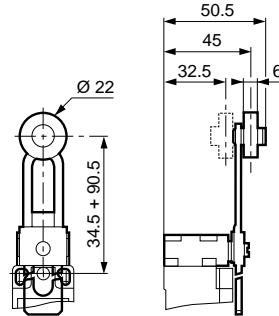

83 852 307/317
83 853 307/317

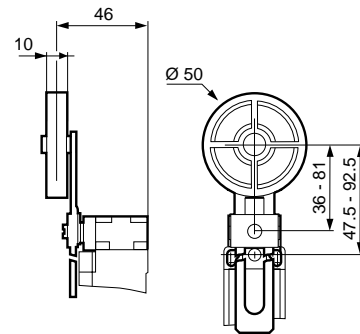

83 852 308/318
83 853 308/318

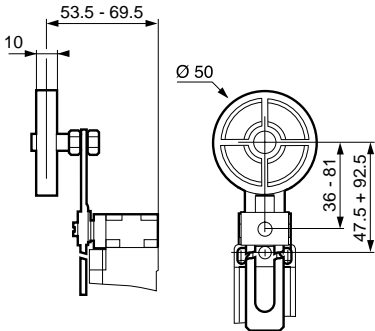

83 852 304/314
83 853 304/314

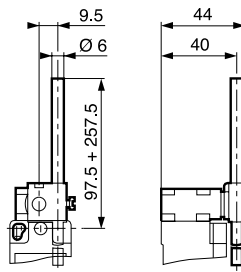

83 852 601/611
83 853 601/611

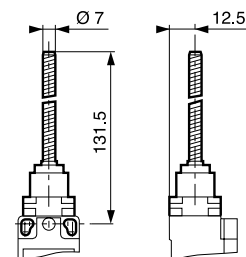

mm

Products and specifications subject to change without notice.

Order/Technical Support – Tel: (800) 677-5311 / FAX: (800) 677-3865 / www.crouzet-usa.com

Dimensions of 83 862 EN 50041

83 862 001/011

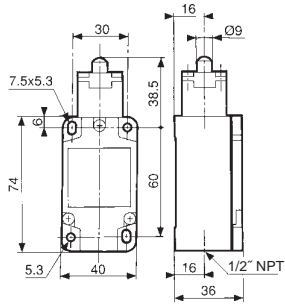

83 862 501/511

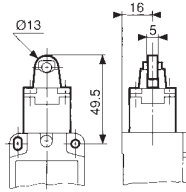

83 862 101/111 – 201/211

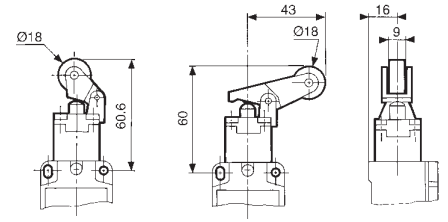

83 862 301/311

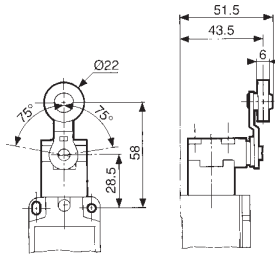

83 862 302/312

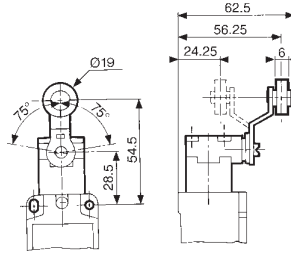

83 862 305/315

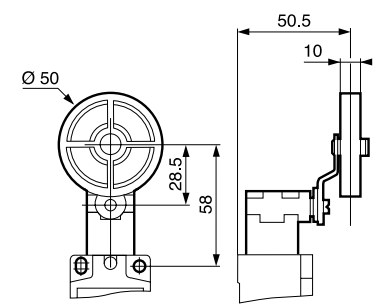

83 862 306/316

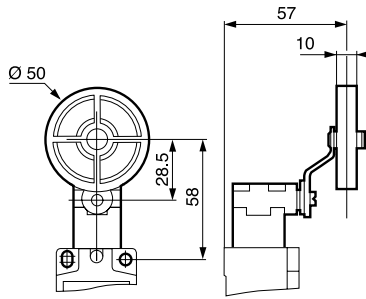

83 862 303/313

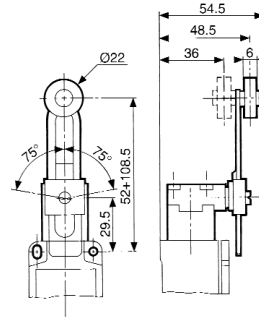

83 862 307/317

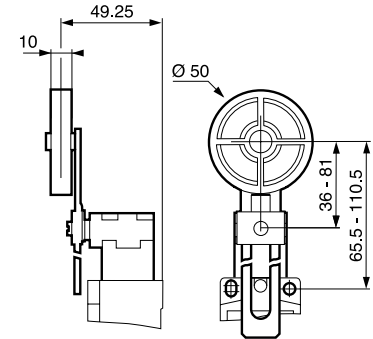

83 862 308/318

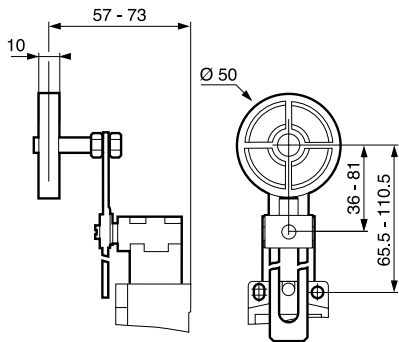

83 862 304/314

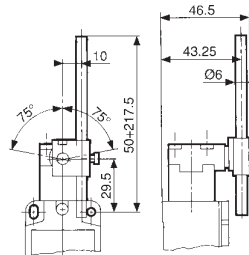

83 862 601/611

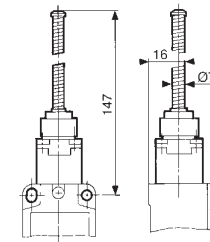

mm

Products and specifications subject to change without notice.

Order/Technical Support – Tel: (800) 677-5311 / FAX: (800) 677-3865 / www.crouzet-usa.com

Positive Opening Enclosed Limit Switches Series 83 870 IP 67

Conforms to the following standards:

IEC / EN 60947.5.1
 Dimensional conformity: NFC 63145
 Low voltage directive: 73/23/EEC and 93/68/EEC
 Protection from electric shock: NFC 20030 or IEC 60536 Class 1, degree of pollution 3.

Temperature specification: -25°/+70°C -13°/+158°F

Degree of protection:

IEC 62529: IP 66/67
 NEMA 250: Type 1, 3, 4, 6, 13

Function:

Contact block is SPDT with double break contacts (form Zb). The NC contacts are positive opening. The NO and NC contacts are electrically isolated.

Contact type:

Snap action SPDT-DB

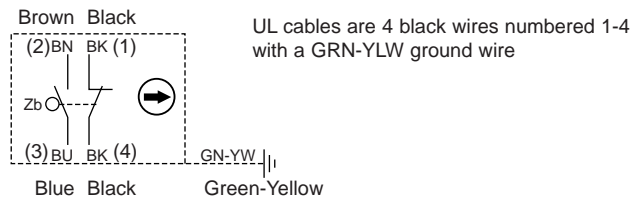

Electrical characteristics

Assigned impulse voltage (Uimp): 2500 V
 Assigned insulation voltage (Ui): 500 V
 Thermal rating (Ith): 10 A
 With standard contacts: Minimum voltage 10V
 Minimum current 100mA

Use categories:

Following IEC 947.5.1 AC15 = 250V / 6A
 DC13 = 24V / 8A
 Following UL 508 A300 - Q150

Electrical protection:

Under IEC 947.5.1
 Short-circuit protection (SCPD): 6AgC fuse
 Electrical protection by internal earth ground

Connections:

Non-UL: 5 conductor cable H05VF 0.75mm² ext. Ø8mm (Black)
 UL: 5 conductor cable (Grey)

Approvals:

UL 508, UL 50

Types

Standard

Roller turned 90°

Standard products 2.0 meter cable* side exit**

Actuator Type

Metal plunger

Metal roller plunger

Metal plunger with threaded barrel

Roller plunger - metal with threaded barrel

Metal roller lever (operates in both directions)

Mechanical characteristics

Operating force minimum oz. (N)

Total travel force minimum oz. (N)

Positive opening force minimum oz. (N)

Mechanical life millions of cycles

Weight oz. (grams)

Contact Sequences

Positions given are nominal

Dimensions

mm

83 870 0

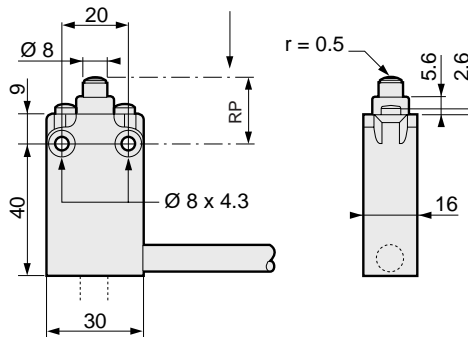

(*) For other lengths of cables:

modify the last digit of the part number. For example:

0 = M12 connector output

1 = 1.0 meter cable

2 = 2.0 meter cable (Standard)

3 = 3.0 meter cable

(**) For different cable outputs:

modify the next to the last digit of the part number.:

0 = Cable side exit (Standard)

1 = Cable bottom exit

2 = Connector side exit

3 = Connector bottom exit

Other information

For different actuator arms, low voltage / low current contacts / low temperature, special contacts, custom wiring harness, etc...., please consult us.

Products and specifications subject to change without notice.

Order/Technical Support – Tel: (800) 677-5311 / FAX: (800) 677-3865 / www.crouzet-usa.com

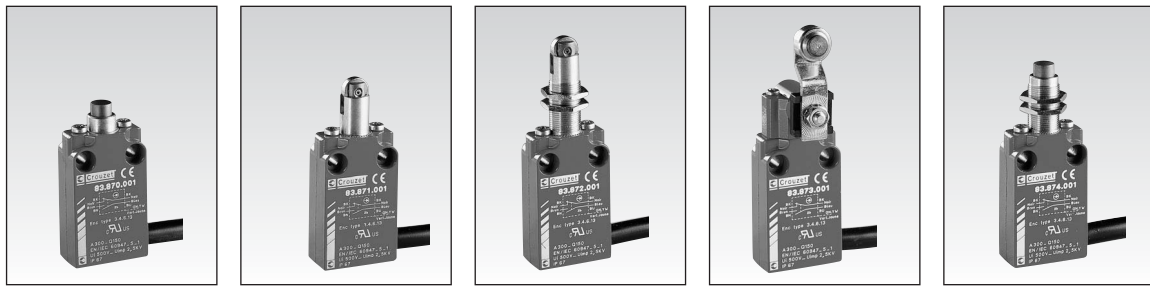

83 870 0	83 871 0	83 872 0	83 873 0	83 874 0
83 870 102	83 871 102	83 872 102	83 873 102	83 874 102
83 870 103	83 871 103	83 872 103	83 873 103	83 874 103

36 (10)	36 (10)	36 (10)	22 in.oz. (15cmN)	36 (10)
108 (30)	108 (30)	108 (30)	52 in.oz. (35cmN)	108 (30)
100 (28)	100 (28)	100 (28)	22 in.oz. (15cmN)	100 (28)
10	10	10	10	10
10.3 (290)	10.4 (295)	11.1 (315)	10.3 (290)	10.9 (310)

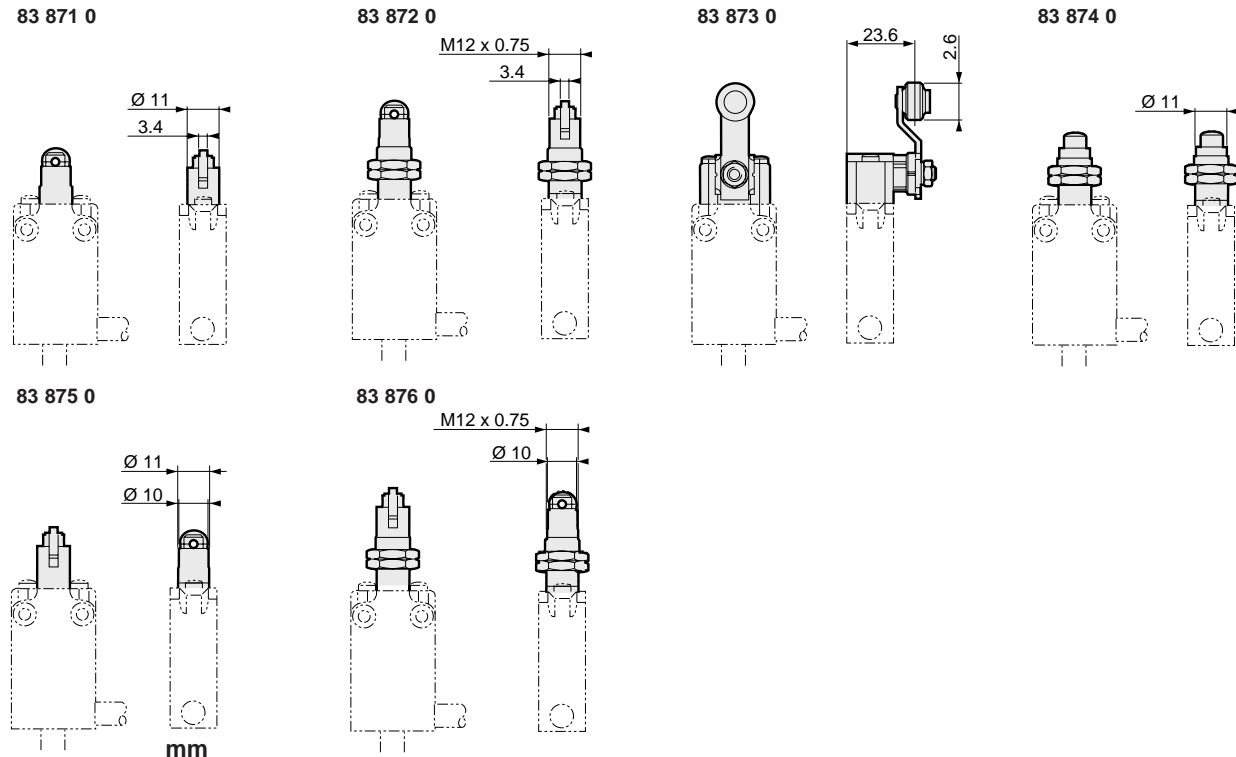
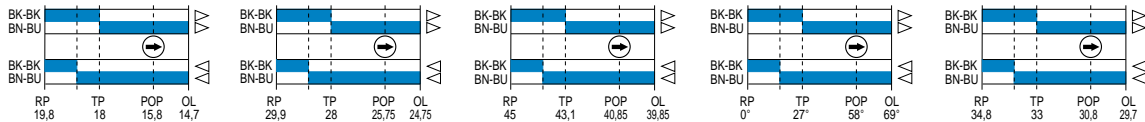

To order, please specify:

Standard products

2 Part number

Example : Limit switch 83 871 102; Cable length = 2m

Standard products, non stocked

1 Type

Examples : Limit switch 83 871 103; cable length = 3 m - Limit switch 83 871 006; cable length = 6 m

Products and specifications subject to change without notice.

Order/Technical Support – Tel: (800) 677-5311 / FAX: (800) 677-3865 / www.crouzet-usa.com

Conforms to the following standards

IEC / EN 60947.5.1
 Dimensional conformity: NFC 63145
 Low voltage directive: 73/23/EEC and 93/68/EEC
 Electric shock protection: NFC 20030 or IEC 60536 class 1, degree of pollution 3.

Temperature specification: -25°/+70°C -13°/+158°F

Degree of protection

According to IEC 62529: IP 66 / 67
 According to NEMA : Type 1, 3, 4, 6, 13

Function

Four-terminal double break contact element (form Zb) with positive opening NC contacts. The two moving contacts are electrically isolated from one another.

Principle

Snap-Action SPDT-DB

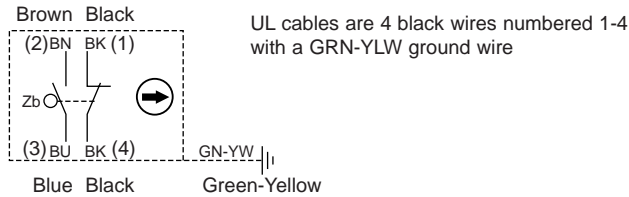

Electrical characteristics

Assigned impulse voltage (Uimp): 2500 V
 Assigned insulation voltage (Ui): 500 V
 Thermal rating (Ith): 10 A
 With standard contacts: Minimum voltage 10 V
 Minimum current 100 mA

Use category:
 according to IEC 947.5.1 AC15 = 250 V / 6 A
 DC 13 = 24 V / 8 A
 according to UL 508 A300 - Q150

Electrical protection

Integral earth wire
 Short-circuit protection device: IEC 947.5.1
 Fuse 6 AgC

Connections

5-core cable HO5VF, 75 mm², ext. Ø 8 mm (non-UL type cable)

Approvals

UL 508, UL 50

Types

Standard
 Plunger or roller at 90°

Standard Part Number (Cable length = 2.0 meters, exit: side)

Actuator Type

Metal plunger
 Metal roller plunger
 Metal plunger with threaded barrel
 Roller plunger - metal with threaded barrel
 Metal roller lever (operates in both directions)

Mechanical characteristics

Minimum positive opening force N (cmN)
 Minimum total travel force N (cmN)

Mechanical life millions of operations
 Weight g

Sequences

Positions: nominal data

Dimensions

83 880

mm

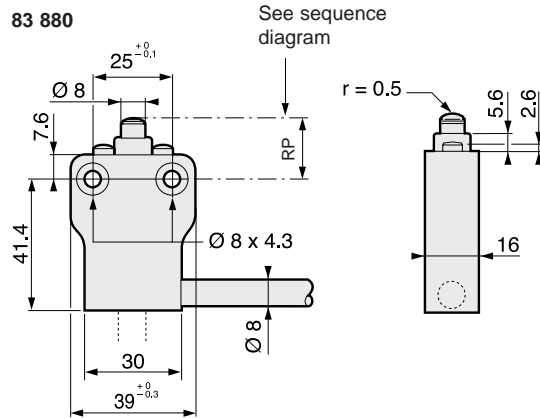

(*) Other cable lengths:

modify the last digit of the part number. For example:

- 0 = M12 connector output
- 1 = 1.0 meter cable
- 2 = 2.0 meter cable (Standard)
- 3 = 3.0 meter cable
- 6 = 6.0 meter cable

(**) For different cable outputs:

modify the next to the last digit of the part number:

- 0 = Cable side exit (Standard)
- 1 = Cable bottom exit
- 2 = Connector side exit
- 3 = Connector bottom exit

Other information

For different actuator arms, low voltage / low current contacts / low temperature, special contacts, custom wiring harness, etc...., please consult us.

Products and specifications subject to change without notice.

Order/Technical Support – Tel: (800) 677-5311 / FAX: (800) 677-3865 / www.crouzet-usa.com

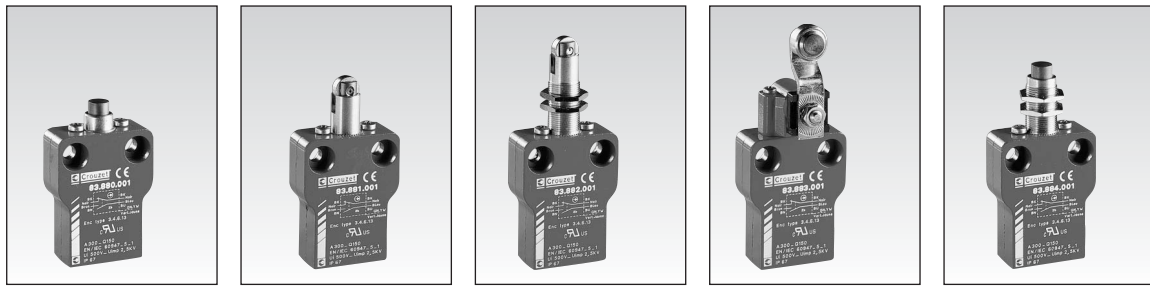

83 880 0	83 881 0	83 882 0	83 883 0	83 884 0	1
83 880 102	83 881 102	83 882 102	83 883 102	83 884 102	2
83 880 103	83 881 103	83 882 103	83 883 103	83 884 103	

36 (10)	36 (10)	36 (10)	22 in.oz. (15cmN)	36 (10)
108 (30)	108 (30)	108 (30)	52 in.oz. (35cmN)	108 (30)
100 (28)	100 (28)	100 (28)	22 in.oz. (15cmN)	100 (28)
10	10	10	10	10
10.3 (290)	10.4 (295)	11.1 (315)	10.3 (290)	10.9 (310)

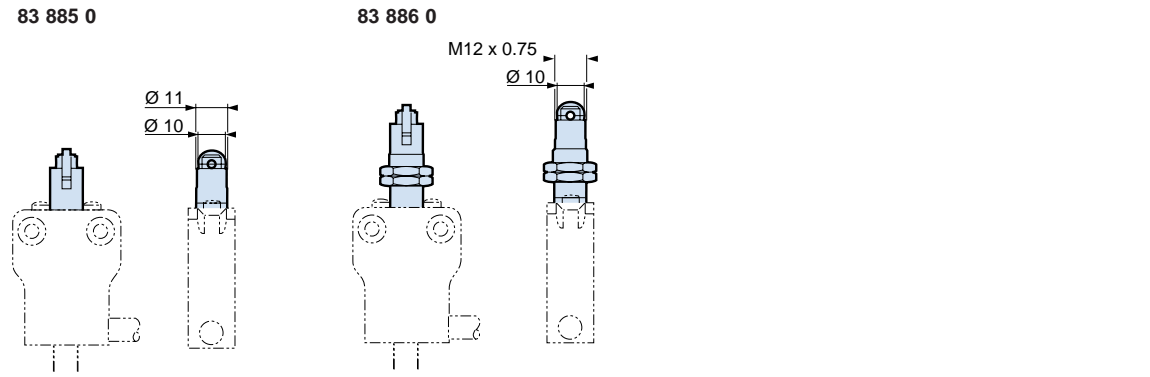
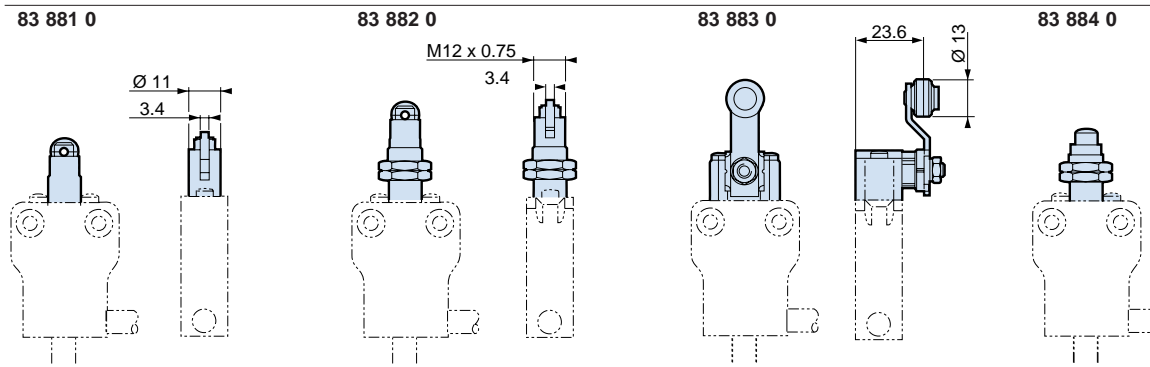
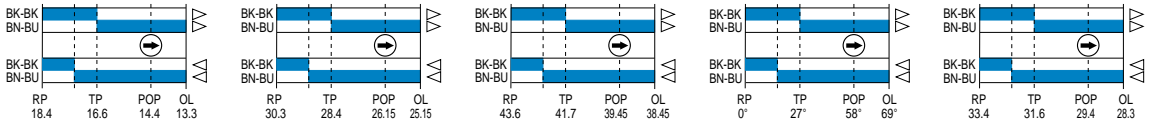

mm

To order, specify:

Standard products	2 Part number Example: Limit switch 83 881 102
Standard products, non stocked	1 Type Examples: Limit switch 83 881 003 ; cable length = 3 m - Limit switch 83 881 006 ; cable length = 6 m

Products and specifications subject to change without notice.

Order/Technical Support – Tel: (800) 677-5311 / FAX: (800) 677-3865 / www.crouzet-usa.com



Miniature Limit Switches Series 83 800

Degree of protection : IP 55 or IP 65 - Nema 4, 12, 13

Version : SPDT - double break

Function : Four terminal double break contact element (form Za). The contacts must be of the same polarity.

Layout :

A - For 83 803



B - Other types



Electrical characteristics :

Assigned insulation voltage (Ui): 250 V

Current Rating

Assigned working currents (Ie): 5 A

Operating curve :

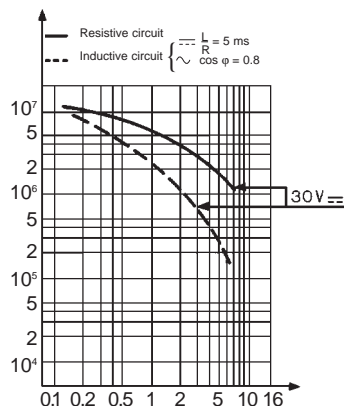

Connections :

- Plug in : Screw terminals - max. wire section 2.5 mm²
- Non Plug in : Solder tags (able to accept 2.8 x 0.5 mm clips).
Contact Crouzet for part # and availability

Connection :

- For N° 9 sealing gland, 15.2 dia., 1.411 pitch
- 25356113 - metal
- 25356109 - plastic

Approvals: UL cUL

Type

Plug in version

Features

- Top mounted plunger
- Top mounted plunger with threaded barrel
- Top mounted roller plunger with threaded barrel
- Side rotary head - momentary
- Top mounted roller plunger
- Flexible metal spring
- Fiberglass Rod

Mechanical Characteristics

Operating force	N (oz)
Total travel force - min.	N (oz)
Operating Travel - min	mm (in)
Movement differential	mm (in)
Total travel - max	mm (in)
Mechanical life	operation
Operating temp.	C° (F°)
Degree of protection	
Weight	grams (oz)

Accessories for 83 803 - Sold separately

* Lever settings or positions dictated by direction in which block is fitted

Adjustable in 6° steps

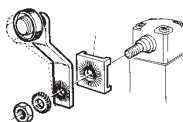

Adjustable in 90° steps

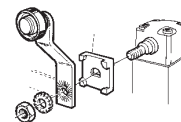

Dimensions

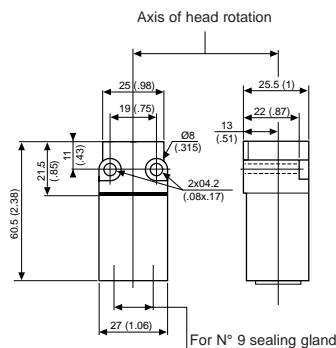

mm(in)

Other information

For other accessories and special contacts, or special modes of operation, please contact factory.
Low temperature version available.

Products and specifications subject to change without notice.

Order/Technical Support – Tel: (800) 677-5311 / FAX: (800) 677-3865 / www.crouzet-usa.com



83800151	83801051	83802051	83803051	83805051	83806051	83807051
•	•	•	•	•	•	•
10 (35.3)	10 (35.3)	10 (35.3)	7 NcM 10 in.oz.	10 (35.3)	1.2 (4.23)	.8 (2.8)
22 (77.6)	22 (77.6)	22 (77.6)	18 NcM 25 in.oz.	22 (77.6)	2.5 (8.8)	2 (7.05)
1.5 (.06)	1.5 (.06)	1.5 (.06)	15°	1.5 (.06)	8°	8°
0.4 (.016)	0.4 (.016)	0.4 (.016)	6°	0.6 (.24)	2°	2°
5 (.2)	5 (.2)	5 (.2)	60°	5 (.2)	10°	10°
10°	10°	10°	10°	10°	10°	10°
-10 to 70 (-14 to 158)	-20 to 70 (-4 to 158)	-20 to 70 (-4 to 158)	-20 to 70 (-4 to 158)	-10 to 70 (-14 to 158)	-10 to 70 (14 to 158)	-10 to 70 (14 to 158)
IP 55	IP 55	IP 55	IP 55	IP 65	IP65	IP65
50 (1.8)	57 (2)	57 (2)	60 (2.1)	50 (1.8)	50 (2.65)	60 (2.1)

Accessories for 83 803 - Sold separately

Galvanized, passivated steel roller arm. Thermoplastic roller.
Lever supplied with nut, washer and locating block (loose).*

79 210 997

Bent roller lever R: 1 1/8" (30mm)



79 210 998

Straight roller lever R: 11/8" (30mm)



79 215 332

Adjustable
Straight roller lever
1 3/16" → 2 7/8"
(28 → 72mm)



Dimensions

83 800

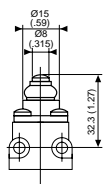

83 801

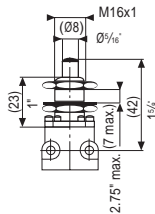

83 802

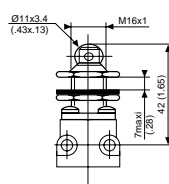

83 803

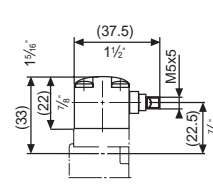

83 805

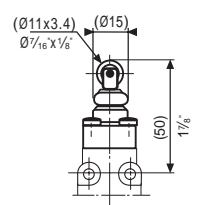

79 210 997

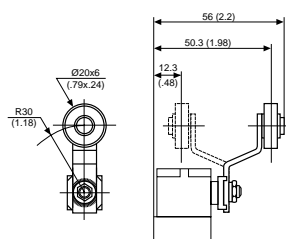

79 210 998

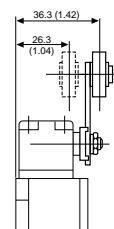

79 215 332

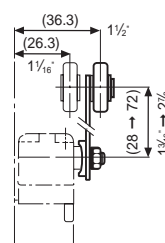

83 806



83 807

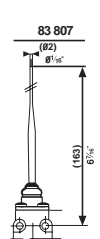

mm(in)

To order, specify:

Standard products	1 Part number Example: 83 800 151
Standard products, non stocked	1 Part number 2 Accessory Example: 83 803 0 - Actuator 79 210 997

Products and specifications subject to change without notice.

Order/Technical Support – Tel: (800) 677-5311 / FAX: (800) 677-3865 / www.crouzet-usa.com

Automotive Limit Switches Series 83 731/ 83 732 / 83 733

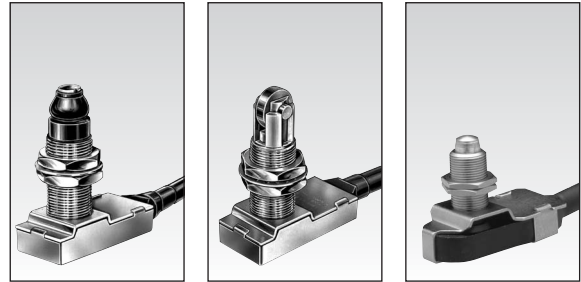

1

Conform to the following standards :
IEC 356.1 - EN 60204.1
NFC 20030 : Class I - 83 731 - 83 732
Class III - 83 733

Degree of protection :
IP 56 - IP 66 depending on type

Version : 1 pole

Function : 3-terminal single break two-way contact element (form C: inverter).

Principle :

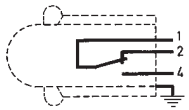

Electrical characteristics :

Assigned operating current (Ie)
83 731 - 83 732 : 5 A 250 V
83 733 : 5 A 50 V
Thermal rating (Ith) : 12 A

Operating curve :

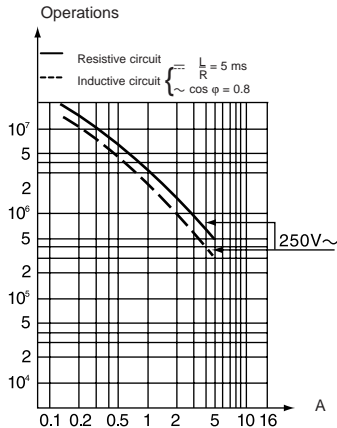

Connections :

PVC cable (A05 - VV - F) 0.50 m long
3 conductors cross-section 0.75 mm²
Sheathed, ext. Ø : 7.6 mm
Core connections : 1 : black (common)
2 : brown (NC)
4 : blue (NO)

Electrical protection :

Earthing terminal for version 83 731 and 83 732.

Approvals :

CSA A300.

Types

		83 731 3	83 732 3	83 733 3
Control mechanisms				
Top-mounted plunger		•		•
Top-mounted plunger with roller			•	
Mechanical characteristics				
Minimum operating force	N (oz.)	15 (53)	15 (53)	6 (21.2)
Minimum total travel force	N (oz.)	35 (123.4)	35 (123.4)	25 (88.2)
Minimum operating travel	mm (in.)	2 (.079)	2 (.079)	1.5 (.059)
Differential travel	mm (in.)	0.2 (.008)	0.2 (.008)	0.2 (.008)
Max. total travel	mm (in.)	6 (.236)	6 (.236)	4 (.157)
Mechanical life	Operations	10 ⁶	10 ⁶	10 ⁶
Temperature limits	°C (°F)	- 5 + 70	- 5 + 70	- 5 + 70
Degree of protection	°C (°F)	IP 66	IP 66	IP 56
Weight	g (oz.)	110 (3.9)	110 (3.9)	70 (2.5)

Dimensions

mm

83 731 3

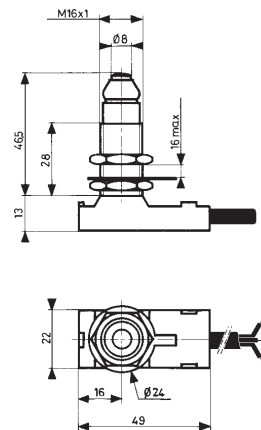

83 732 3

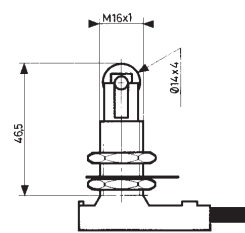

83 733 3

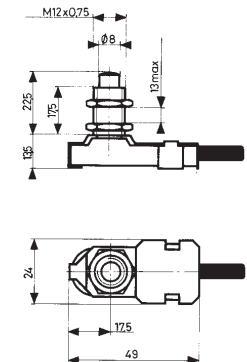

Other information

For other versions, functions and special contacts or special modes of operation : please consult us.

To order, specify :

1/2 meter cable	1 meter cable	2 meter cable
83731316	83731319	83731310
83732323	83732315	83732327
83733315	83733314	83733310

Standard products, non stocked

1 Type

Example : Limit switch - 83 731 319

Products and specifications subject to change without notice.

Order/Technical Support – Tel: (800) 677-5311 / FAX: (800) 677-3865 / www.crouzet-usa.com

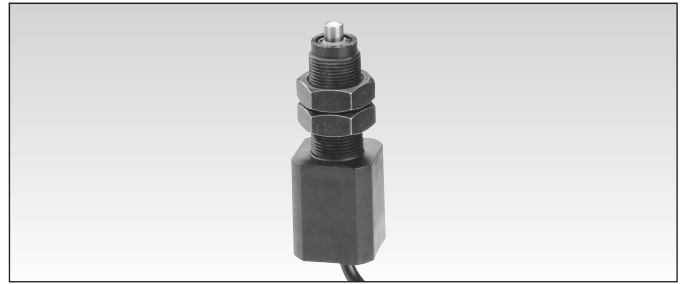

Conform to the following standards :

IEC 356.1 - NFC 20030 class I : plunger actuated via earthed metal part or an insulating device providing additional insulation.

Version :

1 pole

Degree of protection :

IP 66/67 Resistant to hydrocarbons and saline mist (400 hours).

Function :

Single break two-way contact element
(Form C : inverter).

Components :

Materials	Casing	: thermoplastic polyester
	Plunger	: stainless steel
	Contact	: Agcdo - AgNi (gold)
	Nuts	: galvanized steel
Sealing	Silicon and teflon seals	
	PU resin.	

Principle :



Electrical characteristics :

Standard : 8 A 250 V ~ : 30 000 operations
 200 mA 24 V = relay load L/R = 3 ms 10⁷ operations
 Two-level : 1 mA 4 V : 10⁷ operations
 200 mA 24 V = relay load L/R =
 3 ms 5 x 10⁶ operations
 5 A 250 V ~ : 30,000 operations

The two-level type is designed to operate both on two-level (1 mA 4 V minimum) and medium current (5 A maximum) circuits.
 However, a given product can only switch a single type of circuit throughout its life.

Connections :

3 x 0.75 mm² PVC cables. 0.50 m long
 Conforms to NFR 13414/13415.

Core connections :

1 = black (common)
 2 = gray (NC)
 4 = blue (NO)

Mounting :

Max. tightening torque : 9 Nm.

Types

Standard	83 589 0	1
Two-level	83 589 8	

Control mechanism

Top-mounted plunger	•	•
---------------------	---	---

Function

Form C (SPDT)	C	C
----------------------	----------	----------

Mechanical characteristics

Minimum operating force	N (oz.)	10 (35.5)	10 (35.5)
Minimum total travel force	N (oz.)	15 (53)	15 (53)
Minimum operating travel	mm (in.)	2 (0.08)	2 (0.08)
Differential travel	mm (in.)	0.1 (.004)	0.1 (.004)
Max. total travel	mm (in.)	4.5 (.177)	4.5 (.177)
Mechanical life*	Operations	10 ⁷	10 ⁷
Temperature limits	°C (°F)	-40+85(-40+185)	-40+85(-40+185)
Degree of protection		IP 66 / 67	IP 66 / 67
Weight	g (oz.)	80	80

* For operating travel of 4 mm.

Dimensions

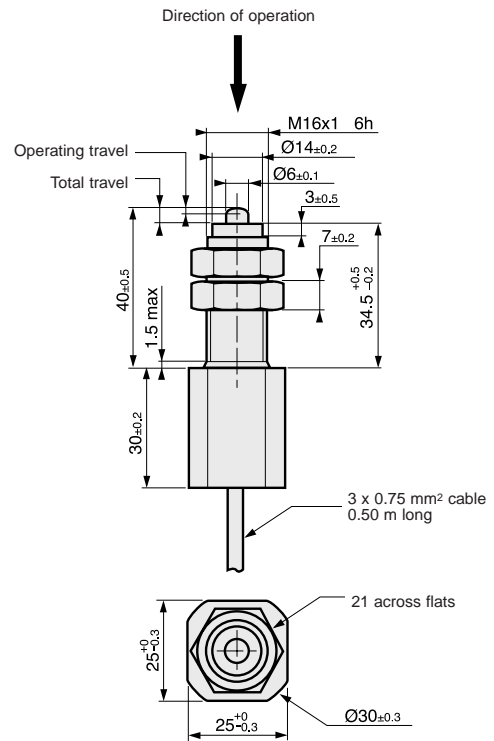

Other information	To order, specify :			
For other versions, functions and special contacts or special modes of operation : please consult us.	83589 series			
	1.) Model	2.) Contact Configuration	3.) Output	4.) Length
	835890	A (SPNO)	W (Wires)	0.5 (1/2 meter)
	835898	B (SPNC)	C (Cable)	1.0 (1 meter)
		C (SPDT)		2.0 (2 meter)

Products and specifications subject to change without notice.

Order/Technical Support – Tel: (800) 677-5311 / FAX: (800) 677-3865 / www.crouzet-usa.com

Sealed Limit Switches Telescopic-Actuator Series 83 581

Conforms to the following standards : NFC 20030 class II - NFC 20010

Degree of protection : IP 67

Contact type : Three terminal single break contact element (Form C: SPDT)

Layout :



Electrical characteristics :

Assigned working currents (Ie): standard 10 A - 250 V~
low current 0.1 A - 250 V~

Electrical endurance :

Standard : 10 A - 250 V : 40 000 operations
5 A - 250 V : 100 000 operations

Low current : Designed for use from 1 to 100 mA at 4 to 30 volts.
In these conditions, the electrical endurance exceeds the mechanical life.

Connections :

Flexible leads 3x1 mm². Length 0.50 m
Cable 3x0,75 mm². Length 0.50 m
Core connections: 1: black
2: brown
4: blue

Versions

Features

Standard _____

Low current _____

Operating devices

Telescopic top-mounted plunger _____

Plunger with axial roller - standard _____

Plunger roller at 90° (G 90) - Consult Factory

Contact Type

Form C – SPDT

Mechanical characteristics

Minimum operating force _____ N (oz)

Minimum total travel force _____ N (oz)

Movement differential _____ mm (in)

Minimum operating travel _____ mm (in)

Total travel max. _____ mm (in)

Mechanical life _____ Operations

Temperature limits _____ °C (°F)

Degree of protection _____

Weight _____ g (oz)

Connections

Flexible leads _____ Lead position - right (D) _____

_____ Lead position - left (G) _____

Cable _____ Output on left _____

* Rating restricted to 8A

Dimensions

mm(in)

83 581 0

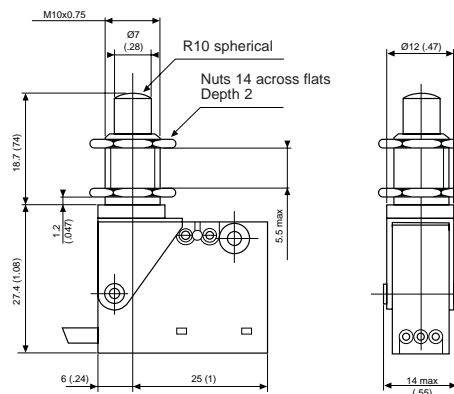

Other information

For other accessories and special contacts, or special modes of operation, please consult factory.

Products and specifications subject to change without notice.

Order/Technical Support – Tel: (800) 677-5311 / FAX: (800) 677-3865 / www.crouzet-usa.com



83 581 0		83 581 1	
S	B	S	B
C	C	C	C
5 (17.6)	5 (17.6)	5 (17.6)	5 (17.6)
20 (70.5)	20 (70.5)	20 (70.5)	20 (70.5)
1 (.04)	1 (.04)	1 (.04)	1 (.04)
2.5 (.1)	2.5 (.1)	2.5 (.1)	2.5 (.1)
5.5 (.22)	5.5 (.22)	5 (.2)	5 (.2)
10 ⁵	10 ⁵	10 ⁵	10 ⁵
-20 to 85 (-4 to 185)	-20 to 85 (-4 to 185)	-20 to 85 (-4 to 185)	-20 to 85 (-4 to 185)
IP 67	IP 67	IP 67	IP 67
40 (1.4)	40 (1.4)	45 (1.6)	45 (1.6)
R	R	R	R
L	L	L	L
C*	C	C*	C

83 581 1

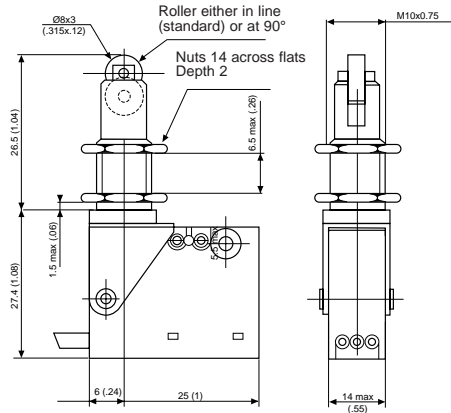

To order, please specify :

Example : 835810 S C C •

<p>1 Switch Type</p> <p>835810 835811</p>	<p>2 Current Level</p> <p>S - 10A B - <.1A</p>	<p>3 Contacts</p> <p>C</p>	<p>4 Outputs</p> <p>R - Right (flexible wires) L - Left (flexible wires) C - Cable left output only</p>	<p>5 Lead Length</p> <p>.5 - 1/2 meter 1 - 1 meter 2 - 2 meter</p>
--	--	-----------------------------------	--	---

Products and specifications subject to change without notice.

Order/Technical Support – Tel: (800) 677-5311 / FAX: (800) 677-3865 / www.crouzet-usa.com

General Specifications :

Operation

To defeat the switch
83 523 - 83 528. Depress the plunger and turn it a quarter of a turn.
To reset the switch to rest position depress the plunger.

Components

Bracket
Zinc plated mild steel
Plunger
Stainless steel
Switch
83 523, 83 106 0, 83 528, 83 132, 83 133

Layout

83 523 - 83 528



Current Ratings

83 523 - 10 Amps
83 528 - 5 Amps
Other current ratings are available

For low current applications, gold contacts are available

Approvals: Please consult us.

Types

Features

Operating force min.	N (oz)
Movement differential	mm (in)
Total travel max.	mm (in)
Tripping point min.	mm (in)
Mechanical life	Operations
Weight	grams (oz)
Operating temperature	°C (°F)

Contact Configuration - SPDT

Connections

Screw
Solder (.110 " Quick connect also for 83 528)
1/14" Quick connects
3/16" Quick connects

Other information

Standard products normally stocked
 Catalog products, produced to order

Products and specifications subject to change without notice.

Order/Technical Support – Tel: (800) 677-5311 / FAX: (800) 677-3865 / www.crouzet-usa.com

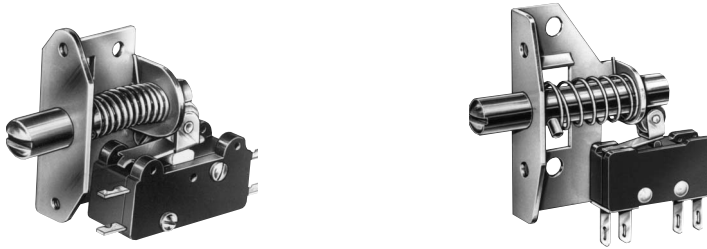

83 523 0		83 523 3		83 528 0		83 528 3	
1 Pole		2 Poles		1 Pole		2 Poles	
30 (105)	30 (105)	6 (21.1)	8 (28.1)	6 (21.1)	8 (28.1)	6 (21.1)	8 (28.1)
1 (.04)	1 (.04)	.7 (.027)	.7 (.027)	.7 (.027)	.7 (.027)	.7 (.027)	.7 (.027)
6 (.24)	6 (.24)	6 (.24)	6 (.24)	6 (.24)	6 (.24)	6 (.24)	6 (.24)
4 (.16)	4 (.16)	2.5 (.10)	2.5 (.10)	2.5 (.10)	2.5 (.10)	2.5 (.10)	2.5 (.10)
10 ⁷	10 ⁷	10 ⁷	10 ⁷	10 ⁷	10 ⁷	10 ⁷	10 ⁷
40 (1.41)	55 (1.94)	20 (.70)	23 (.81)	20 (.70)	23 (.81)	20 (.70)	23 (.81)

C	C	C	C
1	1	N/A	N/A
2	2	2	2
3	3	N/A	N/A
N/A	N/A	N/A	N/A

Dimensions

83 523

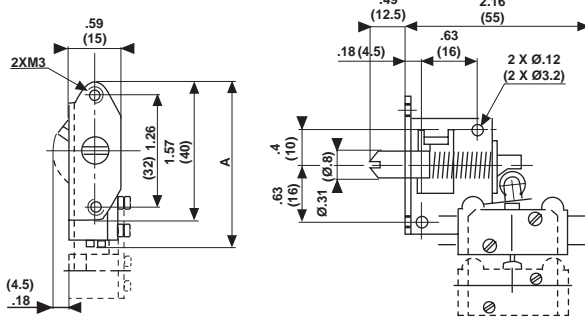

83 528

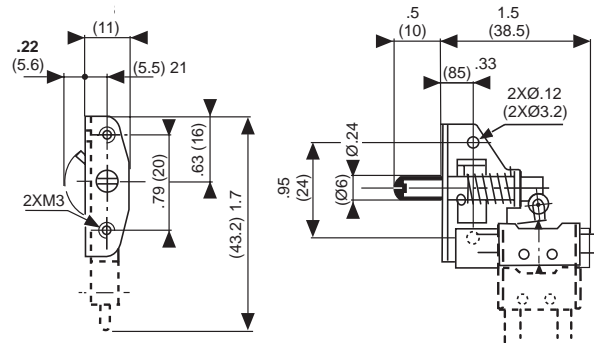

mm (in)

To order, please specify:

Example : **835280** C 2 • DL

1 Switch Type	2 Configuration	3 Connections
85 523 0	C*	1
83 523 3		2
83 528 0		3
83 528 3		

Products and specifications subject to change without notice.

Order/Technical Support – Tel: (800) 677-5311 / FAX: (800) 677-3865 / www.crouzet-usa.com

Conform to the following standards :

IEC 536-1, IEC 947-5-1, CSA C22.2 N°14
 EN 50047, EN 60204-1, EN 60947-5-1
 NFC 20030 class II for 83 854
 class I for 83 855
 UL 508, VDE 0660/200

Degree of protection : IP 66

Function : Four-terminal double break contact element (form Zb) with positive opening NC contacts.
 The two moving contacts are electrically isolated from one another.

Principle :

Dependent action contact (1 NC + 1 NO)
 Break before make

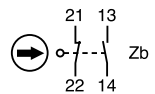

After actuation, the safety contact remains locked open in position "NC". It is unlocked by pressing the reset button.

Electrical characteristics :

Assigned insulation voltage (Ui) : 500 V
 Thermal rating (Ith) : 10 A
 Use category : A300 - Q300
 AC15 = 6A/250 V - 1.9 A / 380 V
 DC 13 = 3A/24 V

Short circuit test (under IEC 947.5.1 § 8.3.4)

- Current peak 1000 A at 250 V ~ 0.5 <math><math>\cos \varphi < 0.7</math></math>
- Short circuit protection (SCPD) : fuse 10 A gF
- Electrical protection by internal earth terminal (83 850)

Connections :

Saddle washer and M 3.5 screw
 Max. wire cross-section : 2 x 1.5 mm² or 1 x 2.5 mm²

Connection :

For No. 13 sealing gland

Approvals :

Slow break NC + NO version
 UL / CSA : please consult us.

Part number

Thermoplastic case	Ø 22
and metal head	Ø 50
Metal bodies and	Ø 22
actuator heads	Ø 50
Special option - configuration EN 50047	
Control mechanisms - adjustable actuator heads 4 positions 90°	
Steel plunger	
Plunger with steel roller	
Lever with plastic roller	vertical
	lateral
Rotary head, momentary action to right and left (1)	
With lever and plastic roller	Ø 19 offset 21 or 53
	Ø 22 offset 33.5 or 40
	Ø 50 offset 47
	Ø 50 offset 53.5
With adjustable lever and plastic roller	Ø 22 offset 32.5 or 45
	Ø 50 offset 46
	Ø 50 adjustable offset 53.5 to 69.5

Sequence

Dependent action

Positive break operation

Mechanical characteristics

Minimum operating force	N - (cmN)
Minimum total travel force	N - (cmN)
Minimum positive operating force	N - (cmN)
Minimum operating travel	mm - (°)
Minimum positive opening travel	mm - (°)
Differential travel	mm - (°)
Max. total travel	mm - (°)
Mechanical life	10 ⁶ operations min.
Temperature limits	Use ° C
	Stored ° C
Degree of protection	
Weight (plastic/metal)	g

(1) Action either right or left according to position of head

Dimensions

83 856 011 - 83 857 011

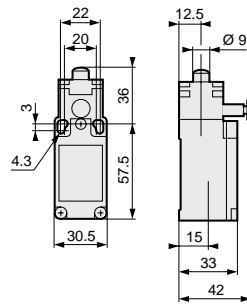

83 856 511 - 83 857 511

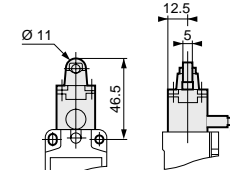

83 856 311 - 82 857 311

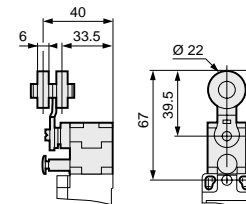

Other information

To order, specify :

Standard products	1 Part number
Standard products, non stocked	Example : Limit switch with manual reset - 83 857 011

Products and specifications subject to change without notice.

Order/Technical Support – Tel: (800) 677-5311 / FAX: (800) 677-3865 / www.crouzet-usa.com



1

83 857 011	83 857 511	83 857 111	83 857 211	83 857 311 (Ø22)	83 857 312 (Ø19)	83 857 313 (Ø22)	83 857 318 (Ø50)
83 856 011	83 856 511	83 856 111	83 856 211	83 857 315 (Ø50)	83 857 316 (Ø50)	83 857 317 (Ø50)	83 857 318 (Ø50)
				83 856 311 (Ø22)	83 856 312 (Ø19)	83 856 313 (Ø22)	83 856 318 (Ø50)
				83 856 315 (Ø50)	83 856 316 (Ø50)	83 856 317 (Ø50)	83 856 318 (Ø50)

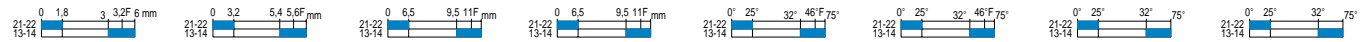
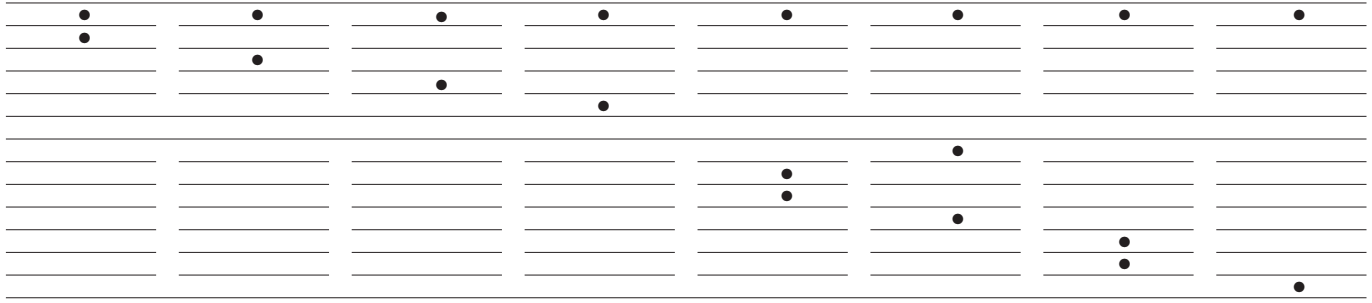

10	9	9	9	(28)	(28)	(28)	(28)
12	10	10	10	(37)	(37)	(37)	(37)
2.5	2.5	20	20	(75)	(75)	(75)	(75)
5	5	5	5	(30)	(30)	(30)	(30)
3.2	5.6	11	11	(46)	(46)	(46)	(46)
1.5	1.5	1.5	1.5	(20)	(20)	(20)	(20)
6	6	6	6	(75)	(75)	(75)	(75)
1	1	1	1	1	1	1	1
-20 +80	-20 +80	-20 +80	-20 +80	-20 +80	-20 +80	-20 +80	-20 +80
-40 +80	-40 +80	-40 +80	-40 +80	-40 +80	-40 +80	-40 +80	-40 +80
IP 66	IP 66	IP 66	IP 66	IP 66	IP 66	IP 66	IP 66
145/230	155/240	150/240	150/240	190/270	190/270	210/300	230/320

83 856 111 / 211 - 83 857 111 / 211

83 856 313 - 83 857 313

83 856 318 - 83 857 318

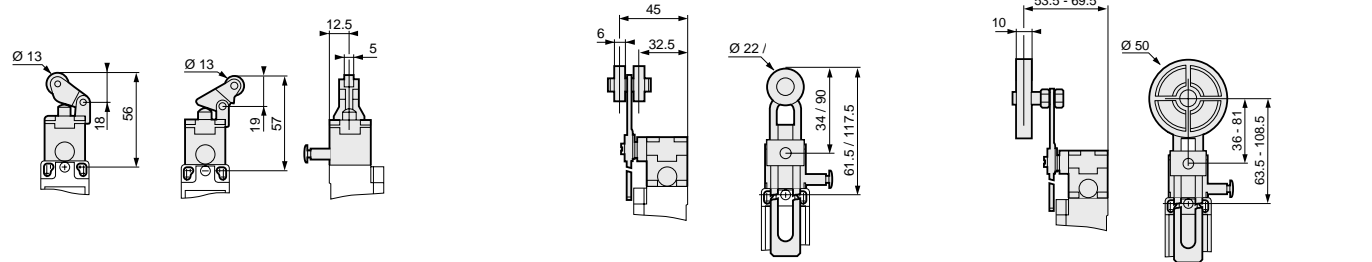

83 856 312 - 83 857 312

83 856 315 - 83 857 315

83 856 316 - 83 857 316

83 856 317 - 83 857 317

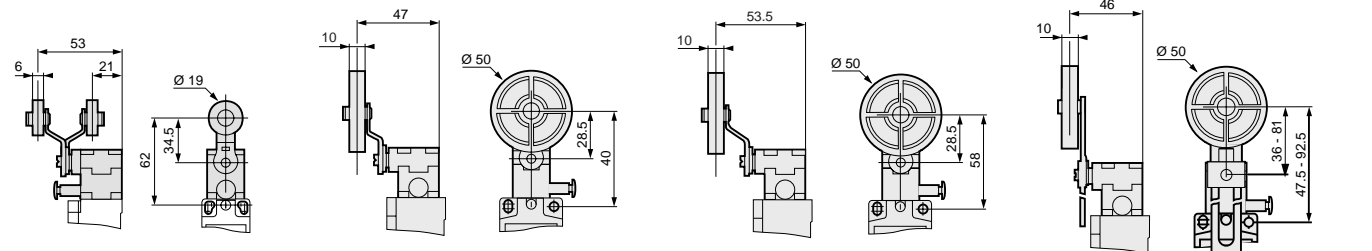

Products and specifications subject to change without notice.

Order/Technical Support – Tel: (800) 677-5311 / FAX: (800) 677-3865 / www.crouzet-usa.com



Hermetically Sealed Limit Switches

Hermetically sealed microswitch

Part # 83 151 001
Without accessories
(basic cell -55° +150°C)

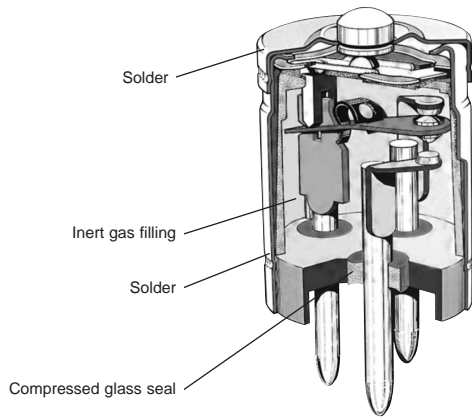

Characteristics

Min. current	5 V \equiv	mA	1
Nominal current			
Resistive	48 V \equiv ⁽¹⁾	A	3
Lamp	115 V - 400 Hz	A	1
Lamp	30 V \equiv ⁽¹⁾	A	2
Resistive	30 V \equiv ⁽¹⁾	A	3
Inductive L/R = 0.005 s	30 V \equiv ⁽¹⁾	A	1.5
Resistive	220 V \sim	A	1
Inductive - cos ϕ 0.8	220 V \sim	A	0.4
Service life at nominal current ⁽³⁾ - operations		min	200,000
Dielectric strength between connections and ground		V	1200
Rigidity between connections		V	1000
Insulation resistance (at 500 Vdc)		M	100
Voltage drop at 1 A ⁽²⁾		V	0.02
Operating temperature		°C	-55 +150
Resistance to shock ⁽²⁾		g/ms	200/11
Resistance to vibration ⁽³⁾		g/Hz	80/20 \rightarrow 2000

(1) For a service life of 100,000 operations - Permissible current 4A inductive 7 A resistive for normally open or normally closed.

(2) On soldered connections - For wired connections add 0.1 V per metre.

(3) Value for microswitch without control button

Connections (consult factory)

Wired (0.38 mm² - 0.50 m long)

Soldered

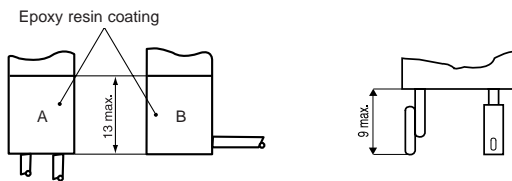

A - Parallel to the axis (//)
B - Perpendicular to the axis (\perp)



Dimensions

Add the dimensions of the various connections for the total dimensions (\rightarrow indicates the direction of the wires)

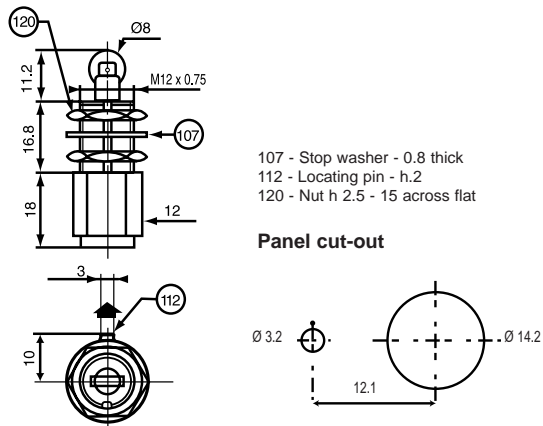

Part numbers

Wire 0.38 mm ²	with parallel wires	83 770 025
0.50 m long	perpendicular	83 770 035
With single-pole roller plunger		•

Characteristics

Max operating force	N	12
Min. release force	N	1.5
Permitted overtravel force	N	50
Positive overtravel stop		•
Max. pre-travel	mm	0.3
Max. differential travel	mm	0.05
Min. overtravel	mm	3
Resistance to shocks	g/ms	100/11
Resistance to vibrations	g/Hz	50/800 \rightarrow 2000
Weight (without wires)	g	20
Service life (operations - min)		100,000

To order, specify :

Standard products, non stocked

1 Part number

Example : Hermetically sealed limit switch - 83 770 025

Products and specifications subject to change without notice.

Order/Technical Support – Tel: (800) 677-5311 / FAX: (800) 677-3865 / www.crouzet-usa.com



Waterproof Limit Switches Series 83 141

Standard sensitive microswitch

83 141 002 - (55 °C +150 °C)
Without accessories



Connections

Solder tags

Characteristics

Nominal current	10 V \equiv	A	0.01
Resistive	30 V \equiv	A	4
	220 V \sim	A	1
Inductive L/R = 0.005 s	30 V \equiv	A	2
	220 V \sim	A	0.5
Service life at nominal current ⁽¹⁾ - operations			100,000
Operating temperature		°C	-55 +150
Max. operating force		N	2
Min. release force		N	0.4
Max. pre-travel		mm	0.5
Max. differential travel		mm	0.08
Min. overtravel		mm	0.1
Weight		g	1

⁽¹⁾ Value for microswitch without control button

- 107 - Stop washer width 0.8
- 112 - Locating pin
- 117 - Free position
- 118 - Nuts h. 2.5 - 15 across flat
- 120 - Nuts h. 2.5 and 6 - 15 across flat
- 121 - Nuts h. 3 and 6 - 21 across flat
- 122 - Roller Ø 9.6 - width 3
- 130 - Pin h.2

83 777 021

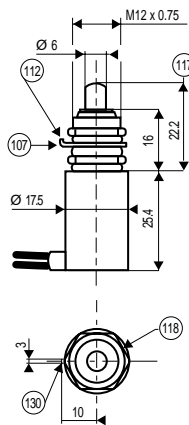

83 778 021

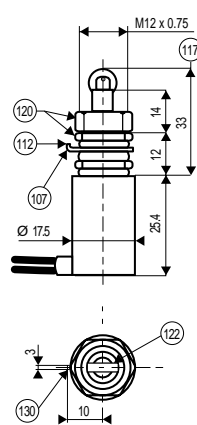

Panel cut-out

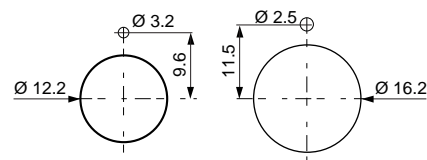

Dimensions – mm



Part numbers

	83 777 021	83 778 021
1 pole		
With plunger	•	
With plunger and roller		•
Output with perpendicular wires	•	•

Characteristics

Max. operating force	N	60	60
Min. release force	N	10	10
Max. total travel force	N	150	150
Max. pre-travel	mm	1.2	1.2
Max. differential travel	mm	0.2	0.2
Min. overtravel	mm	3.2	3.2
Weight (with wires)	g	30	37

General characteristics

Nominal current	10 V \equiv	A	0.01
Resistive	30 V \equiv	A	4
	220 V \sim	A	1
Inductive L/R = 0.005 s	30 V \equiv	A	2
	220 V \sim	A	0.5
Service life at nominal current (min. operations)			50,000
Dielectric strength between connections and ground	V		1500
Dielectric strength between connections	V		1000
Insulation resistance (at 500 Vdc)	M		100
Voltage drop at 1 A*	V		0.06
Operating temperature	°C		-55 +125
Resistance to shock	g/ms		50/11
Resistance to vibration	g/Hz		10/20 → 2000

* For flying leads, add 0.1 V/metre.

To order, specify :

Standard products, non stocked

1 Part number

Example : Waterproof limit switch - 83 777 021

Products and specifications subject to change without notice.

Order/Technical Support – Tel: (800) 677-5311 / FAX: (800) 677-3865 / www.crouzet-usa.com

Cable Pull Limit Switches Series 83 863 / 83 864

Conforms to the following standards:

EN 50041 - IEC 947.5.1 - VDE 0660/2
 UL 468 - UL 508 - CSA C22.2 No14
 NFC class 1 - EN 418 - Machine Directive 89/392/CEE

Degree of Protection : IP 66

Function : Four separate terminals with two separate NC switching elements with positive opening contacts. One set works in the cable break mode and the other works in the cable pull mode.

Both elements are electrically isolated from one another.

Layout :

Cable attached with tension Cable Pull Mode Cable Break Mode

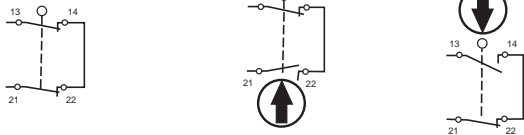

Electrical characteristics :

Assigned insulation voltage (Ui) : 500V
 Thermal rating (Ith) : 10 A
 Use category : A300 - Q300
 AC15 = 6A/250V - 1.9 A/380V
 DC13 = 3A/24V

Short circuit test (under IEC 947.5.1 sec. 8.3.4)

- Current peak 100 A at 250V $\sqrt{0.5 < \cos < 0.7}$
- Short circuit protection (SCPD) : fuse 10 A gF
- Electrical protection by internal earth ground

Connections :

Saddle washer and M3.5 screw
 Max. wire cross section : 2 x 1.5 mm² or 1 x 2.5 mm²

Connection :

For No 13 or 1/2" NPT sealing gland

Approvals :

Pending

Typical Mounting:

The cable is to be tightened until the head is extended with the slot below the E-ring visible. This sets the switch.

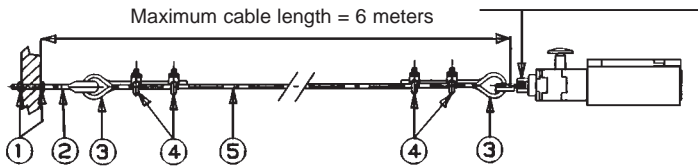

1. Lock Nut
2. Eyelet Bolt
3. Cable through eyelet bolt.
4. Cable clamps
5. Cable - red PVC (red is international color for safety)



Part Numbers

Metric No 13	83863001
1/2" NPT	83864001

Mechanical Characteristics:

Minimum Operating Force	cmN	85
Minimum Operating Distance	mm	4
Movement Differential	mm	2
Maximum Total Travel	mm	8
Mechanical Life	operations	3x10 ⁷
Operating Temperature	C°	-25 to +70
Storage Temperature	C°	-40 to +70

Mounting Characteristics :

Maximum Length of Cable	meters	6
-------------------------	--------	---

Dimensions :

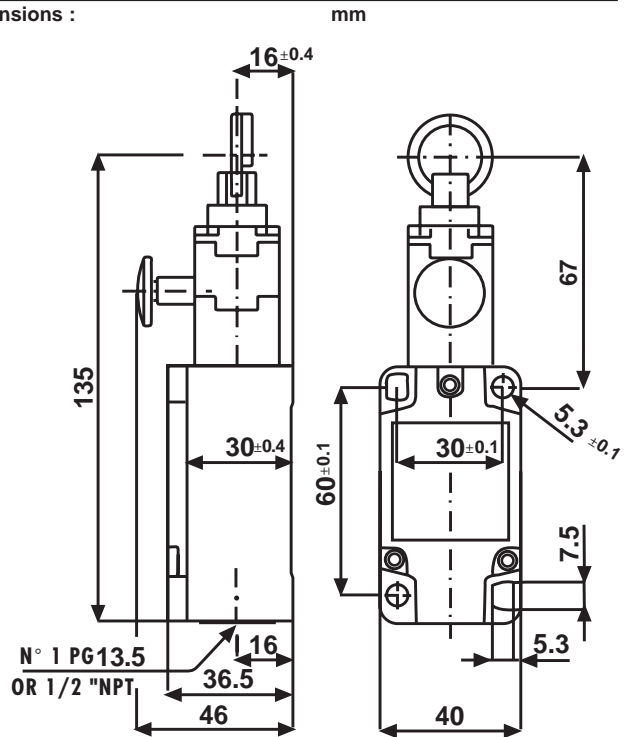

Standard products available in-stock in normal quantities

Catalog products produced to order

Products and specifications subject to change without notice.

Order/Technical Support – Tel: (800) 677-5311 / FAX: (800) 677-3865 / www.crouzet-usa.com

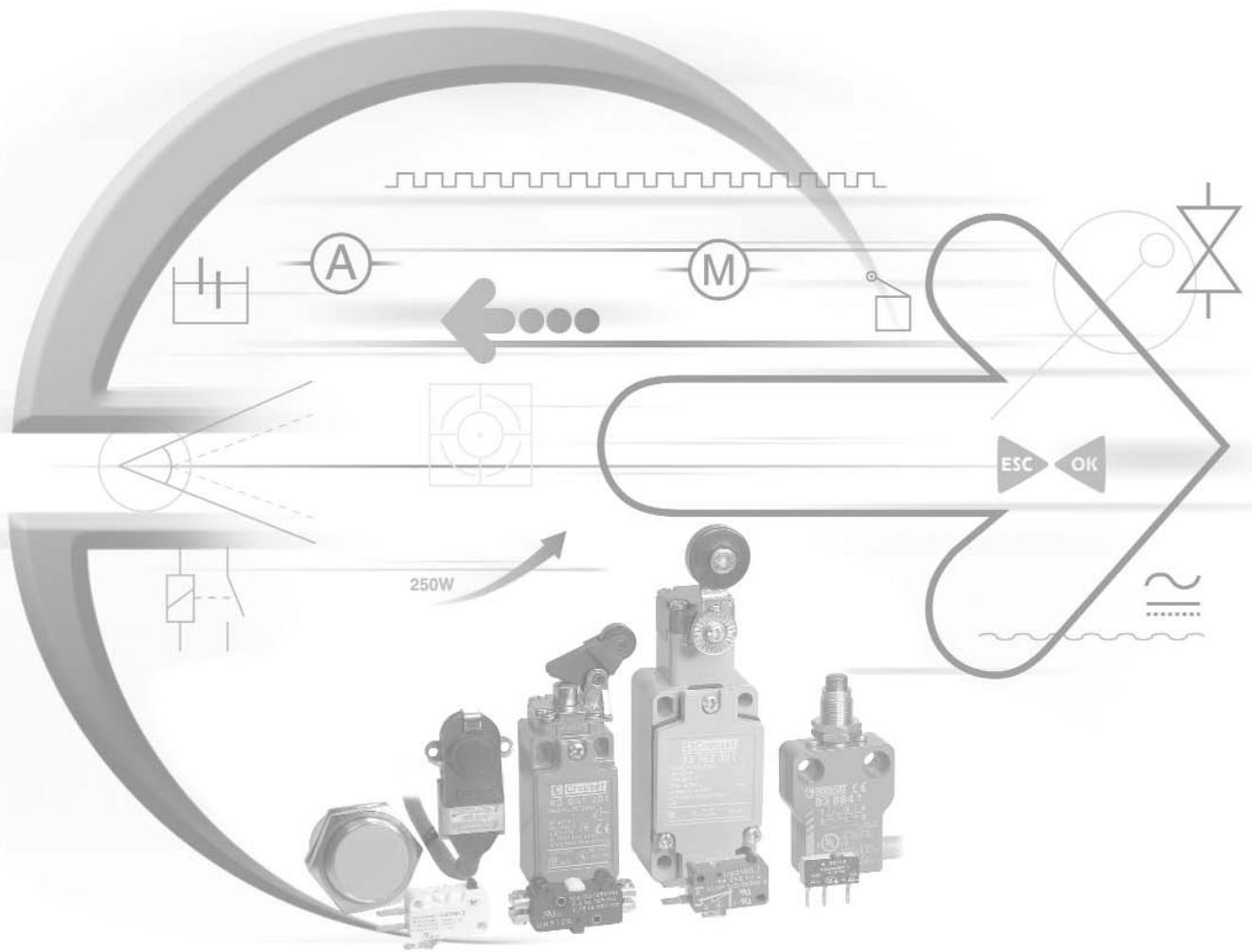

Safety (Security) Limit Switches



Products and specifications subject to change without notice.

Order/Technical Support – Tel: (800) 677-5311 / FAX: (800) 677-3865 / www.crouzet-usa.com

Miniature Plastic Key Lock Limit Switches Series 83 893 0 / 83 893 1 IP 67

- Key-operated safety interlock switches for monitoring the moving cover
- Plastic bodies and heads
- Heads have 4 possible positions
- Positive opening contacts

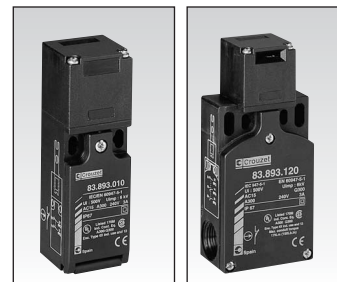

General characteristics

Environment

Conforming to standards	Products	IEC 947-5-1, EN 60 947-5-1, UL 508, CSA C22-2 no.14, JIS C4520 (See P. 2/2 and 2/3)
	Machine assemblies	IEC 204-1, EN 60 204-1, EN 1088, EN 292
Certifications		UL, CSA
Protective treatment		In normal operation: "TC"
Temperature	Use	-25°C, +70°C
	Stored	-40°C, +70°C
Vibration resistance		5 gn (10...500 Hz) according to IEC 68-2-6
Shock resistance		10 gn (duration 11 ms) according to IEC 28-2-27
Degree of protection		IP 67 according to IEC 529 and IEC 947-5-1
Cable entry		Cable gland 11

Electrical characteristics

Assigned working characteristics	AC 15 A 300 Ue = 240 V, Ie = 3A or Ue = 120 V, Ie = 6 A DC 13 Q 300 Ue = 250 V, Ie = 0.27 A or Ue = 125 V, Ie = 0.55 A
Assigned insulation voltage	Ui = 500 V according to IEC 947-5-1 Ui = 300 V according to UL 508, CSA C22-2 no. 14
Assigned impulse voltage	Uimp = 6 KV acc. to IEC 947-5-1
Thermal rating	Ithe = 10 A according to IEC 947-5-1
Electric shock protection	Class 2 according to IEC 536
Resistance between terminals	30 m according to IEC 954-5-4
Short-circuit protection	Cartridge fuse 10 A gG (gl)
Connection	Screw clamp terminals Clamping capacity min. 1 x 0.5 mm ² , max. 1.5 mm ² with or without ferrule
Electrical life	According to IEC 947-5-1 appendix C

Part numbers





Type of contact

NC+NO	2-pole contact NC+NO break before make, slow action	83 893 001
NC+NC	2-pole contact NC+NC, slow action	83 893 010
NC+NO+NO	3-pole contact NC+NO+NO (2 NO bbm) + slow action	83 893 120
NC+NC+NO	3-pole contact NC+NC+NO (NO bbm) + slow action	83 893 130

Additional characteristics

Maximum actuation speed	0.5 m/s	0.5 m/s
Minimum actuation speed	0.01 m/s	0.01 m/s
Resistance to removal of key	10 N	10 N
Mechanical life	1 million operating cycles	1 million operating cycles
Maximum operating frequency	600 operating cycles per hour	600 operating cycles per hour
Minimum positive opening force	15 N	15 N
Pg 11 cable entry according to NFC 68 300	1	2
Thermal rating (Ith)	10 A	10 A
Assigned insulation voltage (Ui)	500 V	500 V
Weight	0.110 kg	0.160 kg

Accessories

Straight key		79 214 581
Key with wide fixing bar		79 214 582
Short key with wide fixing bar		79 214 585
Angled key		79 214 584
Flexible key		79 214 583

To order, specify:

Standard products

1

Part number

Example: Safety limit switch 83 893 001 - Straight key 79 214 581

2

Accessory

Standard products, non stocked

2

Accessory

Example: Straight key 79 214 581

Products and specifications subject to change without notice.

Order/Technical Support – Tel: (800) 677-5311 / FAX: (800) 677-3865 / www.crouzet-usa.com

Dimensions

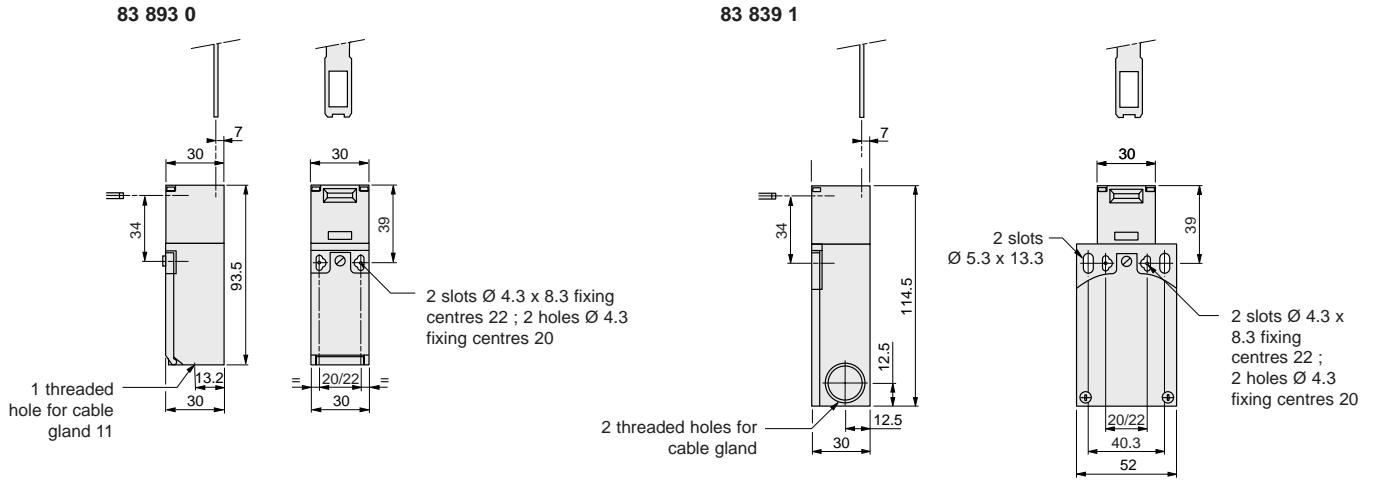

Accessories

79 214 581

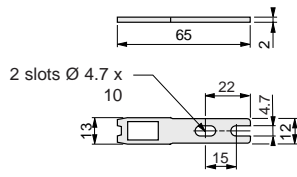

79 214 582 / 585

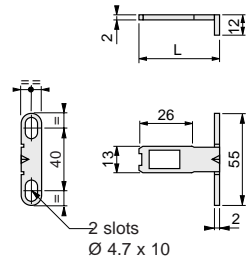

Types	Dimension L (mm)
79 214 582	40
79 214 585	29

79 214 584

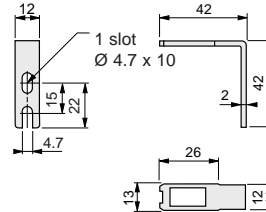

79 214 583

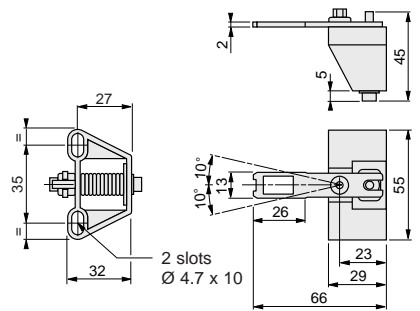

Operating radius

79 214 581

79 214 582 / 585

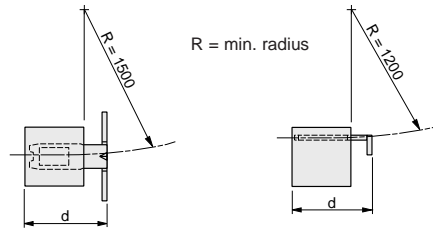
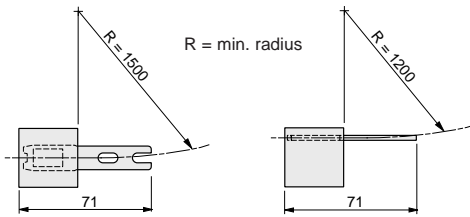

Types	Dimension d (mm)
79 214 582	46
79 214 585	35

79 214 584

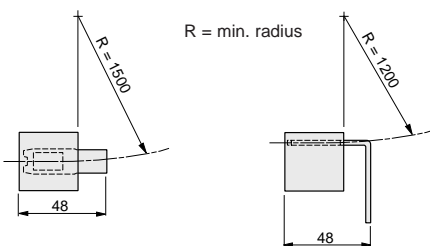

79 214 583

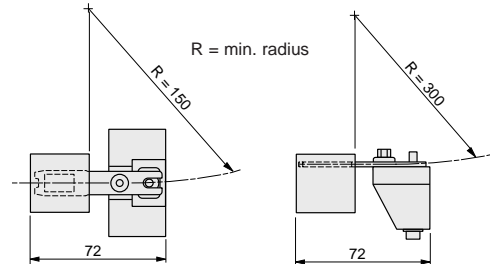

Other information

Products and specifications subject to change without notice.

Order/Technical Support – Tel: (800) 677-5311 / FAX: (800) 677-3865 / www.crouzet-usa.com

Solenoid Operated Plastic Key Lock Limit Switches Series 83 893 2 IP 67

- Monitoring of the moving cover for machines with a stopping time which is greater than the time taken to access the danger zone
- Locked by removing the voltage, unlocked by applying voltage to the electromagnet
- Plastic bodies and heads
- Heads have 4 possible positions
- Positive opening contacts

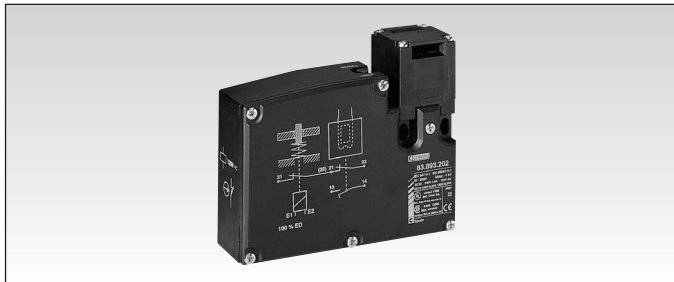

General characteristics

Environment

Conforming to standards	Products	IEC 947-5-1, EN 60 947-5-1, UL 508, CSA C22-2 no. 14, JIS C4520
	Machine assemblies	IEC 204-1, EN 60 204-1, EN 1088, EN 292
Certifications		UL, CSA
Protective treatment		In normal operation: "TC"
Temperature	Use	-25°C, +70°C
	Stored	-40°C, +70°C
Vibration resistance		5 gn (10...500 Hz) according to IEC 68-2-6
Shock resistance		10 gn (duration 11 ms) according to IEC 28-2-27
Degree of protection		IP 67 according to IEC 529 and IEC 947-5-1
Cable entry		One entry per cable gland 11

Electrical characteristics

Assigned working characteristics	AC 15 B300 Ue = 240 V, Ie = 1.5 A or Ue = 120 V, Ie = 3 A DC 13 Q300 Ue = 250 V, Ie = 0.27 A or Ue = 125 V, Ie = 0.55 A
Assigned insulation voltage	Ui = 500 V according to IEC 947-5-1 Ui = 300 V according to UL 508, CSA C22-2 no. 14
Assigned impulse voltage	Uimp = 4 KV acc. to IEC 947-5-1
Thermal rating	Ithe = 6 A according to IEC 947-5-1
Electric shock protection	Class 2 according to IEC 536
Resistance between terminals	3 0 m according to IEC 954-5-4
Short-circuit protection	Cartridge fuse 10 A gG (gl)
Connection	Screw clamp terminals Clamping capacity min. 1 x 0.5 mm ² , max. 1.5 mm ² with or without ferrule
Electrical life	According to IEC 947-5-1 appendix C

Part numbers

Type of contact

NC+NO	2-pole contact NC+NO break before make, slow action	83 893 201	83 893 202	83 893 203
-------	---	-------------------	-------------------	-------------------

Additional characteristics

Electromagnet supply voltage (50/60 Hz in ~)	24 V ~/~/ 120 V ~/~/ 230 V ~/~/
Maximum actuation speed	0.5 m/s
Minimum actuation speed	0.01 m/s
Resistance to removal of key	500 N
Mechanical life	1 million operating cycles
Maximum operating frequency	600 operating cycles per hour
Minimum positive opening force	15 N
Pg 11 cable entry according to NFC 68 300	1
Weight	0.360 kg

Accessories

Straight key		79 214 581
Key with wide fixing bar		79 214 582
Short key with wide fixing bar		79 214 585
Angled key		79 214 584
Flexible key		79 214 583

To order, specify:

Standard products

1 Part number **2** Accessory
Example: Safety limit switch 83 893 201 - Angled key 79 214 584

Standard products, non stocked

1 Part number **2** Accessory
Example: Safety limit switch 83 893 203 - Straight key 79 214 581

Products and specifications subject to change without notice.

Order/Technical Support – Tel: (800) 677-5311 / FAX: (800) 677-3865 / www.crouzet-usa.com

Locking / unlocking using an electromagnet

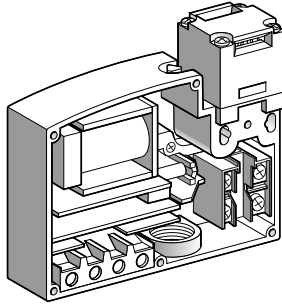

Type 83 893 2 safety switches are fitted with an electromagnet for locking/unlocking the guard.

With the guard locked, the force required to remove the key is 50 daN.

In addition to the 2-pole contact element actuated by the key, type 83 893 2 limit switches also have a positive break type "NC" contact element, actuated by the electromagnet.

The "NC" contact is integrated in the machine safety circuit.

Unlocking using a special tool

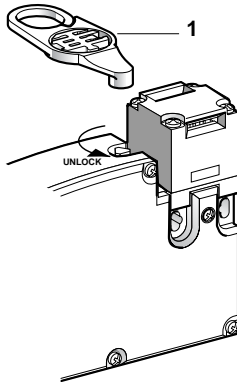

Type 83 893 2 safety switches are supplied with a tool (1) which can be used to unlock the moving guard, bypassing the electromagnet.

Unlocking using a tool is recommended in the following cases:

- machine maintenance (if the tool is in the "UNLOCK" position and then removed, this will prevent the machine from restarting accidentally, therefore ensuring the safety of maintenance personnel),
- mains failure,
- problem with unlocking (locking cannot be released: fail-safe condition).

Unlocking by applying voltage to the electromagnet always takes priority over unlocking using a tool. The "NC" contact is integrated in the machine safety circuit.

Power supply for the electromagnet on 83 893 2

The electromagnet for type 83 893 2 safety switches is supplied by an electronic circuit which increases its service life. As the 24 V version is protected by a bridge rectifier, an A.C. or D.C. supply can be used.

The 120 V and 230 V versions are A.C. only. It is also protected against voltage surges.

Dimensions

83 893 2

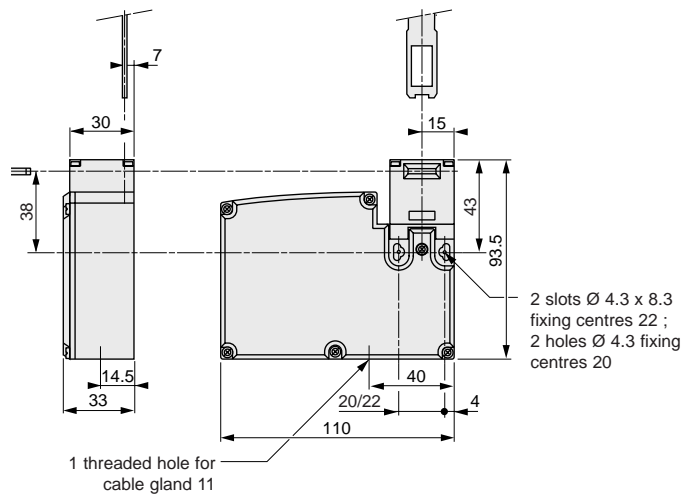

Category 1 connection according to EN 954-1

Examples of wiring diagrams with a fuse to provide protection against short-circuits in the cable or tampering.

Locking by removal of voltage 83 893 2

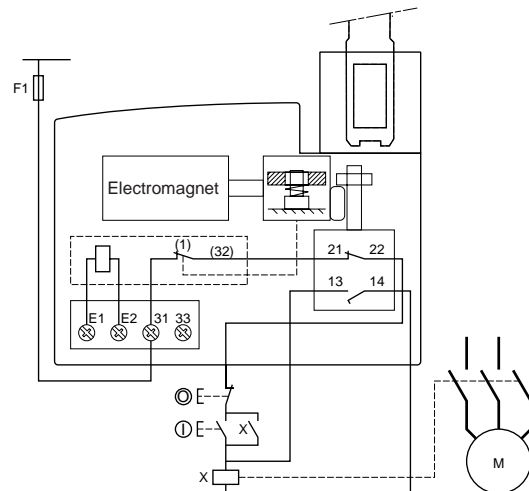

- (1) Auxiliary contact
E1-E2: Power supply for electromagnet
13-14: Safety contact for redundancy or signalling

Other information

For accessory dimensions, see page 2/5.

Products and specifications subject to change without notice.

Order/Technical Support – Tel: (800) 677-5311 / FAX: (800) 677-3865 / www.crouzet-usa.com

Industrial Metal Key Lock Limit Switches Series 83 894 0 IP 67

- Spade terminal safety interlock switch for monitoring the moving cover
- Metal bodies and heads
- Heads have 4 possible positions
- Positive opening contacts



General characteristics

Environment

Conforming to standards	Products	IEC 947-5-1, EN 60 947-5-1, UL 508, CSA C22-2 no.14, JIS C4520
	Machine assemblies	IEC 204-1, EN 60 204-1, EN 1088, EN 292
Certifications		UL, CSA
Protective treatment		In normal operation: "TC"
Temperature	Use	-25°C, +70°C
	Stored	-40°C, +70°C
Vibration resistance		5 gn (10...500 Hz) according to IEC 68-2-6
Shock resistance		10 gn (duration 11 ms) according to IEC 28-2-27
Degree of protection		IP 67 according to IEC 529 and IEC 947-5-1
Cable entry		One threaded entry for cable gland 13

Electrical characteristics

Assigned working characteristics	AC 15 A 300 Ue = 240 V, Ie = 3 A or Ue = 120 V, Ie = 6 A DC 13 Q 300 Ue = 250 V, Ie = 0.27 A or Ue = 125 V, Ie = 0.55 A
Assigned insulation voltage	Ui = 500 V according to IEC 947-5-1 Ui = 300 V according to UL 508, CSA C22-2 no.14
Assigned impulse voltage	Uimp = 6 KV according to IEC 947-5-1
Thermal rating	Ithe = 10 A according to IEC 947-5-1
Electric shock protection	Class 2 according to IEC 536
Resistance between terminals	3 0 m according to IEC 954-5-4
Short-circuit protection	Cartridge fuse 10 A gG (gl)
Connection	Screw clamp terminals Clamping capacity min. 1 x 0.5 mm ² , max. 1.5 mm ² with or without ferrule
Electrical life	According to IEC 947-5-1 appendix C

Part numbers



Type of contact

NC+NO+NO	3-pole contact	83 894 020
	NC+NO+NO (2 NO btm) slow action	

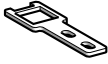

Additional characteristics

Maximum actuation speed	0.5 m/s
Minimum actuation speed	0.01 m/s
Resistance to removal of key	10 N
Mechanical life	> 1 million operating cycles
Maximum operating frequency	600 operating cycles per hour
Minimum positive opening force	20 N
Cable entry (DIN Pg 13.5 cable gland 13) according to NFC 68 300	1
Weight	0.360 kg

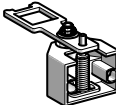
Accessories

Straight key		79 214 578
Key with wide fixing bar		79 214 579
Flexible key		79 214 580

To order, specify:

 Standard products	1 Part number Example: Safety limit switch 83 894 020 - Wide key 79 214 579	2 Accessory
 Standard products, non stocked	2 Accessory Example: Flexible key 79 214 580	

Products and specifications subject to change without notice.

Order/Technical Support – Tel: (800) 677-5311 / FAX: (800) 677-3865 / www.crouzet-usa.com

Dimensions mm
83 893 0

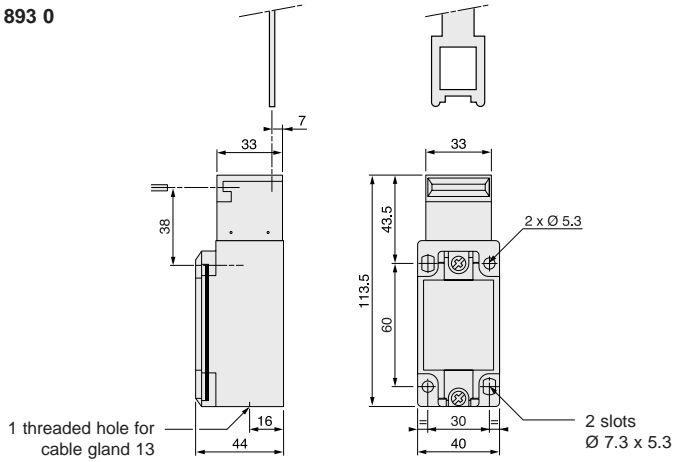

Accessories

79 214 579

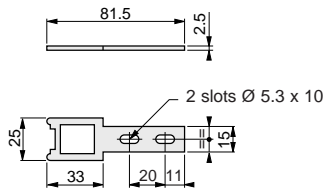

79 214 578

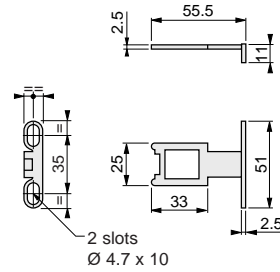

79 214 580

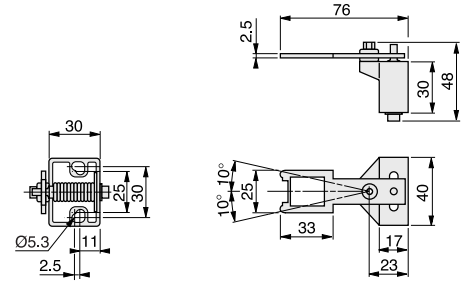

Operating radius

79 214 578

79 214 579

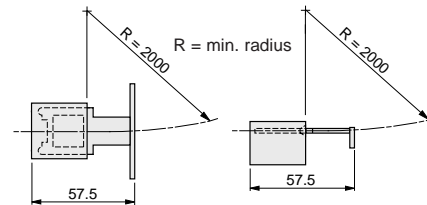
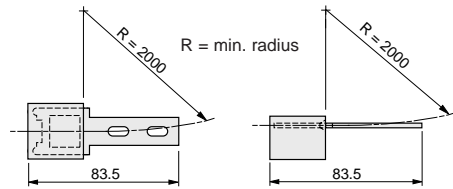

79 214 580

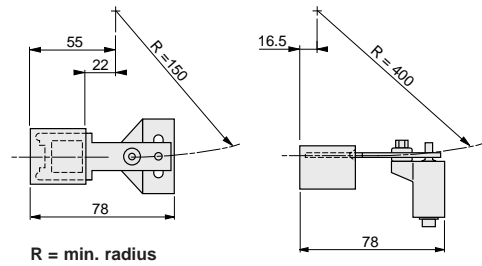

Other information

Products and specifications subject to change without notice.

Order/Technical Support – Tel: (800) 677-5311 / FAX: (800) 677-3865 / www.crouzet-usa.com

Solenoid Operated Metal Key Lock Limit Switches Series 83 894 1

- Monitoring of the moving cover for machines with a stopping time which is greater than the time taken to access the danger zone
- Locked by removing the voltage, unlocked by applying voltage to the electromagnet
- Metal bodies and heads
- Heads have 4 possible positions
- Positive opening contacts

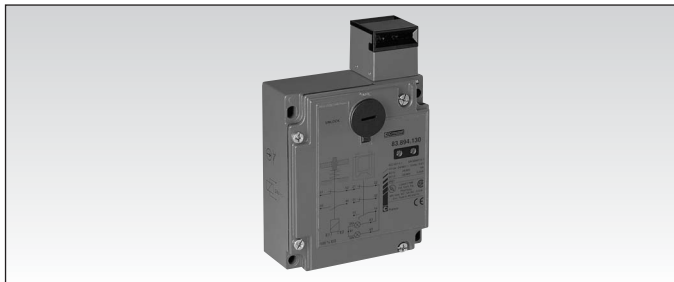

General characteristics

Environment

Conforming to standards	Products	IEC 947-5-1, EN 60 947-5-1, UL 508, CSA C22-2 no.14, JIS C4520 (See P. 3/14)
	Machine assemblies	IEC 204-1, EN 60 204-1, EN 1088, EN 292
Certifications		UL, CSA
Protective treatment		In normal operation: "TC"
Temperature	Use	-25°C, +70°C
	Stored	-40°C, +70°C
Vibration resistance		5 gn (10...500 Hz) according to IEC 68-2-6
Shock resistance		10 gn (duration 11 ms) according to IEC 28-2-27
Degree of protection		IP 67 according to IEC 529 and IEC 947-5-1
Cable entry		Threaded entry for cable gland 13

Electrical characteristics

Assigned working characteristics	AC 15 B300 Ue = 240 V, Ie = 1.5 A or Ue = 120 V, Ie = 3 A DC 13 Q300 Ue = 250 V, Ie = 0.27 A or Ue = 125 V, Ie = 0.55 A
Assigned insulation voltage	Ui = 500 V according to IEC 947-5-1 Ui = 300 V according to UL 508, CSA C22-2 no. 14
Assigned impulse voltage	Uimp = 4 KV according to IEC 947-5-1
Thermal rating	Ithe = 6 A according to IEC 947-5-1
Electric shock protection	Class 2 according to IEC 536
Resistance between terminals	3 0 m according to IEC 954-5-4
Short-circuit protection	Cartridge fuse 10 A gG (gl)
Connection	Screw clamp terminals Clamping capacity min. 1 x 0.5 mm ² , max. 1.5 mm ² with or without ferrule
Electrical life	According to IEC 947-5-1 appendix C

Dimensions mm

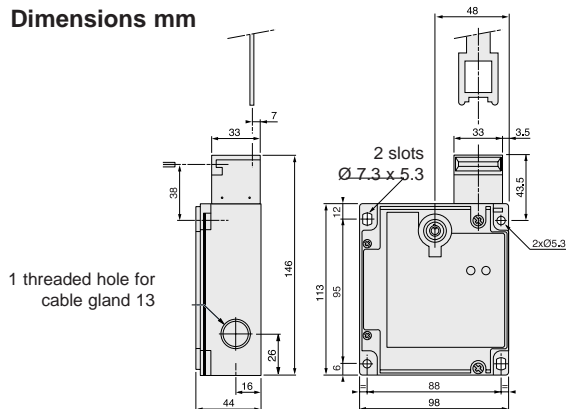

Part numbers

Type of contact

NC+NO+NO 3-pole contact NC+NO+NO (2 NO bbm) + slow action	83 894 120	83 894 121	83 894 122
NC+NC+NO 3-pole contact NC+NC+NO (NO bbm) slow action	83 894 130	83 894 131	83 894 132

Additional characteristics

Electromagnet supply voltage (50 / 60 Hz in ~)	24 V ~/∞ 120 V ~/∞ 230 V ~/∞
Maximum actuation speed	0.5 m/s
Minimum actuation speed	0.01 m/s
Resistance to removal of key	2000 N
Mechanical life	> 1 million operating cycles
Maximum operating frequency	600 operating cycles per hour
Minimum positive opening force	20 N
Cable entries Pg 13 according to NFC 68 300	2
Weight	1.140 kg



Electromagnet characteristics

Load factor	100%
Voltage limits	-20% ; +10 %
Service life	20,000 hours
Consumption	Inrush 10 VA Sealed 10 VA

Indicator characteristics

Assigned insulation voltage according to IEC 947-5-1	50 V	250 V	250 V
Current consumption	7 mA	7 mA	7 mA
Assigned working voltage ~ or ∞	24 V	110 / 240 V	110 / 240 V
Voltage limits ~ or ∞ (including ripple)	20...52 V	95...264 V	95...264 V
Service life	100,000 hrs	100,000 hrs	100,000 hrs
Protection against voltage surges	yes	yes	yes

Accessories

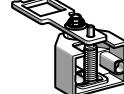
Straight key		79 214 578
Wide key		79 214 579
Flexible key		79 214 580

To order, specify:

Standard products **1** Part number
Example: Safety limit switch 83 894 120 - Wide key 79 214 579

Standard products, non stocked **1** Part number **2** Accessory
Example: Safety limit switch 83 894 132 - Straight key 79 214 578

Products and specifications subject to change without notice.

Order/Technical Support – Tel: (800) 677-5311 / FAX: (800) 677-3865 / www.crouzet-usa.com

Locking / unlocking using an electromagnet

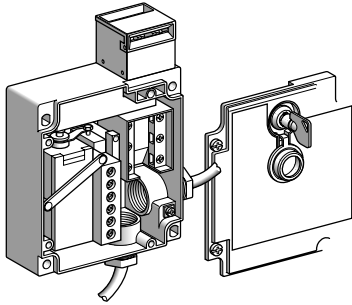

Type 83 894 1 safety switches are fitted with an electromagnet for locking/unlocking the guard.

With the guard locked, the force required to remove the key is **200 daN**.

In addition to the 3-pole contact element actuated by the key, 83 894 1 limit switches also have a positive break type **“NC + NO” contact element, actuated by the electromagnet**. The NC contact is integrated in the machine safety circuit, and the NO contact indicates the position of the electromagnet.

Locking using a key on 83 894 1

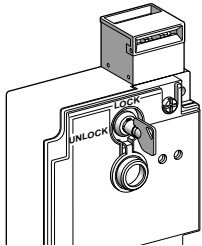

Type 83 894 1 safety switches are supplied with a key-operated lock which can be used to unlock the moving guard, bypassing the electromagnet.

Unlocking using a key-operated lock is recommended in the following cases :

- machine maintenance (if the key is turned to “UNLOCK” and then removed, this will prevent the machine from restarting accidentally, therefore ensuring the safety of maintenance personnel),
 - mains failure,
 - problem with unlocking (locking cannot be released: fail-safe condition).
- Unlocking by applying voltage to the electromagnet always takes priority over unlocking using a key-operated lock.

The locking mechanism for standard devices allows the key to be removed in the “LOCK” and “UNLOCK” positions.

Power supply for the electromagnet on 83 894 1

The electromagnet for type 83 894 1 safety switches runs on D.C. and is therefore particularly reliable.

As it is protected by a **bridge rectifier**, A.C or D.C supplies can be used (24 V, 48 V, 120 V or 230 V).

It is also protected against voltage surges.

Connections

Category 1 according to EN 954-1

Examples of wiring diagrams with a fuse to provide protection against short-circuits in the cable or tampering.

Locking by removal of voltage “NC+NO+NO” 83 894 12 •

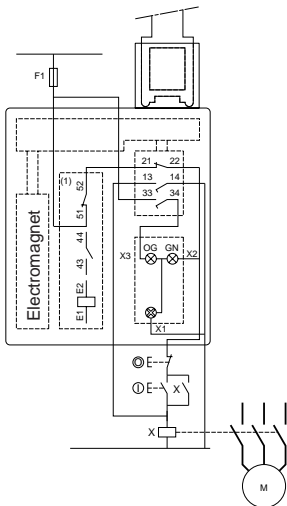

- (1) Auxiliary contact
 E1-E2: Power supply for electromagnet
 43-44: Electromagnet signal contact
 13-14: Safety contact available for redundancy

Category 3 according to EN 954-1

Examples of wiring diagrams with redundancy of the switch contacts, without monitoring.

Locking by removal of voltage “NC+NC+NO” 83 894 13 •

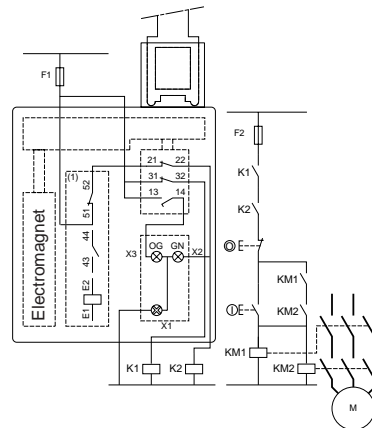

- 33-X1: LED (orange): key not inserted
 51-X1: LED (green): key inserted and locked
 21-52: Safety pre-wiring compulsory

Other information

For accessory dimensions, see page 2/9.

Products and specifications subject to change without notice.

Order/Technical Support – Tel: (800) 677-5311 / FAX: (800) 677-3865 / www.crouzet-usa.com

Hinged Limit Switches Series 83 893 IP 67

- Door hinge safety switches for monitoring the cover, or rotating housing on small machinery
- Plastic bodies and heads
- Stainless steel lever and fixing accessories
- Heads have 4 possible positions
- Positive opening contacts

General characteristics

Environment

Conforming to standards	Products	IEC 947-5-1, EN 60 947-5-1, UL 508, CSA C22-2 no. 14, JIS C4520 (See P. 2/2 and 2/3)
	Machine assemblies	IEC 204-1, EN 60 204-1, EN 1088, EN 292
Certifications		UL, CSA
Protective treatment		In normal operation: "TC" and "TH"
Temperature	Use	-25°C, +70°C
	Stored	-40°C, +70°C
Vibration resistance		25 gn (10...500 Hz) according to IEC 68-2-6
Shock resistance		11 gn (duration 11 ms) according to IEC 28-2-27
Degree of protection		IP 67 according to IEC 529 and IEC 947-5-1
Cable entry		One threaded entry for cable gland 11

Electrical characteristics

Assigned working characteristics	AC 15 A 300 Ue = 240 V, Ie = 3A DC 13 Q 300 Ue = 250 V, Ie = 0.27 A
Assigned insulation voltage	Ui = 500 V according to IEC 947-5-1 Ui = 300 V according to UL 508, CSA C22-2 no. 14
Assigned impulse voltage	Uimp = 6 KV according to IEC 947-5-1
Thermal rating	Ithe = 10 A according to IEC 947-5-1
Electric shock protection	Class 2 according to IEC 536
Resistance between terminals	3 0 m according to IEC 954-5-4
Short-circuit protection	Cartridge fuse 10 A gG (gl)
Connection	Screw clamp terminals Clamping capacity min. 1 x 0.5 mm ² , max. 1.5 mm ² with or without ferrule
Electrical life	According to IEC 947-5-1 appendix C
Minimum actuation speed	0.01 m/s

Part numbers

Position of lever

Type of contact

NC+NO 2-pole contact NC+NO break before make, slow action

Additional characteristics

Tripping angle
Minimum actuation torque
Minimum positive opening torque
Mechanical life
Pg11 cable entry according to NFC 68 300
Weight

Operation

Lever movement

83 893 301 / 303

83 893 302

83 893 401

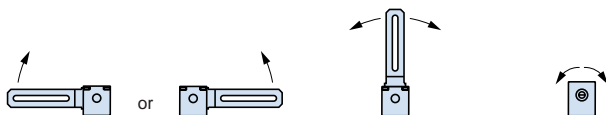

Operating diagrams

83 893 301 / 303

83 893 302

83 893 401

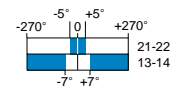
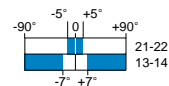
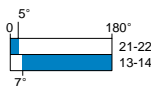

Operation of contacts

■ closed

□ open

To order, specify:

Standard products

1

Part number

Example: Safety limit switch 83 893 302

Products and specifications subject to change without notice.

Order/Technical Support – Tel: (800) 677-5311 / FAX: (800) 677-3865 / www.crouzet-usa.com

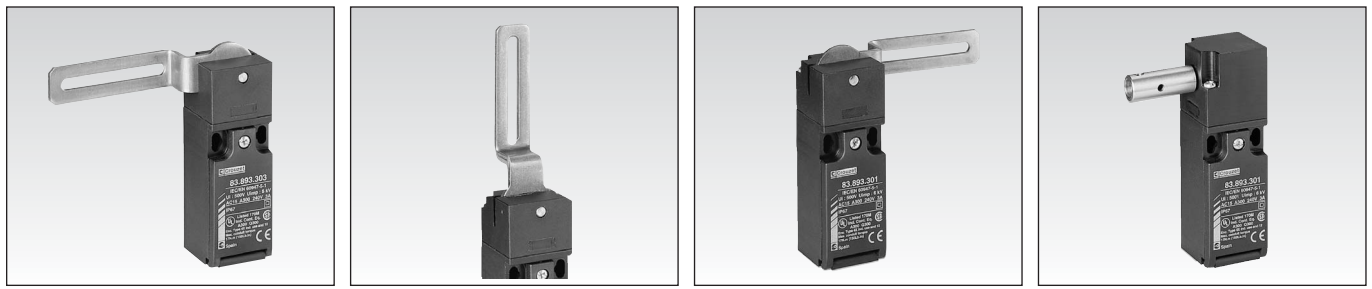

1

Left	Centre	Right	Length 30 mm
83 893 303	83 893 302	83 893 301	83 893 401
5°	5°	5°	5°
0.1 Nm	0.1 Nm	0.1 Nm	0.1 Nm
0.25 Nm	0.25 Nm	0.25 Nm	0.25 Nm
1 million operating cycles	1 million operating cycles	1 million operating cycles	1 million operating cycles
1	1	1	1
0.145 kg	0.145 kg	0.145 kg	0.145 kg

Dimensions

83 893 3

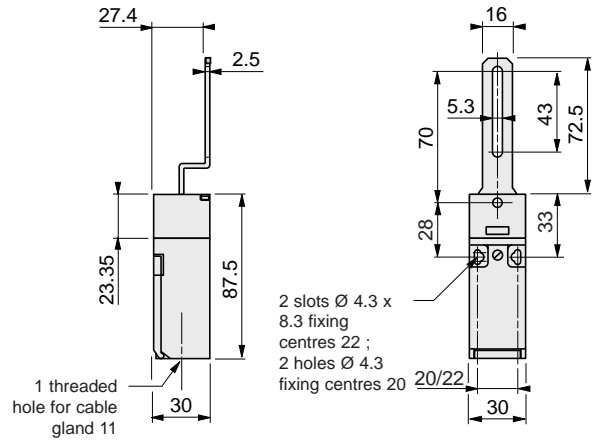

83 893 401

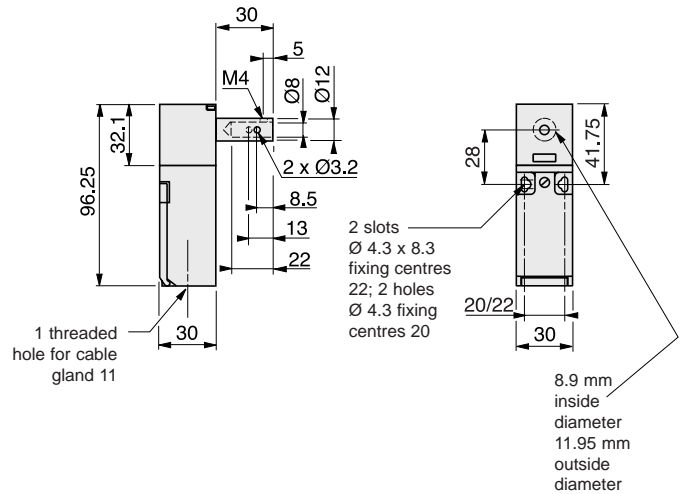

3

Other information

Products and specifications subject to change without notice.

Order/Technical Support – Tel: (800) 677-5311 / FAX: (800) 677-3865 / www.crouzet-usa.com

Cable Pull Limit Switches Series 83 894 2 IP 67

- “Emergency stop” safety switches are essential in areas or on machinery where a danger exists during operation
- The cable can be used to request an emergency stop at any point in the operating zone
- Applications : conveying, materials handling, machine tools
- Length of the protected zone: up to 15 metres



General characteristics

Environment

Conforming to standards	Products	IEC 947-5-1, EN 60 947-5-1, VDE 0660-200, EN 418, draft EN 616
	Machine assemblies	EN 60 204-1, EN 292 machinery directive: 89/392/EEC and 91/368/EEC, social directive: 89655/EEC
Certifications		UL, CSA
Protective treatment		"TC"
Temperature	Use	-25°C, +70°C
	Stored	-40°C, +70°C
Vibration resistance		10 gn (10...150 Hz)
Shock resistance		50 gn (duration 11 ms) according to IEC 28-2-27
Degree of protection		IP 65 according to IEC 529 and IEC 947-5-1
Mechanical life		100,000 operating cycles
Length of protected zone		15 m
Cable entry		3 entries for cable gland with a maximum capacity of 12 mm

Electrical characteristics

Assigned working characteristics	AC 15 A300 Ue = 240 V, Ie = 3 A DC 13 Q300 Ue = 250 V, Ie = 0.27 A
Assigned insulation voltage	Ui = 500 V degree of pollution 3 according to IEC 947-5-1 Ui = 300 V according to UL 508, CSA C22-2 no. 14
Assigned impulse voltage	Uimp = 6 KV according to IEC 947-5-1
Thermal rating	Ithe = 10 A
Electric shock protection	Class 1 according to IEC 536 and NF C 20-030
Resistance between terminals	3 5 m according to IEC 954-5-4
Short-circuit protection	Cartridge fuse 10 A gG (gl)
Terminal labelling	According to CENELEC EN 50013

Part numbers

Type of contact

NC+NO	2-pole contact	83 894 201
	NC+NO, slow action	

Additional characteristics

Distance between the cable supports	5 m
Manual reset	Using booted pushbutton
Cable anchor	Right or left
Weight	0.865 kg

Mounting accessories

Fixed cable support	79 214 571
---------------------	-------------------



Pulley support	79 214 577
----------------	-------------------

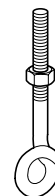

Pulley for cable max. Ø 5 mm	79 214 576
------------------------------	-------------------



End guards	79 214 572
------------	-------------------





Mounting kit

Mounting kit for cable, length 10 m	79 214 573
-------------------------------------	-------------------

Mounting kit for cable, length 15 m	79 214 574
-------------------------------------	-------------------

Kit comprising: a galvanised cable, Ø 3.2 mm in accordance with the length selected, 1 cable lug, 1 end spring

To order, specify:

 Standard products	1 Part number Example: Safety limit switch 83 894 201 - Pulley 79 214 576 - Kit 79 214 574	2 Accessory	3 Mounting kit
 Standard products, non stocked	2 Accessory Example: Pulley 79 214 576 - Kit 79 214 574	3 Mounting kit	

Products and specifications subject to change without notice.

Order/Technical Support – Tel: (800) 677-5311 / FAX: (800) 677-3865 / www.crouzet-usa.com

Installation

Description of a typical installation

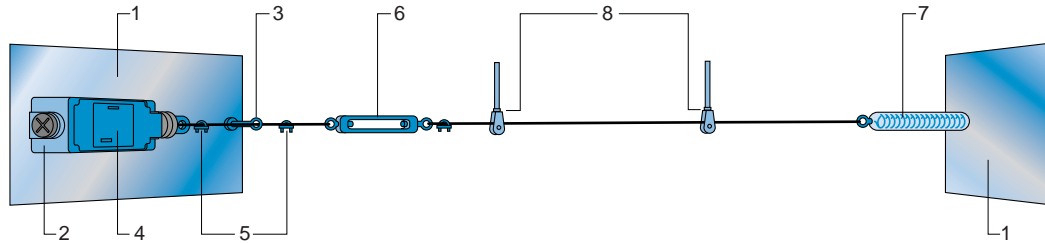

- 1 - Fixing support
- 2 - Emergency stop
- 3 - First cable support
- 4 - Device adjustment
- 5 - Faston connectors & cable clamps
- 6 - Turnbuckle
- 7 - End spring
- 8 - Pulleys and pulley supports

Pulleys must be used if the cable is ever installed with angles (example: perimeter of a machine).

Warning:

The sum total of the cable angles must be less than 180°.

Basic principles

Positive operation

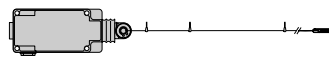

Device operating

Latching

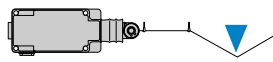

Device stopped

Reset

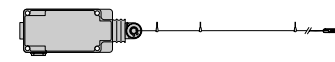

Device stopped (waiting)

Positive operation: The contacts used are positive break type contacts. The device is tripped by positive actuation.

Latching: The device is mechanically latched in the tripped position ("NC" safety contacts open). The "NO" contact is only used for signalling.

Reset: The devices have a reset button which closes the safety contact. The machine must only be started by deliberately pressing a start-up button, separate from the emergency stop.

Cable expansion: d

The cable may increase or reduce in length. Variations in length are mainly related to temperature variations on the site of use.

83 894 201 devices are fitted with cable voltage indicators which can be used to check (and correct if necessary) the voltage at any time.

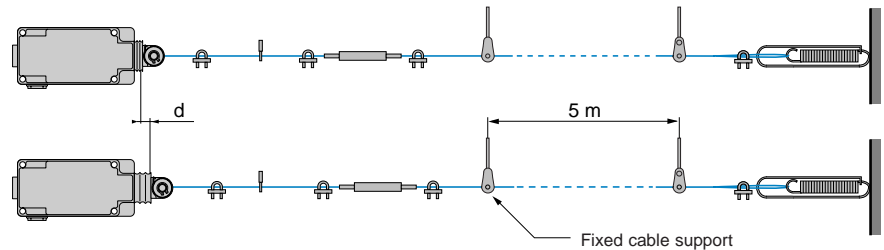

Actuating force and arrows

This is the value of the force **F1** exerted on the cable, causing the device to trip. **f** is the distance covered by the actuator at the bending point of the cable between the point of equilibrium during operation and the tripping point of the device.

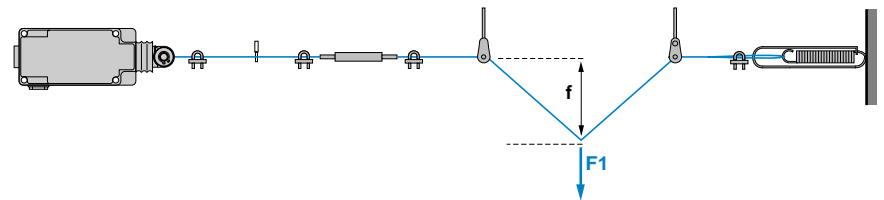

Operating values:

Average values of the tripping arrows and forces for 5 m fixing centres (standard force):

- Arrow **f**: 160 mm
- Arrow **F1**: 2 daN

Standards

83 894 201 devices meet the requirements of the harmonised European standard **EN 418** on "emergency stop devices". The strongly recommended use of an end spring meets the requirements of the draft European standard **EN 616** on "continuous materials handling systems and equipment".

Other information

Products and specifications subject to change without notice.

Order/Technical Support – Tel: (800) 677-5311 / FAX: (800) 677-3865 / www.crouzet-usa.com

Plastic or Metal Foot Switches Series 83 895 0 / 83 895 1

- Foot switch for machine tools, wood working machines, rubber and plastics machines, moulding presses
- Plastic foot switch:
without interlock at rest position
- Metal foot switch:
with interlock at rest position and protective cover

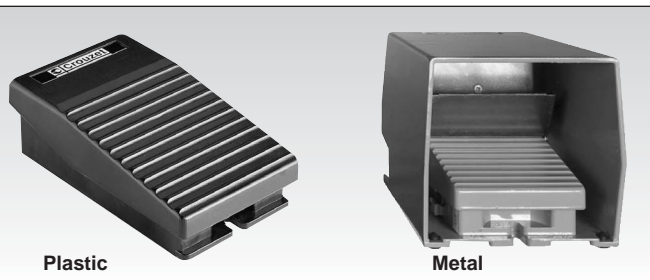

Plastic

Metal

General characteristics

Environment	Plastic	Metal
Conforming to standards	IEC 947-5-1, EN 60 947-5-1, VDE 0660-200, UL 508, CSA C22-2 no. 14	IEC 947-5-1, EN 60 947-5-1, VDE 0660-200, UL 508, CSA C22-2 no. 14 With protective cover: NFE 09-031
Certifications	FI	FI, CSA
Protective treatment	"TC"	
Temperature Use	-25°C, +70°C	
Temperature Stored	-40°C, +70°C	
Vibration resistance	15 gn (10...150 Hz)	
Shock resistance	25 gn acc. to IEC 68-2-27	20 gn acc. to IEC 68-2-27 (150 gn acc. to NF E 09-031)
Degree of protection	IP 43 acc. to IEC 529	IP 66 acc. to IEC 529
Mechanical life	2 million operations	5 million operations
Cable entry	2 untapped holes for cable gland	2 threaded holes for cable gland

Electrical characteristics

Assigned working characteristics	AC 15 A300 U _e = 240 V, I _e = 3 A DC 13 Q300 U _e = 250 V, I _e = 0.27 A
Assigned insulation voltage	U _i = 500 V, degree of pollution 3 according to IEC 947-5-1 U _i = 300 V according to UL 508, CSA C22-2 no. 14
Assigned impulse voltage	U _{imp} = 6 KV according to IEC 947-5-1
Electric shock protection	Class 2 acc. to IEC 536 and NF C 20-030 Class 1, acc. to IEC 536 and NF C 20-030
Resistance between terminals	030
Short-circuit protection	25 m according to IEC 954-5-4 Cartridge fuse 10 A gG (gl)

Part numbers

Type of contact	83 895 001	83 895 030	83 895 101
1 "NC+NO"			
2 "NC+NO"			
1 "NC+NO"			
Plastic	●	●	
Metal			●

Additional characteristics

Operating principle	1 step	2 steps	1 step
Operating frequency (maximum)	600 / hr	600 / hr	600 / hr
Weight	0.275 kg	0.295 kg	2.570 kg

To order, specify:

 Standard products	1 Part number Example: Plastic foot switch 83 895 001
 Standard products, non stocked	1 Part number Example: Metal foot switch 83 895 101

Products and specifications subject to change without notice.

Order/Technical Support – Tel: (800) 677-5311 / FAX: (800) 677-3865 / www.crouzet-usa.com

Presentation

83 895 0 and **83 895 101** foot switches are an ideal solution for controlling starting and stopping of numerous industrial machines with many different operating modes: pulsed, step-by-step, continuous.

The range comprises metal foot switches (for heavy loads where there is an increased risk) for heavy duty requirements, and plastic foot switches (for lighter loads where there is a reduced risk).

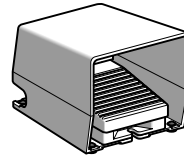

Fitted with a **protective cover**, metal foot switch **83 895 101** should be used whenever a start/stop command could pose a danger (**increased risk**).

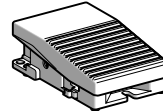

83 895 0 foot switches **without covers** are suitable for start commands which pose a **reduced risk** and for machine stop commands.

Terminology

Positive break operation

A device meets the requirements of this specification when all its normally closed contact elements can be safely set to their opening position.

All **foot switches** fitted with a snap action "NC+NO" contact element are positive break type and meet all the requirements of standard IEC 947-5-1, section 3.

Snap action contact

The linear speed of the moving contacts is independent of the speed of the control device. This feature enables high levels of electrical performance, even with low control device linear speeds.

Safety contacts

Devices with snap action positive break type contacts.

Metal foot switches can have one or two "NC + NO" contact blocks. These foot switches are in positive operation when released: positive actuation is required to maintain the machine in rest mode or cause it to stop (machine stop).

2-step pedals

Pedals with two steps are ideal for machines with two operating speeds.

Examples:

- first speed: slow (used for tool adjustment or maintenance),
- second speed: fast (used for normal machine operation).

The first step, connected to an "NC + NO" contact, is achieved by briefly applying gentle pressure to the foot switch (6 mm and 2 daN depression).

The second step, connected to a second "NC + NO" contact, is achieved by applying maximum pressure to the foot switch (12 mm and 9 daN for depression up to the end stop).

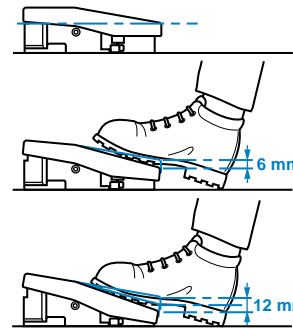

1st step

2nd step

Dimensions

83 895 101 with protective cover

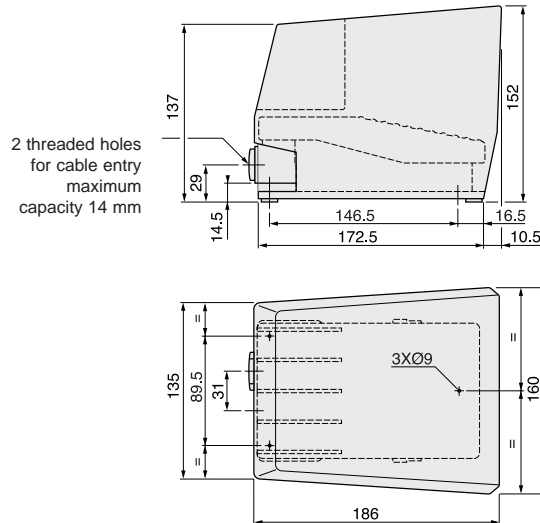

83 895 0

- 1 untapped hole for cable entry maximum capacity 12 mm
- 1 untapped hole for cable entry maximum capacity 8 mm

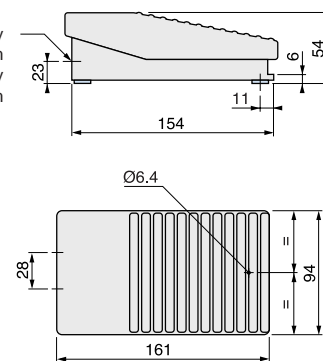

Other information

Products and specifications subject to change without notice.

Order/Technical Support – Tel: (800) 677-5311 / FAX: (800) 677-3865 / www.crouzet-usa.com

Emergency Stop Switches Series 79 697

- Ø 22 control unit with mechanical latch
- "CE" conforming product
- Positive opening contacts
- Pushbutton with positive mechanical action acc. to EN 418



Technical characteristics of contacts

Safety component	Positive opening contacts	
Certification	UL, CSA	
Mechanical life	3 x 10 ⁶ operations	
Electrical life	Operating category AC21 230 V/50 - 60Hz conforms to IEC 947-3	
	Working current	Number of operations
	(A)	(x 10 ⁶)
	14	0.2
	10	0.5
	6	1
	2	3
Insulation voltage	Degree of pollution 3-690 V conforms to UTE, VDE, IEC for flush-mounting	
Voltage for withstanding shocks	U impulse: 6 kV	
Electrical performance	A.C. Working voltage (50 -60 Hz)	Working current
		(IEC 947-3) (IEC 947-5-1)
	U _e (V)	AC21 AC15 I _e (A) I _e (A)
	230	14 6
	400	12 4.5
	440	11 3.5
	500	10 2.5
	690	6 1
	D.C. Working voltage	Working current
		(IEC 947-5-1) DC13
	U _e (V)	I _e (A)
	24 V	1.5 A
	48 V	1 A
	60 V	0.7 A
	110 V	0.3 A
	220 V	0.2 A
Protection against short-circuits	HPC fuse 10 A gl - gG conforms to IEC 269	
Temperature limits	Use	- 30 to + 60 °C
	Storage	- 50 to + 80 °C
Terminal capacity	2 x 2.5 mm ² with cable ends	
Connection	Via captive screw terminals	
Protection indices	Pushbutton	IP 65
	Box	IP 657 double insulation

Type

Mushroom head

Part numbers

1 "N/C" contact	79 697 003
1 "N/O" contact	79 697 004
Contact mounting bracket	79 697 005
Metal label, diameter 80, yellow	79 697 006
Push-pull head with 2 stable positions	79 697 008
Push-turn head with 2 stable positions	79 697 009
Locking head with key (supplied)	79 697 010
Mushroom head D = 70 black 1 "N/C + 1 "N/O"	79 697 101
Mushroom head D = 70 black	79 697 011

1

Symbol



Conformity

European "Machinery" Directive 89/392/EEC	•
French Decrees 92/765-766-767-768	•
European "Usage" Directive 89/655/EEC	•
French Decrees 93-40 and 93-41	•
European standard NF EN 60204-1 (Machine safety - Electrical equipment)	•
European standards NF EN 292-1 and 2 (Machine safety - Basic concepts)	•
European standard NF EN 418 (Machine safety - Emergency stop devices)	•

Dimensions

Cut-outs for consoles and cabinets

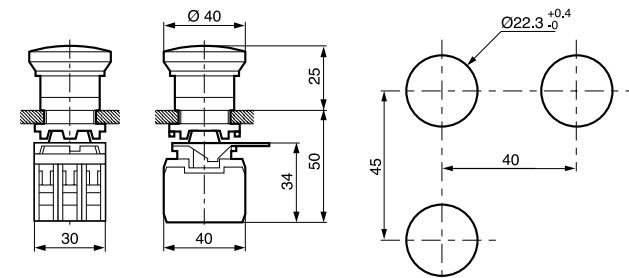

To order, specify:

Standard products

1 Part number

Example: Emergency stop pushbuttons for safety applications 79 697 003

Standard products, non stocked

Products and specifications subject to change without notice.

Order/Technical Support – Tel: (800) 677-5311 / FAX: (800) 677-3865 / www.crouzet-usa.com

Two-Hand Control Console Series 85 100

- Used in conjunction with a "KZH3" safety start module for two-hand control applications: folding, clipping, punching, rail-cutting, bending, drilling, presses, etc.
- Supplied with an emergency stop button and 2 spring-return mushroom head pushbuttons.
- Conforms to EN 574 concerning safety applications

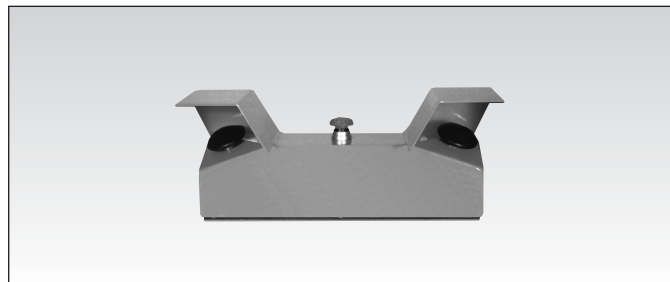

Part numbers

KSP2 two-hand control console (metal case)	85 100 291
KSP2 two-hand control console (plastic case)	85 100 293
KSP console fixing foot	85 100 292

Can be ordered separately

Mushroom head	Push-pull 2 "N/C" + 1 "N/O"	79 697 001
Emergency stop	(red pushbutton + contacts + Ø 80 metal yellow label)	79 697 101
Spring-return pushbuttons	Mushroom head Ø 70 black 1 "N/C" + 1 "N/O"	79 697 101

Dimensions

85 100 293

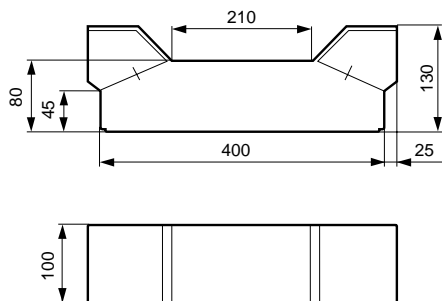

85 100 292

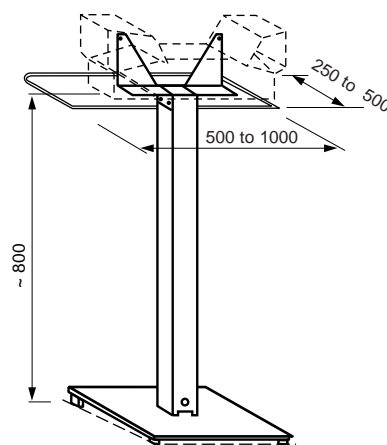

79 697 101

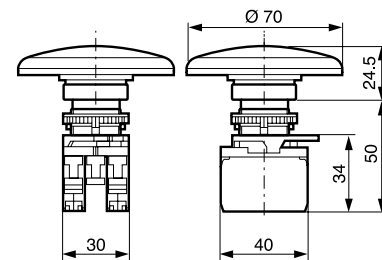

To order, specify:

Standard products

1 Part number

Example: 2-hand control console - 85 100 293

Standard products,
non stocked

Products and specifications subject to change without notice.

Order/Technical Support – Tel: (800) 677-5311 / FAX: (800) 677-3865 / www.crouzet-usa.com



Products and specifications subject to change without notice.

Order/Technical Support – Tel: (800) 677-5311 / FAX: (800) 677-3865 / www.crouzet-usa.com

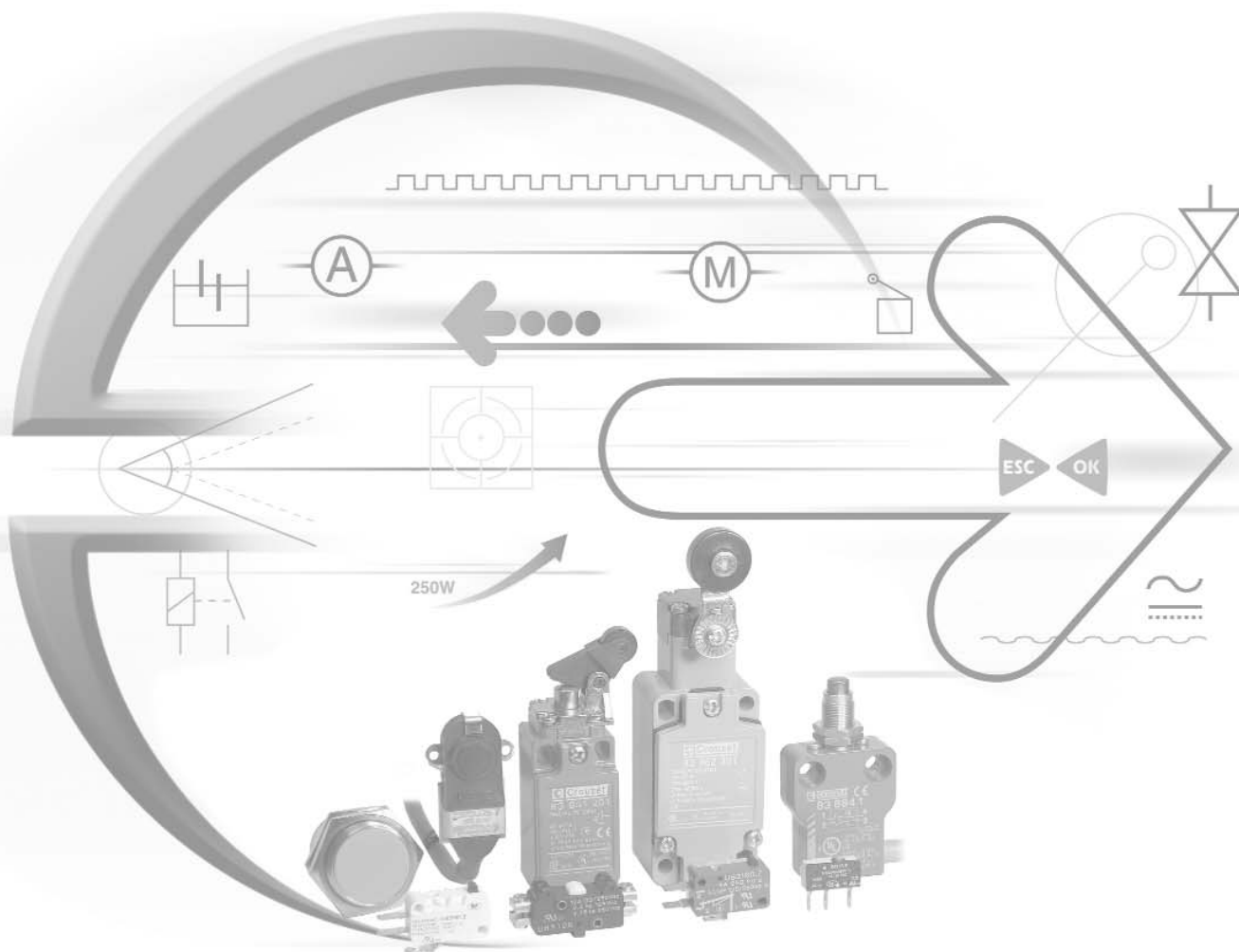

Proximity Sensors



Products and specifications subject to change without notice.

Order/Technical Support – Tel: (800) 677-5311 / FAX: (800) 677-3865 / www.crouzet-usa.com



Products and specifications subject to change without notice.

Order/Technical Support – Tel: (800) 677-5311 / FAX: (800) 677-3865 / www.crouzet-usa.com

Analog Inductive Proximity Detectors

The analog sensors offer an output voltage variation which is linear and proportional to the distance of the object being detected. The output voltage will be reduced as the object approaches the sensor.

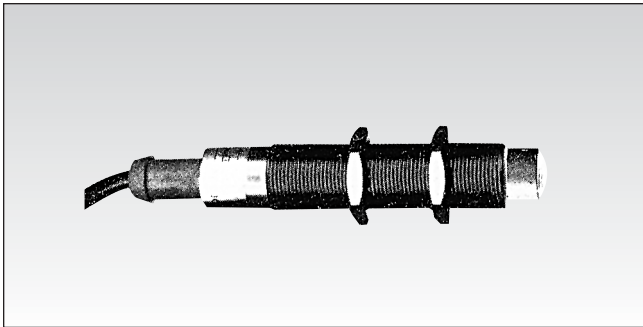

Form	M 18 x 1 x 80
Sensing distance in linear zone (mm)	5
Housing	Stainless Steel
Connection type	PVC 2.0 meter cable
Part number reference	IMB1805T
Min./max. supply voltage	12 to 24 VDC
Own consumption (I _o)	1 mA
Output voltage at 5mm	3 V
Voltage limits in linear zone	0.4 to 3 V at 24 VDC
Load resistance	10 to 100 k
Constant ratio in linear zone	At 24 V 52 mV / 0.1mm
	At 12 V 26 mV / 0.1mm
Switching frequency	10 kHz
Operating temperature	0 to 60°C

Accessories

Mounting flanges, see page 3/102
Connectors, see pages 3/100 to 3/101

Wiring

Wiring diagram

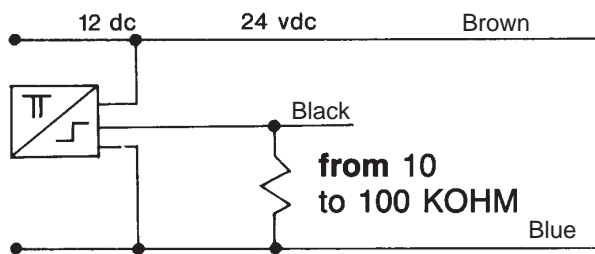

Response curve

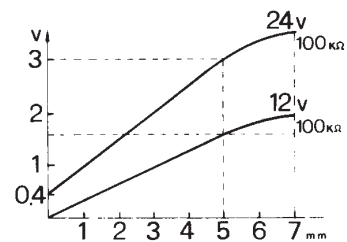

Other Information:

For other characteristics, longer cables, longer barrels, different connectors, please consult the factory.

To order, please specify: **IMB1805T** Normally stocked items Catalog items produced to order

Products and specifications subject to change without notice.

Order/Technical Support – Tel: (800) 677-5311 / FAX: (800) 677-3865 / www.crouzet-usa.com

Inductive Proximity Detectors - Ø 4, M5, Ø 6.5, M8 - Cable

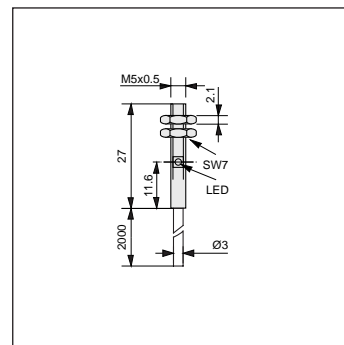
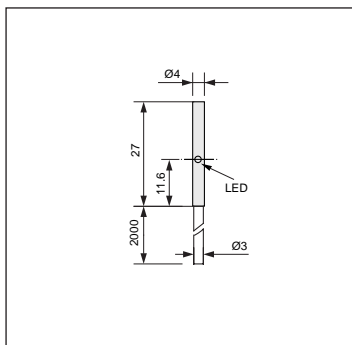
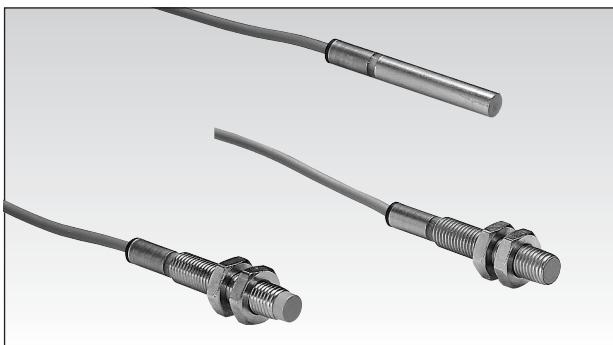

Form	Ø 4 screened
Nominal sensing distance Sn (mm)	0.8
Housing	Stainless steel
Tightening torque (Nm)	—
Termination	2 m PVC cable *M8s/steel connector

Form	M5 screened
Nominal sensing distance Sn (mm)	0.8
Housing	Stainless steel
Tightening torque (Nm)	2.5
Termination	2 m PVC cable *M8s/steel connector

Part numbers

3-wire DC types	
PNP	NO
	NC
NPN	NO
	NC
Min/max. supply voltage	10 to 30 V $\bar{\text{=}}$
Max. load current (Ia)	150 mA
Residual open-state current (Ir) / Own consumption (Io)	0.05 mA / 17.5 mA
Voltage drop in closed state (Ud) / Max. ripple factor (Vr)	2.5 V / < 10 %
Switching frequency / Delay on pick-up (td)	1 kHz / 10 ms
LED indicator	yes
Protection against permanent short-circuits and overloads	yes
Protection against mis-connections of any type	yes
Conductor cross-section / External cable diameter	3 x 0.14 mm ² / 3 mm

84 717 000
84 717 001
84 717 100
84 717 101

*84 717 022
*84 717 023
*84 717 122
*84 717 123

84 717 002
84 717 003
84 717 102
84 717 103

*84 717 024
*84 717 025
*84 717 124
*84 717 125

Inductive Proximity Detectors - M8 - Connectors

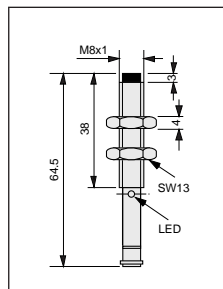
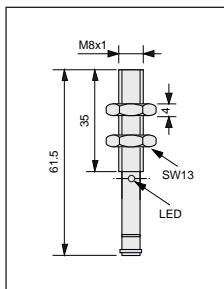

Form	M8 screened
Nominal sensing distance Sn (mm)	1
Housing	Stainless steel
Tightening torque (Nm)	10
Termination	M8 s/steel connector

Form	M8 non-screened
Nominal sensing distance Sn (mm)	2
Housing	Stainless steel
Tightening torque (Nm)	10
Termination	M8 s/steel connector

Part numbers

3-wire DC types	
PNP	NO
	NC
NPN	NO
	NC
Min/max. supply voltage	10 to 40 V $\bar{\text{=}}$
Max. load current (Ia)	200 mA
Residual open-state current (Ir) / Own consumption (Io)	0.05 mA / 7 mA
Voltage drop in closed state (Ud) / Max. ripple factor (Vr)	3 V / < 10 %
Switching frequency / Delay on pick-up (td)	2 kHz / 50 ms
LED indicator	yes
Protection against permanent short-circuits and overloads	yes
Protection against mis-connections of any type	yes

84 717 010
84 717 011
84 717 110
84 717 111

84 717 012
84 717 013
84 717 112
84 717 113

Accessories
Mounting flanges, see page 3/102
Connectors, see pages 3/100 to 3/101

Other information

Special adaptations are available depending on the type of request and quantity required. Eg. cable length, tube length, connector type, etc.

Products and specifications subject to change without notice.

Order/Technical Support – Tel: (800) 677-5311 / FAX: (800) 677-3865 / www.crouzet-usa.com

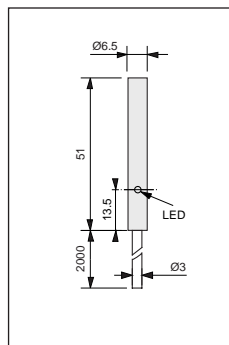

Ø 6.5 screened
1.5
Stainless steel
—
2 m PVC cable

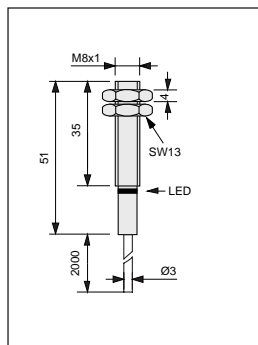

M8 screened
1
Stainless steel
10
2 m PVC cable

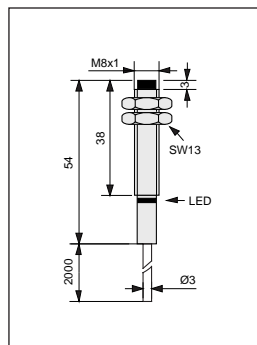

M8 non-screened
2
Stainless steel
10
2 m PVC cable

1

84 717 004
84 717 005
84 717 104
84 717 105
10 to 40 V \equiv
200 mA
0.05 mA / 7 mA
3 V / < 10 %
2 kHz / 50 ms
yes
yes
yes
3 x 0.14 mm² / 3 mm

84 717 006
84 717 007
84 717 106
84 717 107
10 to 40 V \equiv
200 mA
0.05 mA / 7 mA
3 V / < 10 %
2 kHz / 50 ms
yes
yes
yes
3 x 0.14 mm² / 3 mm

84 717 008
84 717 009
84 717 108
84 717 109
10 to 40 V \equiv
200 mA
0.05 mA / 7 mA
3 V / < 10 %
1.5 kHz / 50 ms
yes
yes
yes
3 x 0.14 mm² / 3 mm

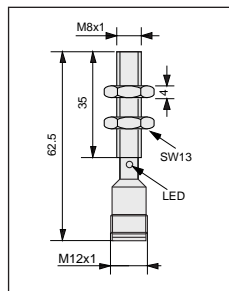

M8 screened
1
Stainless steel
10
M12 s/steel connector

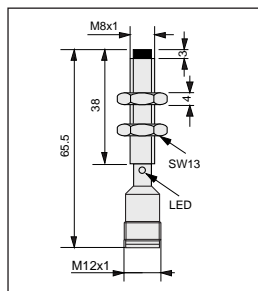

M8 non-screened
2
Stainless steel
10
M12 stainless steel connector

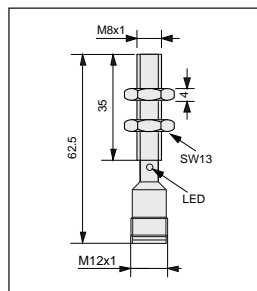

M8 screened
1
Stainless steel
10
M12 plastic connector

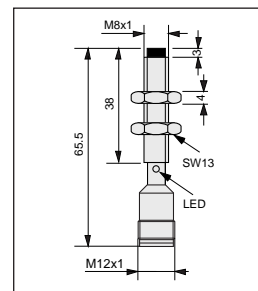

M8 non-screened
2
Stainless steel
10
M12 plastic connector

1

84 717 014
84 717 015
84 717 114
84 717 115
10 to 40 V \equiv
200 mA
0.05 mA / 7 mA
3 V / < 10 %
2 kHz / 50 ms
yes
yes
yes

84 717 016
84 717 017
84 717 116
84 717 117
10 to 40 V \equiv
200 mA
0.05 mA / 7 mA
3 V / < 10 %
1.5 kHz / 50 ms
yes
yes
yes

84 717 018
84 717 019
84 717 118
84 717 119
10 to 40 V \equiv
200 mA
0.05 mA / 7 mA
3 V / < 10 %
2 kHz / 50 ms
yes
yes
yes

84 717 020
84 717 021
84 717 120
84 717 121
10 to 40 V \equiv
200 mA
0.05 mA / 7 mA
3 V / < 10 %
1.5 kHz / 50 ms
yes
yes
yes

To order, specify:

Standard products

Standard products,
non stocked

1 Part number
Example : Inductive proximity detector Ø4 84 717 000

Products and specifications subject to change without notice.

Order/Technical Support – Tel: (800) 677-5311 / FAX: (800) 677-3865 / www.crouzet-usa.com

Inductive Proximity Detectors - M12 - Stainless Steel

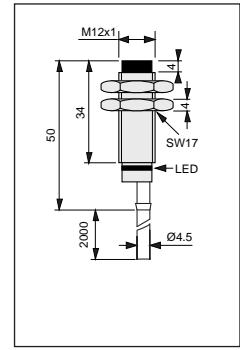
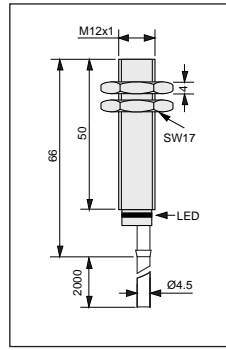
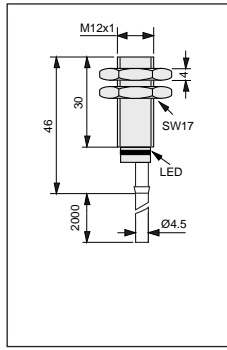
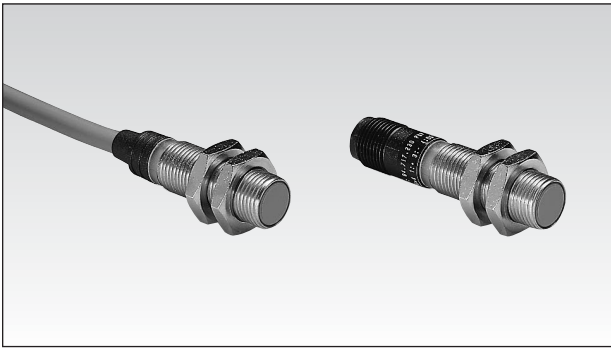

Form	M12 screened	M12 long, screened	M12 non-screened
Nominal sensing distance S_n (mm)	2	2	4
Housing	Stainless steel	Stainless steel	Stainless steel
Tightening torque (Nm)	25	25	25
Termination	2 m PVC cable	2 m PVC cable	2 m PVC cable

Part numbers

3-wire DC types

PNP	NO		84 717 226	84 717 026	84 717 228	
	NC		84 717 227	84 717 027	84 717 229	
NPN	NO		84 717 326	84 717 126	84 717 328	
	NC		84 717 327	84 717 127	84 717 329	
Min/max. supply voltage	10 to 40 V ---		10 to 40 V ---		10 to 40 V ---	
Max. load current (Ia)	200 mA		200 mA		200 mA	
Residual open-state current (Ir) / Own consumption (Io)	0.05 mA / 6.5 mA		0.05 mA / 6.5 mA		0.05 mA / 6.5 mA	
Voltage drop in closed state (Ud) / Max. ripple factor (Vr)	2 V / < 10 %		2 V / < 10 %		2 V / < 10 %	
Switching frequency / Delay on pick-up (td)	800 Hz / 10 ms		800 Hz / 10 ms		400 Hz / 10 ms	
LED indicator	yes		yes		yes	
Protection against permanent short-circuits and overloads	yes		yes		yes	
Protection against mis-connections of any type	yes		yes		yes	
Conductor cross-section / External cable diameter	3 x 0.3 mm ² / 5.2 mm		3 x 0.3 mm ² / 5.2 mm		3 x 0.3 mm ² / 5.2 mm	

Part numbers

2-wire AC types

Polarity	NO		84 717 626
reversible	NC		84 717 627
Min/max. supply voltage	20 to 250 V \sim		
Min/max. load current (Ia)	5 to 500 mA		
Residual open-state current (Ir)	< 2 mA		
Voltage drop in closed state (Ud)	< 8 V		
Switching frequency / Delay on pick-up (td)	5 Hz / 100 ms		
LED indicator	yes		
Conductor cross-section	2 x 0.5 mm ² / 5.2 mm		

Other information

Special adaptations are available depending on the type of request and quantity required. Eg. cable length, tube length, connector type, etc.

Products and specifications subject to change without notice.

Order/Technical Support – Tel: (800) 677-5311 / FAX: (800) 677-3865 / www.crouzet-usa.com

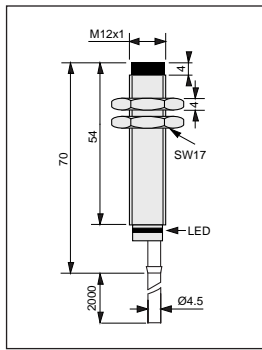

M12 long, non-screened
4
Stainless steel
25
2 m PVC cable

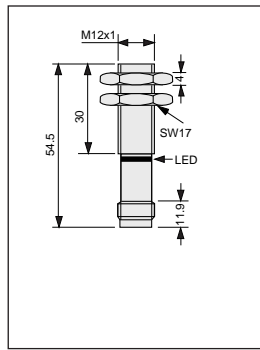

M12 screened
2
Stainless steel
25
M12 plastic connector

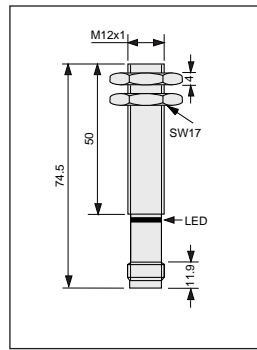

M12 long, screened
2
Stainless steel
25
M12 plastic connector

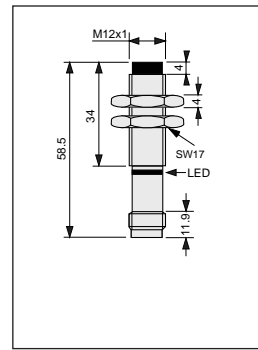

M12 non-screened
4
Stainless steel
25
M12 plastic connector

1

84 717 028
84 717 029
84 717 128
84 717 129
10 to 40 V $\ddot{=}$
200 mA
0.05 mA / 6.5 mA
2 V / < 10 %
400 Hz / 10 ms
yes
yes
yes
3 x 0.3 mm² / 4.5 mm

84 717 230
84 717 231
84 717 330
84 717 331
10 to 40 V $\ddot{=}$
200 mA
0.05 mA / 6.5 mA
2 V / < 10 %
800 Hz / 10 ms
yes
yes
yes
—

84 717 030
84 717 031
84 717 130
84 717 131
10 to 40 V $\ddot{=}$
200 mA
0.05 mA / 6.5 mA
2 V / < 10 %
800 Hz / 10 ms
yes
yes
yes
—

84 717 232
84 717 233
84 717 332
84 717 333
10 to 40 V $\ddot{=}$
200 mA
0.05 mA / 6.5 mA
2 V / < 10 %
400 Hz / 10 ms
yes
yes
yes
—

Continued on
page 3/82

1

84 717 628
84 717 629
20 to 250 V \sim
5 to 500 mA
< 2 mA
< 8 V
5 Hz / 100 ms
yes
2 x 0.5 mm² / 5.2 mm

—
—
—
—
—
—
—
—
—
—

84 717 630
84 717 631
20 to 250 V \sim
5 to 500 mA
< 2 mA
< 8 V
5 Hz / 100 ms
yes
—

—
—
—
—
—
—
—
—
—
—

Continued on
page 3/82

3

To order, specify:

Standard products

Standard products,
non stocked

1 Part number

Example : Inductive proximity detector M12 84 717 226

Products and specifications subject to change without notice.

Order/Technical Support – Tel: (800) 677-5311 / FAX: (800) 677-3865 / www.crouzet-usa.com

Inductive Proximity Detectors - M12 - Stainless Steel

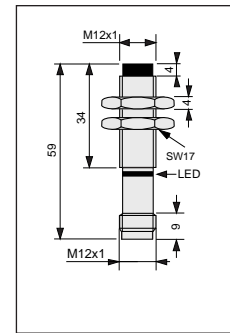
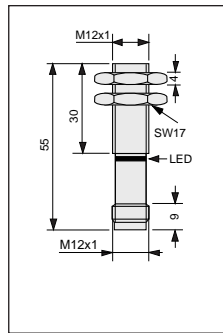
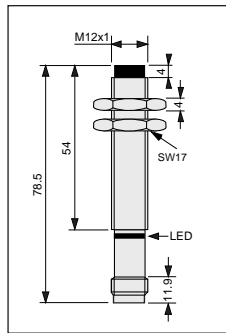

Form
Nominal sensing distance Sn (mm)
Housing
Tightening torque (Nm)
Termination

M12 long, non-screened
4
Stainless steel
25
M12 plastic connector

M12 screened
2
Stainless steel
25
M12 s/steel connector

M12 non-screened
4
Stainless steel
25
M12 s/steel connector

Part numbers

3-wire DC types

PNP	NO	
	NC	
NPN	NO	
	NC	
Min/max. supply voltage		
Max. load current (Ia)		
Residual open-state current (Ir) / Own consumption (Io)		
Voltage drop in closed state (Ud) / Max. ripple factor (Vr)		
Switching frequency / Delay on pick-up (td)		
LED indicator		
Protection against permanent short-circuits and overloads		
Protection against mis-connections of any type		

84 717 032
84 717 033
84 717 132
84 717 133
10 to 40 V =
200 mA
0.05 mA / 6.5 mA
2 V / < 10 %
400 Hz / 10 ms
yes
yes
yes

84 717 246
84 717 247
84 717 346
84 717 347
10 to 40 V =
200 mA
0.05 mA / 6.5 mA
2 V / < 10 %
800 Hz / 10 ms
yes
yes
yes

84 717 248
84 717 249
84 717 348
84 717 349
10 to 40 V =
200 mA
0.05 mA / 6.5 mA
2 V / < 10 %
400 Hz / 10 ms
yes
yes
yes

1

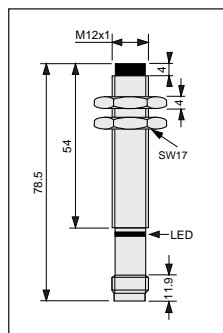

Form
Nominal sensing distance Sn (mm)
Housing
Tightening torque (Nm)
Termination

M12 non-screened
4
Stainless steel
25
M12 plastic connector

M12 screened
2
Stainless steel
25
M12s/steel connector

M12 non-screened
2
Stainless steel
25
M12s/steel connector

Part numbers

2-wire AC types

Polarity NO
reversible NC
Min/max. supply voltage
Min/max. load current (Ia)
Residual open-state current (Ir)
Voltage drop in closed state (Ud)
Switching frequency / Delay on pick-up (td)
LED indicator

84 717 632
84 717 633
20 to 250 V ~
5 to 500 mA
< 2 mA
< 8 V
5 Hz / 100 ms
yes

84 717 646
84 717 647
20 to 250 V ~
5 to 500 mA
< 2 mA
< 8 V
5 Hz / 100 ms
yes

84 717 648
84 717 649
20 to 250 V ~
5 to 500 mA
< 2 mA
< 8 V
5 Hz / 100 ms
yes

Accessories

Mounting flanges, see page 3/102
Connectors, see pages 3/100 to 3/101

1

Other information

Special adaptations are available depending on the type of request and quantity required. Eg. cable length, tube length, connector type, etc.

Products and specifications subject to change without notice.

Order/Technical Support – Tel: (800) 677-5311 / FAX: (800) 677-3865 / www.crouzet-usa.com

Inductive Proximity Detectors - M12 - Plastic

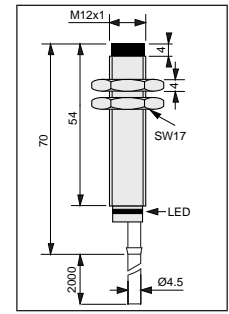
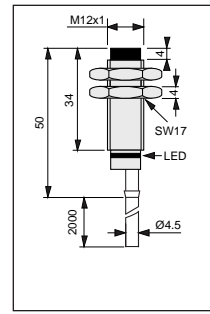
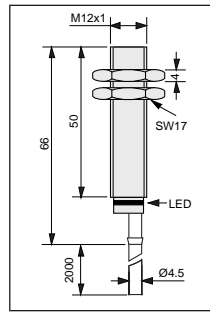
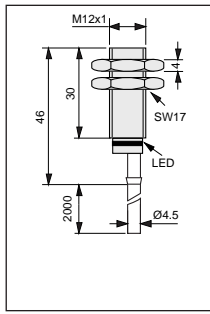
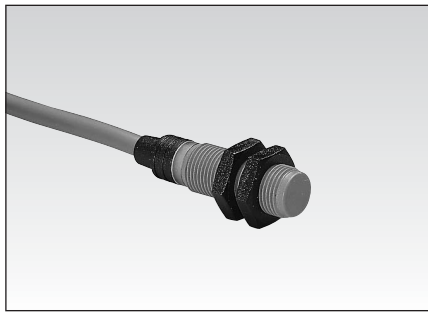

Form	M12 screened	M12 long, screened	M12 non-screened	M12 long, non-screened
Nominal sensing distance Sn (mm)	2	2	4	4
Housing	Plastic	Plastic	Plastic	Plastic
Tightening torque (Nm)	1.5	1.5	1.5	1.5
Termination	2 m PVC cable	2 m PVC cable	2 m PVC cable	2 m PVC cable

Part numbers

3-wire DC types

PNP	NO	
	NC	
NPN	NO	
	NC	
Min/max. supply voltage		
10 to 40 V $\overline{\text{=}}$		
Max. load current (Ia)		
200 mA		
Residual open-state current (Ir) / Own consumption (Io)		
0.05 mA / 6.5 mA		
Voltage drop in closed state (Ud) / Max. ripple factor (Vr)		
2 V / < 10 %		
Switching frequency / Delay on pick-up (td)		
800 Hz / 10 ms		
LED indicator		
yes		
Protection against perm. short-circuits and overloads		
yes		
Protection against mis-connections of any type		
yes		
Conductor cross-section / External cable diameter		
3 x 0.3 mm ² / 5.2 mm		

84 717 238	84 717 038	84 717 240	84 717 040
84 717 239	84 717 039	84 717 241	84 717 041
84 717 338	84 717 138	84 717 340	84 717 140
84 717 339	84 717 139	84 717 341	84 717 141

84 717 238	84 717 038	84 717 240	84 717 040
84 717 239	84 717 039	84 717 241	84 717 041
84 717 338	84 717 138	84 717 340	84 717 140
84 717 339	84 717 139	84 717 341	84 717 141

84 717 238	84 717 038	84 717 240	84 717 040
84 717 239	84 717 039	84 717 241	84 717 041
84 717 338	84 717 138	84 717 340	84 717 140
84 717 339	84 717 139	84 717 341	84 717 141

84 717 238	84 717 038	84 717 240	84 717 040
84 717 239	84 717 039	84 717 241	84 717 041
84 717 338	84 717 138	84 717 340	84 717 140
84 717 339	84 717 139	84 717 341	84 717 141

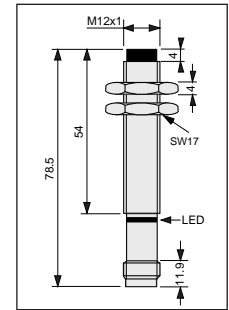
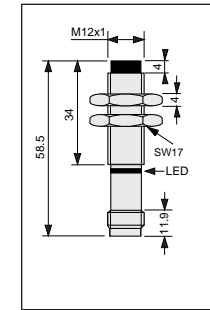
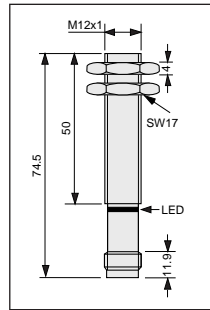
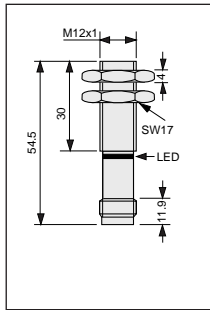

Form	M12 screened	M12 long, screened	M12 non-screened	M12 long, non-screened
Nominal sensing distance Sn (mm)	2	2	4	4
Housing	Plastic	Plastic	Plastic	Plastic
Tightening torque (Nm)	1.5	1.5	1.5	1.5
Termination	M12 plastic connector	M12 plastic connector	M12 plastic connector	M12 plastic connector

Part numbers

3-wire DC types

PNP	NO	
	NC	
NPN	NO	
	NC	
Min/max. supply voltage		
10 to 40 V $\overline{\text{=}}$		
Max. load current (Ia)		
200 mA		
Residual open-state current (Ir) / Own consumption (Io)		
0.05 mA / 6.5 mA		
Voltage drop in closed state (Ud) / Max. ripple factor (Vr)		
2 V / < 10 %		
Switching frequency / Delay on pick-up (td)		
800 Hz / 10 ms		
LED indicator		
yes		
Protection against perm. short-circuits and overloads		
yes		
Protection against mis-connections of any type		
yes		

84 717 242	84 717 042	84 717 244	84 717 044
84 717 243	84 717 043	84 717 245	84 717 045
84 717 342	84 717 142	84 717 344	84 717 144
84 717 343	84 717 143	84 717 345	84 717 145

84 717 242	84 717 042	84 717 244	84 717 044
84 717 243	84 717 043	84 717 245	84 717 045
84 717 342	84 717 142	84 717 344	84 717 144
84 717 343	84 717 143	84 717 345	84 717 145

84 717 242	84 717 042	84 717 244	84 717 044
84 717 243	84 717 043	84 717 245	84 717 045
84 717 342	84 717 142	84 717 344	84 717 144
84 717 343	84 717 143	84 717 345	84 717 145

84 717 242	84 717 042	84 717 244	84 717 044
84 717 243	84 717 043	84 717 245	84 717 045
84 717 342	84 717 142	84 717 344	84 717 144
84 717 343	84 717 143	84 717 345	84 717 145

Accessories

Mounting flanges, see page 3/102
Connectors, see pages 3/100 to 3/101.

To order, specify:

	Standard products		Standard products, non stocked		Part number	Example : Inductive proximity detector M12 84 717 028
--	-------------------	--	--------------------------------	--	-------------	---

Products and specifications subject to change without notice.

Order/Technical Support – Tel: (800) 677-5311 / FAX: (800) 677-3865 / www.crouzet-usa.com

Inductive Proximity Detectors - M18 - Stainless Steel

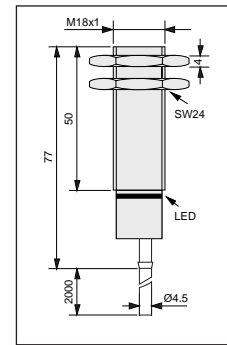
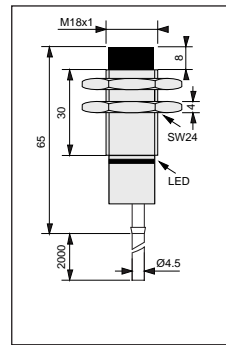
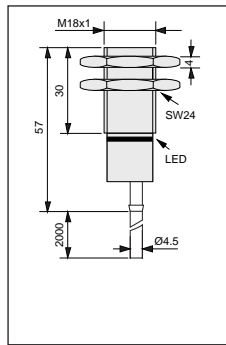

Form
Nominal sensing distance S_n (mm)
Housing
Tightening torque (Nm)
Termination

M18 screened
5
Stainless steel
50
2 m PVC cable
*M12s/steel connector

M18 non-screened
8
Stainless steel
50
2 m PVC cable
*M12s/steel connector

M18 long, screened
5
Stainless steel
50
2 m PVC cable

Part numbers

3-wire DC types

PNP	NO
	NC
NPN	NO
	NC

84 717 250
84 717 251
84 717 350
84 717 351
10 to 40 V ---
200 mA
0.05 mA / 6.5 mA
2 V / < 10 %
500 Hz / 10 ms
yes
yes
yes
3 x 0.3 mm ² / 5.2 mm

84 717 252
84 717 253
84 717 352
84 717 353
10 to 40 V ---
200 mA
0.05 mA / 6.5 mA
2 V / < 10 %
400 Hz / 10 ms
yes
yes
yes
3 x 0.3 mm ² / 5.2 mm

84 717 050
84 717 051
84 717 150
84 717 151
10 to 40 V ---
200 mA
0.05 mA / 6.5 mA
2 V / < 10 %
500 Hz / 10 ms
yes
yes
yes
3 x 0.3 mm ² / 5.2 mm

Part numbers

2-wire AC types

Polarity	NO
reversible	NC
Min/max. supply voltage	
Min/max. load current (Ia)	
Residual open-state current (I _r)	
Voltage drop in closed state (U _d)	
Switching frequency / Delay on pick-up (t _d)	
LED indicator	
Conductor cross-section	

84 717 650	*84 717 672
84 717 651	*84 717 673
20 to 250 V \sim	
5 to 500 mA	
< 2 mA	
< 8 V	
5 Hz / 100 ms	
yes	
2 x 0.5 mm ² / 5.2 mm	

84 717 652	*84 717 670
84 717 653	*84 717 671
20 to 250 V \sim	
5 to 500 mA	
< 2 mA	
< 8 V	
5 Hz / 100 ms	
yes	
2 x 0.5 mm ² / 5.2 mm	

Other information

Special adaptations are available depending on the type of request and quantity required. Eg. cable length, tube length, connector type, etc.

Products and specifications subject to change without notice.

Order/Technical Support – Tel: (800) 677-5311 / FAX: (800) 677-3865 / www.crouzet-usa.com

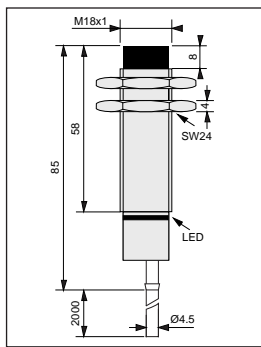

M18 long, non-screened
8
Stainless steel
50
2 m PVC cable

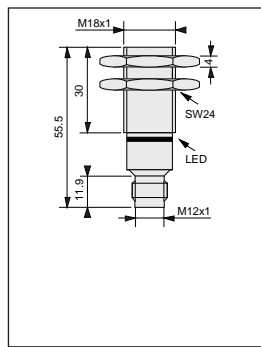

M18 screened
5
Stainless steel
50
M12 plastic connector
*M12s/steel connector

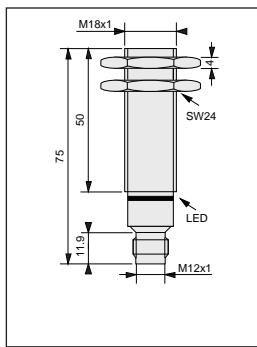

M18 long, screened
5
Stainless steel
50
M12 plastic connector

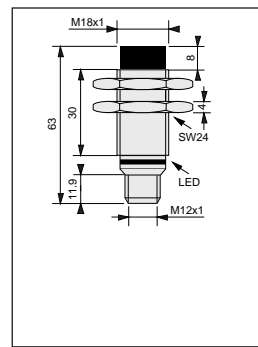

M18 non-screened
8
Stainless steel
50
M12 plastic connector
*M12s/steel connector

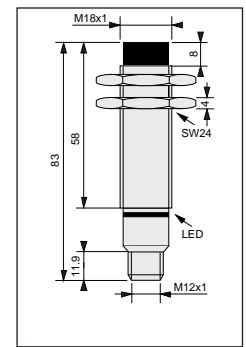

M18 long, non-screened
8
Stainless steel
50
M12 plastic connector

1

84 717 052
84 717 053
84 717 152
84 717 153
10 to 40 V $\bar{\bar{=}}$
200 mA
0.05 mA / 6.5 mA
2 V / < 10 %
400 Hz / 10 ms
yes
yes
yes
3 x 0.3 mm² / 5.2 mm

84 717 254 *84 717 258
84 717 255 *84 717 259
84 717 354 *84 717 358
84 717 355 *84 717 359
10 to 40 V $\bar{\bar{=}}$
200 mA
0.05 mA / 6.5 mA
2 V / < 10 %
500 Hz / 10 ms
yes
yes
yes

84 717 054
84 717 055
84 717 154
84 717 155
10 to 40 V $\bar{\bar{=}}$
200 mA
0.05 mA / 6.5 mA
2 V / < 10 %
500 Hz / 10 ms
yes
yes
yes

84 717 256 *84 717 260
84 717 257 *84 717 261
84 717 356 *84 717 360
84 717 357 *84 717 361
10 to 40 V $\bar{\bar{=}}$
200 mA
0.05 mA / 6.5 mA
2 V / < 10 %
400 Hz / 10 ms
yes
yes
yes

84 717 056
84 717 057
84 717 156
84 717 157
10 to 40 V $\bar{\bar{=}}$
200 mA
0.05 mA / 6.5 mA
2 V / < 10 %
400 Hz / 10 ms
yes
yes
yes

1

84 717 654
84 717 655
20 to 250 V \sim
5 to 500 mA
< 2 mA
< 8 V
5 Hz / 100 ms
yes

84 717 656
84 717 657
20 to 250 V \sim
5 to 500 mA
< 2 mA
< 8 V
5 Hz / 100 ms
yes

3

To order, specify:

Standard products	Standard products, non stocked	Part number Example : Inductive proximity detector M18 84 717 250
-------------------	--------------------------------	--

Products and specifications subject to change without notice.

Order/Technical Support – Tel: (800) 677-5311 / FAX: (800) 677-3865 / www.crouzet-usa.com

Inductive Proximity Detectors - M18 - Plastic

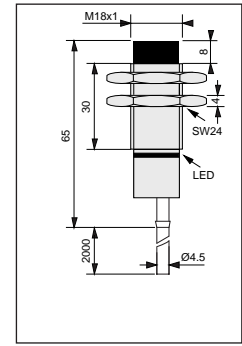
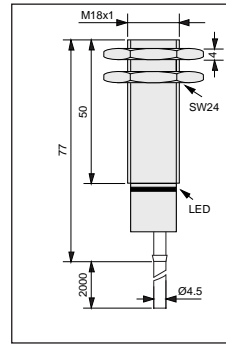
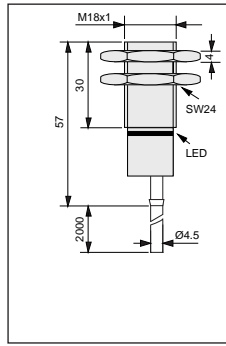
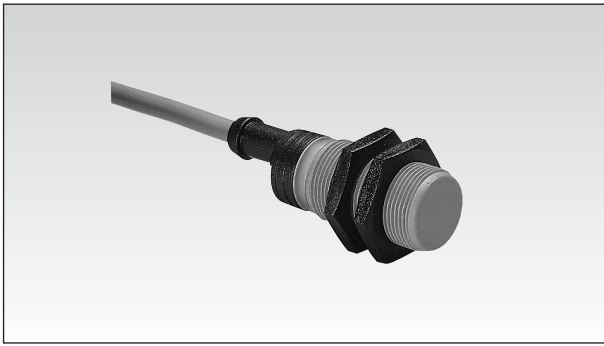

Form
Nominal sensing distance S_n (mm)
Housing
 Tightening torque (Nm)
 Termination

M18 screened	M18 long, screened	M18 non-screened
5	5	8
Plastic	Plastic	Plastic
5	5	5
2 m PVC cable	2 m PVC cable	2 m PVC cable

Part numbers

3-wire DC types

PNP NO NC
NPN NO NC

84 717 262	84 717 062	84 717 264
84 717 263	84 717 063	84 717 265
84 717 362	84 717 162	84 717 364
84 717 363	84 717 163	84 717 365
10 to 40 V $\overline{\text{DC}}$	10 to 40 V $\overline{\text{DC}}$	10 to 40 V $\overline{\text{DC}}$
200 mA	200 mA	200 mA
0.05 mA / 6.5 mA	0.05 mA / 6.5 mA	0.05 mA / 6.5 mA
2 V / < 10 %	2 V / < 10 %	2 V / < 10 %
500 Hz / 10 ms	500 Hz / 10 ms	400 Hz / 10 ms
yes	yes	yes
yes	yes	yes
yes	yes	yes
3 x 0.3 mm ² / 5.2 mm	3 x 0.3 mm ² / 5.2 mm	3 x 0.3 mm ² / 5.2 mm

Part numbers

2-wire AC types

Polarity NO
reversible NC

Min/max. supply voltage
 Min/max. load current (Ia)
 Residual open-state current (I_r)
 Voltage drop in closed state (U_d)
 Switching frequency / Delay on pick-up (t_d)
 LED indicator
 Conductor cross-section

	84 717 662	
	84 717 663	
	20 to 250 V \sim	
	5 to 500 mA	
	< 2 mA	
	< 8 V	
	5 Hz / 100 ms	
	yes	
	2 x 0.5 mm ² / 5.2 mm	

Accessories

Mounting flanges, see page 3/102
 Connectors, see pages 3/100 to 3/101.

Other information

Special adaptations are available depending on the type of request and quantity required. Eg. cable length, tube length, connector type, etc.

Products and specifications subject to change without notice.

Order/Technical Support – Tel: (800) 677-5311 / FAX: (800) 677-3865 / www.crouzet-usa.com

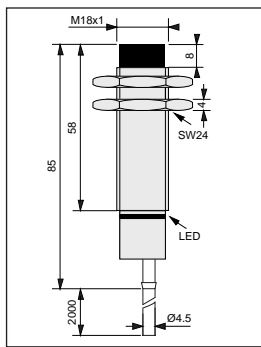

M18 long, non-screened
8
Plastic
5
2 m PVC cable

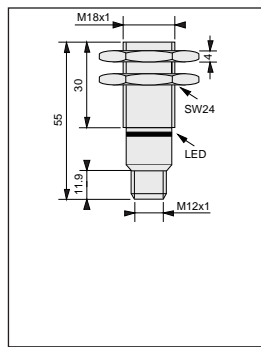

M18 screened
5
Plastic
5
M12 plastic connector

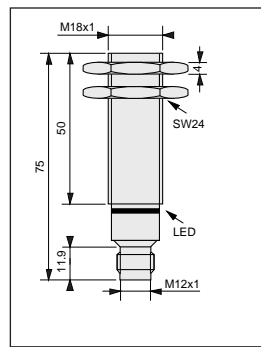

M18 long, screened
5
Plastic
5
M12 plastic connector

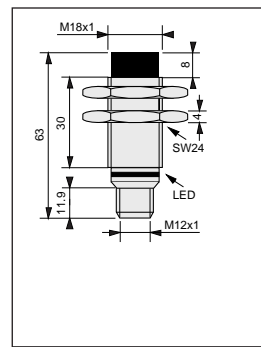

M18 non-screened
8
Plastic
5
M12 plastic connector

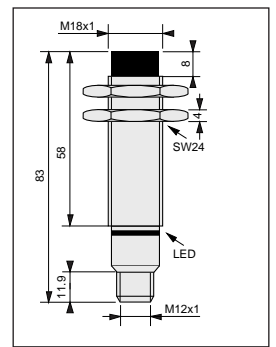

M18 long, non-screened
8
Plastic
5
M12 plastic connector

1

84 717 064
84 717 065
84 717 164
84 717 165
10 to 40 V ~
200 mA
0.05 mA / 6.5 mA
2 V / < 10 %
400 Hz / 10 ms
yes
yes
yes
3 x 0.3 mm² / 5.2 mm

84 717 266
84 717 267
84 717 366
84 717 367
10 to 40 V ~
200 mA
0.05 mA / 6.5 mA
2 V / < 10 %
500 Hz / 10 ms
yes
yes
yes
3 x 0.3 mm² / 5.2 mm

84 717 066
84 717 067
84 717 166
84 717 167
10 to 40 V ~
200 mA
0.05 mA / 6.5 mA
2 V / < 10 %
500 Hz / 10 ms
yes
yes
yes
3 x 0.3 mm² / 5.2 mm

84 717 268
84 717 269
84 717 368
84 717 369
10 to 40 V ~
200 mA
0.05 mA / 6.5 mA
2 V / < 10 %
400 Hz / 10 ms
yes
yes
yes
—

84 717 068
84 717 069
84 717 168
84 717 169
10 to 40 V ~
200 mA
0.05 mA / 6.5 mA
2 V / < 10 %
400 Hz / 10 ms
yes
yes
yes
—

1

84 717 664
84 717 665
20 to 250 V ~
5 to 500 mA
< 2 mA
< 8 V
5 Hz / 100 ms
yes
2 x 0.5 mm² / 5.2 mm

3

To order, specify:

Standard products

Standard products,
non stocked

1 Part number
Example : Inductive proximity detector M18 84 717 056

Products and specifications subject to change without notice.

Order/Technical Support – Tel: (800) 677-5311 / FAX: (800) 677-3865 / www.crouzet-usa.com

Inductive Proximity Detectors - M30 - Stainless Steel - 3-Wire DC Types

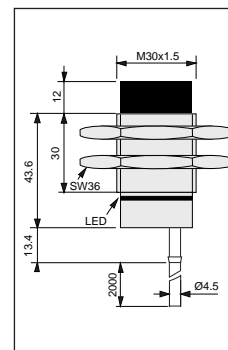
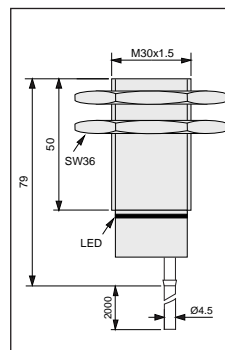
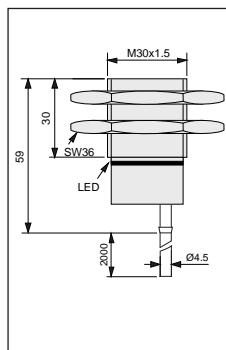
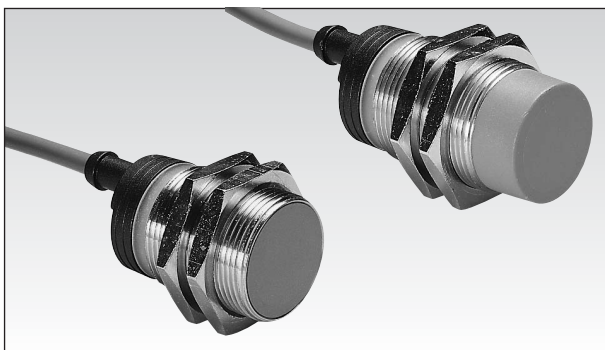

Form
Nominal sensing distance Sn (mm)
Housing
Tightening torque (Nm)
Termination

M30 screened
10
Stainless steel
100
2 m PVC cable

M30 long, screened
10
Stainless steel
100
2 m PVC cable

M30 non-screened
15
Stainless steel
100
2 m PVC cable

Part numbers

PNP	NO	
	NC	
NPN	NO	
	NC	
Min/max. supply voltage		
Max. load current (Ia)		
Residual open-state current (Ir) / Own consumption (Io)		
Voltage drop in closed state (Ud) / Max. ripple factor (Vr)		
Switching frequency (F) / Delay on pick-up (td)		
LED indicator		
Protection against permanent short-circuits and overloads		
Protection against mis-connections of any type		
Conductor cross-section / External cable diameter		

84 717 274
84 717 275
84 717 374
84 717 375
10 to 40 V $\bar{\bar{=}}$
200 mA
0.05 mA / 6.5 mA
2 V / < 10 %
300 Hz / 10 ms
yes
yes
yes
3 x 0.3 mm ² / 5.2 mm

84 717 074
84 717 075
84 717 174
84 717 175
10 to 40 V $\bar{\bar{=}}$
200 mA
0.05 mA / 6.5 mA
2 V / < 10 %
300 Hz / 10 ms
yes
yes
yes
3 x 0.3 mm ² / 5.2 mm

84 717 276
84 717 277
84 717 376
84 717 377
10 to 40 V $\bar{\bar{=}}$
200 mA
0.05 mA / 6.5 mA
2 V / < 10 %
100 Hz / 10 ms
yes
yes
yes
3 x 0.3 mm ² / 5.2 mm

1

Inductive Proximity Detectors - M30 - Stainless Steel - 2-Wire AC Types

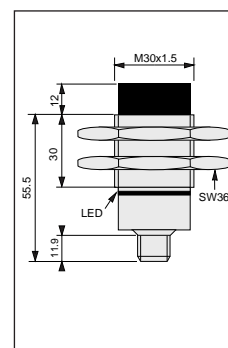
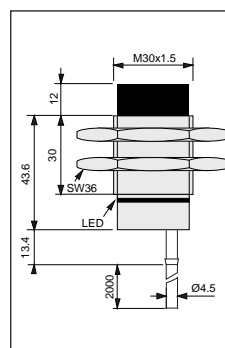
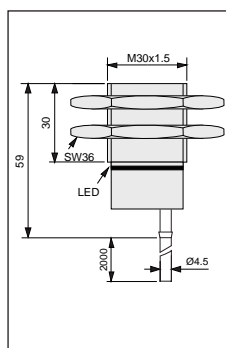
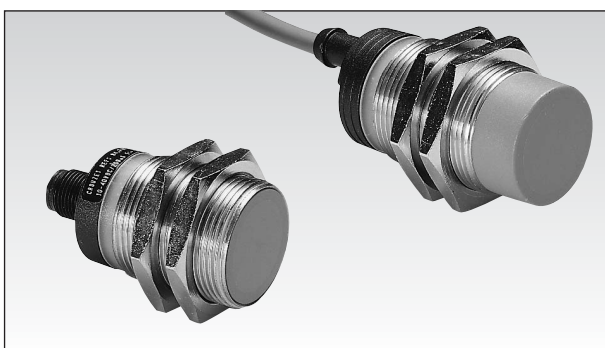

Form
Nominal sensing distance Sn (mm)
Housing
Tightening torque (Nm)
Termination

M30 screened
10
Stainless steel
100
2 m PVC cable

M30 non-screened
15
Stainless steel
100
2 m PVC cable

M30 non-screened
15
Stainless steel
100
M12 plastic connector

Part numbers

Polarity	NO	
reversible	NC	
Min/max. supply voltage		
Min/max. load current (Ia)		
Residual open-state current (Ir)		
Voltage drop in closed state (Ud)		
Switching frequency (F) / Delay on pick-up (td)		
LED indicator		
Conductor cross-section		

84 717 674
84 717 675
20 to 250 V \sim
5 to 500 mA
< 2 mA
< 8 V
5 Hz / 100 ms
yes
2 x 0.5 mm ² / 5.2 mm

84 717 676
84 717 677
20 to 250 V \sim
5 to 500 mA
< 2 mA
< 8 V
5 Hz / 100 ms
yes
2 x 0.5 mm ² / 5.2 mm

84 717 680
84 717 681
20 to 250 V \sim
5 to 500 mA
< 2 mA
< 8 V
5 Hz / 100 ms
yes
—

1

Other information

Special adaptations are available depending on the type of request and quantity required. Eg. cable length, tube length, connector type, etc.

Products and specifications subject to change without notice.

Order/Technical Support – Tel: (800) 677-5311 / FAX: (800) 677-3865 / www.crouzet-usa.com

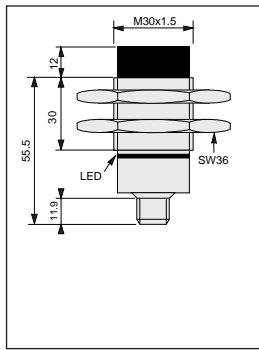

M30 non-screened
15
Stainless steel
100
M12 plastic connector

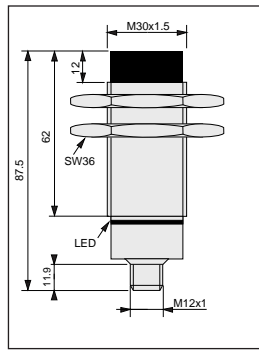

M30 long, non-screened
15
Stainless steel
100
M12 plastic connector

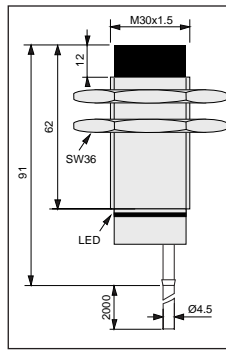

M30 long, non-screened
15
Stainless steel
100
2 m PVC cable

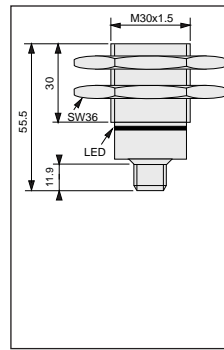

M30 screened
10
Stainless steel
100
M12 plastic connector
*M12s/steel connector

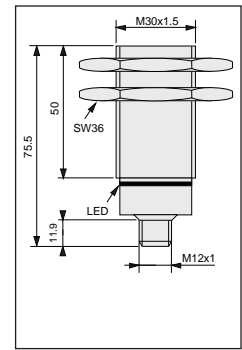

M30 long, screened
10
Stainless steel
100
M12 plastic connector
*M12s/steel connector

84 717 280
84 717 281
84 717 380
84 717 381
10 to 40 V ---
200 mA
0.05 mA / 6.5 mA
2 V / < 10 %
100 Hz / 10 ms
yes
yes
yes

84 717 080
84 717 081
84 717 180
84 717 181
10 to 40 V ---
200 mA
0.05 mA / 6.5 mA
2 V / < 10 %
100 Hz / 10 ms
yes
yes
yes

84 717 076
84 717 077
84 717 176
84 717 177
10 to 40 V ---
200 mA
0.05 mA / 6.5 mA
2 V / < 10 %
100 Hz / 10 ms
yes
yes
yes
3 x 0.3 mm² / 5.2 mm

84 717 278 ***84 717 282**
84 717 279 ***84 717 283**
84 717 378 ***84 717 382**
84 717 379 ***84 717 383**
10 to 40 V ---
200 mA
0.05 mA / 6.5 mA
2 V / < 10 %
300 Hz / 10 ms
yes
yes
yes

84 717 078 ***84 717 284**
84 717 079 ***84 717 285**
84 717 178 ***84 717 384**
84 717 179 ***84 717 385**
10 to 40 V ---
200 mA
0.05 mA / 6.5 mA
2 V / < 10 %
300 Hz / 10 ms
yes
yes
yes

1

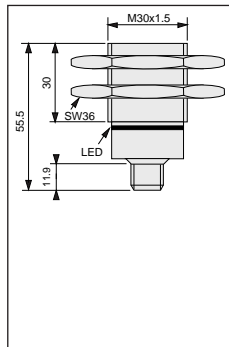

M30 screened
10
Stainless steel
100
M12 plastic connector

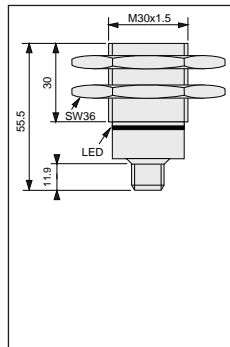

M30 screened
10
Stainless steel
100
M12s/steel connector

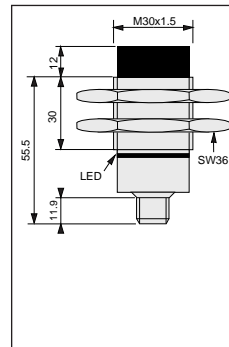

M30 non-screened
15
Stainless steel
100
M12s/steel connector

84 717 678
84 717 679
20 to 250 V ~
5 to 500 mA
< 2 mA
< 8 V
5 Hz / 100 ms
yes

84 717 694
84 717 695
20 to 250 V ~
5 to 500 mA
< 2 mA
< 8 V
5 Hz / 100 ms
yes

84 717 684
84 717 685
20 to 250 V ~
5 to 500 mA
< 2 mA
< 8 V
5 Hz / 100 ms
yes

1

To order, specify:

Standard products	Standard products, non stocked	Part number Example : Inductive proximity detector M30 84 717 274
-------------------	--------------------------------	--

Products and specifications subject to change without notice.

Order/Technical Support – Tel: (800) 677-5311 / FAX: (800) 677-3865 / www.crouzet-usa.com

Inductive Proximity Detectors - M30 - Plastic

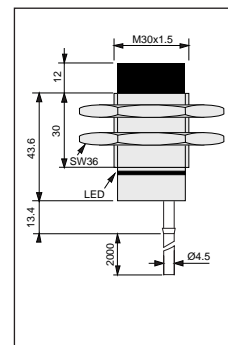
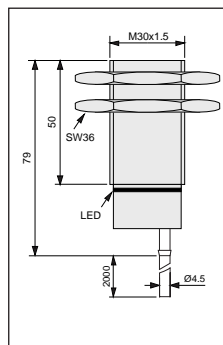
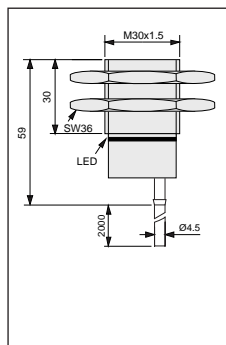
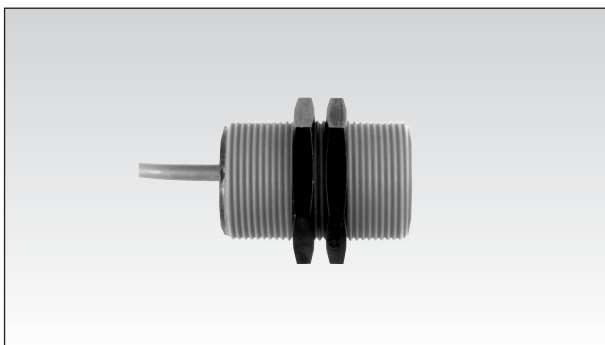

Form
Nominal sensing distance Sn (mm)
Housing
Tightening torque (Nm)
Termination

M30 screened
10
Plastic
15
2 m PVC cable

M30 long, screened
10
Plastic
15
2 m PVC cable

M30 non-screened
15
Plastic
15
2 m PVC cable

Part numbers

3-wire DC types

PNP	NO
	NC
NPN	NO
	NC

84 717 286
84 717 287
84 717 386
84 717 387
10 to 40 V ---
200 mA
0.05 mA / 6.5 mA
2 V / < 10 %
300 Hz / 10 ms
yes
yes
yes
3 x 0.3 mm ² / 5.2 mm

84 717 086
84 717 087
84 717 186
84 717 187
10 to 40 V ---
200 mA
0.05 mA / 6.5 mA
2 V / < 10 %
300 Hz / 10 ms
yes
yes
yes
3 x 0.3 mm ² / 5.2 mm

84 717 288
84 717 289
84 717 388
84 717 389
10 to 40 V ---
200 mA
0.05 mA / 6.5 mA
2 V / < 10 %
100 Hz / 10 ms
yes
yes
yes
3 x 0.3 mm ² / 5.2 mm

Part numbers

2-wire AC types

Polarity NO
reversible NC

Min/max. supply voltage
Min/max. load current (Ia)
Residual open-state current (Ir)
Voltage drop in closed state (Ud)
Switching frequency (F) / Delay on pick-up (td)
LED indicator
Conductor cross-section

84 717 686
84 717 687
20 to 250 V ~
5 to 500 mA
< 2 mA
< 8 V
5 Hz / 100 ms
yes
2 x 0.5 mm ² / 5.2 mm

Accessories

Mounting flanges, see page 3/102
Connectors, see pages 3/100 to 3/101

Other information

Special adaptations are available depending on the type of request and quantity required. Eg. cable length, tube length, connector type, etc.

Products and specifications subject to change without notice.

Order/Technical Support – Tel: (800) 677-5311 / FAX: (800) 677-3865 / www.crouzet-usa.com

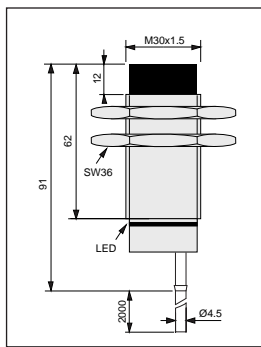

M30 long, non-screened
15
Plastic
15
2 m PVC cable

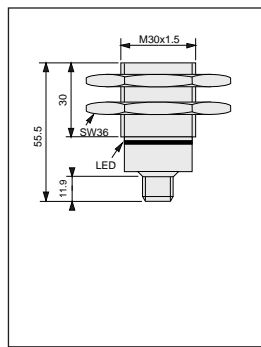

M30 screened
10
Plastic
25
M12 plastic connector

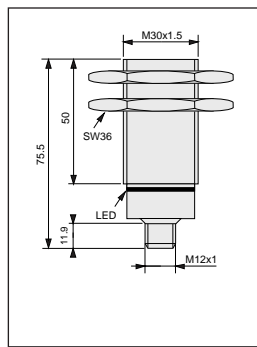

M30 long, screened
10
Plastic
15
M12 plastic connector

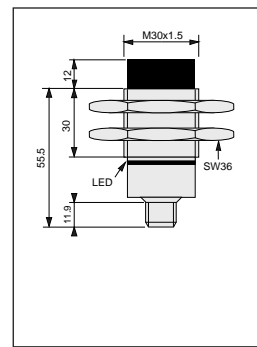

M30 non-screened
15
Plastic
15
M12 plastic connector

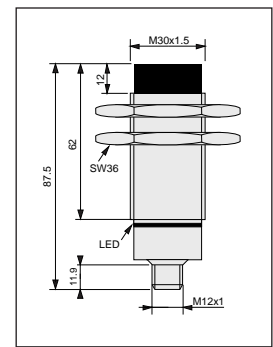

M30 long, non-screened
15
Plastic
15
M12 plastic connector

1

84 717 088
84 717 089
84 717 188
84 717 189
10 to 40 V ~
200 mA
0.05 mA / 6.5 mA
2 V / < 10 %
100 Hz / 10 ms
yes
yes
yes
3 x 0.3 mm² / 5.2 mm

84 717 290
84 717 291
84 717 390
84 717 391
10 to 40 V ~
200 mA
0.05 mA / 6.5 mA
2 V / < 10 %
300 Hz / 10 ms
yes
yes
yes
—

84 717 090
84 717 091
84 717 190
84 717 191
10 to 40 V ~
200 mA
0.05 mA / 6.5 mA
2 V / < 10 %
300 Hz / 10 ms
yes
yes
yes
—

84 717 292
84 717 293
84 717 392
84 717 393
10 to 40 V ~
200 mA
0.05 mA / 6.5 mA
2 V / < 10 %
100 Hz / 10 ms
yes
yes
yes
—

84 717 092
84 717 093
84 717 192
84 717 193
10 to 40 V ~
200 mA
0.05 mA / 6.5 mA
2 V / < 10 %
100 Hz / 10 ms
yes
yes
yes
—

1

84 717 688
84 717 689
20 to 250 V ~
5 to 500 mA
< 2 mA
< 8 V
5 Hz / 100 ms
yes
2 x 0.5 mm² / 5.2 mm

—
—
—
—
—
—
—
—
—

—
—
—
—
—
—
—
—
—

—
—
—
—
—
—
—
—
—

—
—
—
—
—
—
—
—
—

3

To order, specify:

Standard products

Standard products, non stocked

1 Part number

Example : Inductive proximity detector M30 84 717 286

Products and specifications subject to change without notice.

Order/Technical Support – Tel: (800) 677-5311 / FAX: (800) 677-3865 / www.crouzet-usa.com

Inductive Proximity Detectors - Flat Pack

- 4-wire NO and NC operation
- Easy to mount: only 2 M 3.5 screws required
- Ideal for conveying and packaging machine applications
- Capacitive detection version available in same housing
- EMC immunity: 10 V/m



Form
 Nominal sensing distance S_n (mm)
 Housing
 Tightening torque (Nm)
 Termination

55 x 35 screened	55 x 35 non-screened
10	15
Plastic	Plastic
—	—
2 m PVC cable Connector	2 m PVC cable Connector

Part numbers

4-wire DC types

PNP NO / NC

NPN NO / NC

Min/max. supply voltage

Max. load current (Ia)

Residual open-state current (Ir) / Own consumption (Io)

Voltage drop in closed state (Ud) / Max. ripple factor (Vr)

Switching frequency (F) / Delay on pick-up (td)

LED indicator

Protection against permanent short-circuits and overloads

Protection against mis-connections of any type

Conductor cross-section / External cable diameter

84 718 024	84 718 036	84 718 030	84 718 042
84 718 026	84 718 038	84 718 032	84 718 044
10 to 40 V $\bar{=}$	10 to 40 V $\bar{=}$	10 to 40 V $\bar{=}$	10 to 40 V $\bar{=}$
200 mA	200 mA	200 mA	200 mA
0.05 mA / 7 mA	0.05 mA / 7 mA	0.05 mA / 7 mA	0.05 mA / 7 mA
< 2 V / < 10 %	< 2 V / < 10 %	< 2 V / < 10 %	< 2 V / < 10 %
300 Hz / 50 ms	300 Hz / 50 ms	100 Hz / 50 ms	100 Hz / 50 ms
yes	yes	yes	yes
yes	yes	yes	yes
yes	yes	yes	yes
4 x 0.3 mm ² / 5.2 mm	4 x 0.3 mm ² / 5.2 mm	4 x 0.3 mm ² / 5.2 mm	4 x 0.3 mm ² / 5.2 mm

Dimensions

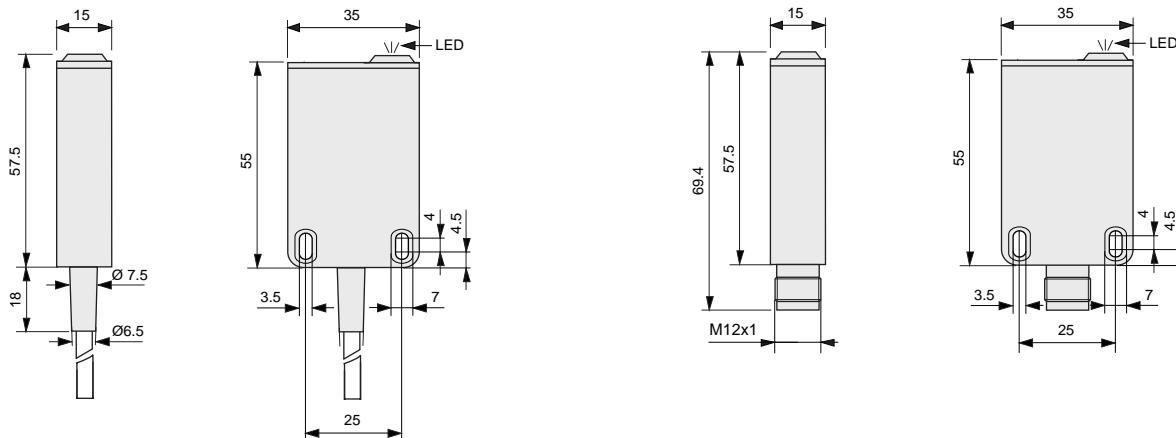

mm

Other information	To order, specify:			
Special adaptations are available depending on the type of request and quantity required. Eg. cable length, tube length, connector type, etc.	<table border="1"> <tr> <td>Standard products</td> <td rowspan="2"> 1 Part number Example : Inductive proximity detector 84 718 024 </td> </tr> <tr> <td>Standard products, non stocked</td> </tr> </table>	Standard products	1 Part number Example : Inductive proximity detector 84 718 024	Standard products, non stocked
Standard products	1 Part number Example : Inductive proximity detector 84 718 024			
Standard products, non stocked				

Products and specifications subject to change without notice.

Order/Technical Support – Tel: (800) 677-5311 / FAX: (800) 677-3865 / www.crouzet-usa.com

Inductive Proximity Detectors - 40 x 40

- 5-position rotary head
- Conform to DIN 43 694
- Reinforced glass polyamide housing
- 1 "on" LED
- 1 detection LED
- 4-wire NO and NC operation
- 2-wire ~ and --- version

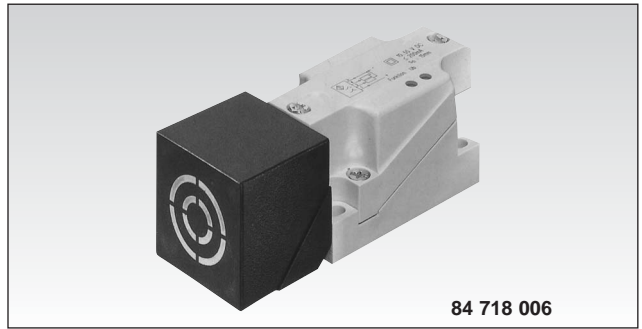

Form
Nominal sensing distance Sn (mm)
Housing
Tightening torque (Nm)
Termination

40 x 40 non-screened
25
Plastic
—
Screw terminal

Part numbers 1

4-wire DC types

PNP	NO / NC		
NPN	NO / NC		
Min/max. supply voltage			
Max. load current (Ia)			
Residual open-state current (I _r) / Own consumption (I _o)			
Voltage drop in closed state (U _d) / Max. ripple factor (V _r)			
Switching frequency (F) / Delay on pick-up (td)			
LED indicator			
Protection against permanent short-circuits and overloads			
Protection against mis-connections of any type			
Conductor cross-section / External cable diameter			

84 718 006
84 718 008
10 to 55 V ---
200 mA
< 0.05 mA / 25 mA
< 3.5 V / < 10 %
100 Hz / < 100 ms
yes - power supply and output
yes
yes
—

Part numbers

2-wire AC / DC types

Polarity reversible NO		or	NC		programmable
Min/max. supply voltage					
Max. load current (Ia)					
Residual open-state current (I _r)					
Voltage drop in closed state (U _d)					
Switching frequency (F) / Delay on pick-up (td)					
LED indicator					
Short-circuit protection					
Conductor cross-section					

84 718 010
20 to 250 V ~ / ---
5 to 180 mA
< 1.7 mA @ 120 V ~
< 10.5 V
100 Hz / 200 ms
yes - power supply and output
yes
—

Connections

84 718 006

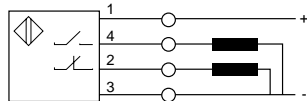

84 718 008

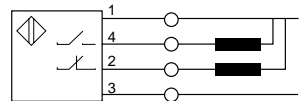

Dimensions (mm)

5-position rotary head

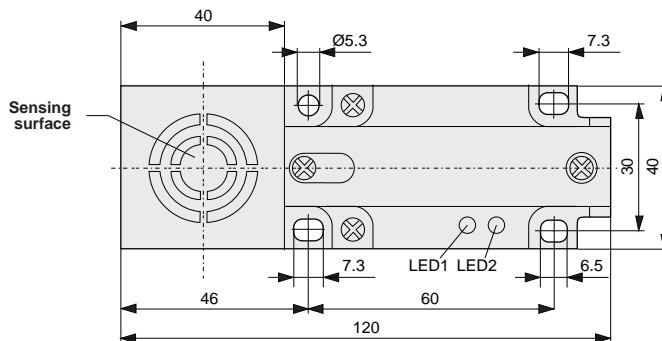

Other information	To order, specify:					
Special adaptations are available depending on the type of request and quantity required. Eg. cable length, tube length, connector type, etc.	<table border="0"> <tr> <td style="background-color: #cccccc; width: 20px;"></td> <td>Standard products</td> <td rowspan="2" style="vertical-align: middle;"> <div style="display: flex; align-items: center;"> <div style="background-color: #1a1a1a; color: white; padding: 2px 5px; margin-right: 5px;">1</div> Part number </div> Example : Inductive proximity detector 40 x 40 84 718 006 </td> </tr> <tr> <td style="background-color: #cccccc; width: 20px;"></td> <td>Standard products, non stocked</td> </tr> </table>		Standard products	<div style="display: flex; align-items: center;"> <div style="background-color: #1a1a1a; color: white; padding: 2px 5px; margin-right: 5px;">1</div> Part number </div> Example : Inductive proximity detector 40 x 40 84 718 006		Standard products, non stocked
	Standard products	<div style="display: flex; align-items: center;"> <div style="background-color: #1a1a1a; color: white; padding: 2px 5px; margin-right: 5px;">1</div> Part number </div> Example : Inductive proximity detector 40 x 40 84 718 006				
	Standard products, non stocked					

Products and specifications subject to change without notice.

Order/Technical Support – Tel: (800) 677-5311 / FAX: (800) 677-3865 / www.crouzet-usa.com

NAMUR Inductive Proximity Detectors (Acc. DIN 19234) M8 - M12

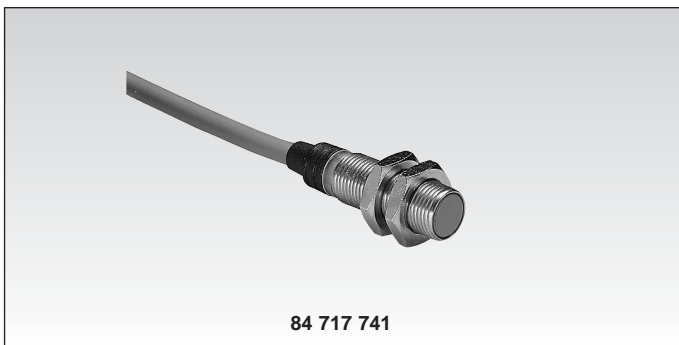

84 717 741

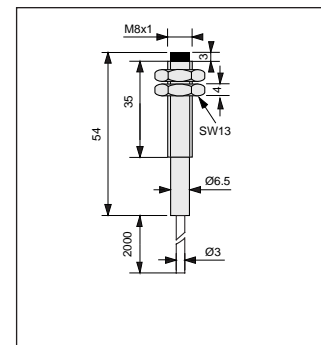
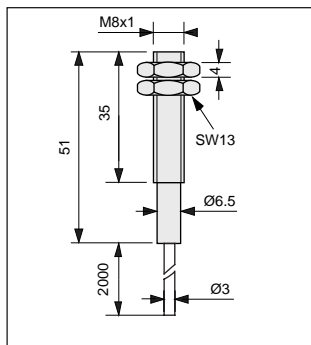

Form
Nominal sensing distance Sn (mm)
Housing
Tightening torque (Nm)
Termination

M8 screened
1
Stainless steel
2 m PVC cable

M8 non-screened
2
Stainless steel
2 m PVC cable

Part numbers

2-wire DC NAMUR types
NC
Min/max. supply voltage
ON state current with V supply=8.2 V
OFF state current with V supply=8.2 V
Current at specified Sn with V supply=8.2 V
Max. current (Ia)
Switching frequency (F)
Conductor cross-section / External cable diameter

84 717 707
6 to 35 V $\overline{\text{---}}$
< 1 mA
> 2.2 mA
1.55 mA
9.35 mA
2 kHz
2 x 0.14 mm ² / 3 mm

84 717 709
6 to 35 V $\overline{\text{---}}$
< 1 mA
> 2.2 mA
1.55 mA
9.35 mA
1.5 kHz
2 x 0.14 mm ² / 3 mm

Accessories

Mounting flanges, see page 3/102
Connectors, see page 3/100 to 3/101

NAMUR Inductive Proximity Detectors (Acc. DIN 19234) M18 - M30

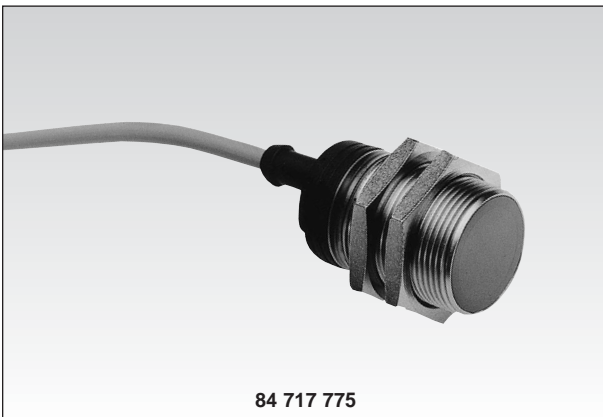

84 717 775

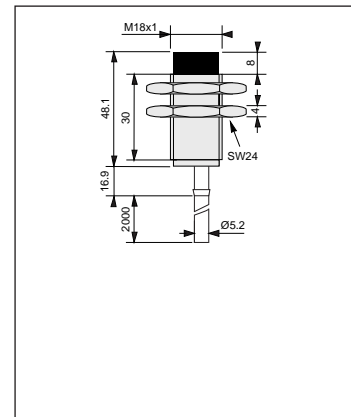
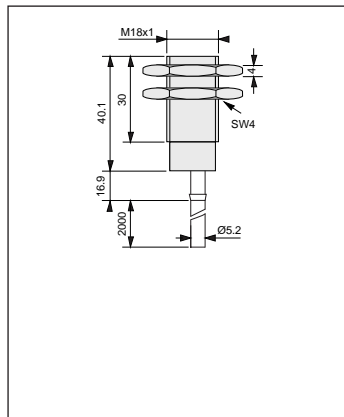

Form
Nominal sensing distance Sn (mm)
Housing
Tightening torque (Nm)
Termination

M18 screened
5
Stainless steel
2 m PVC cable *M12 plastic connector

M18 non-screened
5
Stainless steel
2 m PVC cable *M12 plastic connector

Part numbers

2-wire DC NAMUR types
NC
Min/max. supply voltage
ON state current with V supply=8.2 V
OFF state current with V supply=8.2 V
Current at specified Sn with V supply=8.2 V
Max. current (Ia)
Switching frequency (F)
Conductor cross-section / External cable diameter

84 717 755 *84 717 767
6 to 35 V $\overline{\text{---}}$
< 1 mA
> 2.2 mA
1.55 mA
9.35 mA
500 Hz
2 x 0.5 mm ² / 5.2 mm

84 717 757 *84 717 769
6 to 35 V $\overline{\text{---}}$
< 1 mA
> 2.2 mA
1.55 mA
9.35 mA
200 Hz
2 x 0.5 mm ² / 5.2 mm

Accessories

Mounting flanges, see page 3/102
Connectors, see pages 3/100 to 3/101.

Other information

Special adaptations are available depending on the type of request and quantity required. Eg. cable length, tube length, connector type, etc.

Products and specifications subject to change without notice.

Order/Technical Support – Tel: (800) 677-5311 / FAX: (800) 677-3865 / www.crouzet-usa.com

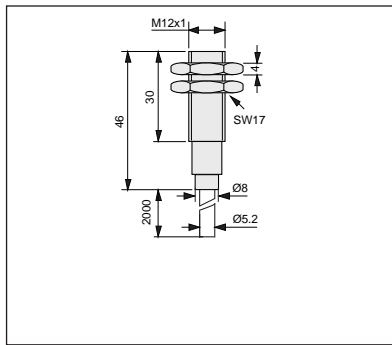

M12 screened
2
Stainless steel
2 m PVC cable *M12 plastic connector

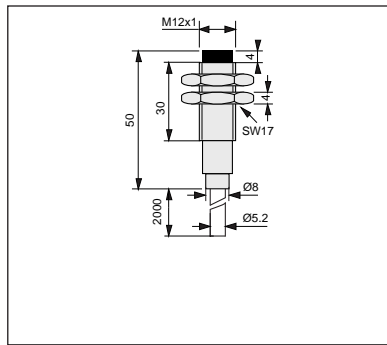

M12 non-screened
4
Stainless steel
2 m PVC cable *M12 plastic connector

1

84 717 731	*84 717 743
6 to 35 V $\overline{\text{---}}$	6 to 35 V $\overline{\text{---}}$
< 1 mA	< 1 mA
> 2.2 mA	> 2.2 mA
1.55 mA	1.55 mA
9.35 mA	9.35 mA
800 Hz	800 Hz
2 x 0.5 mm ² / 5.2 mm	2 x 0.5 mm ² / 5.2 mm

84 717 733	*84 717 745
6 to 35 V $\overline{\text{---}}$	6 to 35 V $\overline{\text{---}}$
< 1 mA	< 1 mA
> 2.2 mA	> 2.2 mA
1.55 mA	1.55 mA
9.35 mA	9.35 mA
800 Hz	800 Hz
2 x 0.5 mm ² / 5.2 mm	2 x 0.5 mm ² / 5.2 mm

3

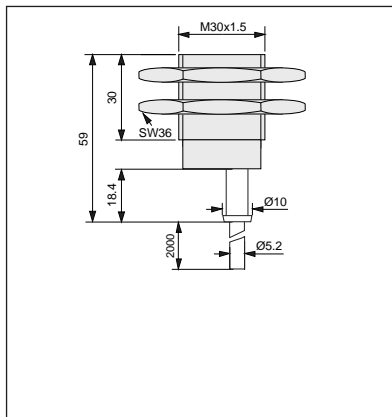

M30 screened
10
Stainless steel
2 m PVC cable *M12 plastic connector

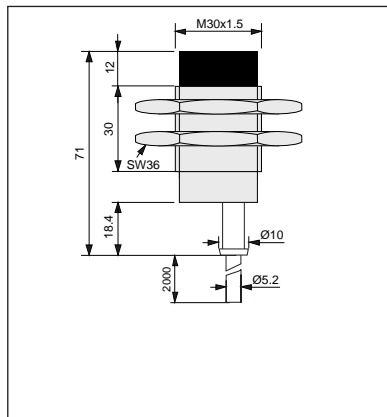

M30 non-screened
15
Stainless steel
2 m PVC cable *M12 plastic connector

1

84 717 779	*84 717 791
6 to 35 V $\overline{\text{---}}$	6 to 35 V $\overline{\text{---}}$
< 1 mA	< 1 mA
> 2.2 mA	> 2.2 mA
1.55 mA	1.55 mA
9.35 mA	9.35 mA
300 Hz	300 Hz
2 x 0.5 mm ² / 5.2 mm	2 x 0.5 mm ² / 5.2 mm

84 717 781	*84 717 793
6 to 35 V $\overline{\text{---}}$	6 to 35 V $\overline{\text{---}}$
< 1 mA	< 1 mA
> 2.2 mA	> 2.2 mA
1.55 mA	1.55 mA
9.35 mA	9.35 mA
100 Hz	100 Hz
2 x 0.5 mm ² / 5.2 mm	2 x 0.5 mm ² / 5.2 mm

To order, specify:

Standard products, non stocked **1** Part number
Example : Inductive proximity detector M8 84 717 707

Products and specifications subject to change without notice.

Order/Technical Support – Tel: (800) 677-5311 / FAX: (800) 677-3865 / www.crouzet-usa.com

Inductive Proximity Detectors for Severe Environments

- Inductive detector for severe environments
- Operating range : - 55 °C to + 105 °C
- Conforms with standards :
 - EUROCAE ED 14 C
 - MIL STD



Nominal sensing distance S_n (mm)

Material Housing
Face

Termination

Part numbers

3-wire DC types

NPN NO 
NC 

Min/max. supply voltage

Switching current

Max. off-load current consumption

Residual voltage at 25 °C

Switching frequency

Termination

Sealing (MIL - S - 8 805)

Protection against mis-connections of any type
against accidental voltage surges of short duration
against indirect lightning effects
against radio-electrical interference

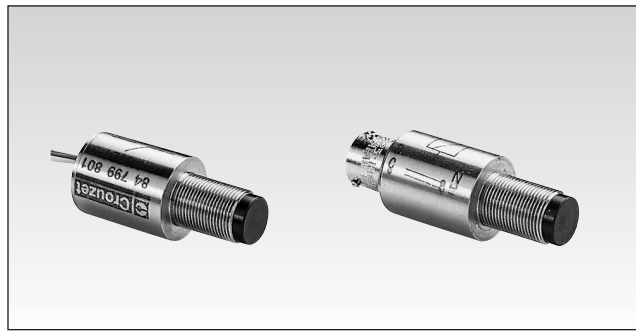

2.5 ±0.25

Stainless steel

Rilsan

1m wire

2.5 ±0.25

Stainless steel

Rilsan

Connector

1

84 799 801

84 799 802

12 to 32 V $\bar{\text{---}}$

1 to 250 mA resistive

8 mA

2V 250 mA

250 Hz

3 x 0.6 mm² wires

Dust

yes

yes

yes

yes

84 799 803

84 799 804

12 to 32 V $\bar{\text{---}}$

1 to 250 mA resistive

8 mA

2V 250 mA

250 Hz

Type ASN E0053 N8133PN

Immersion in water

yes

yes

yes

yes

Inductive Proximity Detectors NAMUR (Acc. DIN 19234)

Operating principle

NAMUR sensors (DIN 19234) are 2-wire DC proximity detectors with no trip or output amplification stage. They are polarised and their internal impedance alters in proportion to the distance between the sensor face and the target. NAMUR sensors are designed for use with an external amplifier which converts the variations in impedance into digital signals.

Output characteristics

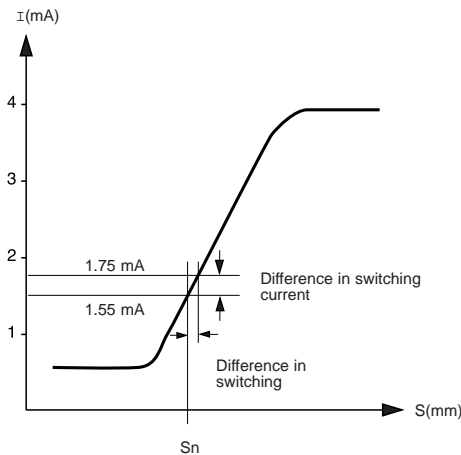

Wiring diagrams

Without external amplifier

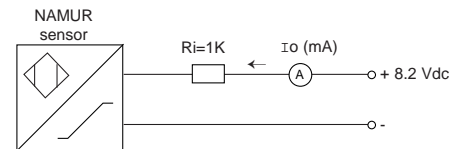

With external amplifier

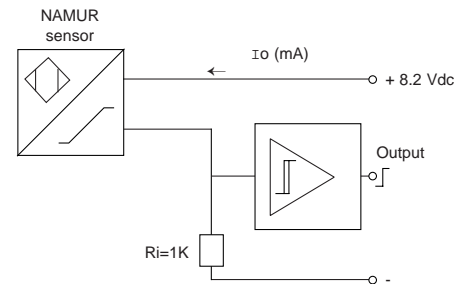

The nominal sensing range (S_n) specified corresponds to a current consumption of 1.55 mA with a supply voltage of 8.2 V to the circuit and $R_i = 1$ Kohm. The table below gives the level of current consumption at nominal sensing range (S_n) for other supply voltage and resistance values.

Supply voltage V (Vdc)	Resistance R_i (Kohm)	Current consumption I at S_n (mA)
5		
12	0.39	0.7
15	1.8	2.3
24	2.2	2.9
	3.9	3.8

To order, specify :

Standard products, non stocked

1 Part number

Example : Inductive proximity detector 84 799 801

Products and specifications subject to change without notice.

Order/Technical Support – Tel: (800) 677-5311 / FAX: (800) 677-3865 / www.crouzet-usa.com

Capacitive Proximity Detectors - M18 - M30

- Smooth body : ideally suited to agricultural applications

M18

- Sensing distance adjustable from 2 mm to 10 mm

M30

- Fixed sensing distance of 9 mm
- Application
Level detection : liquids, granulates, paper, ink, etc.

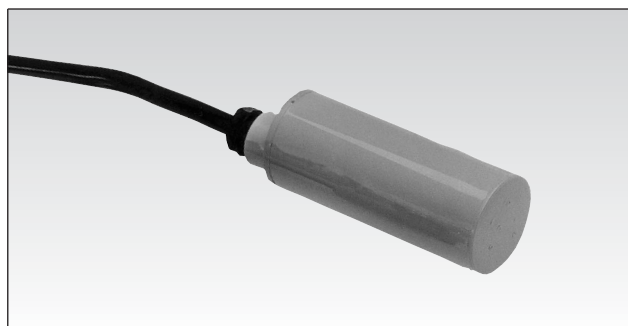

Form

Nominal sensing distance Sn (mm)

Housing

Tightening torque (Nm)

Termination

M18 non-screened
2 to 10 mm adjustable
Plastic

Ø30 non-screened
9 (fixed)
Plastic

2 m PVC cable

2 m PVC cable

Part numbers

3-wire DC types

PNP NO

NPN NO

Min/max. supply voltage

Max. load current (Ia)

Residual open-state current (Ir) / Own consumption (Io)

Voltage drop in closed state (Ud) / Max. ripple factor (Vr)

Switching frequency (F) / Delay on pick-up (td)

LED indicator

Protection against permanent short-circuits and overloads

Protection against mis-connections of any type

Conductor cross-section / External cable diameter

84 718 506

84 718 508

10 to 40 V \pm

200 mA

< 0.05 mA / < 10 mA

< 2.8 V \pm / < 10 %

25 Hz / < 100 ms

yes

yes

yes

3 x 0.25 mm² / 5.2 mm

Part numbers

2-wire AC types

Polarity NO

reversible NC

Min/max. supply voltage

Min/max. load current (Ia)

Residual open-state current (Ir)

Voltage drop in closed state (Ud)

Switching frequency (F) / Delay on pick-up (td)

LED indicator

Conductor cross-section

84 718 510

84 718 511

20 to 265 V \sim

10 to 500 mA

< 2.6 mA

< 10 V

10 Hz / < 350 ms

yes

2 x 0.5 mm² / 5.2 mm

84 718 588

84 718 589

90 to 240 V \sim

20 to 150 mA

< 10 mA

< 11 V

5 Hz /

no

2 x 0.75 mm² / 5.2 mm

Accessories

Mounting flanges, see page 3/102

Dimensions (mm)

84 718 506 / 508
84 718 510 / 511

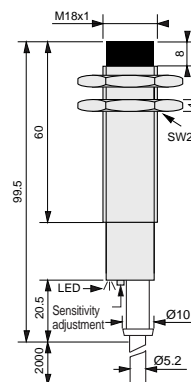

84 718 588 / 589

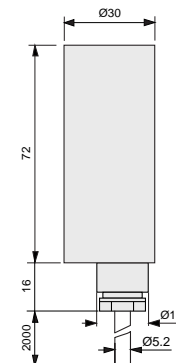

Other information	To order, specify:		
Special adaptations are available depending on the type of request and quantity required. Eg. cable length.			
	<table border="0"> <tr> <td style="background-color: #cccccc;">Standard products</td> <td>1 Part number Example : Capacitive proximity detector M18 84 718 506</td> </tr> </table>	Standard products	1 Part number Example : Capacitive proximity detector M18 84 718 506
Standard products	1 Part number Example : Capacitive proximity detector M18 84 718 506		

Products and specifications subject to change without notice.

Order/Technical Support – Tel: (800) 677-5311 / FAX: (800) 677-3865 / www.crouzet-usa.com

Capacitive Proximity Detectors - Flat Pack

- 4-wire NO and NC operation
- Easy to mount : only 2 M 3.5 screws required
- Ideal for packaging machine applications
- Inductive detection version available in same housing
- Supplied with adjustment screwdriver



Form	
Nominal sensing distance Sn (mm)	non-screened mounting : screened mounting :
Housing	
Tightening torque (Nm)	
Termination	

55 x 35 non-screened / screened	55 x 35 non-screened / screened
2 - 25 mm adjustable	2 - 25 mm adjustable
2 - 16 mm adjustable	2 - 16 mm adjustable
Plastic	Plastic
2 m PVC cable	M12 connector

Part numbers

4-wire DC types

PNP	NO + NC	
NPN	NO + NC	
Min/max. supply voltage		
Max. load current (Ia)		
Residual open-state current (Ir) / Own consumption (Io)		
Voltage drop in closed state (Ud) / Max. ripple factor (Vr)		
Switching frequency (F) / Delay on pick-up (td)		
LED indicator		
Protection against permanent short-circuits and overloads		
Protection against mis-connections of any type		
Conductor cross-section / External cable diameter		

84 718 572	84 718 578
84 718 574	84 718 580
10 to 40 V $\bar{\bar{=}}$	10 to 40 V $\bar{\bar{=}}$
200 mA	200 mA
< 0.05 mA / < 15 mA	< 0.05 mA / < 15 mA
< 3 V $\bar{\bar{=}}$ / < 10 %	< 3 V $\bar{\bar{=}}$ / < 10 %
100 Hz / < 300 ms	100 Hz / < 300 ms
yes	yes
yes	yes
yes	yes
4 x 0.35 mm ² / 6.8 mm	—

Dimensions (mm)

84 718 572 / 574

84 718 578 / 580

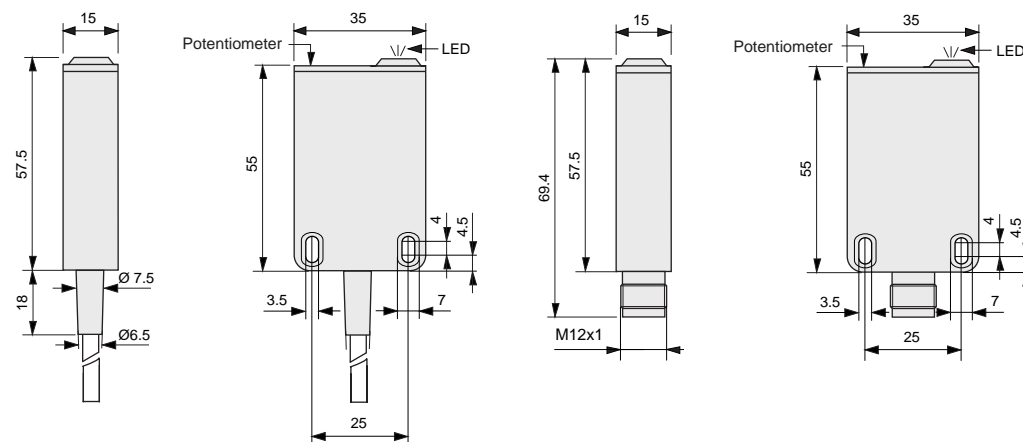

Other information	To order, specify:				
Special adaptations are available depending on the type of request and quantity required. Eg. cable length.	<table border="0"> <tr> <td></td> <td>Standard products</td> </tr> <tr> <td></td> <td>Standard products, non stocked</td> </tr> </table>		Standard products		Standard products, non stocked
	Standard products				
	Standard products, non stocked				
	<p>1 Part number</p> <p>Example : Capacitive proximity detector Flat pack 84 718 572</p>				

Products and specifications subject to change without notice.

Order/Technical Support – Tel: (800) 677-5311 / FAX: (800) 677-3865 / www.crouzet-usa.com

Capacitive Proximity Detectors - M30

- Programmable model
- Selection via switch
- NO and NC output
- Supplied with adjustment screwdriver
- EMC immunity : 10 V/ m

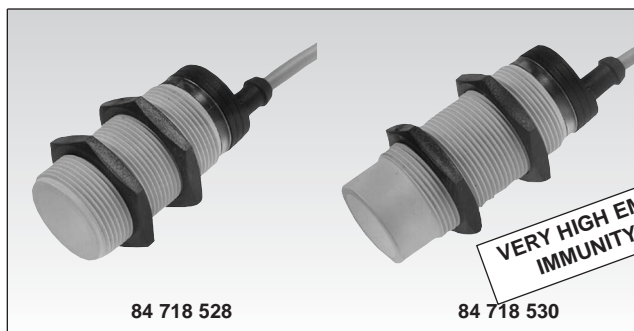

Form
Nominal sensing distance Sn (mm) - adjustable
Housing
 Tightening torque (Nm)
 Termination

M30 screened	M30 non-screened
2 to 16 mm adjustable	3 to 25 mm adjustable
Plastic	Plastic
2 m PVC cable	2 m PVC cable

Part numbers 1

4-wire DC types

PNP NO + NC +

NPN NO + NC +

Min/max. supply voltage
 Max. load current (Ia)
 Residual open-state current (Ir) / Own consumption (Io)
 Voltage drop in closed state (Ud) / Max. ripple factor (Vr)
 Switching frequency (F) / Delay on pick-up (td)
 Annular LED
 Protection against permanent short-circuits and overloads
 Protection against mis-connections of any type
 Conductor cross-section / External cable diameter

84 718 524	84 718 530
84 718 526	84 718 532
10 to 40 V ---	10 to 40 V ---
200 mA	200 mA
0.05 mA / 10 mA	0.05 mA / 10 mA
2.5 V / < 10 %	2.5 V / < 10 %
100 Hz / < 100 ms	100 Hz / < 100 ms
yes	yes
yes	yes
yes	yes
4 x 0.34 mm ² / 6.8 mm	4 x 0.34 mm ² / 6.8 mm

Part numbers 1

2-wire AC types

Polarity reversible NO or NC or

programmable

Min/max. supply voltage
 Min/max. load current (Ia)
 Residual open-state current (Ir)
 Voltage drop in closed state (Ud)
 Switching frequency (F) / Delay on pick-up (td)
 Annular LED

84 718 528	84 718 534
20 to 265 V \sim	20 to 265 V \sim
10 to 500 mA	10 to 500 mA
2.5 mA @ 240 V \sim	2.5 mA @ 240 V \sim
10 V \sim	10 V \sim
25 Hz / < 100 ms	25 Hz / < 100 ms
yes	yes
2 x 0.5 mm ² / 5.2 mm	2 x 0.5 mm ² / 5.2 mm

Accessories

Mounting flanges, see page 3/102

Dimensions (mm)

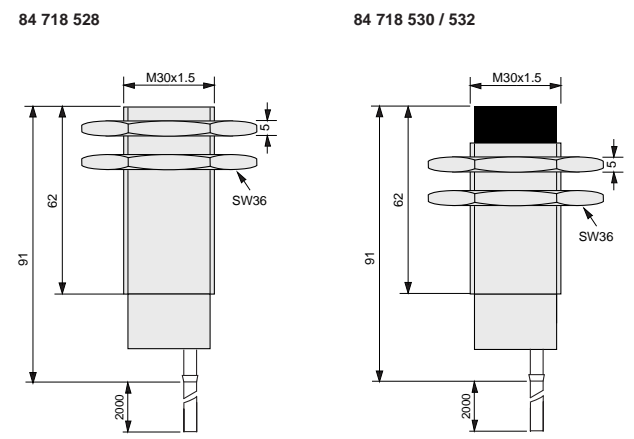

Other information	To order, specify :
Special adaptations are available depending on the type of request and quantity required. Eg. cable length.	<div style="display: flex; align-items: center;"> <div style="width: 20px; height: 10px; background-color: #ccc; margin-right: 5px;"></div> Standard products </div> <div style="display: flex; align-items: center; margin-top: 10px;"> <div style="width: 20px; height: 10px; background-color: #ccc; margin-right: 5px;"></div> Standard products, non stocked </div> <div style="margin-left: 20px;"> <p>1 Part number</p> <p>Example : Capacitive proximity detector M30 84 718 524</p> </div>

Products and specifications subject to change without notice.

Order/Technical Support – Tel: (800) 677-5311 / FAX: (800) 677-3865 / www.crouzet-usa.com

Connectors for V3 and M8 Detectors (with M8 Connector)

M8 plug-in versions

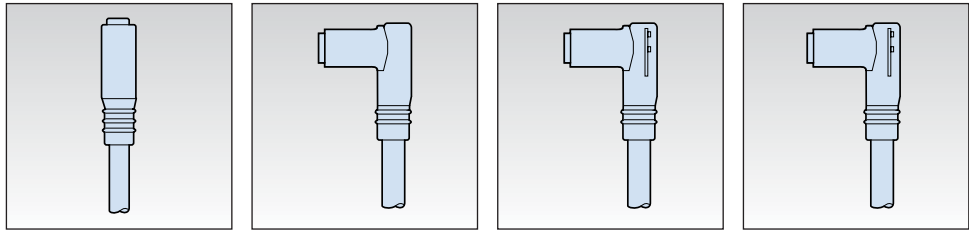

Presentation	Straight, no LED	Angled, no LED	Angled, 2 LEDs (PNP)	Angled, 2 LEDs (NPN)
Number of contacts	3	3	3	3

Part numbers

Length 2 m	PVC	25 552 953	25 552 955	25 552 957	25 552 958
Length 5 m	PVC	25 552 954	25 552 956	—	—
Compatibility		V3 and M8 detectors with M8 connector and PNP - NO/NC or NPN - NO/NC output		V3 and M8 detectors with M8 connector and PNP - NO/NC output	V3 and M8 detectors with M8 connector and NPN - NO/NC output
Display via LED	Power supply Output activated	—	—	Green Yellow	Green Yellow

1

M8 screw-in versions

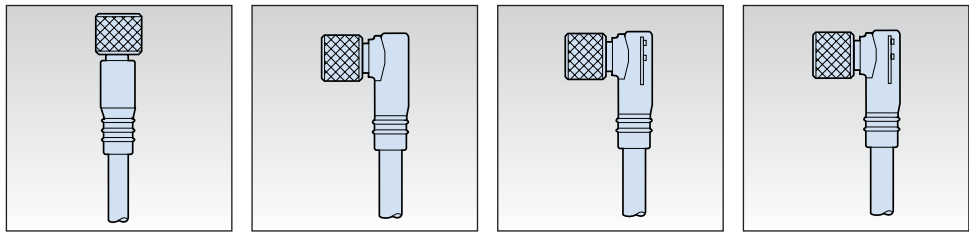

Presentation	Straight, no LED	Angled, no LED	Angled, 2 LEDs (PNP)	Angled, 2 LEDs (NPN)
Number of contacts	3	3	3	3

Part numbers

Length 2 m	PVC	25 552 959	25 552 961	25 552 963	25 552 965
Length 5 m	PVC	25 552 960	25 552 962	25 552 964	25 552 966
Compatibility		M8 detectors with M8 connector and PNP - NO/NC or NPN - NO/NC output		M8 detectors with M8 connector and PNP - NO/NC output	M8 detectors with M8 connector and NPN - NO/NC output
Display via LED	Power supply Output activated	—	—	Green Yellow	Green Yellow

1

General characteristics

Sealing	Plug-in versions	Screw-in versions
Conductor cross-section	IP 65	IP 68
Limit temperature	3 x 0.25 mm ²	3 x 0.25 mm ²
Min/max supply for connectors with LED	-5 °C to + 70 °C	-5 °C to + 70 °C
	10 to 30 V =	10 to 30 V =

Connector pin-out

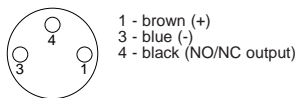

Connections

3-wire DC

3-wire = PNP

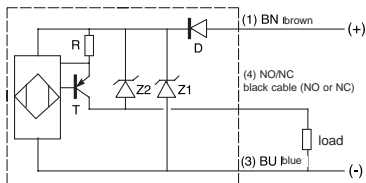

PNP output : load connected to negative supply

3-wire = NPN

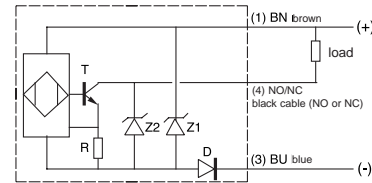

NPN output : load connected to positive supply

To order, specify :

Standard products

1 Part number

Example : Connector, plug-in version M8 25 552 953

Standard products, non stocked

Products and specifications subject to change without notice.

Order/Technical Support – Tel: (800) 677-5311 / FAX: (800) 677-3865 / www.crouzet-usa.com

Connectors for Detectors M8 - M12 - M18 - M30 and 35 x 55 mm (with Connector M12)

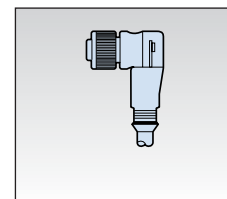
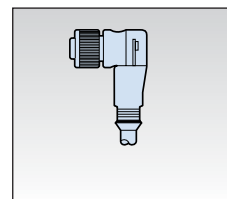
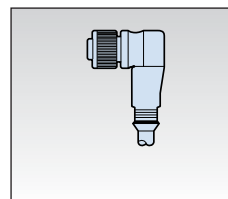
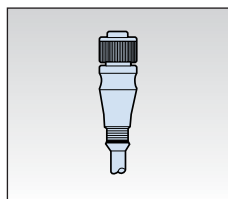

Presentation	Straight, no LED	Angled, no LED	Angled, 2 LEDs (PNP)	Angled, 2 LEDs (NPN)
Number of contacts	3	3	3	3

Part numbers

Length 2 m PVC	25 552 967	25 552 969	25 552 971	25 552 973
Length 5 m PVC	25 552 968	25 552 970	25 552 972	25 552 974

Compatibility	3-wire $\ddot{=}$ detectors with M12 connector and NO output 2-wire $\ddot{=}$ detectors with M12 connector and NO/NC output	3-wire $\ddot{=}$ detectors with M12 connector and PNP - NO output	3-wire $\ddot{=}$ detectors with M12 connector and NPN - NO output
---------------	---	--	--

Double key for AC model

Length 2 m PVC	25 552 989	25 552 991
Length 5 m PVC	25 552 990	25 552 992

Compatibility	2-wire detectors \sim polarity reversible with M12 connector	
---------------	--	--

Display via LED	Power supply	—	—	Green	Green
	Output activated	—	—	Yellow	Yellow

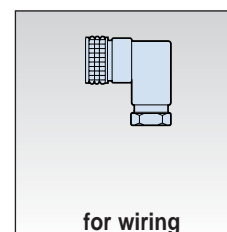
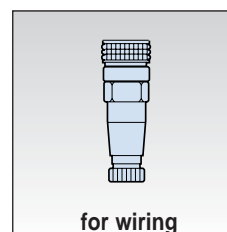
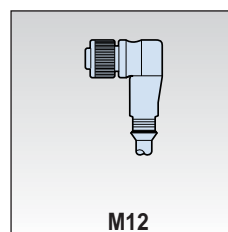
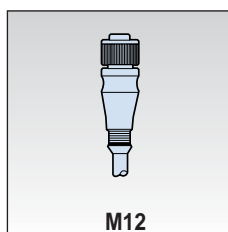

Presentation	Straight, no LED	Angled, no LED	Straight, no LED	Angled, no LED
Number of contacts	4	4	4	4

Part numbers

Screw terminal	—	—	25 552 983	25 552 984
Length 2 m PVC	25 552 975	25 552 979	—	—
Length 5 m PVC	25 552 976	25 552 980	—	—
Length 2 m PUR	25 552 977	25 552 981	—	—
Length 5 m PUR	25 552 978	25 552 982	—	—

Compatibility	Detectors with M12 connector NO, NC or NO and NC output			
---------------	---	--	--	--

General characteristics

Sealing	IP 68 (IP 67 versions for wiring)
Conductor cross-section	3 x 0.34 mm ² or 4 x 0.34 mm ²
Limit temperature	-5 °C to +70 °C (PUR -5 °C to +90 °C)
Min/max supply for connectors with LED	10 to 30 V $\ddot{=}$

Connector pin-out

Version with 3 contacts :
for $\ddot{=}$ detector

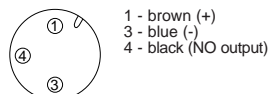

Version with 4 contacts :
for $\ddot{=}$ detector

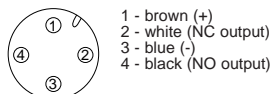

M12 double key version :
for \sim detector

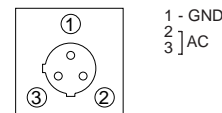

Connections

2-wire DC

Polarity reversible

2-wire $\ddot{=}$

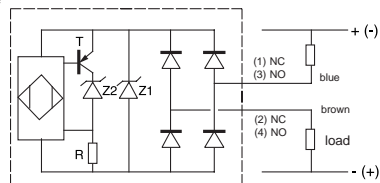

2-wire AC

Polarity reversible

2-wire \sim

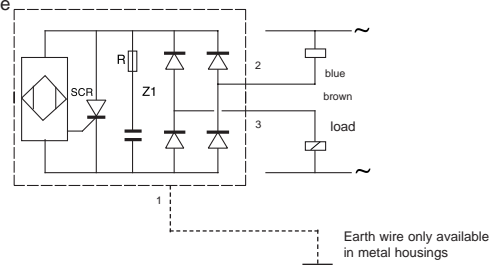

Earth wire only available in metal housings

To order, specify :

Standard products

1 Part number

Example : Connector for M12 detector - 25 552 967

Standard products, non stocked

Products and specifications subject to change without notice.

Order/Technical Support – Tel: (800) 677-5311 / FAX: (800) 677-3865 / www.crouzet-usa.com

Mounting Flanges for Inductive Proximity Detectors

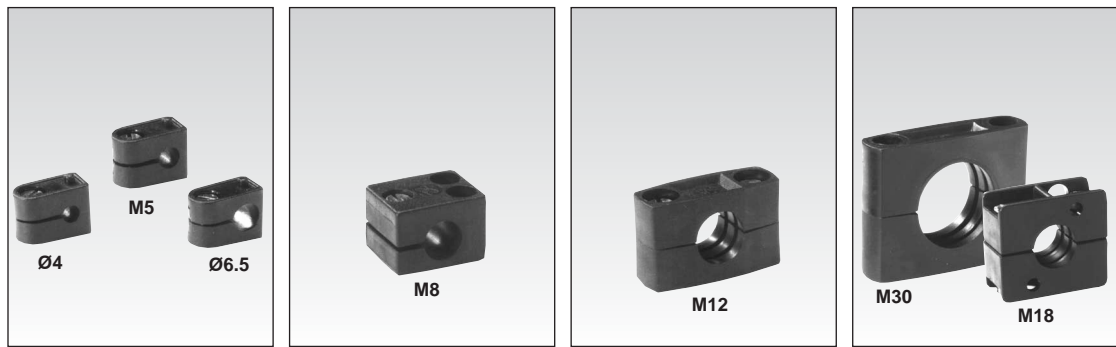

1

Part numbers

Mounting flange				
Ø 4	26 546 820			
M5	26 546 821			
Ø 6.5	26 546 822			
M8		26 546 823		
M12			26 546 824	
M18				26 546 825
M30				26 546 826

Dimensions

Flange for Ø4 - M5 - Ø6.5

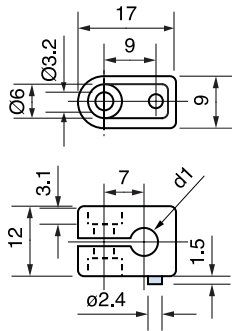

Flange for M8

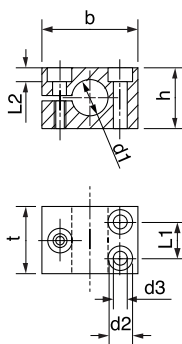

Flange for M12 and M30

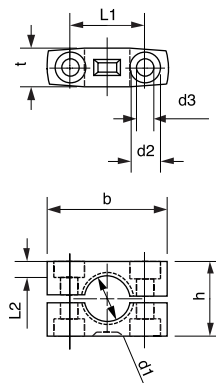

Flange for M18

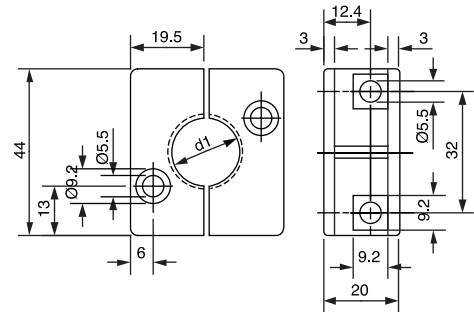

d1	d2	d3	L1	L2	b	h	t
M 8	6.0	3.2	7.5	3.3	20	14	16
M12	8	4.5	22	4.5	32	20	12
M 18	9.2	5.5	32	—	44	39	20
M 30	10	6	44	7.5	60	48.5	17

To order, specify :

Standard products

1 Part number

Example : Mounting flange Ø 4 - 26 546 820

Products and specifications subject to change without notice.

Order/Technical Support – Tel: (800) 677-5311 / FAX: (800) 677-3865 / www.crouzet-usa.com

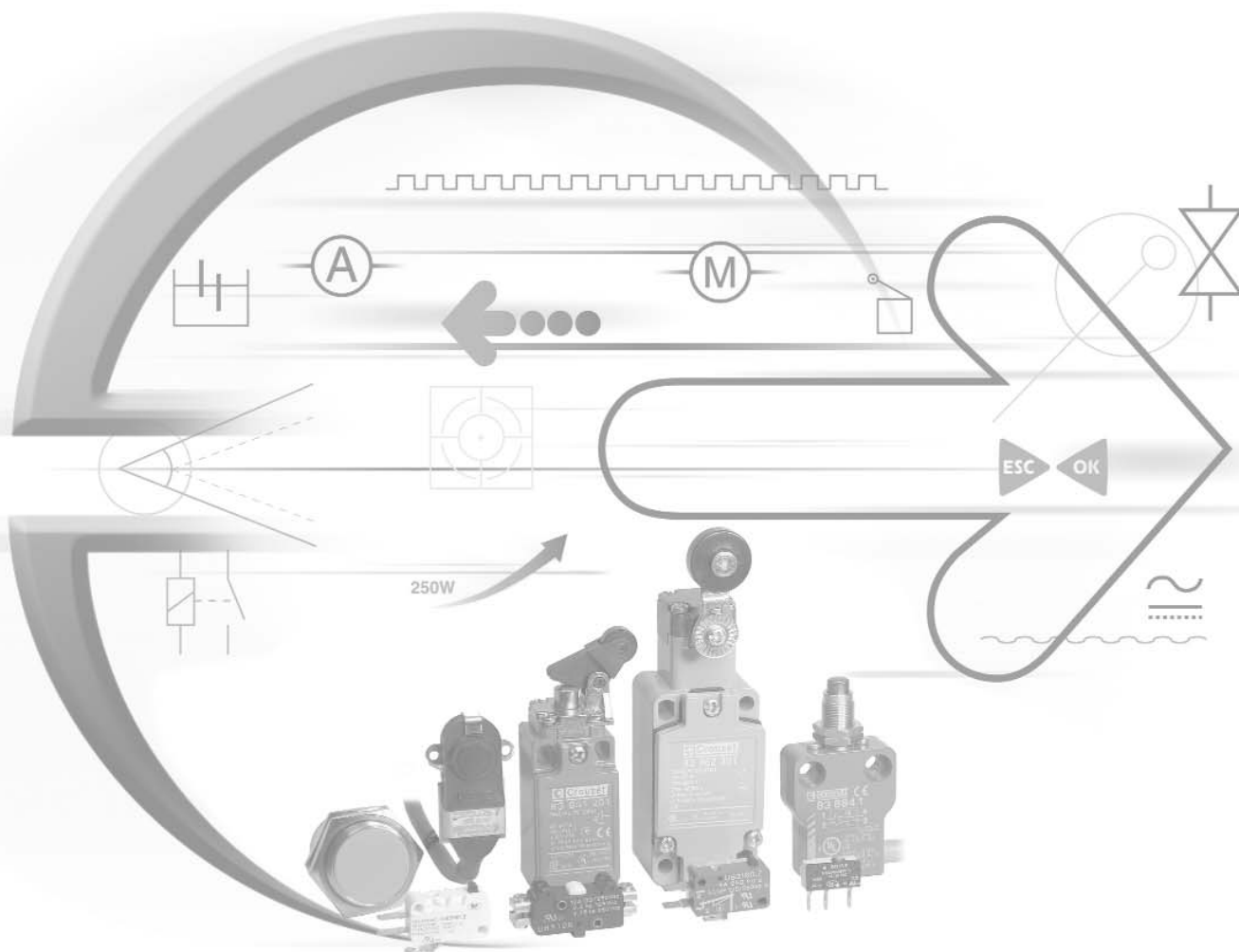

Technical References



Products and specifications subject to change without notice.

Order/Technical Support – Tel: (800) 677-5311 / FAX: (800) 677-3865 / www.crouzet-usa.com

Introduction

These basic principles apply to all our precision switches. The specific characteristics of each model are given in more detail in the relevant production sections.

Introduction

Our switches are high-precision, snap-action switches and these are a few of the key features which distinguish our switches:

- High ratings with small dimensions
- Very short travels
- Low operating forces
- Highly dependable force and travel values
- Long life
- Large range of actuators for easy adaptation to the most varied applications

Switch construction

Single-pole changeover switch (i.e. 83 161)

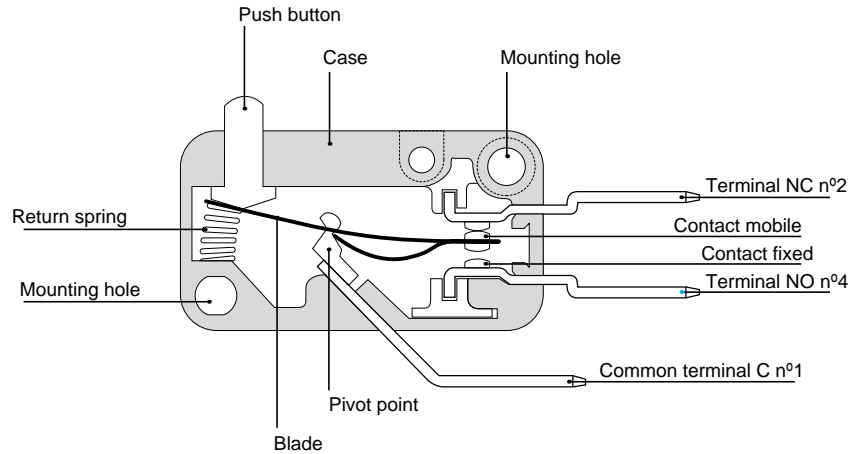

Electrical function SPDT (C)



Normally closed (NC)



Normally open (NO)



Double-pole changeover switch (i.e. 83 132 0)

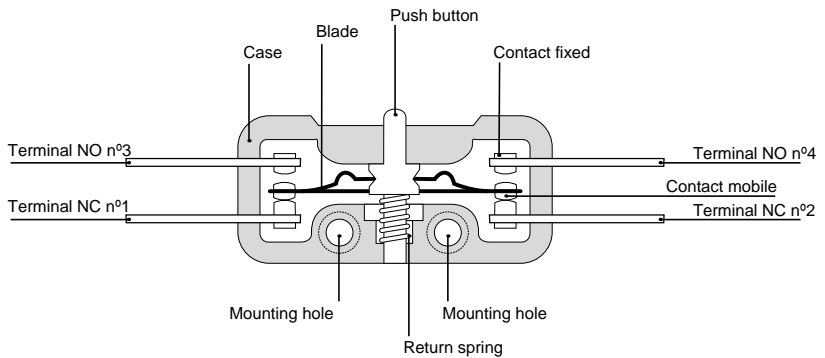

Electrical function SPDT (C)



Normally closed (NC)



Normally open (NO)



The NO and NC circuits must both be of the same polarity.

Products and specifications subject to change without notice.

Order/Technical Support – Tel: (800) 677-5311 / FAX: (800) 677-3865 / www.crouzet-usa.com

Mechanical characteristics

Terminology - Forces - Positions - Travel

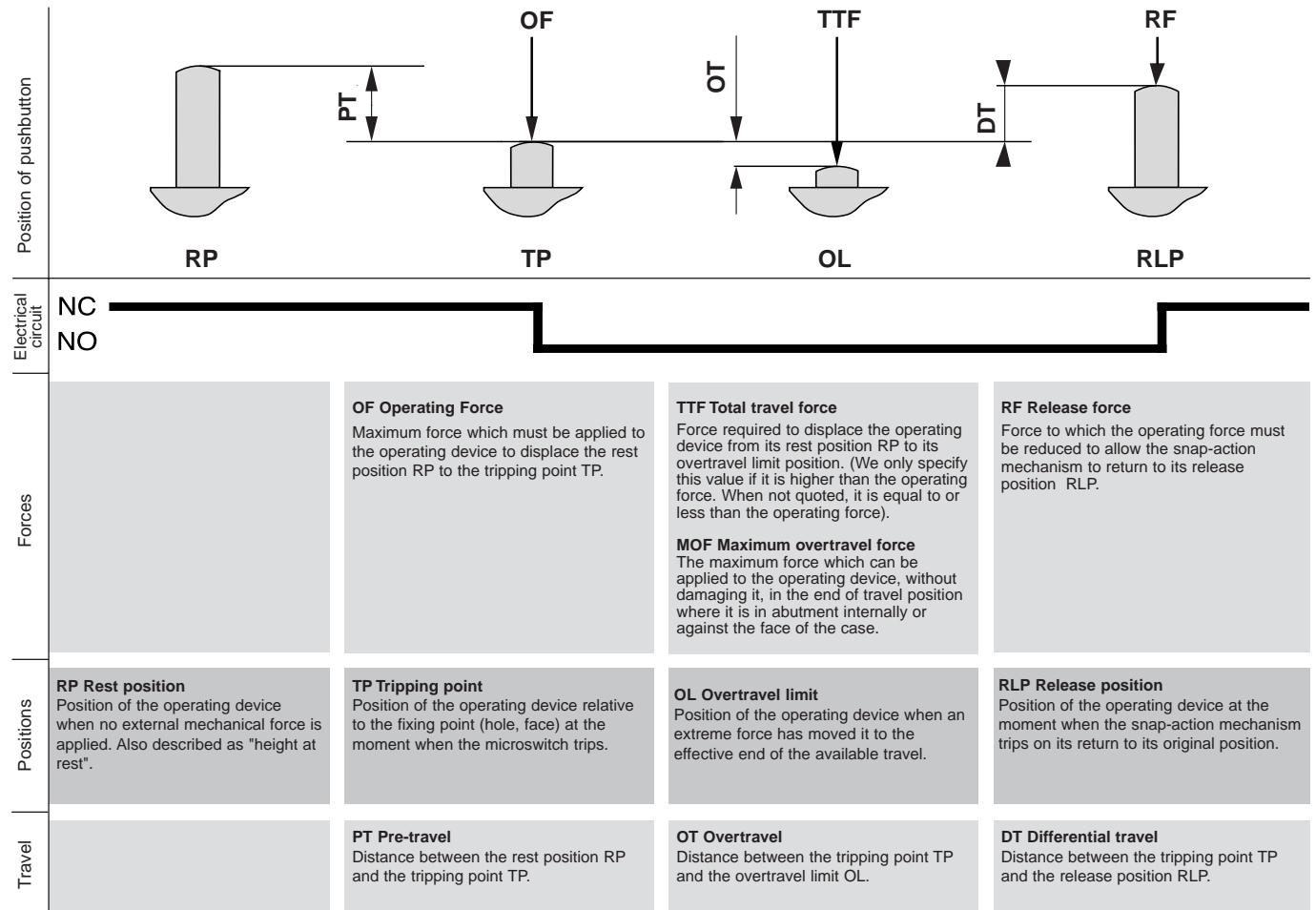

The reference point for the figures given for travel and forces is a point F situated on the button in the case of a plain microswitch, or, generally, 3 mm in from the end of a plain actuator. The reference point for the positions is one of the fixing holes, unless otherwise indicated.

Graphs of forces vs. travel

Operating force (external) applied to the operating device

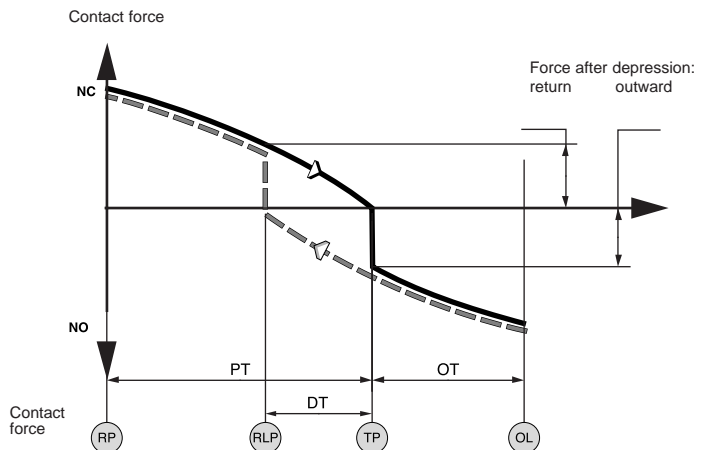
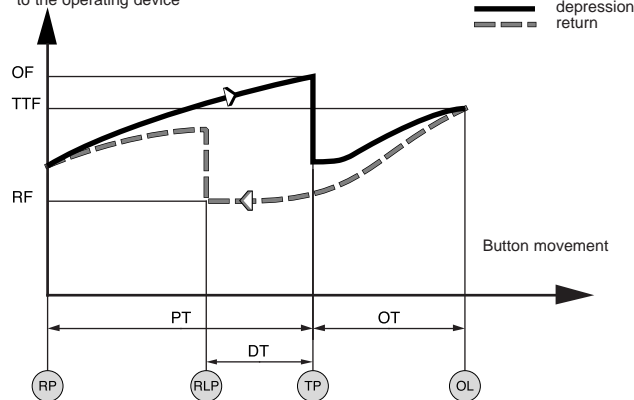

Products and specifications subject to change without notice.

Order/Technical Support – Tel: (800) 677-5311 / FAX: (800) 677-3865 / www.crouzet-usa.com

Mechanical characteristics

Changeover time

This is the time taken by the mobile contact when moving from one fixed contact to another until it becomes fully stable (contact bounce included). This time is a function of the contact gap, the mechanical characteristics of the snap action and the mass of the mobile element. However, thanks to the snap-action mechanisms employed, the time is largely independent of the speed of operation. It is normally less than 20 milliseconds (including bounce times of less than 5 ms).

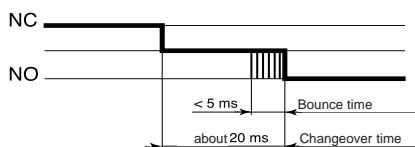

Mechanical durability

This is an average value indicating the purely mechanical performance of a switch when not subject to any electrical load. It may be useful for evaluation purposes in cases where the power levels involved are very low and the electrical life is thus close to the mechanical life.

Maximum speed and rate of operation

Our switches will work at speeds of operation varying over a very wide range : normally from 1 mm/min to 1 ms. The maximum rate of operation with a low electrical load may be as high as 10 operations/second.

Mounting - Operation

- To conform to the leakage paths and air gaps in the standard EEC24 - EN/IEC 61058 - EN/IEC 60947:
- An insulation pad must be inserted between the switch and the fixing surface if the latter is metal.
- Manual operation of a metal actuator must only be carried out with the help of a secondary actuator made of insulating materials.
- The installer must ensure adequate protection against direct contact with the output terminals.

Fixing - Screw torque

- Unless otherwise indicated in the mechanical characteristics table, the torque required for the fixing screws must conform to the following values :

Ø of fixing screw	2	2.5	3	3.5	4	
Screw torque in cm.N	maximum	25	35	60	100	150
	minimum	15	25	40	60	100

Environmental conditions

Resistance to shocks and vibrations

Resistance to impact and vibration depends on the mass of the moving parts and on the forces holding the contacts together.

Generally speaking, for a switch without an actuator :

- Vibration >10 G 10 at 500 Hz
 - Impact > 50 G 11 ms 1/2 sine-wave
- Further information on request.

Ambient operating temperature

The maximum and minimum temperatures at which the mechanical and electrical characteristics of the switch will remain substantially unaltered.

Degree of protection

Under the IEC 529 or NFC 20010 classification scheme, standards employ an IP code to define the degree or class of protection which electrical equipment provides against access to live components, the entry of solid foreign bodies and ingress of water.

1st numeral	
Protection equipment provides against the entry of solid foreign bodies	Protection for persons against access to dangerous parts
0 (not protected)	(not protected)
4 diameter 1 mm	1 mm Ø wire
5 protected against dust	1 mm Ø wire
6 sealed against dust	1 mm Ø wire

2nd numeral	
Protection equipment provides against ingress of water	
0 (not protected)	
4 splashed water	
5 hosed water	
6 high-pressure hosed water	
7 temporary immersion	
8 prolonged immersion	

Under this classification, our switches come within the following categories :

- Plain switches = IP 00
- Protected switches = IP 40 with isolated connection
- Sealed switches = IP 66 or IP 67

Products and specifications subject to change without notice.

Order/Technical Support – Tel: (800) 677-5311 / FAX: (800) 677-3865 / www.crouzet-usa.com

Dielectric characteristics

Current rating

This is the current the switch is capable of making and breaking which forms the basis for the life tests.

Thermal rating

This is the current the switch will withstand when not being operated, for a temperature rise of not more than 60 °C.

Switch rating

AC voltages: see the current rating.
With DC voltages the switch rating is very much dependent on the voltage, the contact gap (CG) and the nature of the load being switched. There is a risk of prolonged or indeed permanent arcing if the following limits are exceeded:

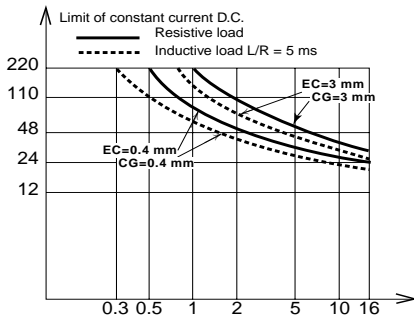

For special applications, please enquire.

Operating curves

These indicate the electrical life of the switches, under standard conditions (20 °C, 1 cycle/2 seconds), by showing the number of switching operations which can be performed with given types of load.

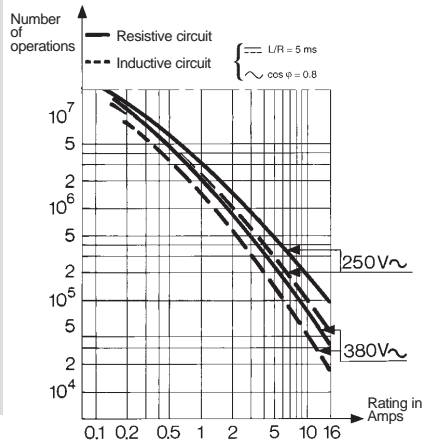

Products and specifications subject to change without notice.

Circuit types



Resistive circuit

For a circuit with alternating voltage, this is in phase with the current : $\cos \varphi = 1$.

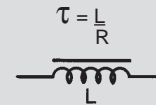

Inductive circuit

A circuit of this type with direct current is characterised by a time constant.
An inductive circuit, with alternating voltage, for example, incorporating a motor ($\cos \varphi < 1$) can cause current surges up to 6 times the normal current. For certain switches, we give electrical endurance curves with $\frac{L}{R} = 5$ ms in DC and $\cos \varphi = 0.8$ in AC.

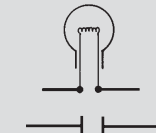
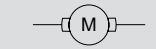

Lamp and capacitance circuit

The currents at the time when the circuit is closed are very high in this case, being up to 10 times the nominal figure.

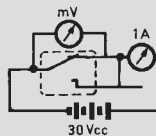

Internal resistance

This consists of the intrinsic resistance (fixed) of the parts carrying current and the contact resistance (variable).
Close to the tripping point and release position, the force holding the contacts together drops considerably and this may cause a rise in internal resistance.

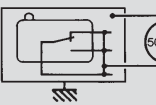

Insulation resistance

The insulation resistance of the switches is generally greater than 50,000 M measured at 500 V DC.

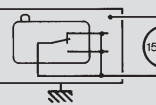

Dielectric strength

The dielectric strength of our switches is generally better than:

- 1500 volts between live parts and earth
- 1000 volts between contacts
- 600 volts between contacts for switches whose contact gap is less than 0.3 mm.

Contact materials

Choice of contact material

To choose the best material for the contacts there are various factors to be considered:

- the current and voltages levels
- the type of load
- the number of operations
- the switching frequency
- the environmental conditions.

Contacts for general-purpose use

Our switches are normally fitted with silver contacts. These are suitable for the majority of applications and provide the best compromise between electrical performance, thermal performance and life.

Contacts for low-power circuits

$E < 20 \text{ V}$ and/or $I < 100 \text{ mA}$

The contacts used in this case are plated with gold (or a gold alloy) for good reliability even in corrosive atmospheres.

Contacts for special applications

We can supply special contacts suitable for particular applications, such as:

- Ag CdO contacts for very high drawn currents,
- Cross Bar gold-plated Ag Ni contacts which allow a very wide range of applications to be covered by a single type of switch.

Electrical recommendations

Inductive circuits

To increase the life of contacts and their DC rating, arcing on opening can be cut down by using the following circuits:

- for DC

Fast diode $V_R > 5 \times V \text{ nominal}$
 $I \text{ nominal} > 10 \times I \text{ winding}$

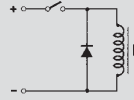

- for DC or AC

A - RC circuit across inductor
 B - RC circuit across switch

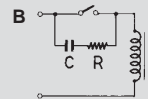
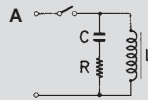

$C \text{ (nF)} \sim 100 \times I \text{ nominal (A)}$
 $V \text{ insulation} > V \text{ peak}$
 $R(\Omega) \sim \text{load resistance} (\Omega)$

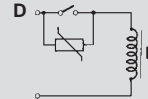
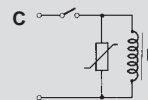

C - Varistor circuit across load
 D - Varistor circuit across switch
 $V > V \text{ peak supply}$

$$E \text{ (J)} = \frac{P \text{ (V.A.)}}{100}$$

Very low power circuits

In very low power circuits ($I > 1 \text{ mA}$, $V \leq 5 \text{ V}$), switching is highly sensitive to environmental conditions (the atmosphere, pollution).

If the supply is powerful enough, adding a passive resistor to increase the current broken by the switch to a few milliamps will substantially improve reliability of operation.

R - Load resistance
 C - Very low current load

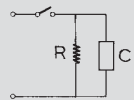

Methods of actuation

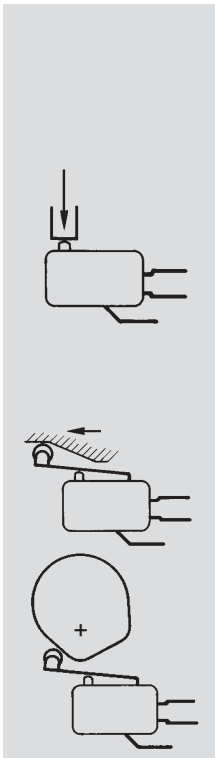

Direct operation

Preferably, force should be directly applied to the device – the plunger – along its axis for operation. However, the majority of our microswitches will accept skewed operation provided the angle of application is not more than 45°.

The device used to apply the force must never hamper the travel of the plunger to the tripping point (TP). It must under all circumstances move the plunger through at least 0.5 times the overtravel (OT) quoted. Steps must also be taken to see that it does not cause the overtravel limit (OL) or maximum overtravel force (MOF) quoted to be overrun or exceeded.

Operation by actuator

When operation is by a roller lever, force should preferably be applied in the direction shown on the left.

Where the movements involved are fast, the ramp should be so designed as to ensure that the operating device is not subjected to any violent impact or abrupt release.

Quality

Quality is built into our switches from the initial design stage right through to the point where they are put into action at the customer's premises. All departments of the company are guided by the Quality Manual and the stipulations of the ISO 9000 international standard.

The location where the switches are manufactured (the la Plaine works at Valence) holds **ISO 9001** certification, guaranteeing a high standard of quality.

Control procedures

Manufacturing quality of our switches is controlled systematically during assembly operations and on final completion. All our products are subjected to a final inspection, either at 100% on important characteristics, or according to the statistical sampling rules of French standards X 06-222 and X 06-023. The quality levels applied, for normal use such as defined in previous paragraphs are for the following defects, according to the standards :

- critical fault : NQA : 0.40
- major fault : NQA : 1
- minor fault : NQA : 2.5

At the customer's request, and for certain ranges of our products which must meet specific needs expressed in the specifications, it is always possible to adapt or create an inspection specification of a standard product.

Standards - Approvals

Our switches are designed according to international recommendations (IEC), American standards (UL) and/or European standards (EN).

Proof of compliance with these standards and recommendations is demonstrated by:

- the manufacturer's declaration of conformity (drafted in accordance with the ISO/IEC 22 guidelines), or
- approval granted directly by an accredited body, or by application of the CCA (Cenelec Certification Agreement).

More detailed information on the approval for a particular type of microswitch can be obtained on request.

The 83170 switch as an example

An 83 170 4 switch marked with the symbols for the European (according to CCA/MC12) and American approvals it holds.

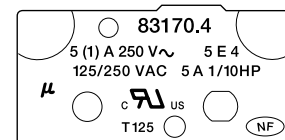

Rules and regulations

EC directives

Our switches are compatible with European Community technical directive (Low Voltage) 73/23 and can be used within the framework of Machinery directive 83/392.

Environmental protection

The modern concept of protection of the environment is an integral part of the manufacture of our switches, from product design through to packaging.

Products and specifications subject to change without notice.



Products and specifications subject to change without notice.

Order/Technical Support – Tel: (800) 677-5311 / FAX: (800) 677-3865 / www.crouzet-usa.com

Limit Switches – Technical Guide

Introduction

What is meant by a "position detector" is any device which needs to be operated by a member which exerts a physical force, in view of :

- either the form which its operating device takes
- or the considerable force needed to operate it

The distinguishing features of position detectors are :

- their high electrical performance capability
- their excellent resistance to accidental impact
- good protection against splashed or dripping water
- a wide range of operating devices to allow the detectors to be adapted to a vast variety of mechanisms

Construction

Our detectors are designed to conform to international IEC recommendations and/or European standards (EN). Proof that a detector conforms to these standards or recommendations takes the form of a conformity declaration made by the manufacturer (drafted as indicated in guidance document ISO/IEC 22 - EN 450-14). Characteristics in line with the general requirements of standards NFC 63140, IEC 947.5.1 and EN 60947.5.1.

- Leakage paths and air gaps : IEC 664.1 - NFC 20-040.

Our position detectors which comply with IEC 947.5.1 can be fitted to machine-tools and industrial machines complying with NFC 79130, IEC 204.1, EN60204 or VDE 113.

Electrical characteristics

Assigned working current (Ie):

- the current level adopted as a basis for the operating conditions quoted for a detector, and for the life tests on it.

Thermal rating (Ith):

- the current the microswitch will withstand when not being operated electrically, for a temperature rise of not more than 60 °C.

Assigned insulation voltage (Ui):

- the voltage adopted as a reference for the dielectric tests and leakage paths. It must be equal to or greater than the assigned working voltage.

Categories of use (IEC 947.5.1):

- AC 15 for operating AC solenoids and electromagnets
- DC 13 for operating DC solenoids and electromagnets

Contact element designation

(IEC 947.5.1):

- a letter and number which define the use category and the assigned working voltage and current
For example, A 300 means : in category AC 15, a maximum working voltage of 300 V and 6 A at 120 V or 3 A at 240 V.

Contact block electrical wiring diagram

Form Za



Both contacts have the same polarity

Form Zb



The 2 contacts are electrically isolated

Positive break contact operation (IEC 947-5-1, chapter 3) ☹

For contacts used in safety applications, limit switches, emergency stop devices, assurance that opening has occurred is essential (see IEC 204, EN60204). After each attempt, contact opening is checked by an impulse voltage test (2500 V).

Contact element :

- Snap action contact

This is characterized by tripping points and release points which cannot be confused. The speed at which the control devices moves is independent from the speed of the control device. This feature makes it possible to obtain satisfactory electrical performance even where the control device is moving at low speed.

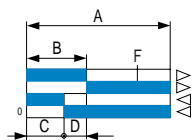

A : Total travel (TT) of the control device
B : Pre-travel (PT) until the contact element opens
C : Release travel until the contact element closes
D : B-C = Differential travel
F : Travel required to reach the positive opening point (POT)

Rules and regulations

EC Directives

Our detectors conform to the EC Low Voltage Technical Directive 73/23/EEC and can be used in accordance with the specifications of the Machinery Directive 89/392/EEC.

Environmental conditions

Temperature limits

When they are used in the temperature range quoted, the mechanical and electrical characteristics of our position detectors will remain substantially unchanged. If you intend to use them outside this range, please consult us.

Protective treatment

The treatment given to our position detectors is suitable in the vast majority of applications.

Parts made of steel are zinc-coated or painted according to their mechanical function. Further information is available on request. This treatment allows our detectors to be used under the following temperature and humidity conditions :

T °C	20	40	50
Relative humidity %	95	80	50

This treatment may thus be suitable for applications in tropical or equatorial climates where the equipment concerned is in an interior location sheltered from direct exposure to atmospheric conditions.

Other types of reinforced protection are possible for resistance to very severe environments.

Please enquire.

Mounting requirements

Electric shock protection.

The user should observe the mounting instructions relating to the mode of protection against electric shocks defined in the IEC 536.1, EN 60204.1 - NFC 20030 standards :

Class I : earth circuit link. Protection via differential circuit-breaker.

Class II : double insulation.

Class III : very low safety voltage.

Screw tightening torque :

1 : Actuator tightening	1.2 to 1.5 Nm	
	Plastic body	Metal body
2 : Head fixing screw	0.7 to 0.8 Nm	0.8 to 1 Nm
3 : Body fixing screw	0.7 to 0.8 Nm	0.8 to 1 Nm
4 : Fixing screw	2 to 2.5 Nm	

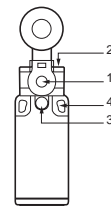

Adjustment of rotary heads with momentary action to right and left :

For series 83 850, 83 851, 83 861, 83 854, 83 855, 83 863

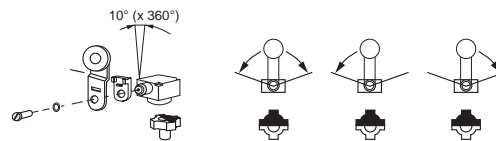

Degree of protection

Under the IEC 529 or NFC 20010 classification scheme, standards employ an IP code to define the degree or class of protection which a position detector provides against access to live components and against the entry of solid foreign bodies and the entry of water.

1 st numeral		
Protection equipment provides against the entry of solid foreign bodies		Protection for persons against access to dangerous parts
0	(not protected)	(not protected)
4	diameter 1 mm	1 mm Ø wire
5	protected against dust	1 mm Ø wire
6	sealed against dust	1 mm Ø wire

2 nd numeral		
Protection equipment provides against the entry of water		
0	(not protected)	6 high-pressure hosed water
4	splashed water	7 temporary immersion
5	hosed water	8 prolonged immersion

Products and specifications subject to change without notice.

Order/Technical Support – Tel: (800) 677-5311 / FAX: (800) 677-3865 / www.crouzet-usa.com

Mechanical characteristics

Terminology

Forces - Positions - Travel

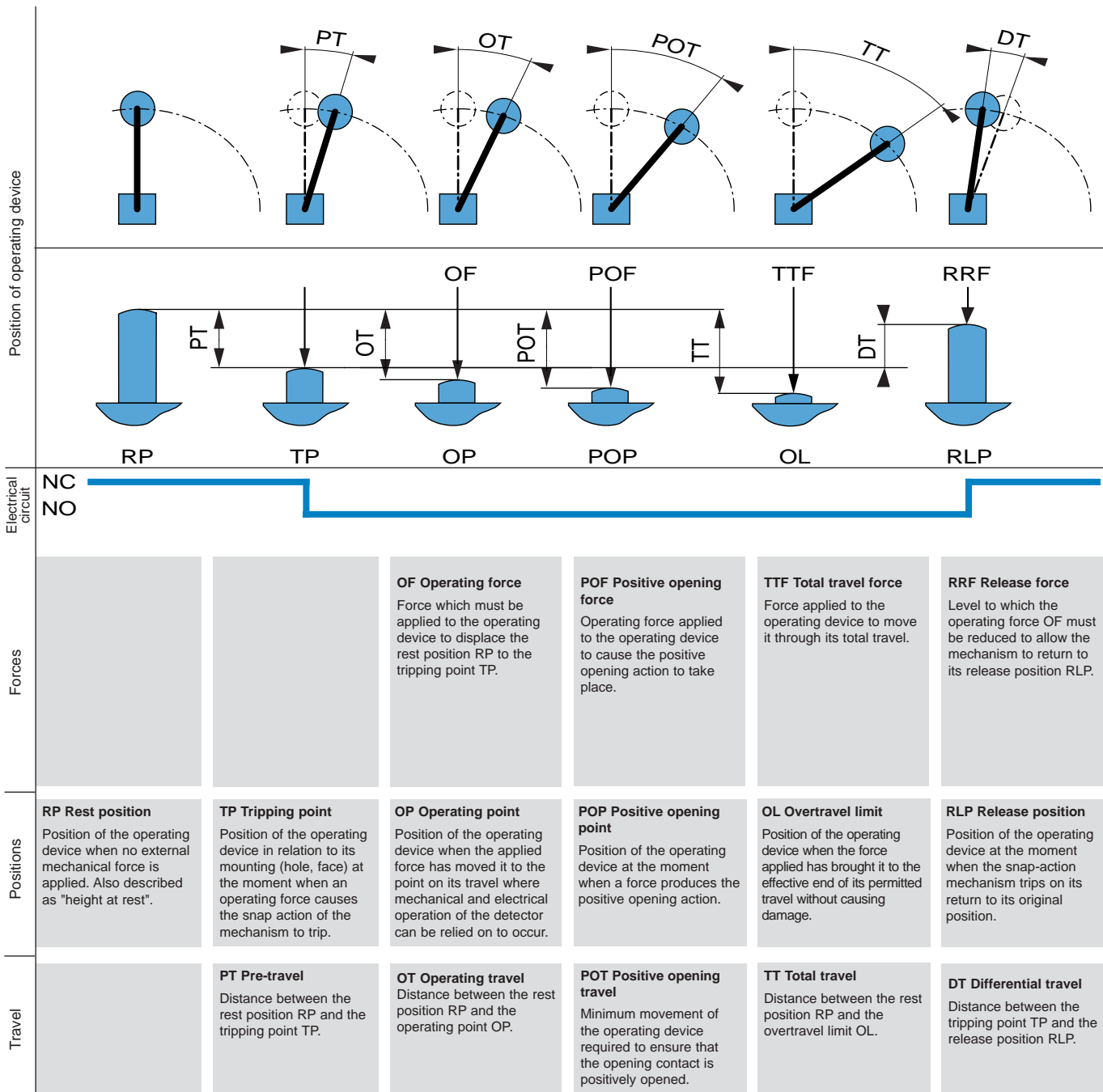

- Positive opening action : see IEC 947-5-1 chapter 3, § 2.2

N.B. : The max. and min. values quoted for each detector (min. operating force, max. total travel, etc.) are the maxima and minima users must allow for if they are to use our products under the proper conditions.

Products and specifications subject to change without notice.

Order/Technical Support – Tel: (800) 677-5311 / FAX: (800) 677-3865 / www.crouzet-usa.com

Key Operated Safety Limit Switches – Technical Guide

Standards

Extract from standards EN 292-2 and EN 1088.

Moving guards to prevent risks created by moving (and therefore dangerous) parts must be used in conjunction with locking devices or interlocks with guard locking.

Interlocks with guard locking must be used on machines with inertia.

An interlock with guard locking must be used if the stopping time is greater than the time required for a person to reach the danger zone. This mechanism will delay unlocking the moving guard until the dangerous movement has actually stopped.

Areas of application

Key-operated safety interlock switches have been designed specifically for protecting operators working on dangerous machines. They can be used to lock or unlock moving guards on industrial machines, and meet the requirements of standards EN 292-2, EN 294, EN 1088 and EN 60204-1.

Key-operated safety interlock switches are mainly used in applications which form part of the machine operating process. They are used to stop any dangerous movement whenever the moving guard system is open.

Examples of application

Monitoring of immediate access moving guards

- ① Level 3 for 1 or 2 moving cover(s): KNA3-XS + 83 893 001

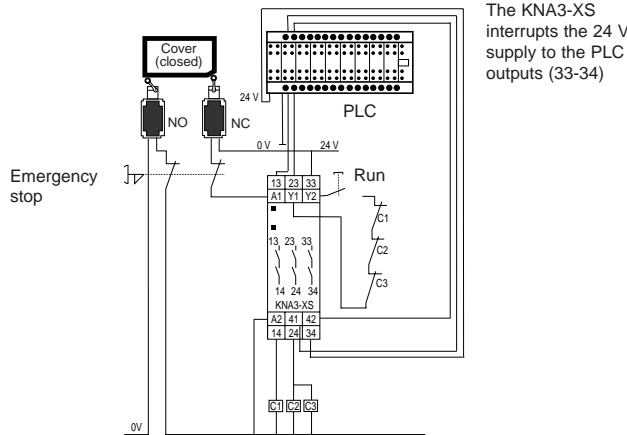

Emergency stop and moving cover controlled by two channels on terminals 41-42 (data contact) to a PLC output.

Monitoring of immediate access rotary guards

- Level 3 for 1 moving cover: KNA3-XS + 83 893 3

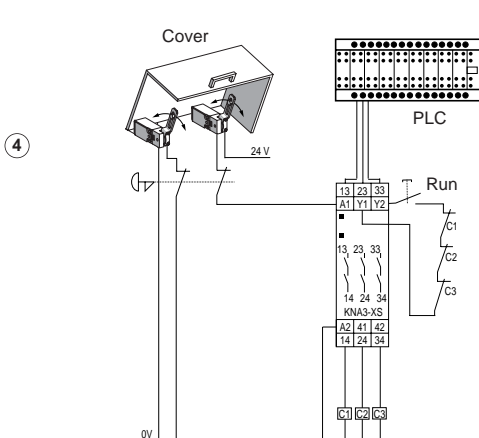

Machine control circuits

The use of safety interlock switches in conjunction with XS and RS safety relays creates control circuits conforming to EN 954-1.

Operating principle

The start circuit is only closed after the key has been inserted fully and is used to close the NC contacts. Removing the key once the moving cover is open causes the positive action opening of the NC contact(s).

The opening of the moving guard can be:

Immediate

Machines without inertia. Machines with a stopping time which is less than the time taken to access the danger zone.

Delayed

Machines with a stopping time which is greater than the time taken to access the danger zone.

Monitoring of delayed access moving guards

- ② Level 3 for 1 moving cover: KZR3-RS + 83 893 201
- ③ Level 4 for 1 moving cover: KNA3-RS + KSW2-RS + 83 893 201

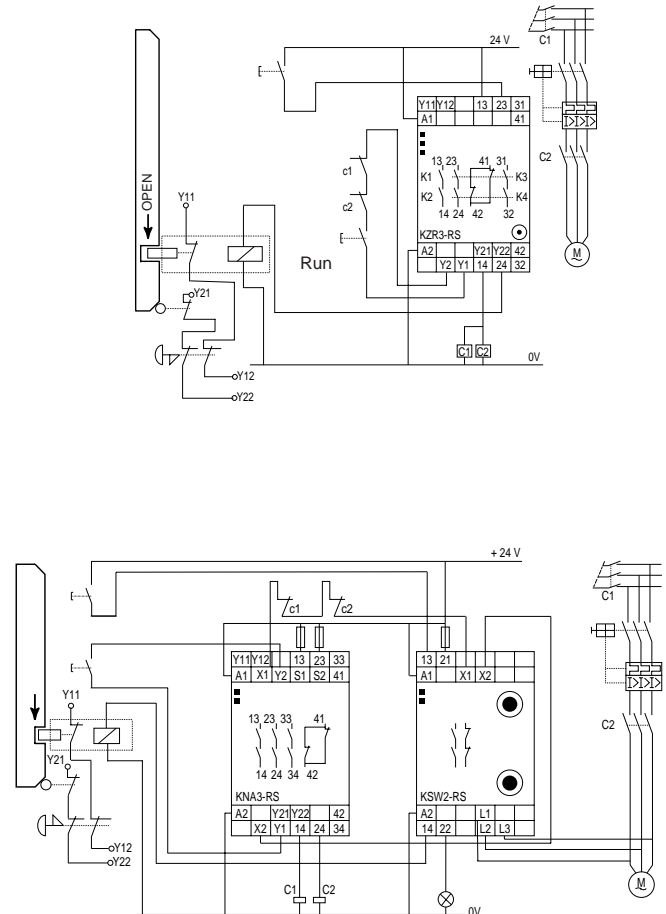

Products and specifications subject to change without notice.

Order/Technical Support – Tel: (800) 677-5311 / FAX: (800) 677-3865 / www.crouzet-usa.com



Key-operated safety interlock switch, plastic

Without key locking

Switches with plastic body for use on light machinery, **without inertia**. For use in unstable environments where there is a risk of the guard opening accidentally (due to vibrations, if the guard is positioned at an angle, bouncing of the guard, etc). **The guard is kept closed by adding a door stopping mechanism.**

With interlocking and locking of the key using an electromagnet

Devices in plastic cases for use on machines **with inertia**, or which require controlled opening of the guard. The moving guard is locked by removing the voltage, or by applying voltage to the electromagnet. A special tool can be used to unlock the guard manually, to ensure the safety of personnel carrying out maintenance operations on the machine, or if there is a malfunction.

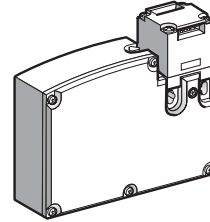
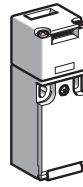

Key-operated safety interlock switch, metal

Without key locking

Switches with metal body for use on machines **without inertia** in a **stable environment** where there is no risk of the guard opening accidentally (due to vibrations, if the guard is positioned at an angle, bouncing of the guard, etc)

With interlocking and locking of the key using an electromagnet

Devices in metal cases for use on machines **without inertia**, or which require controlled opening of the guard. The moving guard is locked by removing the voltage. A key-operated lock can be used to unlock the guard manually, to ensure the safety of personnel carrying out maintenance operations on the machine, or if there is a malfunction. These devices are fitted with 2 LEDs: one indicates the opening/closing of the guard, the other whether it is locked.

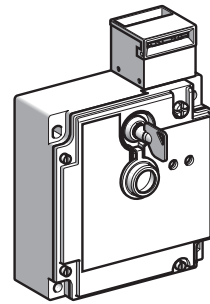
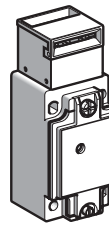

Safety switch for hinged guards

With angular or rotary movement head

Switches with plastic body and angled lever or rotary shaft. They are designed for use on small industrial machines with compact doors, covers or **rotating housings**. These ensure the safety of the operator by stopping the dangerous movement immediately the lever or rotary shaft reaches an angle of 5°. These devices provide a solution for monitoring **rotary guards** with a small opening radius on machines without inertia. They are particularly suitable for adapting existing machines to meet applicable standards, as they can be mounted on covers which are already installed, including those mounted imprecisely. Mounting the switch increases the safety of the operator as it reduces the opening distance of the guard, and therefore the risk of reaching the danger zone.

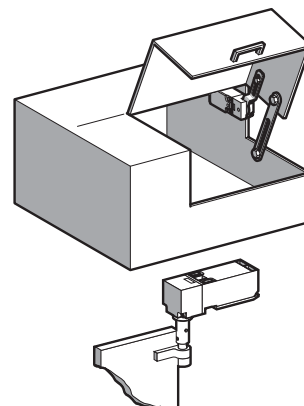
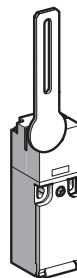

Products and specifications subject to change without notice.

Order/Technical Support – Tel: (800) 677-5311 / FAX: (800) 677-3865 / www.crouzet-usa.com

Operating principles

Figure 1 illustrates the principle of an Inductive Proximity Detector (I.P.D.)

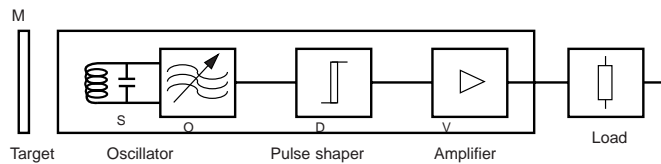

The I.P.D. signals the presence of a metal object "M" close to its sensing face.

It contains a high-frequency oscillator "O" whose oscillating circuit coil "S", located in a magnetic ferrite open on one side, forms the sensing face. An alternating magnetic field is created in front of this. On entering this field, any metal part "M" causes eddy currents, thus reducing the amplitude of oscillation. This reduced amplitude is converted by the pulse shaper "D" into an output signal amplified by "V".

Operating characteristics:

Sensing distance S: Distance at which the target determines a change in the status of the output signal, as it approaches the sensing face.

Nominal sensing distance S_n : Conventional value used to describe the device. Does not take account of dispersion (due to manufacturing, temperature, voltage).

Actual sensing distance S_r : Actual value measured from constant parameters (temperature, voltage, installation conditions etc), which must be between 90 and 110 % of the nominal sensing distance S_n .

$$0.9 S_n < S_r < 1.1 S_n$$

Usable sensing distance S_u : Value measured within the specified limits of the temperature and voltage zones, which must be between 81% and 121% of the nominal sensing distance S_n .

$$0.81 S_n < S_u < 1.21 S_n$$

Operating sensing distance S_a : Distance within which the detector will operate correctly in specified conditions.

$$0 < S_a < 0.81 S_n$$

Repeatability R: Value of variation in the actual sensing distance S_r in specified conditions (time, temperature, voltage).

Differential travel H: Distance between the pick-up point when the target approaches the detector and the drop-out point when the target moves away.

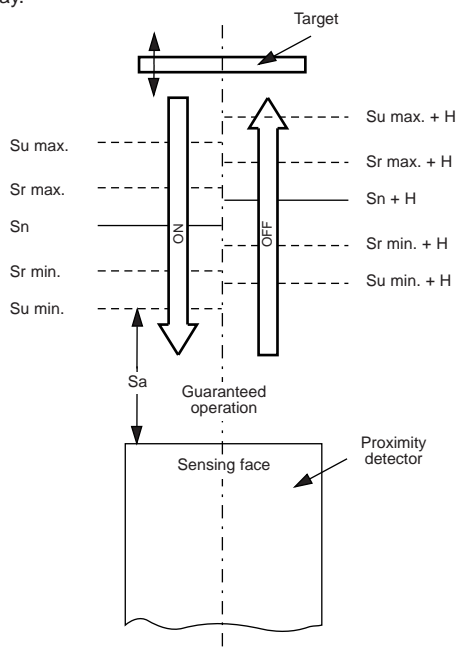

Method of measuring sensing distances: according to standard EN 50010.

Lateral approach and axial approach:

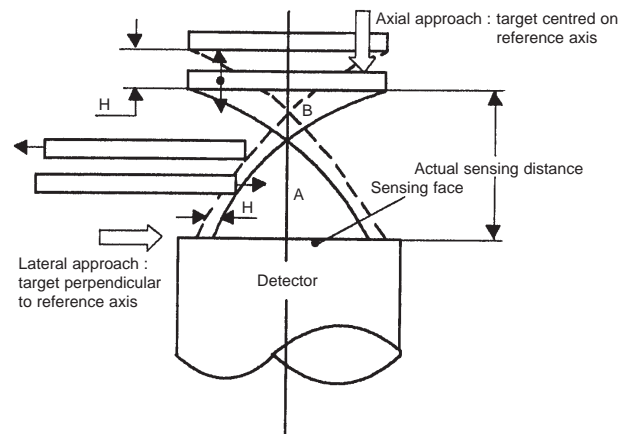

Electrical characteristics:

Normally open function (NO): Corresponds to a detector whose output allows the current to pass through when the target is detected.

Normally closed function (NC): Corresponds to a detector whose output blocks the current when the target is detected.

Equivalent circuit diagram

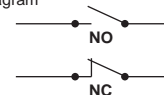

Voltage drop U_d : Voltage measured across the active output of the detector in closed state under its nominal operating current (load current I_a).

Load current I_a : Maximum current with which the detector permanently operates correctly.

Leakage current I_r : Current which continues to circulate in the load and in the output circuit when the detector is in the open state.

Minimum operating current I_m : Current necessary to maintain conduction of the switching element.

Time delay before availability T_v : Time necessary for the sensor output signal to operate when powering up.

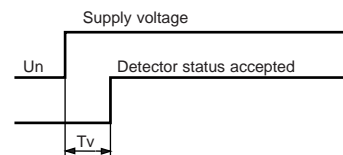

Switching frequency F: Number of operating cycles carried out during a specified time. It is measured according to the method shown below (Standard EN 50010 NFC 63075).

m : width of the target.

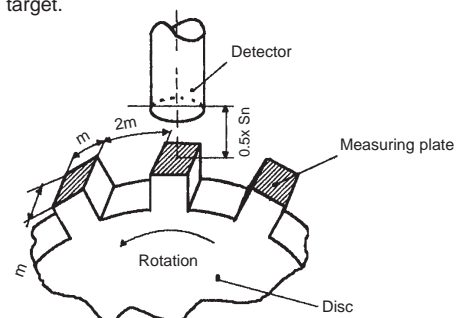

Operating voltage U_n : Voltage range within which the detector maintains its specified characteristics.

Ripple voltage: Ratio between the amplitude of an alternating voltage (peak to peak) and the direct voltage on which it is superimposed.

Products and specifications subject to change without notice.

Order/Technical Support – Tel: (800) 677-5311 / FAX: (800) 677-3865 / www.crouzet-usa.com

Detection characteristic curves - cylindrical CENELEC types

Screened versions

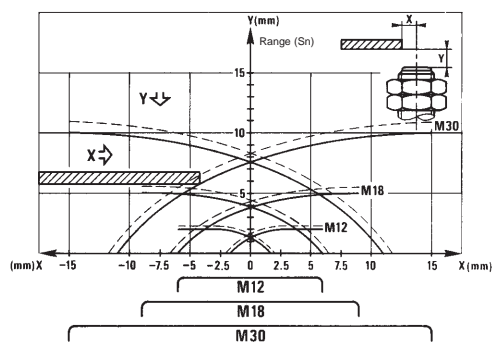
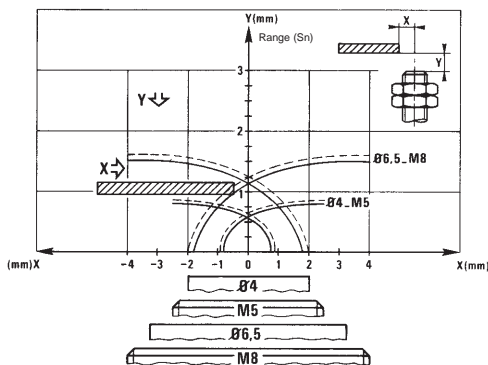

- Approach detection curve
- Withdrawal detection curve (side detection)
- Sn Nominal sensing distance

Non-screened versions

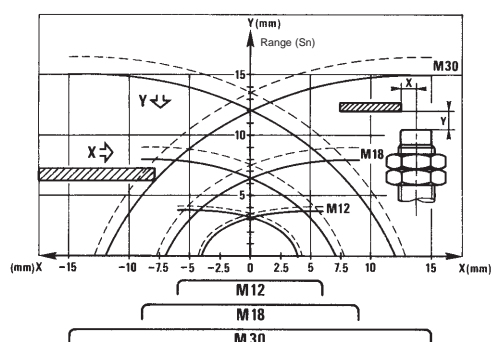
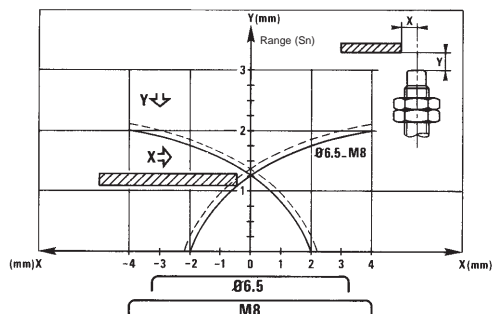

- Approach detection curve
- Withdrawal detection curve (side detection)
- Sn Nominal sensing distance

SCREENED IPD

Ø mm	Dimensions (mm) of sensed plate of A37 steel	Nominal sensing distance Sn (mm)
Ø4	5 x 5 x 1	0.....0.8
M5	5 x 5 x 1	0.....0.8
Ø6.5	8 x 8 x 1	0.....1.5
M8	8 x 8 x 1	0.....1.5
M8 ext	8 x 8 x 1	0.....3
M12	12 x 12 x 1	0.....2
M12 ext	12 x 12 x 1	0.....6
M18	18 x 18 x 1	0.....5
M18 ext	18 x 18 x 1	0.....12
M30	30 x 30 x 1	0.....10

NON-SCREENED IPD

Ø mm	Dimensions (mm) of sensed plate of A37 steel	Nominal sensing distance Sn (mm)
Ø6.5	8 x 8 x 1	0.....2.5
M8	8 x 8 x 1	0.....2.5
M12	12 x 12 x 1	0.....4
M18	18 x 18 x 1	0.....8
M30	30 x 30 x 1	0.....15

Notes

When materials other than steel are detected, the following correction factors must be applied :

Material	Correction factor
A37 mild steel	1
316 stainless steel	0.85
Brass	0.40
Aluminium	0.35
Copper	0.30

Products and specifications subject to change without notice.

Order/Technical Support – Tel: (800) 677-5311 / FAX: (800) 677-3865 / www.crouzet-usa.com

Electrical connection

3-wire DC

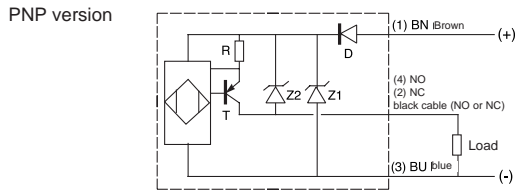

PNP output: load connected to negative supply

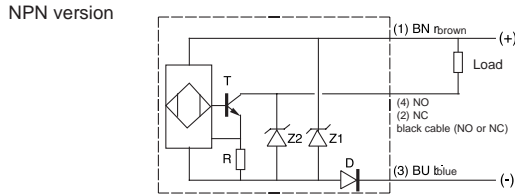

NPN output: load connected to positive supply

2-wire AC

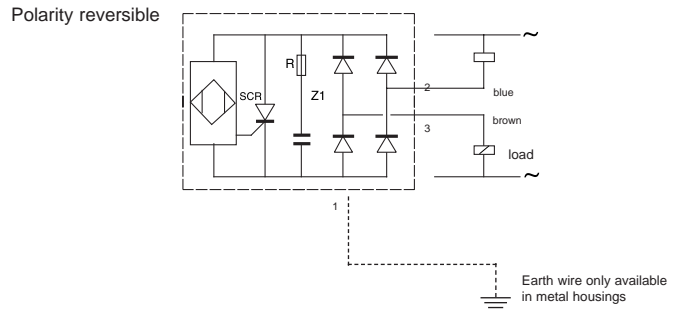

Installation

"**Screened**" sensors can be inset in surrounding metal rising flush with the sensing face. With "**non-screened**" versions, check that there is no metal in the immediate vicinity of the sensing face. European standards define the minimum distance which must be allowed between two sensors and/or between sensors and surrounding metal articles so that the sensors will not be affected.

The figures given below (which are in line with European standards) are for mounting in mild steel (A 37) with non-restrictive operating conditions. Where there are multiple constraints (deposits, temperature, etc) additional correcting factors will need to be applied.

Screened

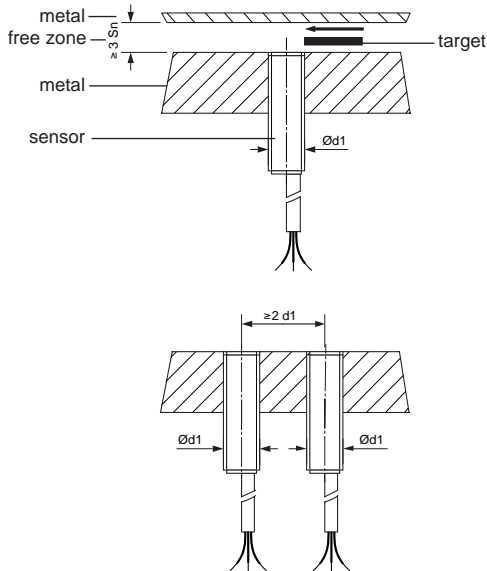

Non-screened

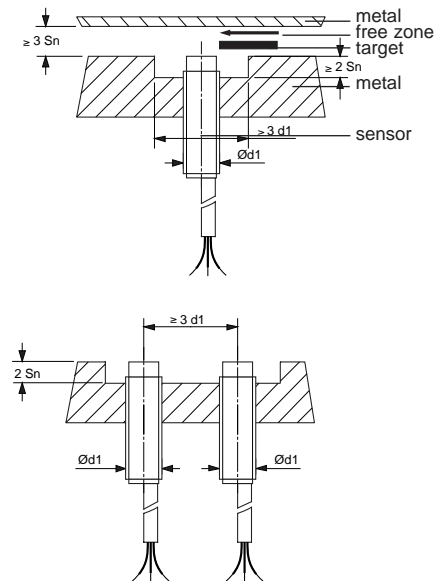

The sensing face of the sensor must not be positioned below the surface of the metal.

S_n : Nominal sensing distance
 $d1$: diameter of IPD

Where two sensors are installed facing one another, a gap of $10 \times S_n$ must be left between the two sensing faces.

Products and specifications subject to change without notice.

Order/Technical Support – Tel: (800) 677-5311 / FAX: (800) 677-3865 / www.crouzet-usa.com

Mechanical installation advice

Protection:

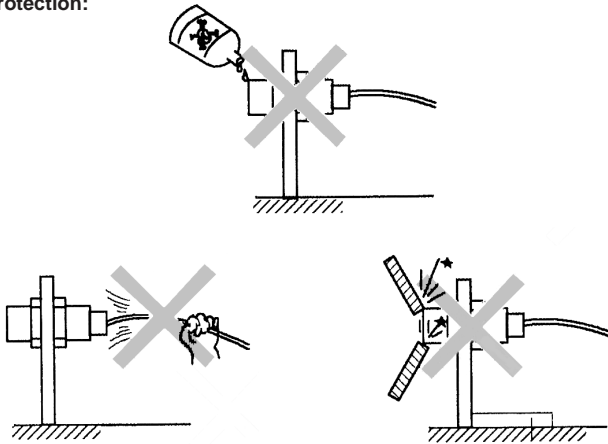

- Protect the cable against sharp objects or excessive heat.
- Do not exert a pulling force of more than 5 kg on the cable.
- The detectors are unable to withstand severe mechanical impact. The bracket must be sufficiently rigid to resist shock and vibration.
- Avoid using the detectors in a corrosive environment such as near strong acids, etc. (e.g. Nitric Acid).
- When a plastic detector is used in a chemical environment it is advisable to first verify the plastic's resistance to the chemical.

Electrical installation advice

Power supply:

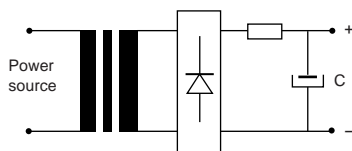

- Opposite is an example of a DC power supply for detectors using smoothing. To ensure that the resulting voltage is less than the maximum operating voltage of the detector, use a capacitor "C" to remove spikes and ripples greater than $\pm 10\%$. Ideally, use a transformer with a secondary voltage less than your required voltage.

Eg. 17.5 VAC from the secondary of the transformer to obtain less than 24 VDC.

Connection:

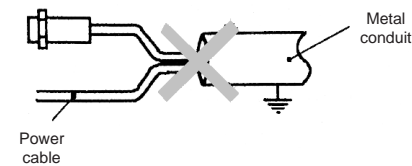

- Limit the length of the cables to 100 m and the capacitance of the line to 0.1 μF . Also separate detector cables and power cables as far as possible.

Connecting more than one sensor:

Series installation:

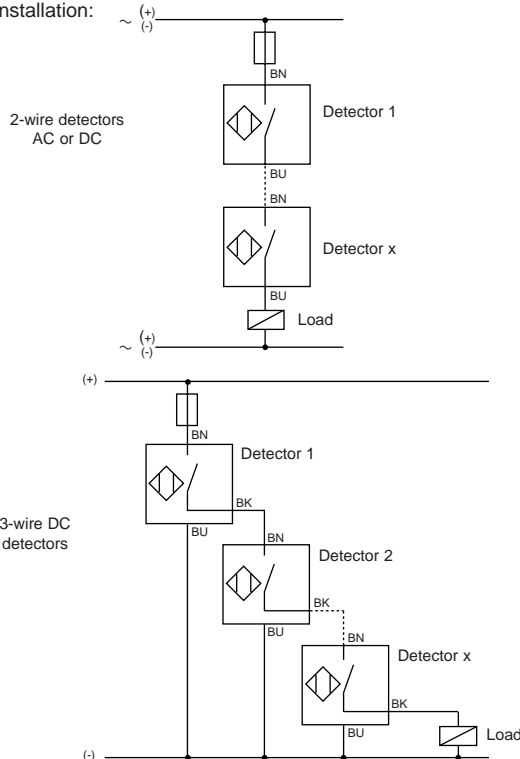

- It is possible to connect detectors in series:
 - Ensure that the voltage at the terminals of each sensor is less than or equal to the minimum operating voltage (in off-state).
 - In on-state, check that there is sufficient voltage available to activate the load.

This connection method is not possible if multivoltage sensors are used.

- With this connection method, add the voltage drop of each detector together and deduct from the supply voltage to ensure there is sufficient voltage to activate the load.

Note: detector 1 carries all the current for the additional detectors.

Products and specifications subject to change without notice.

Order/Technical Support – Tel: (800) 677-5311 / FAX: (800) 677-3865 / www.crouzet-usa.com

Inductive Proximity Detectors – Technical Guide

Parallel installation:

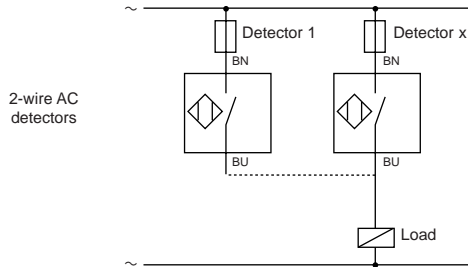

2-wire AC detectors

- With this type of installation the sum of the off-state leakage currents must be less than the current needed to drive the load.

Note: this installation should only be used with detectors which are activated one at a time.

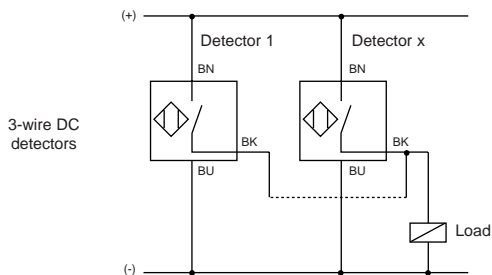

3-wire DC detectors

- It is possible to connect 3-wire detectors in this configuration without any problems.

Examples of applications

■ Part positioning

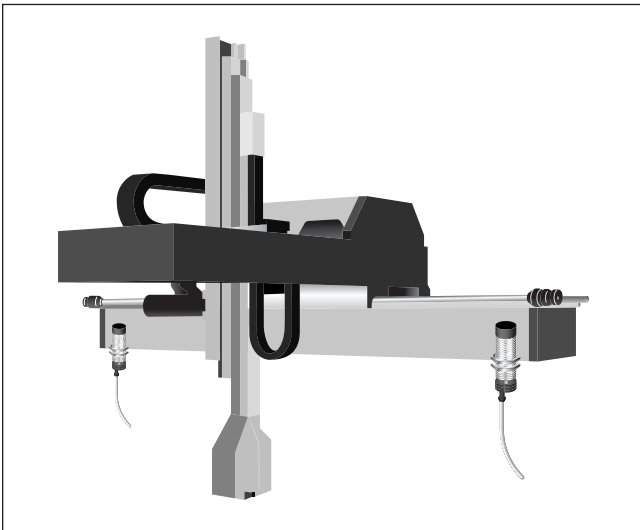

■ Parts recognition - Metal detection

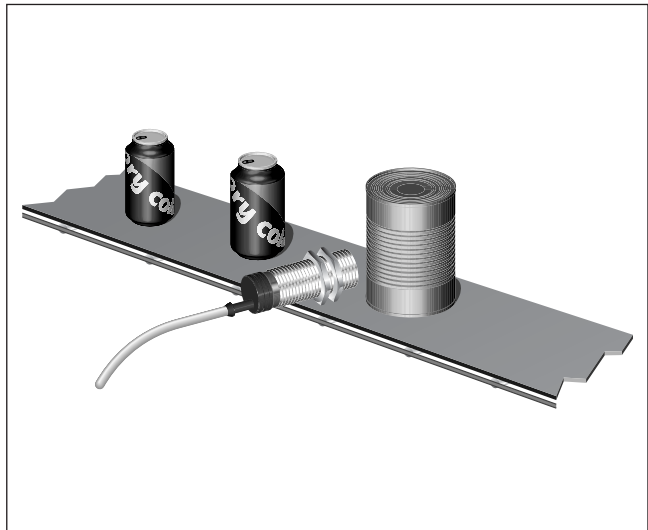

Products and specifications subject to change without notice.

Order/Technical Support – Tel: (800) 677-5311 / FAX: (800) 677-3865 / www.crouzet-usa.com

Examples of applications

■ Detection of broken drill

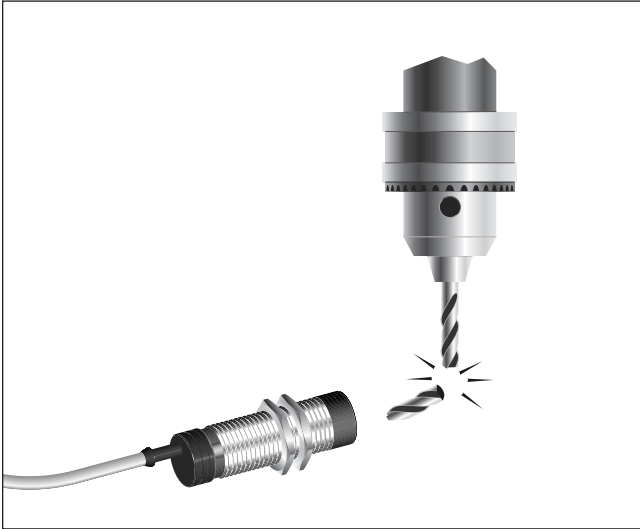

■ Control of robot grip

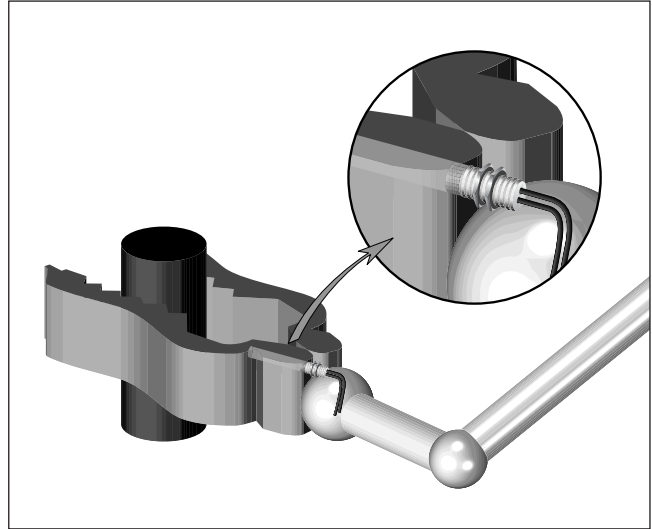

■ Rotation control

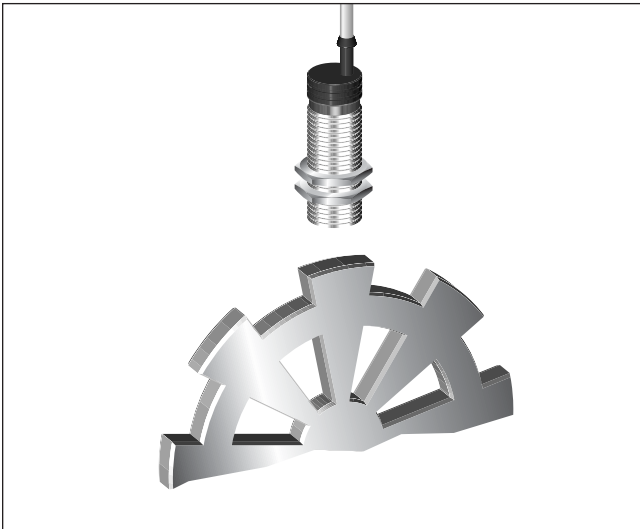

■ Screw detection

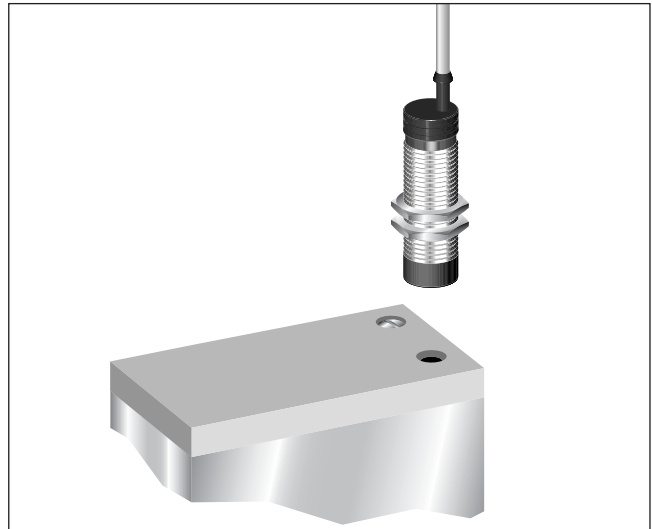

Products and specifications subject to change without notice.

Order/Technical Support – Tel: (800) 677-5311 / FAX: (800) 677-3865 / www.crouzet-usa.com

Capacitive Proximity Detectors – Technical Guide

Capacitive proximity detectors consist of an RC-oscillator with a special multi-part sensing electrode. The electrode and the oscillator circuit have a tube connected with earth potential for lateral screening. This enables flush-mounting of the sensor in metal, since the electrical field is only present in front of the sensing electrode. This field is the active zone of the sensor.

When the conductive material is removed from the active zone, the oscillator is undamped and the oscillation amplitude decreases. The oscillator voltage amplifier and the sensor sensitivity can be modified using the built-in potentiometer.

The middle electrode and built-in reclosing function provide excellent compensation in conditions of humidity, dust or freezing. A special circuit automatically compensates for these influences. The preset sensing range remains practically constant. The electrode and compensating circuitry of the capacitive sensors are unique in design, and provide operating performances far superior to other capacitive sensors.

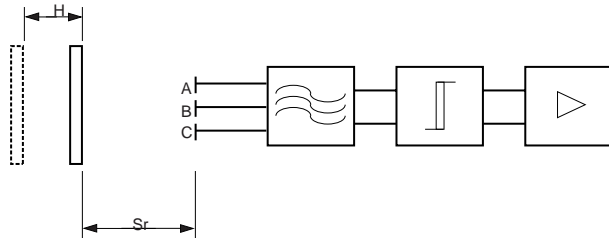

A indicates SENSOR ELECTRODE
B and C indicates COMPENSATION ELECTRODES

Applications

Capacitive sensors can be used to limit the level in tanks and containers. These may contain fluids, pulverised or granulated materials such as PVC, powder, dyes, flour, sugar, powdered milk, etc. These sensors can also be used as limit switches for checking and regulating machinery settings, even if the materials are not made of metal (as in conveyor belt positioning and material stacking), for checking drive belts and paper reels for sag and tear. Additionally, they can be used as detectors for counting metal and non-metal components.

Areas of application for capacitive sensors.

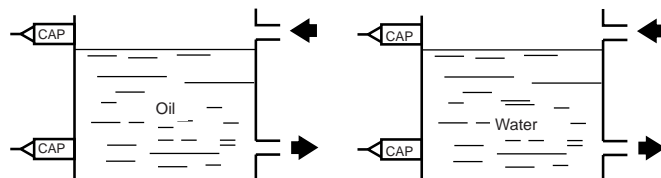
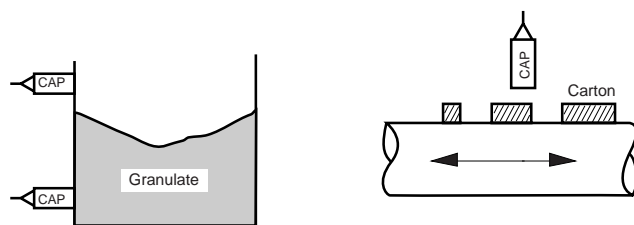

Screened configuration

Sensors with a straight line electrical field.

These units can sense solids (plates, components, PCBs, hybrids, cartons, bottles, plastic blocks and stacks of paper for example) at a distance or liquids through a separating wall (glass or plastic up to a maximum of 4 mm thick).



Non-screened configuration

Sensors with a spherical electrical field. These units are designed to touch the product, both bulk solids and liquids (granulate, sugar, flour, corn, sand or oil and water) with their active surface.

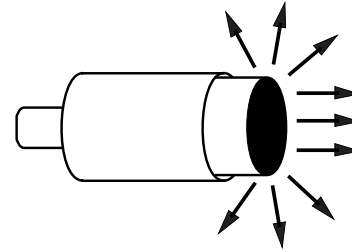

Sensing range

The data was obtained using a 1 mm thick square steel plate (steel 37) as an actuator, with a side length equal to 3 x Sn. The steel plate was grounded. The ambient temperature was 25°C. The maximum sensing range was defined as the nominal sensing range with a tolerance of ± 10%.

The sensing range depends on the shape, size and type of object concerned. If the plate is made of different material or has a smaller diameter, the sensing distance will be reduced.

Size correction factor

For objects which are not flat and which are smaller than the active sensor surface, the following sensing ranges are obtained depending on the scanned object F/FO surface, where F is the front sensor surface (active surface) and FO the front surface of the object being scanned. The figures in the table below refer to flush-mounting sensors and objects in the form of long thin rods.

Scanned object F/FO surface	Nominal sensing range Sn in mm
1.50	100
1.24	100
0.80	100
0.61	100
0.31	94
0.20	85
0.15	82.5
0.05	67.5
0.03	57.5

The diagram below shows the data from the table in graphic form.

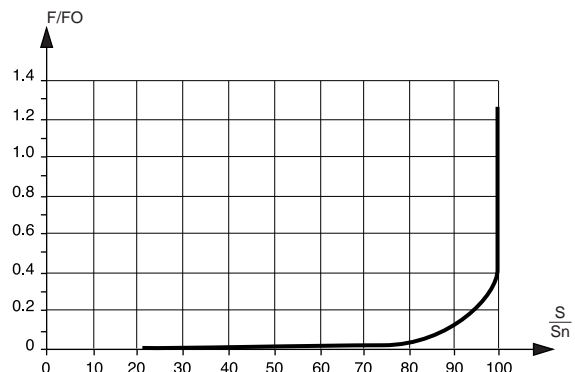

Products and specifications subject to change without notice.

Order/Technical Support – Tel: (800) 677-5311 / FAX: (800) 677-3865 / www.crouzet-usa.com

Capacitive Proximity Detectors – Technical Guide

Material correction factor

If the object in question is not metal or water, the sensing range is reduced. The reduction factors for the different materials are shown in the table below.

Material	Sensing range compared to a surface of water			
	20 mm	10 mm	15 mm	10 mm
Hand	20	10	15	10
Square steel plate (100 x 100 x 1)	20	10	15	10
Round steel plate (30 Ø x 1)	11	6	4	2
Stone (marble)	18	8.5	8	5
Wood	13	5	5	3
Glass	12	4	6	2.5
Carbon	19	9	12	9
PVC-block (30x30x5)	8	4	1.5	-
Lupolen granulate 1800 H	8	3	2.5	Head approx. 2 mm immersed
Polystyrene 454 H	9.5	3	4	1
Hostalen GC 8960 H	8.2	1.5	2	Head approx. 1 mm immersed
Vestyron 719-50	7.9	1.2	2	Head approx. 3 mm immersed
Hostyren	8.2	3	3	Head approx. 1 mm immersed
BM scrap material (Z)	6.7	1.4	1	Head surrounded
Hostalen GC coarse powder	8	2	1.5	Head approx. 3 mm immersed
Lupolen fine granulate	7.7	1.5	1	Head approx. 3 mm immersed
Hostaform C	9.8	3.5	4	1
Hostyren (polystyrene)	7.4	2	2.5	Head approx. 2 mm immersed
Hostalit S	7.5	2	1.5	Head surrounded
Hostalit PP	5	1.5	1.5	Head surrounded
Hostalit E	7.2	1	1	Head approx. 4 mm immersed
Styropor unfoamed	8.1	3	3	0.5
Styropor Ø 1.5	-	-	-	-
Antimony-trioxyde	6.2	0.9	2.5	Direct contact
Oil	9	3	5	3
Maximum sensing range critical point		55	110	
Conditions : Tu = 25 °C ; VA = 24 Vdc In each case, the measurements were made from a level surface.				

Sensitivity adjustment

Capacitive proximity detectors are fitted with a 14-turn potentiometer. The potentiometer must be adjusted to suit most applications. Turn in a clockwise direction to increase sensitivity. From the original setting of 0.7-0.8 x Sn (Sn = nominal sensing range), the nominal sensing range is reached after 2-3 turns. This leads to non-linearity of the curve and hypersensitivity, which may cause the sensor to lock. If this occurs, decrease sensitivity by turning the potentiometer 2-3 turns anticlockwise.

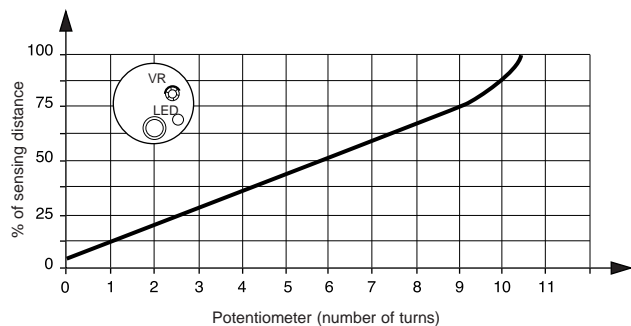

Temperature

Capacitive proximity detectors operate within a temperature range of -5°C to +70°C. The maximum sensing distance deviation is ± 10 % when the adjusted sensing distance at +20°C is no greater than the nominal specified distance (taking the material reduction factors into consideration).

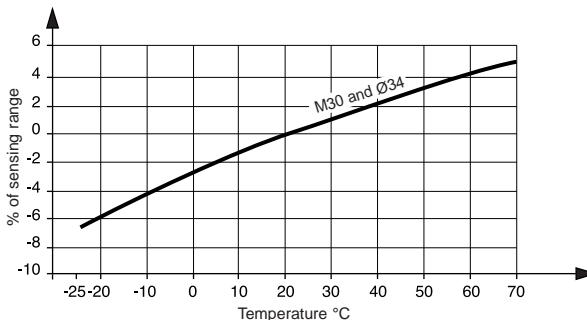

Example of setting procedure

A liquid (water, for example) is to be scanned through a separating wall by a sensor. The separating wall is made of glass or plastic, with a maximum thickness of 4 mm. The thickness in mm should be between 10 and 20% of the adjusted sensing distance, but always less than 4 mm.

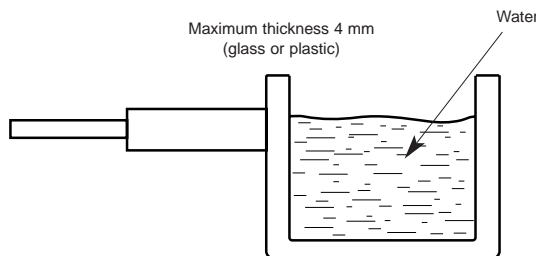

The face (active surface) of the sensor is bonded to the glass or plastic wall. The vessel is filled with water until approx. 75% of the active surface of the sensor is covered. Turn the sensor potentiometer anti-clockwise (to reduce the sensitivity) until the LEDs and the output signal turn off. Turn the potentiometer clockwise (to increase the sensitivity) until the LEDs and the output signal light up. Using the calibration process described ensures that the sensor does not detect the wall or the water residue on the wall. It only operates once the liquid has reached the 75% level described above.

Products and specifications subject to change without notice.

Order/Technical Support – Tel: (800) 677-5311 / FAX: (800) 677-3865 / www.crouzet-usa.com

Capacitive Proximity Detectors – Technical Guide

Installation conditions

The presence of surrounding objects may affect capacitive proximity detectors. These objects may reduce sensing capacity or may themselves be detected. It is necessary to maintain a standard distance between a capacitive proximity detector and the surrounding objects when installing this type of detector.

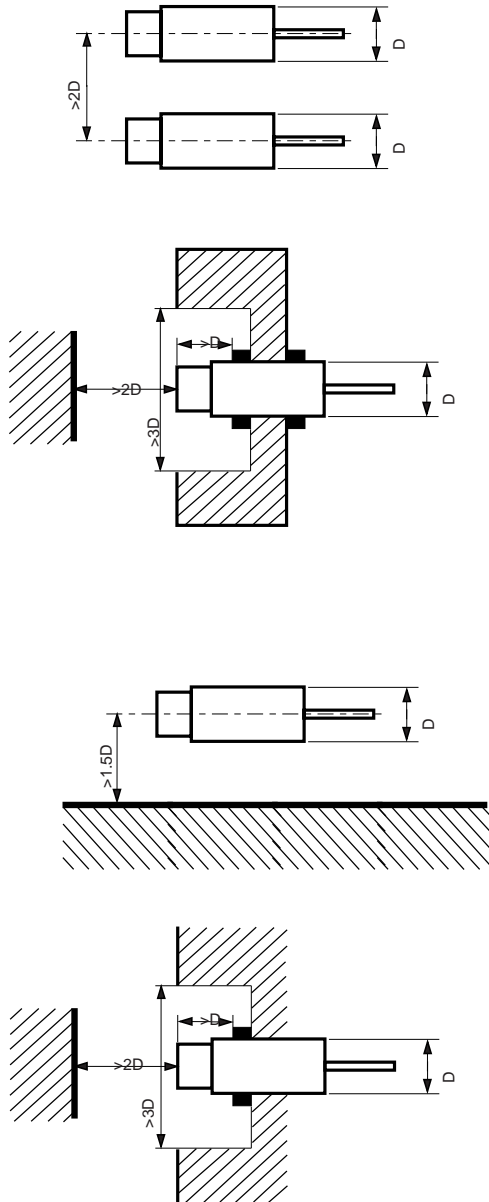

Effects of water droplets on the sensing face

The curves below illustrate the modifications to the operating range which may be caused by the presence of water droplets on the sensing face of a capacitive proximity detector. If the quantity of water droplets is 0.2 ml (approx. 2-3 drops), the operating range is extended by around 20 %; if the water droplets cover the entire sensing face, the operating range is extended by more than 300 %.

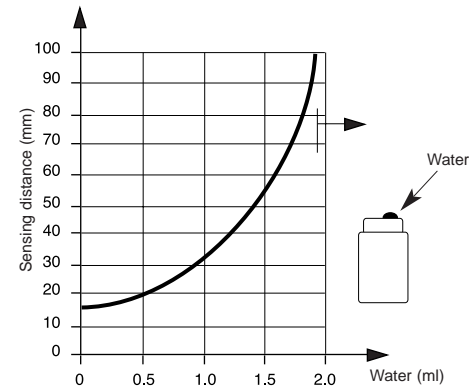
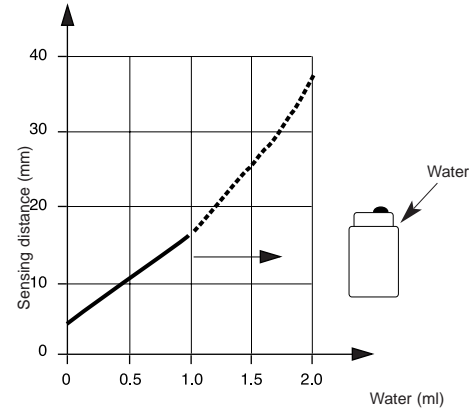

Warning

The presence of frost, ice, moisture, oil or dust on the active surface will prevent reliable operation.

The detection of liquids or powders attached to the walls of non-metallic vessels will prevent reliable operation.

Connecting a DC capacitive proximity detector to a high-load current (current higher than 200 mA) (for electric motors and electromagnetic contacts) will cause the output transistor to malfunction. The detector must be connected via a relay.

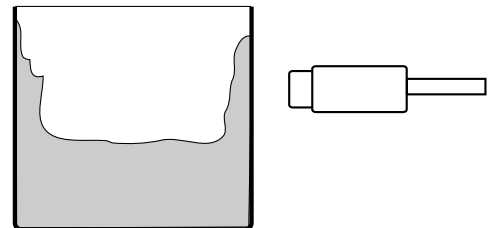

Products and specifications subject to change without notice.

Order/Technical Support – Tel: (800) 677-5311 / FAX: (800) 677-3865 / www.crouzet-usa.com



Products and specifications subject to change without notice.

Order/Technical Support – Tel: (800) 677-5311 / FAX: (800) 677-3865 / www.crouzet-usa.com



Products and specifications subject to change without notice.

Order/Technical Support – Tel: (800) 677-5311 / FAX: (800) 677-3865 / www.crouzet-usa.com



Products and specifications subject to change without notice.

Order/Technical Support – Tel: (800) 677-5311 / FAX: (800) 677-3865 / www.crouzet-usa.com



Products and specifications subject to change without notice.

Order/Technical Support – Tel: (800) 677-5311 / FAX: (800) 677-3865 / www.crouzet-usa.com



Products and specifications subject to change without notice.

Order/Technical Support – Tel: (800) 677-5311 / FAX: (800) 677-3865 / www.crouzet-usa.com

Mouser Electronics

Authorized Distributor

Click to View Pricing, Inventory, Delivery & Lifecycle Information:

Crouzet:

[83806051](#) [70602118](#) [70507526](#) [831613C6.EB](#) [IMB1805T](#) [83123018](#) [83123015](#) [83803051](#) [831613C3.L](#)
[831615C6.CBMR](#) [831613C6.CBMR](#)