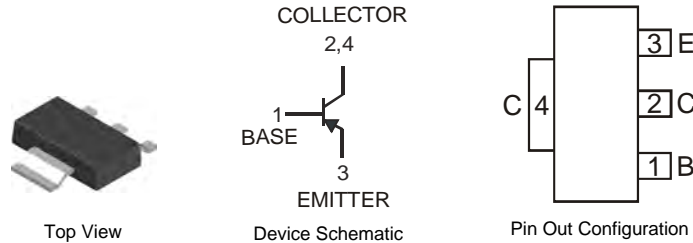


Features

- Ideally Suited for Automated Assembly Processes
- Complementary NPN Type Available (DJT4031N)
- Low Collector-Emitter Saturation Voltage
- Ideal for Medium Power Switching or Amplification Applications
- **Lead Free By Design/RoHS Compliant (Note 1)**
- **"Green" Device (Note 2)**

Mechanical Data

- Case: SOT-223
- Case Material: Molded Plastic, "Green" Molding Compound. UL Flammability Classification Rating 94V-0
- Moisture Sensitivity: Level 1 per J-STD-020D
- Terminals: Finish — Matte Tin annealed over Copper leadframe (Lead Free Plating). Solderable per MIL-STD-202, Method 208
- Marking Information: See Page 4
- Ordering Information: See Page 4
- Weight: 0.115 grams (approximate)



Maximum Ratings @ $T_A = 25^\circ\text{C}$ unless otherwise specified

Characteristic	Symbol	Value	Unit
Collector-Base Voltage	V_{CBO}	-40	V
Collector-Emitter Voltage	V_{CEO}	-40	V
Emitter-Base Voltage	V_{EBO}	-6	V
Peak Pulse Current	I_{CM}	-5	A
Continuous Collector Current	I_C	-3	A
Base Current	I_B	-1	A

Thermal Characteristics

Characteristic	Symbol	Value	Unit
Power Dissipation (Note 3) @ $T_A = 25^\circ\text{C}$	P_D	1.2	W
Thermal Resistance, Junction to Ambient Air (Note 3) @ $T_A = 25^\circ\text{C}$	$R_{\theta JA}$	104	$^\circ\text{C/W}$
Power Dissipation (Note 4) @ $T_A = 25^\circ\text{C}$	P_D	2	W
Thermal Resistance, Junction to Ambient Air (Note 4) @ $T_A = 25^\circ\text{C}$	$R_{\theta JA}$	62.5	$^\circ\text{C/W}$
Operating and Storage Temperature Range	T_J, T_{STG}	-55 to +150	$^\circ\text{C}$

- Notes:
1. No purposefully added lead.
 2. Diodes Inc.'s "Green" policy can be found on our website at http://www.diodes.com/products/lead_free/index.php.
 3. Device mounted on FR-4 PCB with minimum recommended pad layout.
 4. Device mounted on FR-4 PCB with 1 inch² copper pad layout.

Electrical Characteristics @ $T_A = 25^\circ\text{C}$ unless otherwise specified

Characteristic	Symbol	Min	Typ	Max	Unit	Test Conditions
OFF CHARACTERISTICS (Note 5)						
Collector-Base Breakdown Voltage	$V_{(BR)CBO}$	-40	—	—	V	$I_C = -100\mu\text{A}$
Collector-Emitter Breakdown Voltage	$V_{(BR)CEO}$	-40	—	—	V	$I_C = -10\text{mA}$
Emitter-Base Breakdown Voltage	$V_{(BR)EBO}$	-6	—	—	V	$I_E = -50\mu\text{A}$
Collector-Base Cutoff Current	I_{CBO}	—	—	-100	nA	$V_{CB} = -40\text{V}, I_E = 0$
		—	—	-50	μA	$V_{CB} = -40\text{V}, I_E = 0, T_A = 150^\circ\text{C}$
Emitter-Base Cutoff Current	I_{EBO}	—	—	-100	nA	$V_{EB} = -6\text{V}, I_C = 0$
ON CHARACTERISTICS (Note 5)						
DC Current Gain	h_{FE}	220	—	—	—	$V_{CE} = -1\text{V}, I_C = -0.5\text{A}$
		200	—	400		$V_{CE} = -1\text{V}, I_C = -1\text{A}$
		100	—	—		$V_{CE} = -1\text{V}, I_C = -3\text{A}$
Collector-Emitter Saturation Voltage	$V_{CE(SAT)}$	—	—	-150	mV	$I_C = -0.5\text{A}, I_B = -5\text{mA}$
		—	—	-200		$I_C = -1\text{A}, I_B = -10\text{mA}$
		—	—	-500		$I_C = -3\text{A}, I_B = -0.3\text{A}$
Equivalent On-Resistance	$R_{CE(SAT)}$	—	—	167	$\text{m}\Omega$	$I_E = -3\text{A}, I_B = -0.3\text{A}$
Base-Emitter Saturation Voltage	$V_{BE(SAT)}$	—	—	-1.0	V	$I_C = -1\text{A}, I_B = -0.1\text{A}$
Base-Emitter Turn-on Voltage	$V_{BE(ON)}$	—	—	-1.0	V	$V_{CE} = -2\text{V}, I_C = -1\text{A}$
SMALL SIGNAL CHARACTERISTICS						
Transition Frequency	f_T	—	150	—	MHz	$V_{CE} = -10\text{V}, I_C = -100\text{mA}, f = 100\text{MHz}$
Output Capacitance	C_{obo}	—	35	—	pF	$V_{CB} = -10\text{V}, f = 1\text{MHz}$
Input Capacitance	C_{ibo}	—	150	—	pF	$V_{CB} = -5\text{V}, f = 1\text{MHz}$
SWITCHING CHARACTERISTICS						
Turn-On Time	t_{on}	—	53	—	ns	$V_{CC} = -10\text{V}, I_C = -2\text{A}, I_{B1} = -200\text{mA}$
Delay Time	t_d	—	12	—	ns	
Rise Time	t_r	—	41	—	ns	
Turn-Off Time	t_{off}	—	180	—	ns	$V_{CC} = -10\text{V}, I_C = -2\text{A}, I_{B1} = I_{B2} = -200\text{mA}$
Storage Time	t_s	—	146	—	ns	
Fall Time	t_f	—	34	—	ns	

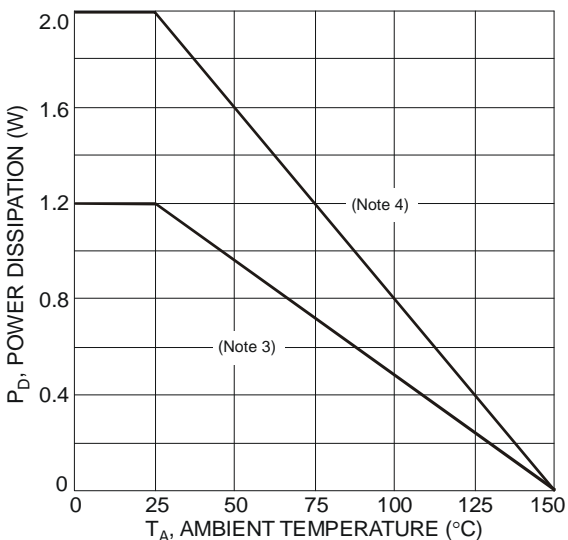
 Notes: 5. Measured under pulsed conditions. Pulse width = 300 μs . Duty cycle $\leq 2\%$.


Fig. 1 Power Dissipation vs. Ambient Temperature

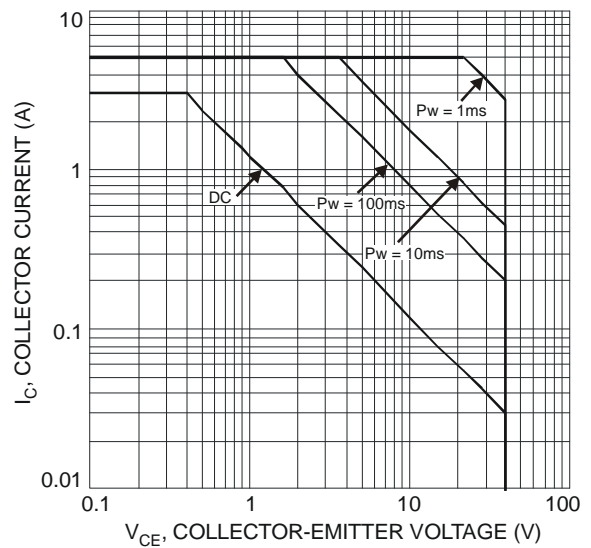


Fig. 2 Typical Collector Current vs. Collector-Emitter Voltage (Note 3)

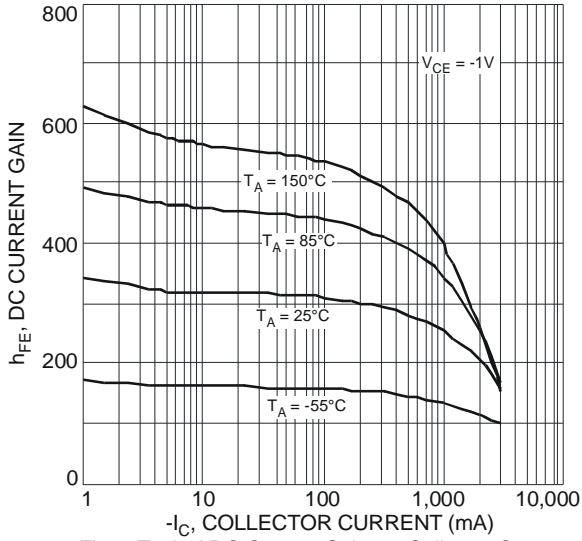


Fig. 3 Typical DC Current Gain vs. Collector Current

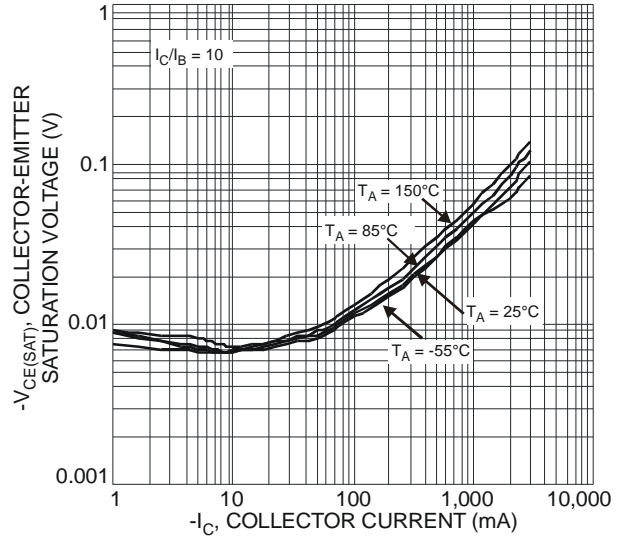


Fig. 4 Typical Collector-Emitter Saturation Voltage vs. Collector Current

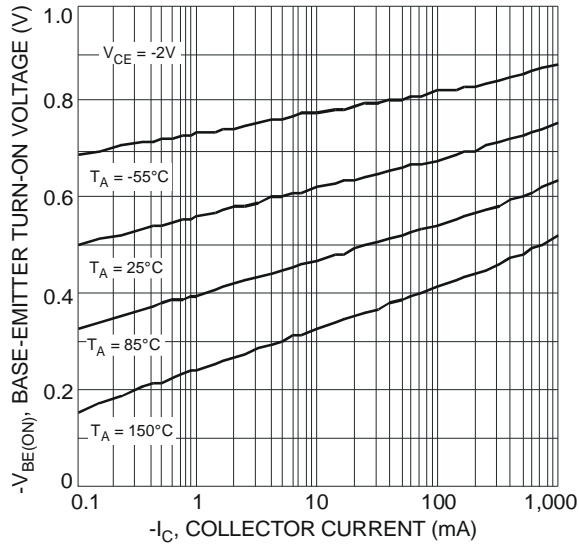


Fig. 5 Typical Base-Emitter Turn-On Voltage vs. Collector Current

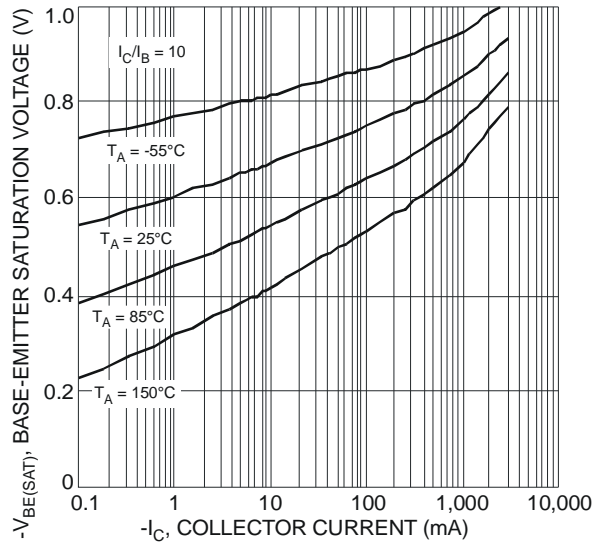


Fig. 6 Typical Base-Emitter Saturation Voltage vs. Collector Current

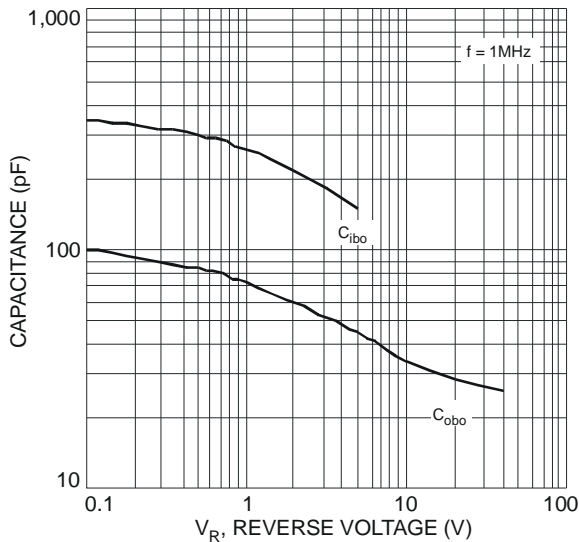


Fig. 7 Typical Capacitance Characteristics

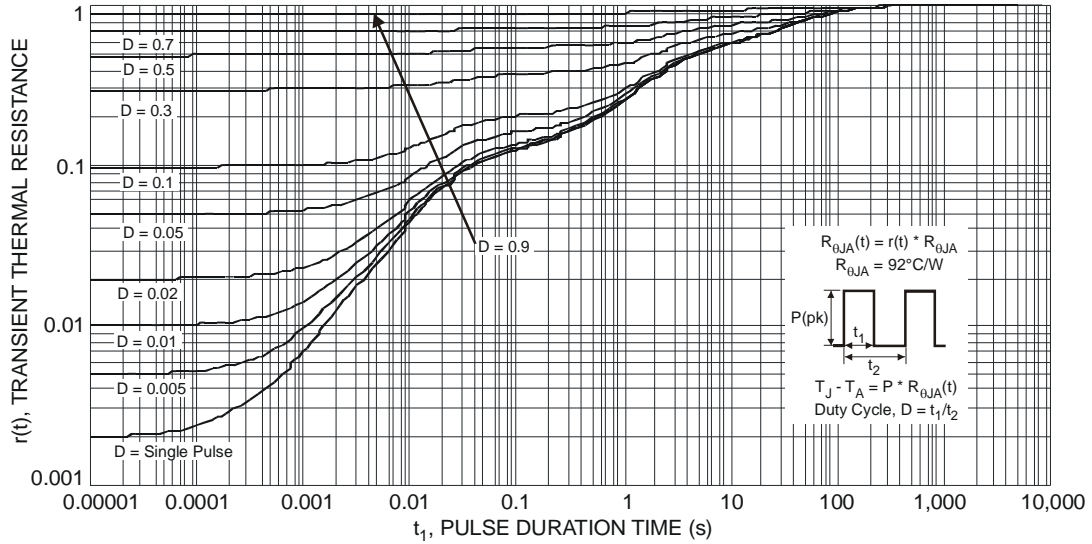


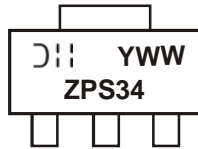
Fig. 8 Transient Thermal Response (Note 3)

Ordering Information (Note 6)

Part Number	Case	Packaging
DJT4030P-13	SOT-223	2500/Tape & Reel

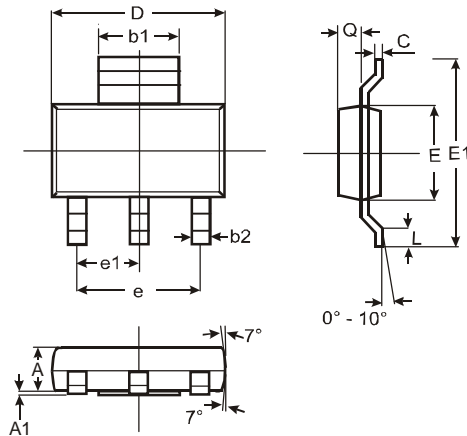
Notes: 6. For packaging details, go to our website at <http://www.diodes.com/datasheets/ap02007.pdf>.

Marking Information



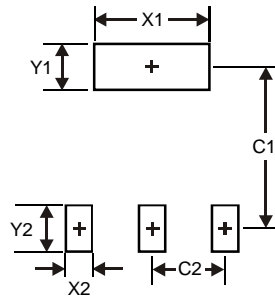
ZPS34 = Product Type Marking Code
 YWW = Date Code Marking
 Y = Last digit of year (ex: 8 = 2008)
 WW = Week code 01 - 52

Package Outline Dimensions



SOT-223			
Dim	Min	Max	Typ
A	1.55	1.65	1.60
A1	0.010	0.15	0.05
b1	2.90	3.10	3.00
b2	0.60	0.80	0.70
C	0.20	0.30	0.25
D	6.45	6.55	6.50
E	3.45	3.55	3.50
E1	6.90	7.10	7.00
e	—	—	4.60
e1	—	—	2.30
L	0.85	1.05	0.95
Q	0.84	0.94	0.89
All Dimensions in mm			

Suggested Pad Layout



Dimensions	Value (in mm)
X1	3.3
X2	1.2
Y1	1.6
Y2	1.6
C1	6.4
C2	2.3

IMPORTANT NOTICE

Diodes Incorporated and its subsidiaries reserve the right to make modifications, enhancements, improvements, corrections or other changes without further notice to any product herein. Diodes Incorporated does not assume any liability arising out of the application or use of any product described herein; neither does it convey any license under its patent rights, nor the rights of others. The user of products in such applications shall assume all risks of such use and will agree to hold Diodes Incorporated and all the companies whose products are represented on our website, harmless against all damages.

LIFE SUPPORT

Diodes Incorporated products are not authorized for use as critical components in life support devices or systems without the expressed written approval of the President of Diodes Incorporated.

Mouser Electronics

Authorized Distributor

Click to View Pricing, Inventory, Delivery & Lifecycle Information:

[Diodes Incorporated:](#)

[DJT4030P-13](#)