

MAX9947

AISG Integrated Transceiver

General Description

The MAX9947 is an AISG-compliant, fully integrated transceiver.

The MAX9947 receiver offers a typical dynamic range of 20dB and integrates a bandpass filter that operates in the 2.176MHz frequency with a narrow 200kHz bandwidth.

The MAX9947 transmitter integrates a bandpass filter that is compliant with the AISG spectrum emission profile. It can modulate OOK signals up to 115.2kbps. The output power can be varied with external resistors from +7dBm to +12dBm to compensate for loss in the external circuitry and cabling.

The MAX9947 also features a direction output to facilitate the RS-485 bus arbitration in tower-mounted equipment.

The MAX9947 is available in a small, 3mm x 3mm 16-pin TQFN and is rated for operation in the -40°C to +105°C temperature range.

Applications

- Base Stations
- Tower Equipment

Benefits and Features

- Receiver Wide Input Dynamic Range
 - -15dBm to +5dBm in 50Ω
- Variable Transmitter Output Level from +7dBm to +12dBm
- AISG-Compliant Output Emission Profile
- AutoDirection Output
- No Need of Microcontrollers to Handle Bus Arbitration in Tower-Mounted Equipment
- Supports All AISG Data Rates
 - 9.6kbps
 - 38.4kbps
 - 115.2kbps
- Bandpass Filter Compliant with AISG Protocol Centered Around 2.176MHz
- 3.0V to 5.5V Voltage Supply
- Independent Logic Supply
- Small, 3mm x 3mm 16-Pin TQFN Package

Ordering Information

PART	TEMP RANGE	PIN-PACKAGE	TOP MARK
MAX9947ETE+	-40°C to +105°C	16 TQFN-EP*	AHF

+Denotes a lead(Pb)-free/RoHS-compliant package.

*EP = Exposed pad. Connect EP to GND to enhance thermal dissipation.

Functional Diagram

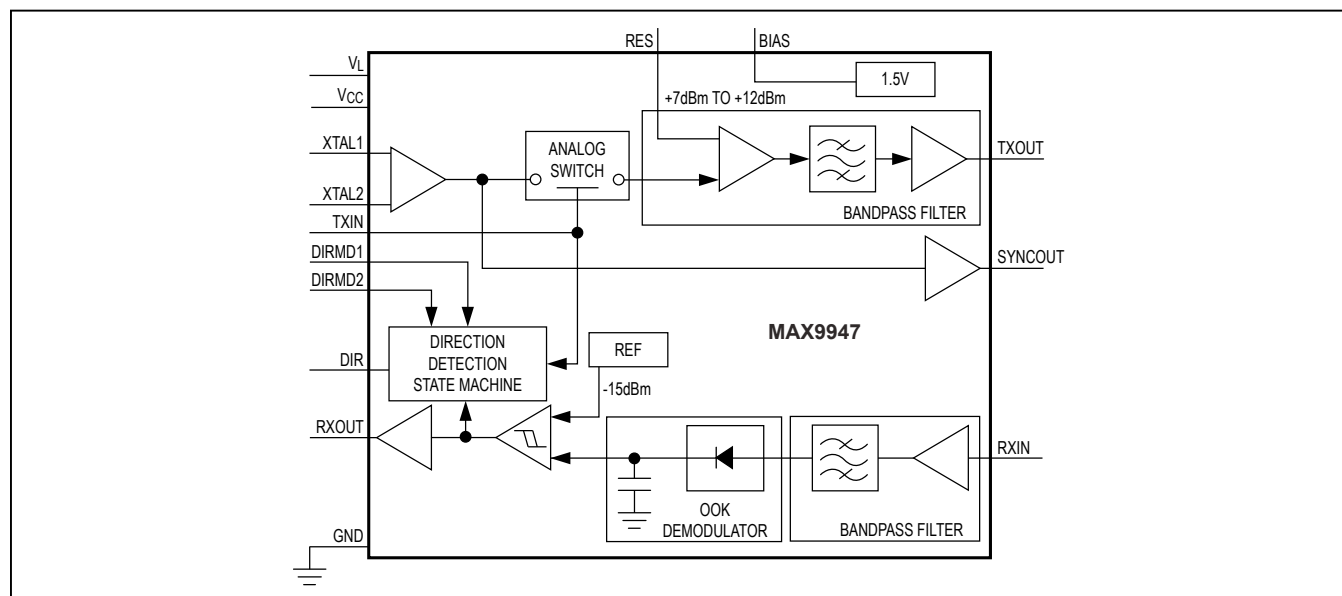

Absolute Maximum Ratings

V _{CC} to GND	-0.3V to +6V	All Other Pins Max In/Out Current.....	±20mA
V _L to GND	-0.3V to +6V	Continuous Power Dissipation (T _A = +70°C)	
TXOUT, BIAS to GND	-0.3V to (V _{CC} + 0.3V)	16-Pin TQFN (derate 17.5mW/°C)	1399mW
RXIN, XTAL1, XTAL2, SYNCOUT, RES to GND	-0.3V to +6V	Operating Temperature Range.....	-40°C to +105°C
TXIN, RXOUT, DIR, DIRMD1,		Junction Temperature.....	+150°C
DIRMD2 to GND.....	-0.3V to (V _L + 0.3V)	Storage Temperature Range	-65°C to +150°C
Output Short-Circuit Current TXOUT,		Lead Temperature (soldering, 10s)	+300°C
SYNCOUT to V _{CC} or GND.....	Continuous	Soldering Temperature (reflow)	+260°C

Stresses beyond those listed under "Absolute Maximum Ratings" may cause permanent damage to the device. These are stress ratings only, and functional operation of the device at these or any other conditions beyond those indicated in the operational sections of the specifications is not implied. Exposure to absolute maximum rating conditions for extended periods may affect device reliability.

Package Thermal Characteristics (Note 1)

TQFN

Junction-to-Ambient Thermal Resistance (θ _{JA}).....	57.2°C/W
Junction-to-Case Thermal Resistance (θ _{JC}).....	40°C/W

Note 1: Package thermal resistances were obtained using the method described in JEDEC specification JESD51-7, using a four-layer board. For detailed information on package thermal considerations, refer to www.maximintegrated.com/thermal-tutorial.

Electrical Characteristics

(V_{CC} = 5V, V_L = 3.3V, TXOUT connected with 50Ω to RXIN, 4.1kΩ resistor between BIAS and RES, 10kΩ resistor between RES and GND, 1kΩ resistor between SYNCOUT and V_{CC}, T_A = T_{MIN} to T_{MAX}, unless otherwise specified. XTAL frequency 8.704MHz ±30ppm. Typical values are at T_A = +25°C.) (Note 2)

PARAMETER	SYMBOL	CONDITION	MIN	TYP	MAX	UNITS
DC CHARACTERISTICS						
Supply Voltage	V _{CC}	Guaranteed by PSRR	3.0		5.5	V
Supply Current	I _{CC}	T _A ≤ 85°C		23	35	mA
		T _A > 85°C		27	40	
Logic Supply Voltage	V _L	Guaranteed by logic supply current	1.6		5.5	V
Logic Supply Current	I _L	V _{TXIN} = 3.3V		138	380	μA
Receiver Power-Supply Rejection Ratio	PSRR	3.0V ≤ V _{CC} ≤ 5.5V, V _{TXIN} = 3.3V (Note 3)	49	60		dB
Output Power-Supply Rejection Ratio		3.0V ≤ V _{CC} ≤ 5.5V, V _{TXIN} = 0V (Note 4)	49	60		dB
LOGIC INPUTS AND OUTPUTS						
Logic-Input High Threshold Voltage	V _{IH}	DIRMD1, DIRMD2, TXIN	0.7 x V _L			V
Logic-Input Low Threshold Voltage	V _{IL}	DIRMD1, DIRMD2, TXIN			0.3 x V _L	V
Logic-Output High Threshold Voltage	V _{OH}	RXOUT, DIR source 3.3mA	0.9 x V _L			V
Logic-Output Low Threshold Voltage	V _{OL}	RXOUT, DIR sink 3.3mA			0.1 x V _L	V
Input Leakage Current	I _{IH} , I _{IL}	TXIN shorted to GND or V _L			±1	μA
		DIRMD1, DIRMD2	Shorted to GND		-1	
			Shorted to V _L		+60	
SYNC INPUT (XTAL1) AND OUTPUT (SYNCOUT)						
Input High Threshold Voltage	V _{XTAL1_IH}		0.7 x V _{CC}			V

Electrical Characteristics (continued)

($V_{CC} = 5V$, $V_L = 3.3V$, TXOUT connected with 50Ω to RXIN, $4.1k\Omega$ resistor between BIAS and RES, $10k\Omega$ resistor between RES and GND, $1k\Omega$ resistor between SYNCOUT and V_{CC} , $T_A = T_{MIN}$ to T_{MAX} , unless otherwise specified. XTAL frequency $8.704MHz \pm 30ppm$. Typical values are at $T_A = +25^\circ C$.) (Note 2)

PARAMETER	SYMBOL	CONDITION	MIN	TYP	MAX	UNITS
Input Low Threshold Voltage	V_{XTAL1_IL}				$0.3 \times V_{CC}$	V
Input High Leakage Current	I_{XTAL1_IH}				10	μA
Input Low Leakage Current	I_{XTAL1_IL}				-10	μA
Output Low Voltage	$V_{SYNCOUT_OL}$	SYNCOUT source 3.3mA			0.4	V
RECEIVER FILTER						
Passband	f_{PB_L} , f_{PB_H}	Input amplitude $1.12V_{P-P}$ (the input carrier is recognized)	1.1		4.17	MHz
Extra Carrier Receiver Immunity	f_{IM1_L} , f_{IM1_H}	2.176MHz carrier amplitude ($112.4mV_{P-P} \pm 3dB$), extra carrier amplitude $0.8V_{P-P}$, $V_{DIRMD1} = V_{DIRMD2} = 0V$ (9.6kbps)	1.1		4.17	MHz
RECEIVER						
Input Voltage Range	V_{IN}	$V_{CC} = 3.0V$ to $5.5V$, $f_{RXIN} = 2.176MHz$			1.12	V_{P-P}
Equivalent Input Power Range	P_{IN}	$V_{CC} = 3.0V$ to $5.5V$, $f_{RXIN} = 2.176MHz$			+5	dBm
Input Impedance	Z_{IN}	$f = f_O$, $T_A \leq 85^\circ C$	11	18		k Ω
		$f = f_O$, $T_A > 85^\circ C$	9	18		
Threshold Voltage Range	V_{TH}	$f_{RXIN} = 2.176MHz$	-18	-15	-12	dBm
			79.72	112.4	158.48	mV $_{P-P}$
TRANSMITTER						
Output Frequency	f_O			2.176		MHz
Output Frequency Variation	Δf_O	(Note 5)			± 100	ppm
Output On Level at TXOUT (Note 6)	V_{OUT}	$V_{RES} = 1.5V$ (maximum)	11.1	12		dBm
		$V_{RES} = 0.7V$ (minimum)	2.24	2.52		V_{P-P}
Output Off Power Level at TXOUT (Note 6)	P_{OUT}	OOK off level				dBm
						-40
Output Emission Profile		(Note 7)				Conforms to AISG Spectrum Emissions Mask 3GPP TS 25.461, See Figure 3
Output Impedance	Z_{OUT}	DC		0.03		Ω
		$f_{SW} = 10MHz$		2.5		
Amplifier Gain Bandwidth	GBW			54		MHz
TXOUT Short-Circuit Protection	I_{SC}	Short to GND or V_{CC} , guaranteed over V_{CC} range			± 200	mA

Electrical Characteristics (continued)

(V_{CC} = 5V, V_L = 3.3V, TXOUT connected with 50Ω to RXIN, 4.1kΩ resistor between BIAS and RES, 10kΩ resistor between RES and GND, 1kΩ resistor between SYNCOUT and V_{CC}, T_A = T_{MIN} to T_{MAX}, unless otherwise specified. XTAL frequency 8.704MHz ±30ppm. Typical values are at T_A = +25°C.) (Note 2)

PARAMETER	SYMBOL	CONDITION	MIN	TYP	MAX	UNITS
SWITCHING CHARACTERISTICS						
Receiver Propagation Delay	t _{RX}	RXIN to RXOUT, V _{DIRMD1} = V _{DIRMD2} = 0V		8.9	11	μs
		RXIN to RXOUT, V _{DIRMD1} = 3.3V, V _{DIRMD2} = 0V (38.4kbps), V _{DIRMD1} = 0V, V _{DIRMD2} = 3.3V (115.2kbps)		5.5	11	
Receiver Output Rise and Fall Time	t _R , t _F	10% to 90%, R _L = 1kΩ, C _L = 10pF		20		ns
Transmitter Propagation Delay	t _{TX}	TXIN to TXOUT			5	μs
DIR to RXOUT Delay (Note 8)	t _{DIR, SKEW}		270			ns
Direction Duration High	t _{DIR, HIGH}	V _{DIRMD1} = V _{DIRMD2} = 0V (9.6kbps)		1667		μs
		V _{DIRMD1} = 3.3V, V _{DIRMD2} = 0V (38.4kbps)		417		
		V _{DIRMD1} = 0V, V _{DIRMD2} = 3.3V (115.2kbps)		137		
Receiver Output Data Duty-Cycle Variation	ΔDC	RXIN fed by an OOK 2.176MHz sinusoidal signal with 50% duty cycle (Note 9)	RXIN = 0dBm	-7.5	±10	%
			RXIN = -10dBm	+2	±10	

Note 2: All devices are 100% production tested at T_A = +25°C. Specification over temperature limits are guaranteed by design.

Note 3: Defined as ΔV_{RXIN}/ΔV_{CC} at DC.

Note 4: Defined as ΔV_{TXOUT}/ΔV_{CC} at DC.

Note 5: Output frequency variation determined by external crystal tolerance.

Note 6: See the *Transmission Output Power* section for external resistor values.

Note 7: Guaranteed by design with a recommended 470pF capacitor between RXIN and ground. Measurements above 150MHz are determined by setup.

Note 8: See Figure 1.

Note 9: ±2μs envelope rise/fall.

Typical Operating Characteristics

($V_{CC} = 5V$, $V_L = 3.3V$, TXOUT connected with 50Ω to RXIN, RXIN connected to 50Ω in series with $220nF$ to GND, $R1 = 10k\Omega$ between BIAS and RES, $R2 = \infty$, pullup SYNCOUT with $1k\Omega$ to V_L , $T_A = T_{MIN}$ to T_{MAX} , unless otherwise specified.)

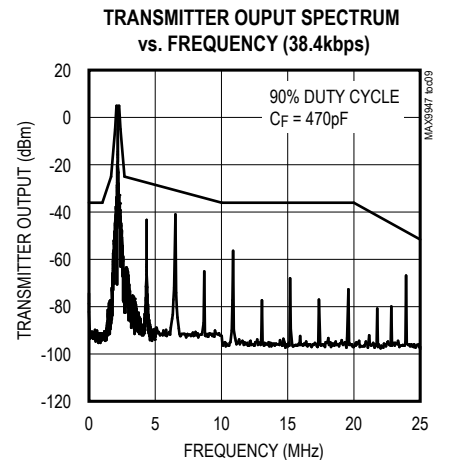
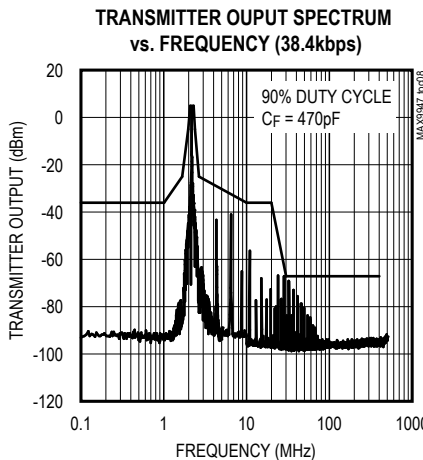
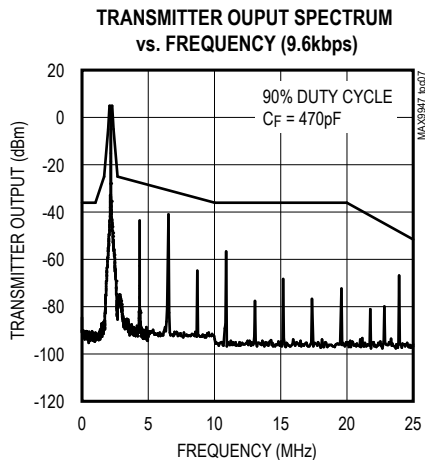
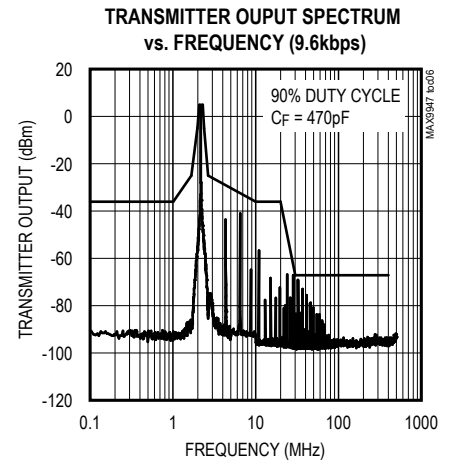
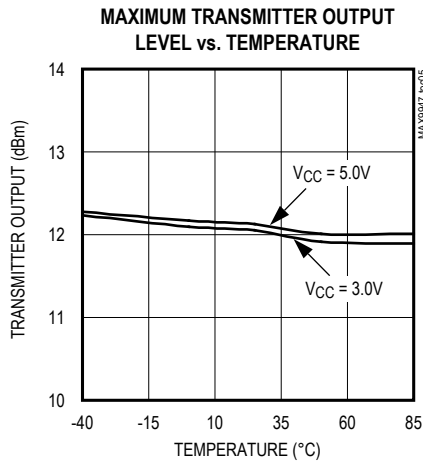
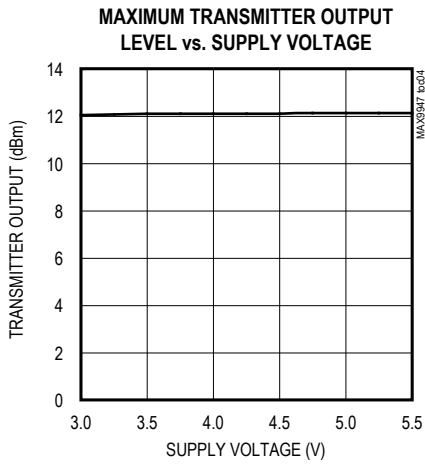
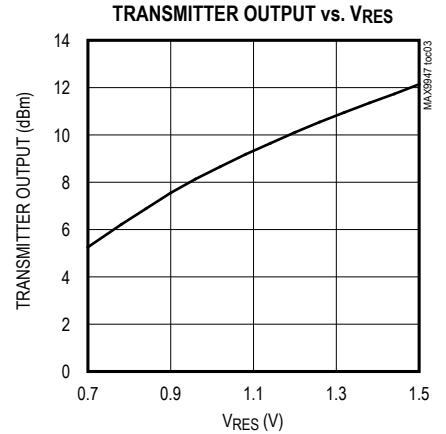
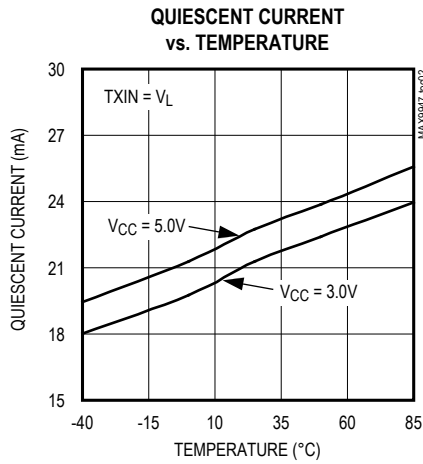
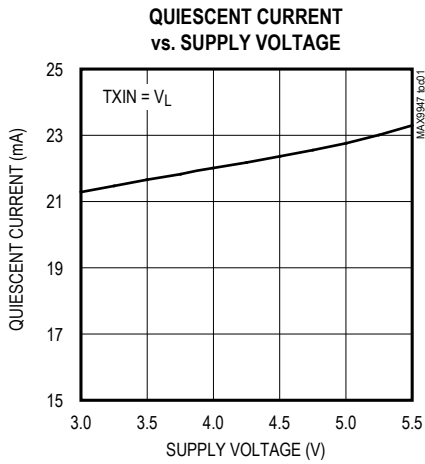

Typical Operating Characteristics (continued)

($V_{CC} = 5V$, $V_L = 3.3V$, TXOUT connected with 50Ω to RXIN, RXIN connected to 50Ω in series with $220nF$ to GND, $R1 = 10k\Omega$ between BIAS and RES, $R2 = \infty$, pullup SYNCOUT with $1k\Omega$ to V_L , $T_A = T_{MIN}$ to T_{MAX} , unless otherwise specified.)

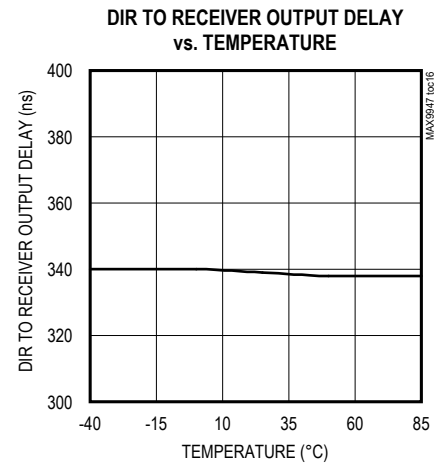
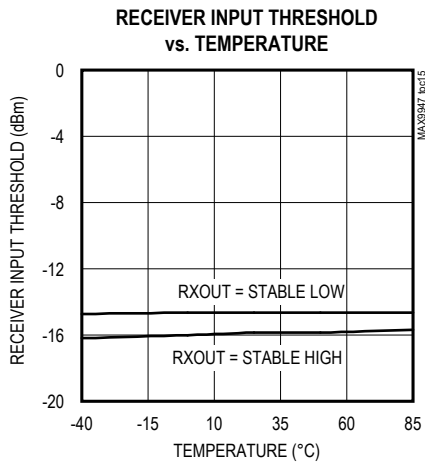
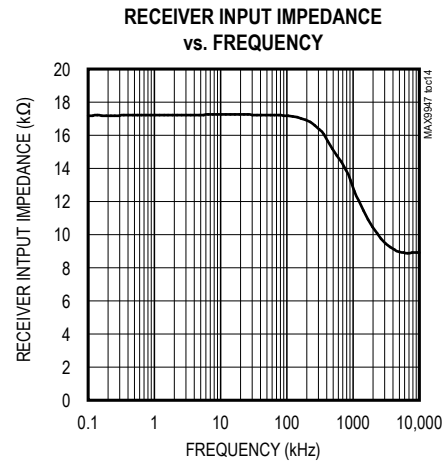
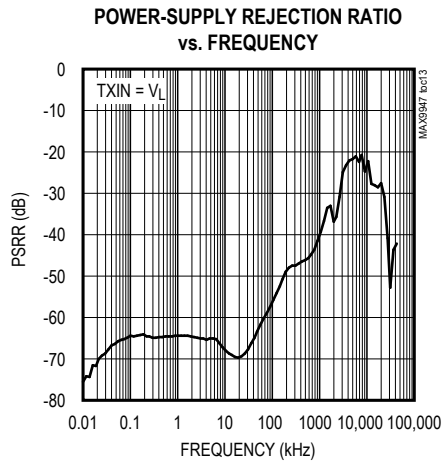
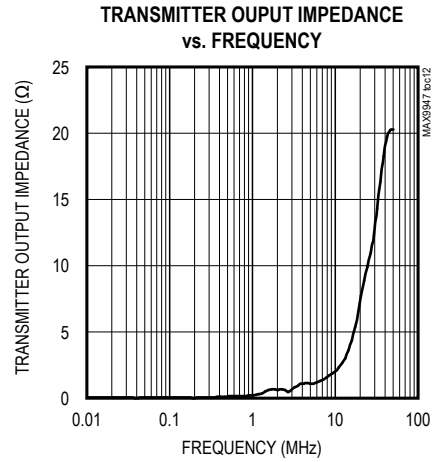
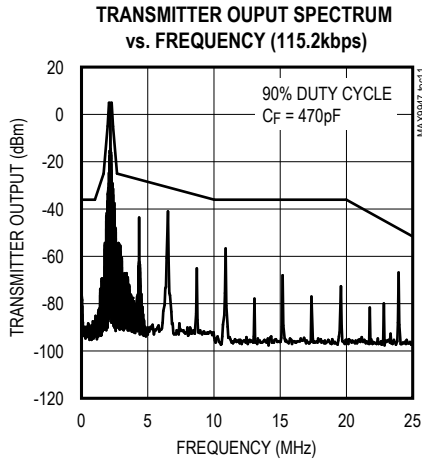
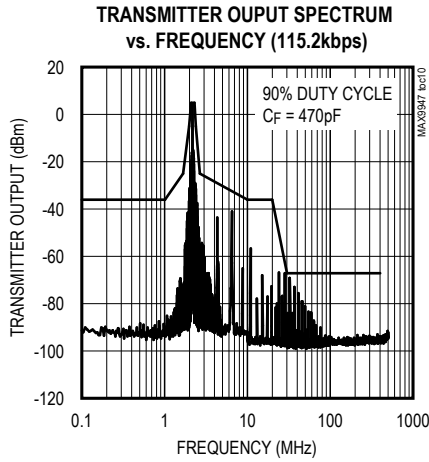

Typical Operating Characteristics

($V_{CC} = 5V$, $V_L = 3.3V$, TXOUT connected with 50Ω to RXIN, RXIN connected to 50Ω in series with $220nF$ to GND, $R1 = 10k\Omega$ between BIAS and RES, $R2 = \infty$, pullup SYNCOUT with $1k\Omega$ to V_L , $T_A = T_{MIN}$ to T_{MAX} , unless otherwise specified.)

TRANSMITTER PROPAGATION DELAY AT 9.6kbps

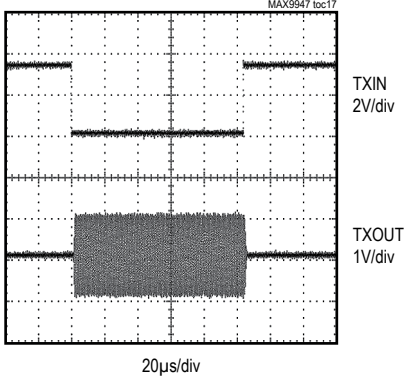

TRANSMITTER PROPAGATION DELAY AT 115.2kbps

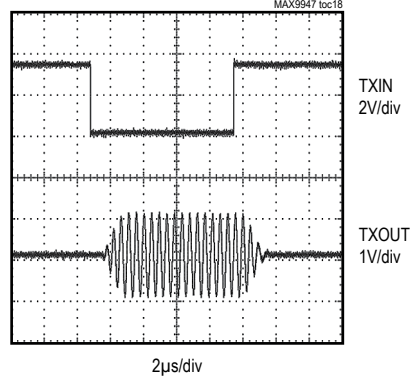

RECEIVER PROPAGATION DELAY AT 9.6kbps

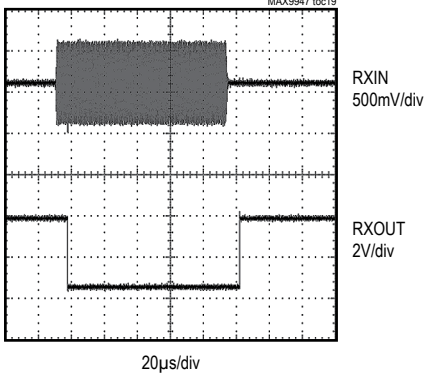

RECEIVER PROPAGATION DELAY AT 115.2kbps

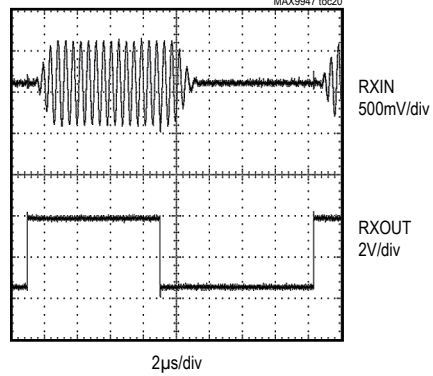

RECEIVER OUTPUT TO DIR AT 9.6kbps

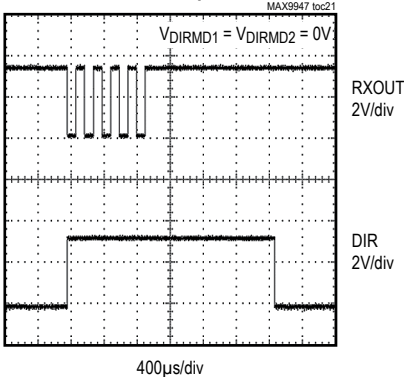

RECEIVER OUTPUT TO DIR AT 38.4kbps

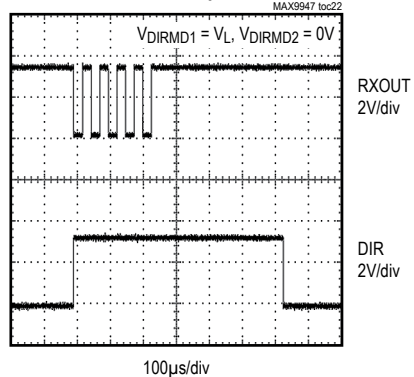

Typical Operating Characteristics (continued)

($V_{CC} = 5V$, $V_L = 3.3V$, TXOUT connected with 50Ω to RXIN, RXIN connected to 50Ω in series with $220nF$ to GND, $R_1 = 10k\Omega$ between BIAS and RES, $R_2 = \infty$, pullup SYNCOUT with $1k\Omega$ to V_L , $T_A = T_{MIN}$ to T_{MAX} , unless otherwise specified.)

**RECEIVER OUTPUT TO DIR
AT 115.2kbps**

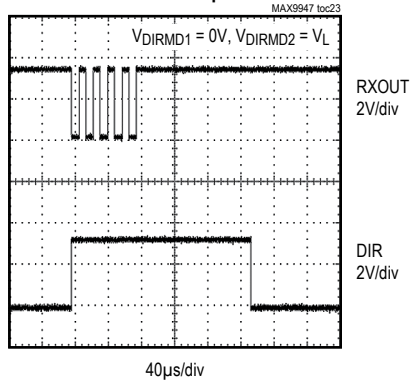

DIR TO RECEIVER OUTPUT

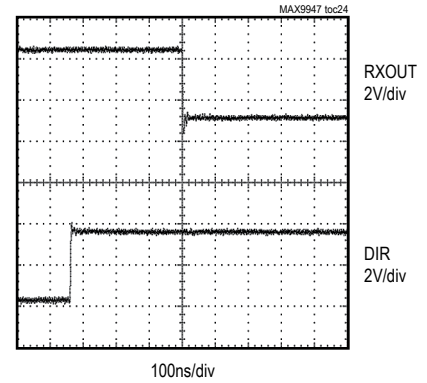

**RECEIVER OUTPUT DUTY CYCLE
vs. RECEIVER INPUT (9.6kbps)**

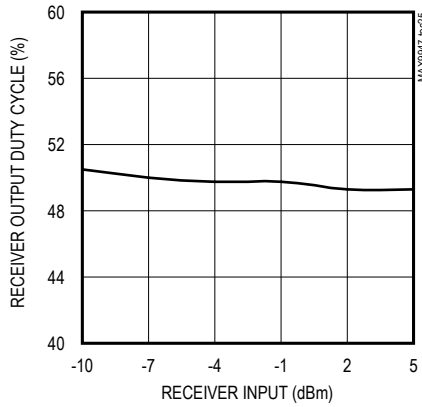

**RECEIVER OUTPUT DUTY CYCLE
vs. RECEIVER INPUT (115.2kbps)**

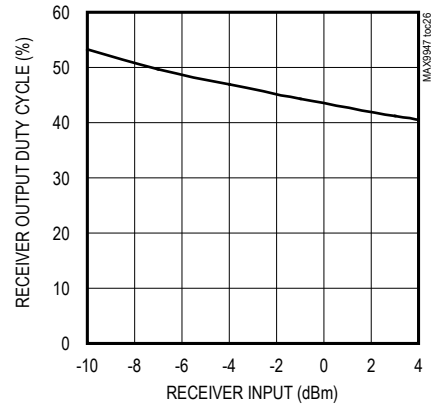

**RECEIVER OUTPUT DUTY CYCLE
(9.6kbps)**

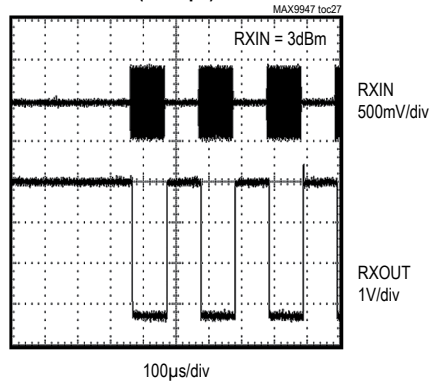

Pin Configuration

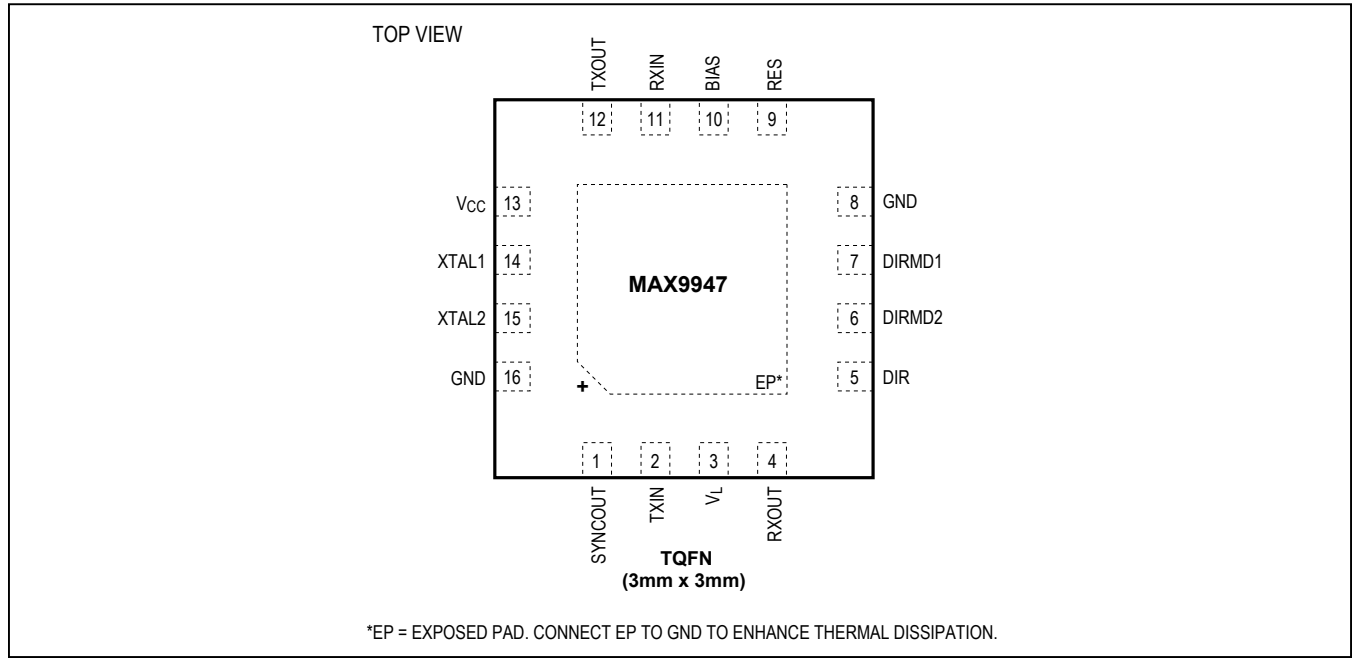

Pin Description

PIN	NAME	FUNCTION
1	SYNCOUT	Sync Output. Open-drain output that outputs the 8.704MHz clock to synchronize other devices.
2	TXIN	Digital Signal Input
3	VL	Logic Supply Voltage
4	RXOUT	Digital Signal Output
5	DIR	Direction Output. DIR is asserted high when the data stream is seen at the receiver (RXIN).
6	DIRMD2	Duration Mode Select Input 2
7	DIRMD1	Duration Mode Select Input 1
8, 16	GND	Ground
9	RES	External Resistors' Connection to Set the Output Power Level
10	BIAS	Output Bias Reference. Used with RES to set the output power level. Decouple BIAS with 1µF to GND.
11	RXIN	OOK-Modulated Input Signal
12	TXOUT	OOK-Modulated Output Signal
13	VCC	Analog Supply Voltage
14	XTAL1	External Crystal Input Terminal. Feed with 8.704MHz (±30ppm) input clock for external synchronization.
15	XTAL2	External Crystal Input Terminal. Connect to GND for external synchronization.
—	EP	Exposed Pad. Connect EP to GND to enhance thermal dissipation.

Detailed Description

The MAX9947 is an AISG-compliant, fully integrated transceiver.

The MAX9947 transmitter includes an OOK modulator, a bandpass filter that is compliant with the AISG spectrum emission profile, and an output amplifier. The output power can be varied with external resistors from +7dBm to +12dBm (+1dBm to +6dBm at the feeder cable) to compensate for loss in the external circuitry and cabling. The OOK carrier is generated by applying an external crystal at 8.704MHz to the OOK internal modulator through the XTAL1 and XTAL2 pins. An external clock source at the same frequency can also be applied to XTAL1 by connecting XTAL2 to ground.

The MAX9947 receiver includes a narrow 200kHz bandwidth bandpass filter that operates around the 2.176MHz center frequency. It also includes an OOK demodulator and a comparator that reconstruct the digital signal. The minimum sensitivity of the receiver is -15dBm (typ) in compliance with the AISG standard specifications.

The MAX9947 also features a direction output to facilitate the RS-485 bus arbitration in tower-mounted equipment.

Direction Output

The MAX9947 provides a direction output pin (DIR) that indicates the direction of the data flow. This feature is very useful in the tower that acts as a slave in the AISG

protocol. The base is the master and it controls the flow of the data by performing the bus arbitration. The output DIR allows the equipment in the tower to avoid any involvement in the bus arbitration. See the [Typical Application Circuit \(Connectivity at the Tower\)](#) that shows how the MAX9947 can be used in the tower in conjunction with the RS-485 transceiver such as the MAX13485E or MAX13486E.

The output DIR drives the DE (driver output enable) and RE_ (receiver output enable) of the RS-485 transceiver.

Whenever the data flows from RXIN to RXOUT, the output DIR is asserted high. When the MAX9947 is located in the tower, the data flow is being sent from the base (master) to the tower (slave). On the other side, when the data flows in the opposite direction, from TXIN to TXOUT the output DIR is asserted low. However, the MAX9947 internal state machine is sensing both the TXIN and RXIN lines, and can recognize the correct flow of data and avoid asserting the DIR high.

[Figure 1](#) and [Figure 2](#) show the timing diagrams of the DIR functionality. When the data flows from RXIN to RXOUT, DIR remains high for 16 bit-times after the last logic-level low bit within the 8-bit protocol data. This is compliant with the AISG specification saying that the RS-485 transmitter stops driving the bus within 20 bit-times after the last stop bit is sent.

The input pins DIRMD2 and DIRMD1 define the duration of the bit time, as shown in [Table 1](#).

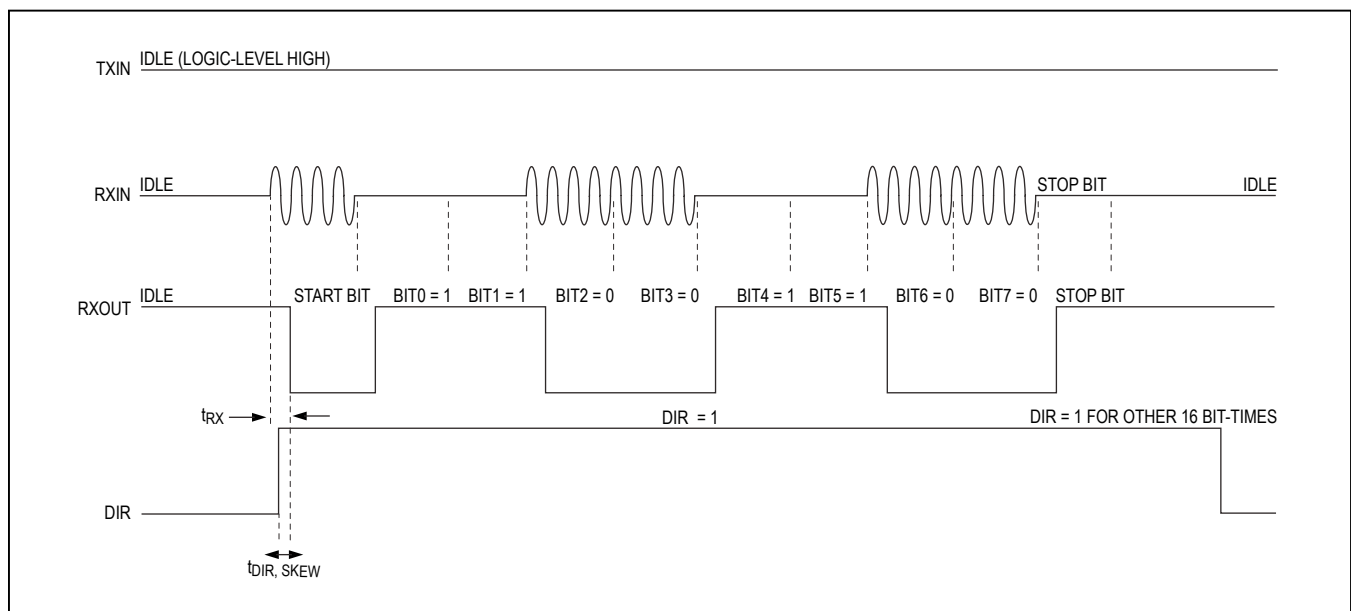

Figure 1. The MAX9947 on the Tower: Communication Flow is from the Base to the Tower

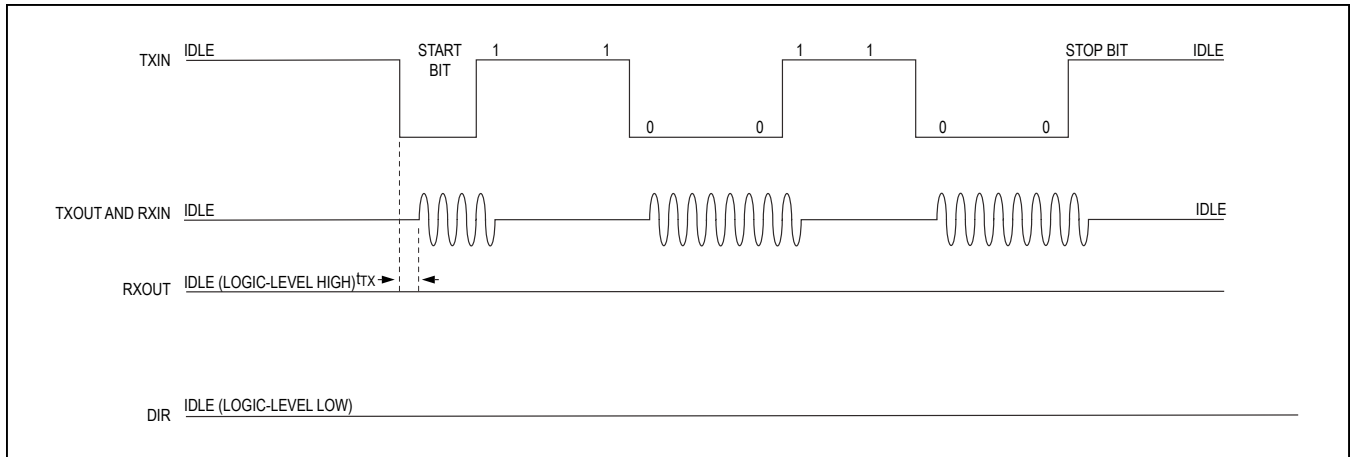

Figure 2. The MAX9947 on the Tower: Communication Flow is from the Tower to the Base

Table 1. Bit-Time Duration Selector

DIRMD2*	DIRMD1*	AISG DATA RATE (kbps)	UNITY BIT TIME (μs)
0	0	9.6	104.16
0	1	38.4	26.04
1	0	115.2	8.68
1	1	Not used	Not used

*DIRMD1 and DIRMD2 are internally pulled down.

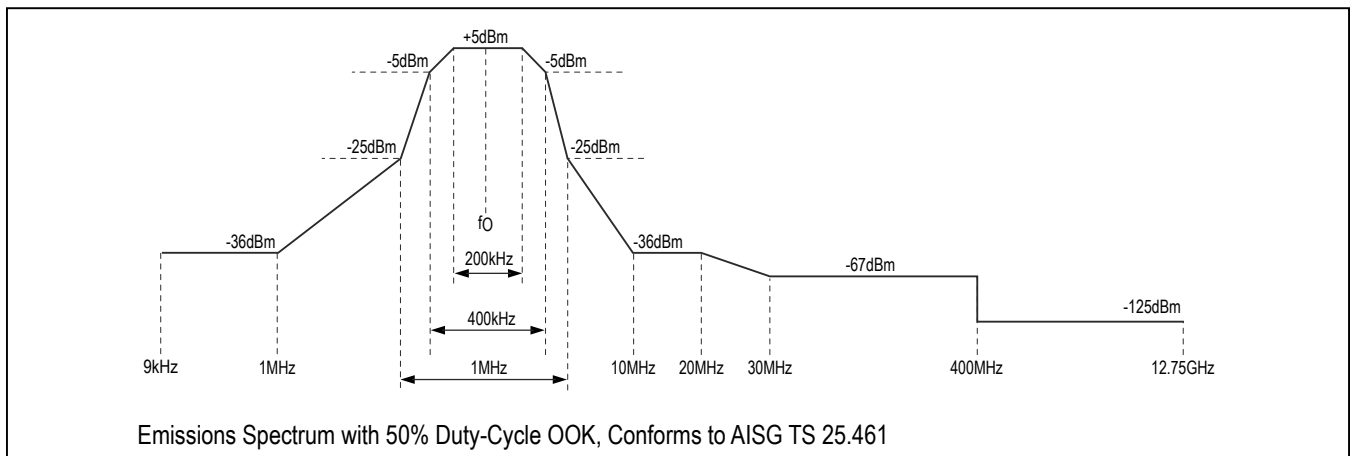

Figure 3. AISG Standard Modem Spectrum Emission Mask

Applications Information

Emission Output Profile

The AISG standard defines the maximum spectrum emission that all the OOK modulating devices must be compliant with. Such a spectrum is represented in [Figure 3](#).

The MAX9947 is compliant with the AISG standard.

An external 470pF capacitor connected between RXIN and ground is recommended for compliance above 25MHz (see the [Typical Application Circuit \(Connectivity at the Base\)](#) and [Typical Application Circuit \(Connectivity at the Tower\)](#)).

External Termination and AC-Coupling to Feeder Cable

The MAX9947 transceiver works in conjunction with an external 50 Ω termination. The termination is connected serially between TXOUT and the feeder cable. It acts as series termination for the transmitting path (data flowing from TXIN to TXOUT) and acts as parallel termination when data is being received on RXIN.

The output of the transmitter is biased at 1.5V to maximize the power-supply rejection ratio and minimize the emission. It is recommended that the device be AC-coupled to the feeder cable through either an external RF filter or a series 100nF capacitor.

Transmission Output Power

The MAX9947 output level at TXOUT can be set by using two external resistors that connect at the RES and BIAS pins as shown in the [Typical Application Circuit \(Connectivity at the Base\)](#) and [Typical Application Circuit \(Connectivity at the Tower\)](#). The maximum voltage at TXOUT is 2.52V_{P-P}. Assuming that the feeder cable is terminated into a 50 Ω impedance, the external filter is lossless at 2.176MHz, and a series 50 Ω termination is being used as in the [Typical Application Circuit \(Connectivity at the Base\)](#) and [Typical Application Circuit \(Connectivity at the Tower\)](#), the output level of 2.52V_{P-P} corresponds to +6dBm at the feeder cable.

The TXOUT voltage level can be varied according to the following equations:

$$V_{TXOUT} (V_{P-P}) = (2.52V_{P-P} \times V_{RES} (V)) / 1.5V$$

$$V_{RES} (V) = 1.5V \times R2 / (R1 + R2)$$

$$V_{TXOUT} (V_{P-P}) = 2.52V_{P-P} \times R2 / (R1 + R2)$$

Use $R1 = 0\Omega$ for maximum voltage level of 2.52V_{P-P}.

The voltage at the RES pin must be between 0.84V and 1.5V. It implies that the minimum voltage level at TXOUT is approximately 1.41V that corresponds to +1dBm at the feeder cable. It is recommended that a 1 μ F capacitor be connected between the BIAS pin and ground.

To obtain the nominal power level of +3dBm at the feeder cable as the AISG standard requires, use $R1 = 4.1k\Omega$ and $R2 = 10k\Omega$ that provide 1.78V_{P-P} at TXOUT.

The MAX9947 can provide up to 2.52V_{P-P} to compensate for potential loss within the external filter, cable, connections, and termination.

Receiver-Input Range and Threshold

The maximum OOK input power at RXIN into the 50 Ω external termination is +5dBm. For a single-tone signal at 2.176MHz, 5dBm corresponds to 1.12V_{P-P}.

The MAX9947 internal threshold is -15dBm (112.4mV_{P-P}) with ± 3 dB accuracy in compliance with the AISG standard specifications. This threshold sets the minimum input signal level that is recognized as OOK carrier being present (level logic-low).

Consider a corner case where the OOK signal at 2.176MHz present at the RXIN pin is at the minimum level of -15dBm ± 3 dB. To avoid the saturation of the receiver input stage, any other adjacent carrier with power-up to +5dBm must be either below 1.1MHz or above 4.5MHz.

External Clock

The MAX9947 integrated AISG transceiver operates with an external crystal at 4x the 2.176MHz frequency, or 8.704MHz. The crystal is required to achieve the ± 100 ppm frequency stability specification of the AISG standard. A crystal with ± 30 ppm is recommended along with two 40pF ($\pm 10\%$ tolerance) capacitors connected to ground as shown in [Typical Application Circuit \(Connectivity at the Base\)](#) and [Typical Application Circuit \(Connectivity at the Tower\)](#). The capacitors do not affect the oscillation frequency.

Multiple MAX9947 devices can share the same crystal by using the SYNCOUT pin. One device acts as a master and provides the 8.704MHz clock signal to the slave device(s) through such a pin. To configure a device as a slave, XTAL2 should be connected to ground. The external clock coming from the master device feeds the XTAL1 pin of the slave device through a series 10k Ω resistor.

Connect a 1k Ω pullup resistor to V_{CC} from the SYNCOUT pin of the master device.

Typical Application Circuit (Connectivity at the Base)

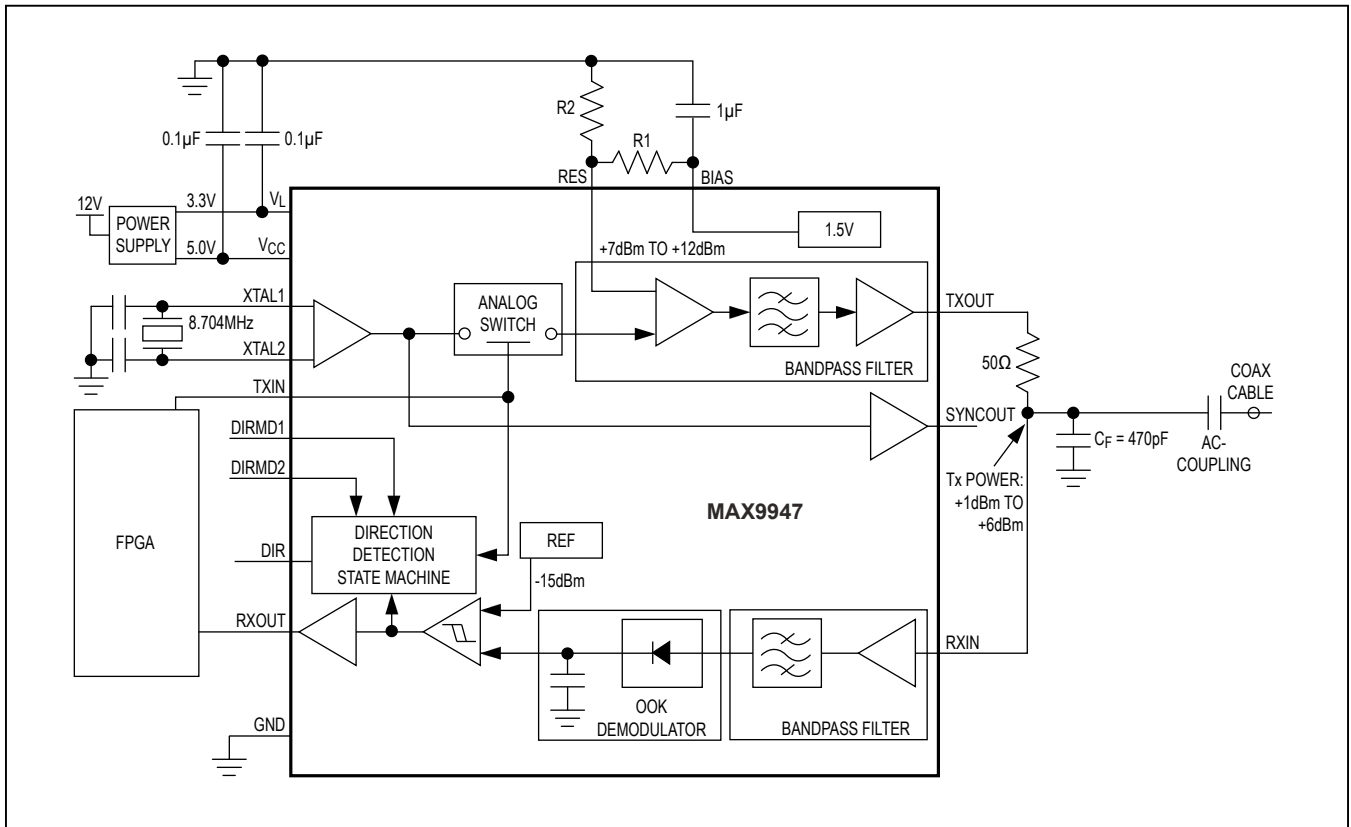

Typical Application Circuit (Connectivity at the Tower)

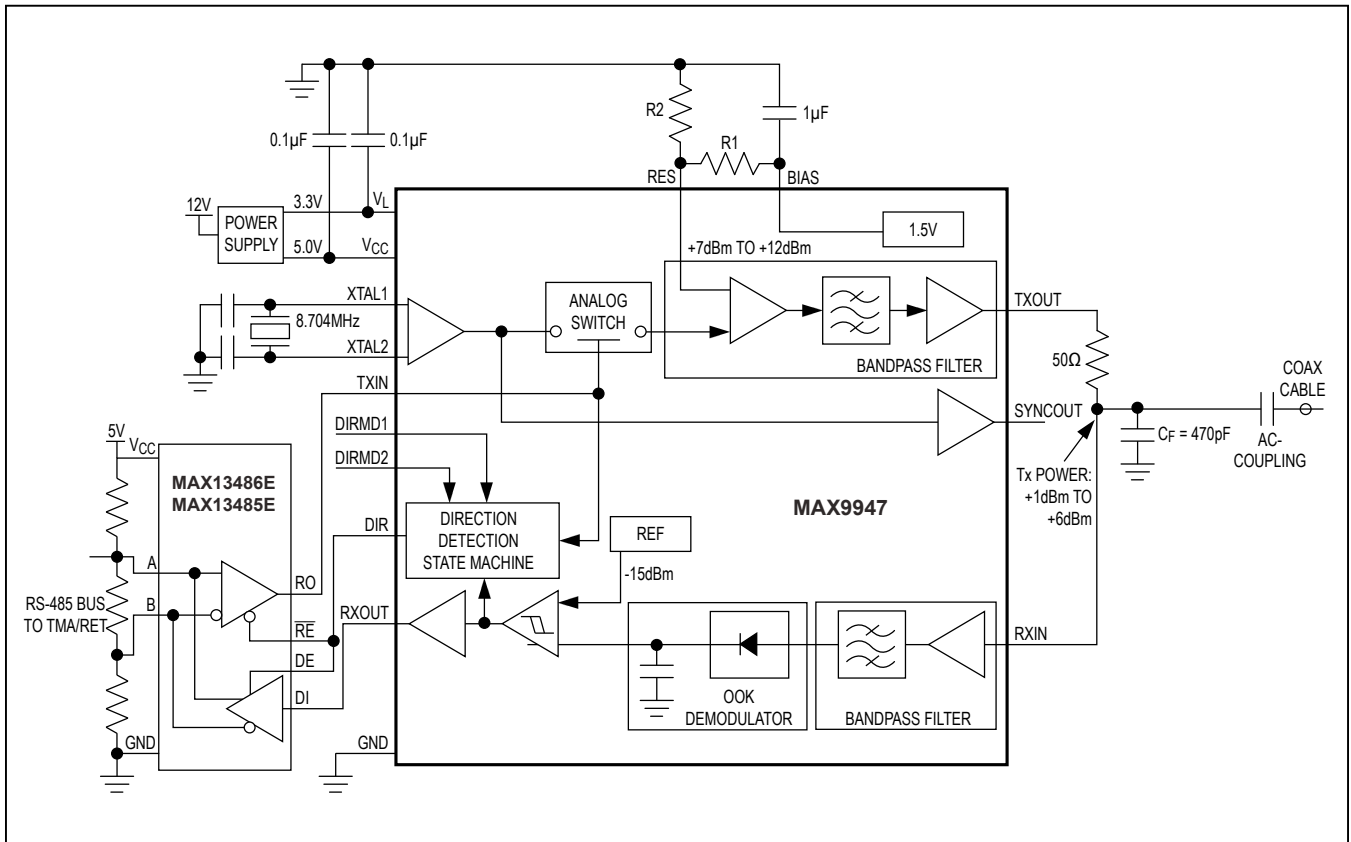

Chip Information

PROCESS: BiCMOS

Package Information

For the latest package outline information and land patterns (footprints), go to www.maximintegrated.com/packages. Note that a "+", "#", or "-" in the package code indicates RoHS status only. Package drawings may show a different suffix character, but the drawing pertains to the package regardless of RoHS status.

PACKAGE TYPE	PACKAGE CODE	OUTLINE NO.	LAND PATTERN NO.
16 TQFN-EP	T1633F+3	21-0136	90-0033

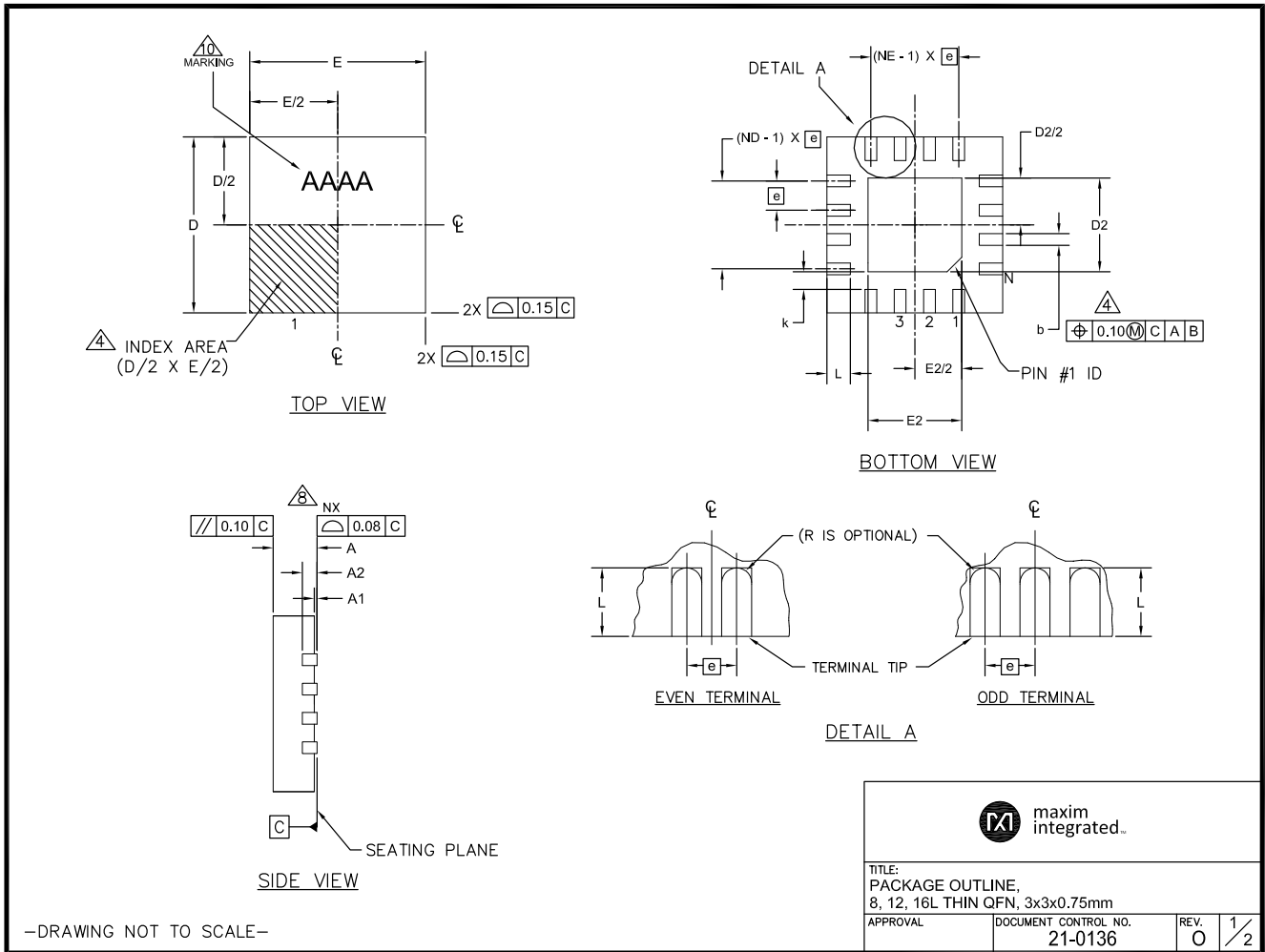

Package Information (continued)

For the latest package outline information and land patterns (footprints), go to www.maximintegrated.com/packages. Note that a "+", "#", or "-" in the package code indicates RoHS status only. Package drawings may show a different suffix character, but the drawing pertains to the package regardless of RoHS status.

PKG REF.	8L 3x3			12L 3x3			16L 3x3		
	MIN.	NOM.	MAX.	MIN.	NOM.	MAX.	MIN.	NOM.	MAX.
A	0.70	0.75	0.80	0.70	0.75	0.80	0.70	0.75	0.80
b	0.25	0.30	0.35	0.20	0.25	0.30	0.20	0.25	0.30
D	2.90	3.00	3.10	2.90	3.00	3.10	2.90	3.00	3.10
E	2.90	3.00	3.10	2.90	3.00	3.10	2.90	3.00	3.10
e	0.65 BSC.			0.50 BSC.			0.50 BSC.		
L	0.35	0.55	0.75	0.45	0.55	0.65	0.30	0.40	0.50
N	8			12			16		
ND	2			3			4		
NE	2			3			4		
A1	0	0.02	0.05	0	0.02	0.05	0	0.02	0.05
A2	0.20 REF			0.20 REF			0.20 REF		
k	0.25	-	-	0.25	-	-	0.25	-	-

PKG. CODES	EXPOSED PAD VARIATIONS						PIN ID	JEDEC
	D2			E2				
	MIN.	NOM.	MAX.	MIN.	NOM.	MAX.		
TQ833-1	0.25	0.70	1.25	0.25	0.70	1.25	0.35 x 45°	WEEC
T1233-1	0.95	1.10	1.25	0.95	1.10	1.25	0.35 x 45°	WEED-1
T1233-3	0.95	1.10	1.25	0.95	1.10	1.25	0.35 x 45°	WEED-1
T1633-2	0.95	1.10	1.25	0.95	1.10	1.25	0.35 x 45°	WEED-2
T1633-2C	0.95	1.10	1.25	0.95	1.10	1.25	0.35 x 45°	WEED-2
T1633F-3	0.65	0.80	0.95	0.65	0.80	0.95	0.225 x 45°	WEED-2
T1633FH-3	0.65	0.80	0.95	0.65	0.80	0.95	0.225 x 45°	WEED-2
T1633-4	0.95	1.10	1.25	0.95	1.10	1.25	0.35 x 45°	WEED-2
T1633-4C	0.95	1.10	1.25	0.95	1.10	1.25	0.35 x 45°	WEED-2
T1633MK-5	0.95	1.10	1.25	0.95	1.10	1.25	0.35 x 45°	WEED-2

PKG. CODES	EXPOSED PAD VARIATIONS									PIN ID
	D2			E2			L			
	MIN.	NOM.	MAX.	MIN.	NOM.	MAX.	MIN.	NOM.	MAX.	
T1233-4	0.95	1.10	1.25	0.95	1.10	1.25	0.35	0.45	0.55	0.35 x 45°
T1633-5	0.95	1.10	1.25	0.95	1.10	1.25	0.25	0.35	0.45	0.35 x 45°
T1633-5C	0.95	1.10	1.25	0.95	1.10	1.25	0.25	0.35	0.45	0.35 x 45°

NOTES:

- DIMENSIONING & TOLERANCING CONFORM TO ASME Y14.5M-1994.
- ALL DIMENSIONS ARE IN MILLIMETERS. ANGLES ARE IN DEGREES.
- N IS THE TOTAL NUMBER OF TERMINALS.
- THE TERMINAL #1 IDENTIFIER AND TERMINAL NUMBERING CONVENTION SHALL CONFORM TO JESD 95-1 SPP-012. DETAILS OF TERMINAL #1 IDENTIFIER ARE OPTIONAL, BUT MUST BE LOCATED WITHIN THE ZONE INDICATED. THE TERMINAL #1 IDENTIFIER MAY BE EITHER A MOLD OR MARKED FEATURE.
- DIMENSION b APPLIES TO METALLIZED TERMINAL AND IS MEASURED BETWEEN 0.20 mm AND 0.25 mm FROM TERMINAL TIP.
- ND AND NE REFER TO THE NUMBER OF TERMINALS ON EACH D AND E SIDE RESPECTIVELY.
- DEPOPULATION IS POSSIBLE IN A SYMMETRICAL FASHION.
- COPLANARITY APPLIES TO THE EXPOSED HEAT SINK SLUG AS WELL AS THE TERMINALS.
- DRAWING CONFORMS TO JEDEC MO220 REVISION C. T1233-4, T1633-5 AND T1633-5C WITH CUSTOM LEAD DIMENSION.
- MARKING SHOWN IS FOR PACKAGE ORIENTATION REFERENCE ONLY.
- NUMBER OF LEADS SHOWN ARE FOR REFERENCE ONLY.
- WARPAGE NOT TO EXCEED 0.10mm.
- ALL DIMENSIONS APPLY TO BOTH LEADED (-) AND Pb FREE (+) PARTS.

-DRAWING NOT TO SCALE-

			
TITLE: PACKAGE OUTLINE, 8, 12, 16L THIN QFN, 3x3x0.75mm			
APPROVAL	DOCUMENT CONTROL NO.	REV.	2/2
	21-0136	O	

Revision History

REVISION NUMBER	REVISION DATE	DESCRIPTION	PAGES CHANGED
0	12/09	Initial release	—
1	9/10	Corrected Figures 1 and 3, added soldering temperature	2, 10, 11
2	6/11	Changed top mark in <i>Ordering Information</i>	1
3	7/11	Added θ_{JA} and θ_{JC} data	2
4	4/16	Updated <i>Electrical Characteristics</i> and <i>Ordering Information</i> tables, Figure 3	1–4, 11, 15, 16

For pricing, delivery, and ordering information, please contact Maxim Direct at 1-888-629-4642, or visit Maxim Integrated's website at www.maximintegrated.com.

Maxim Integrated cannot assume responsibility for use of any circuitry other than circuitry entirely embodied in a Maxim Integrated product. No circuit patent licenses are implied. Maxim Integrated reserves the right to change the circuitry and specifications without notice at any time. The parametric values (min and max limits) shown in the *Electrical Characteristics* table are guaranteed. Other parametric values quoted in this data sheet are provided for guidance.

Mouser Electronics

Authorized Distributor

Click to View Pricing, Inventory, Delivery & Lifecycle Information:

[Maxim Integrated:](#)

[MAX9947ETE+](#) [MAX9947ETE+T](#)