

**SMPS MOSFET**

**IRF7478PbF**

HEXFET® Power MOSFET

**Applications**

- High frequency DC-DC converters
- Lead-Free

$V_{DSS}$	$R_{DS(on)}$ max (m $\Omega$ )	$I_D$
<b>60V</b>	26 @ $V_{GS} = 10V$	4.2A
	30 @ $V_{GS} = 4.5V$	3.5A

**Benefits**

- Low Gate to Drain Charge to Reduce Switching Losses
- Fully Characterized Capacitance Including Effective  $C_{OSS}$  to Simplify Design, (See App. Note AN1001)
- Fully Characterized Avalanche Voltage and Current

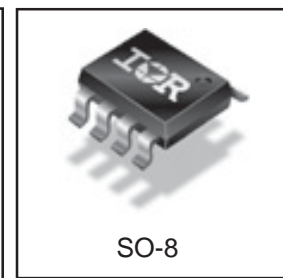
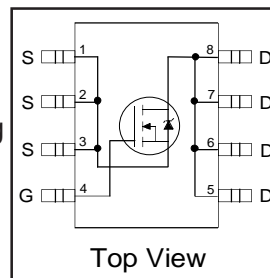

**Absolute Maximum Ratings**

	Parameter	Max.	Units
$I_D$ @ $T_A = 25^\circ C$	Continuous Drain Current, $V_{GS}$ @ 10V	7.0	A
$I_D$ @ $T_A = 70^\circ C$	Continuous Drain Current, $V_{GS}$ @ 10V	5.6	
$I_{DM}$	Pulsed Drain Current ①	56	
$P_D$ @ $T_A = 25^\circ C$	Power Dissipation ②	2.5	W
	Linear Derating Factor	0.02	W/ $^\circ C$
$V_{GS}$	Gate-to-Source Voltage	$\pm 20$	V
dv/dt	Peak Diode Recovery dv/dt ③	3.7	V/ns
$T_J$	Operating Junction and Storage Temperature Range	-55 to + 150	$^\circ C$
$T_{STG}$			
	Soldering Temperature, for 10 seconds	300 (1.6mm from case )	

**Thermal Resistance**

Symbol	Parameter	Typ.	Max.	Units
$R_{\theta JL}$	Junction-to-Drain Lead	—	20	$^\circ C/W$
$R_{\theta JA}$	Junction-to-Ambient ④	—	50	

Notes ① through ⑥ are on page 8  
www.irf.com

# IRF7478PbF

International  
**IR** Rectifier

## Static @ T<sub>J</sub> = 25°C (unless otherwise specified)

	Parameter	Min.	Typ.	Max.	Units	Conditions
V <sub>(BR)DSS</sub>	Drain-to-Source Breakdown Voltage	60	—	—	V	V <sub>GS</sub> = 0V, I <sub>D</sub> = 250μA
ΔV <sub>(BR)DSS</sub> /ΔT <sub>J</sub>	Breakdown Voltage Temp. Coefficient	—	0.065	—	V/°C	Reference to 25°C, I <sub>D</sub> = 1mA
R <sub>DS(on)</sub>	Static Drain-to-Source On-Resistance	—	20	26	mΩ	V <sub>GS</sub> = 10V, I <sub>D</sub> = 4.2A ③
		—	23	30		V <sub>GS</sub> = 4.5V, I <sub>D</sub> = 3.5A ③
V <sub>GS(th)</sub>	Gate Threshold Voltage	1.0	—	3.0	V	V <sub>DS</sub> = V <sub>GS</sub> , I <sub>D</sub> = 250μA
I <sub>DSS</sub>	Drain-to-Source Leakage Current	—	—	20	μA	V <sub>DS</sub> = 48V, V <sub>GS</sub> = 0V
		—	—	100		V <sub>DS</sub> = 48V, V <sub>GS</sub> = 0V, T <sub>J</sub> = 125°C
I <sub>GSS</sub>	Gate-to-Source Forward Leakage	—	—	100	nA	V <sub>GS</sub> = 20V
	Gate-to-Source Reverse Leakage	—	—	-100		V <sub>GS</sub> = -20V

## Dynamic @ T<sub>J</sub> = 25°C (unless otherwise specified)

	Parameter	Min.	Typ.	Max.	Units	Conditions
g <sub>fs</sub>	Forward Transconductance	17	—	—	S	V <sub>DS</sub> = 50V, I <sub>D</sub> = 4.2A
Q <sub>g</sub>	Total Gate Charge	—	21	31	nC	I <sub>D</sub> = 4.2A
Q <sub>gs</sub>	Gate-to-Source Charge	—	4.3	—		V <sub>DS</sub> = 48V
Q <sub>gd</sub>	Gate-to-Drain ("Miller") Charge	—	9.6	—		V <sub>GS</sub> = 4.5V
t <sub>d(on)</sub>	Turn-On Delay Time	—	7.7	—	ns	V <sub>DD</sub> = 30V
t <sub>r</sub>	Rise Time	—	2.6	—		I <sub>D</sub> = 4.2A
t <sub>d(off)</sub>	Turn-Off Delay Time	—	44	—		R <sub>G</sub> = 6.2Ω
t <sub>f</sub>	Fall Time	—	13	—		V <sub>GS</sub> = 10V ③
C <sub>iss</sub>	Input Capacitance	—	1740	—		V <sub>GS</sub> = 0V
C <sub>oss</sub>	Output Capacitance	—	300	—	pF	V <sub>DS</sub> = 25V
C <sub>rss</sub>	Reverse Transfer Capacitance	—	37	—		f = 1.0MHz
C <sub>oss</sub>	Output Capacitance	—	1590	—		V <sub>GS</sub> = 0V, V <sub>DS</sub> = 1.0V, f = 1.0MHz
C <sub>oss</sub>	Output Capacitance	—	220	—		V <sub>GS</sub> = 0V, V <sub>DS</sub> = 48V, f = 1.0MHz
C <sub>oss eff.</sub>	Effective Output Capacitance	—	410	—		V <sub>GS</sub> = 0V, V <sub>DS</sub> = 0V to 48V ⑤

Symbol	Parameter	Typ.	Max.	Units
E <sub>AS</sub>	Single Pulse Avalanche Energy②	—	140	mJ
I <sub>AR</sub>	Avalanche Current①	—	4.2	A

## Diode Characteristics

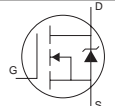
	Parameter	Min.	Typ.	Max.	Units	Conditions
I <sub>S</sub>	Continuous Source Current (Body Diode)	—	—	2.3	A	MOSFET symbol showing the integral reverse p-n junction diode. 
I <sub>SM</sub>	Pulsed Source Current (Body Diode) ①	—	—	56		
V <sub>SD</sub>	Diode Forward Voltage	—	—	1.3	V	T <sub>J</sub> = 25°C, I <sub>S</sub> = 4.2A, V <sub>GS</sub> = 0V ③
t <sub>rr</sub>	Reverse Recovery Time	—	52	78	ns	T <sub>J</sub> = 25°C, I <sub>F</sub> = 4.2A
Q <sub>rr</sub>	Reverse Recovery Charge	—	100	150	nC	di/dt = 100A/μs ③

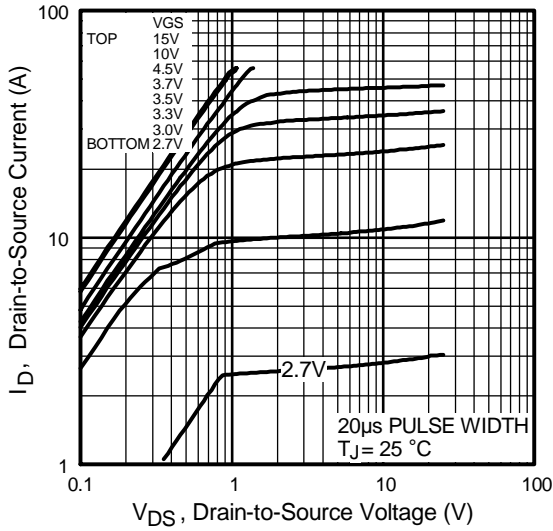

**Fig 1.** Typical Output Characteristics

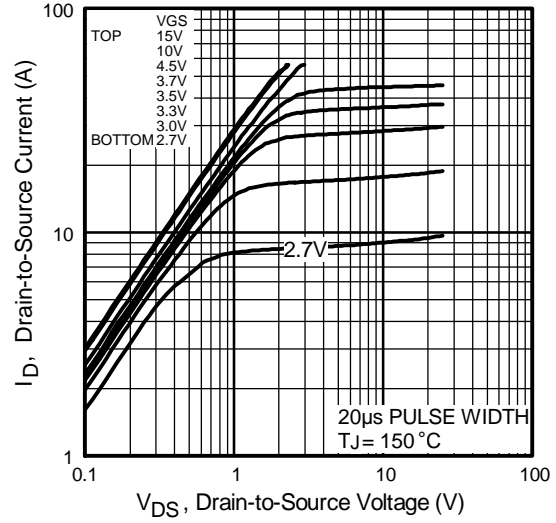

**Fig 2.** Typical Output Characteristics

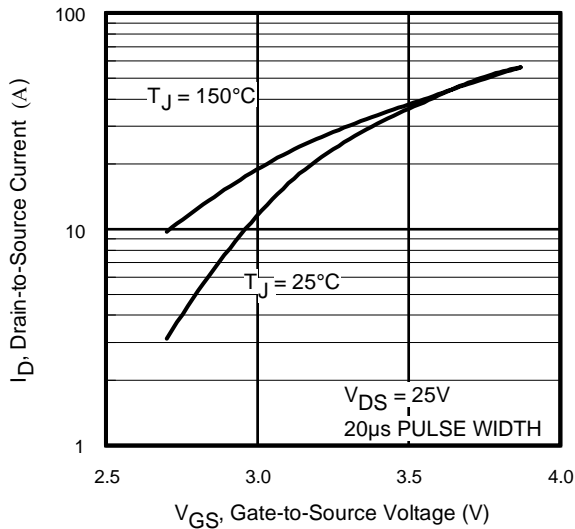

**Fig 3.** Typical Transfer Characteristics

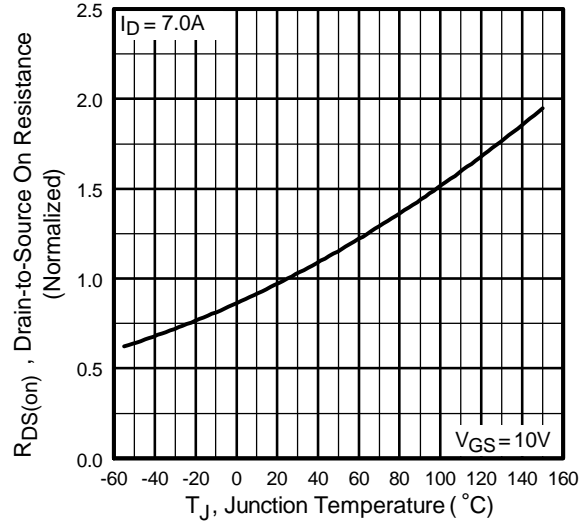

**Fig 4.** Normalized On-Resistance Vs. Temperature

# IRF7478PbF

International  
**IR** Rectifier

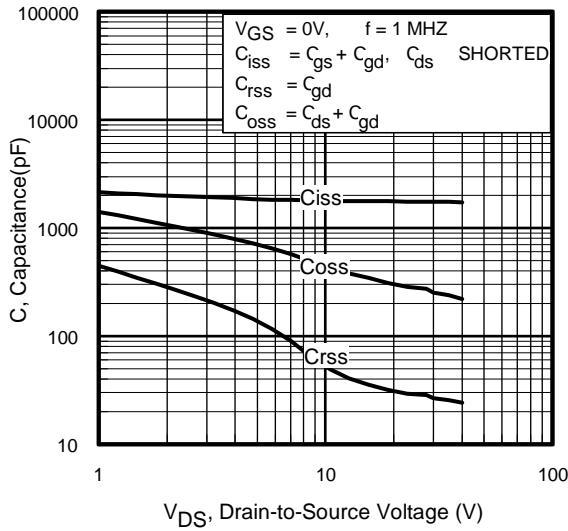

**Fig 5.** Typical Capacitance Vs. Drain-to-Source Voltage

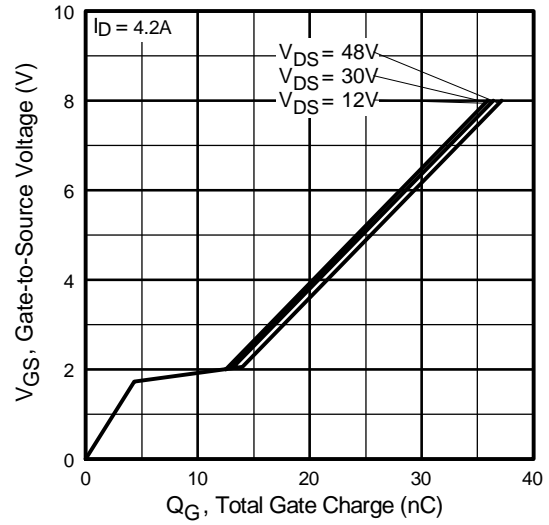

**Fig 6.** Typical Gate Charge Vs. Gate-to-Source Voltage

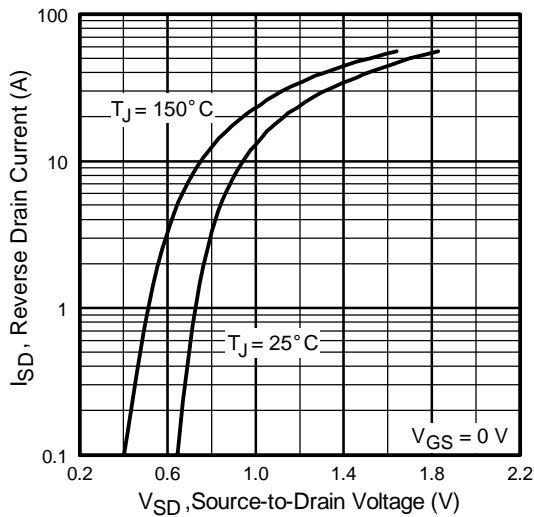

**Fig 7.** Typical Source-Drain Diode Forward Voltage

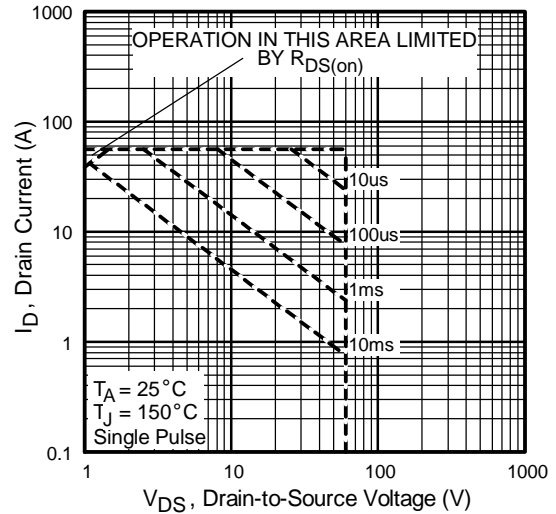

**Fig 8.** Maximum Safe Operating Area

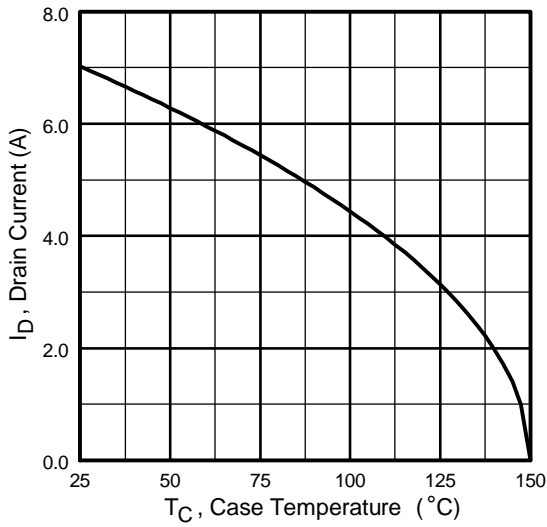

**Fig 9.** Maximum Drain Current Vs. Ambient Temperature

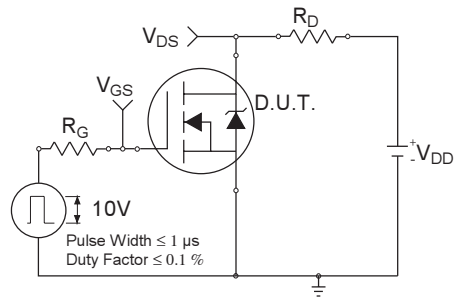

**Fig 10a.** Switching Time Test Circuit

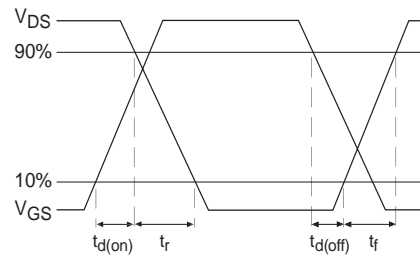

**Fig 10b.** Switching Time Waveforms

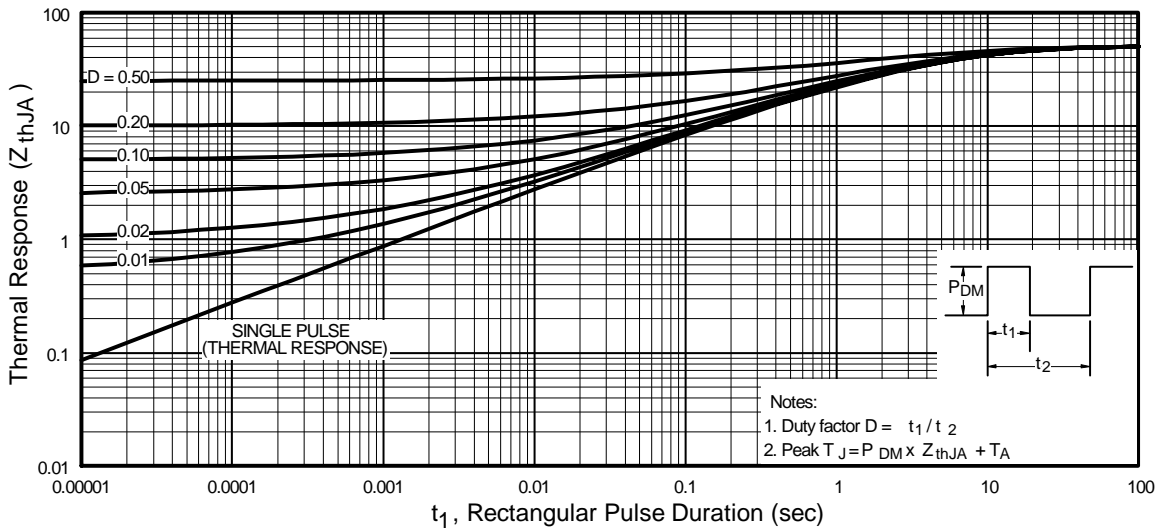

**Fig 11.** Maximum Effective Transient Thermal Impedance, Junction-to-Ambient

# IRF7478PbF

International  
**IR** Rectifier

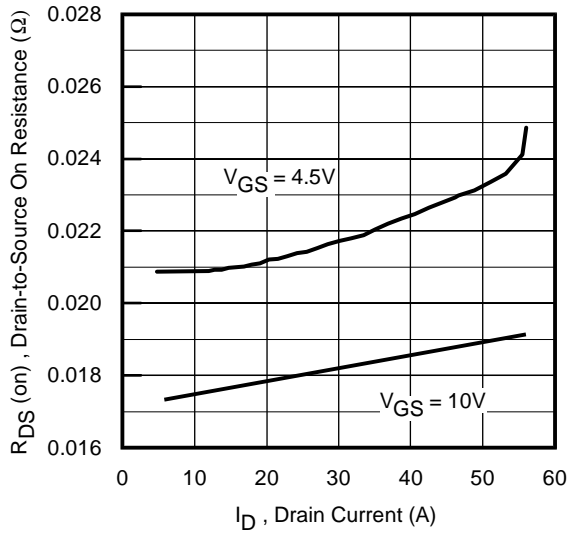

**Fig 12.** On-Resistance Vs. Drain Current

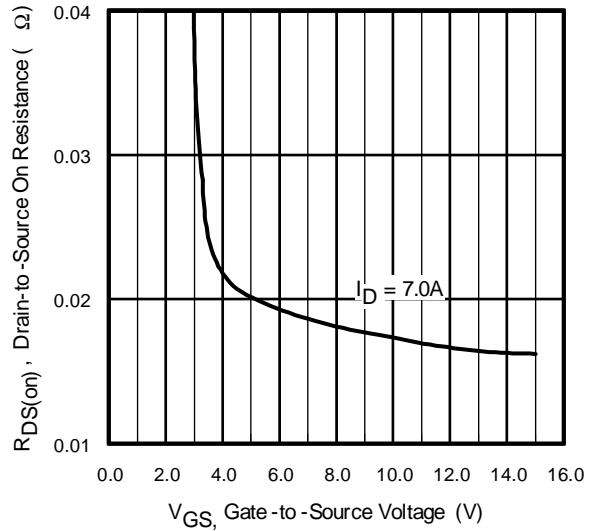

**Fig 13.** On-Resistance Vs. Gate Voltage

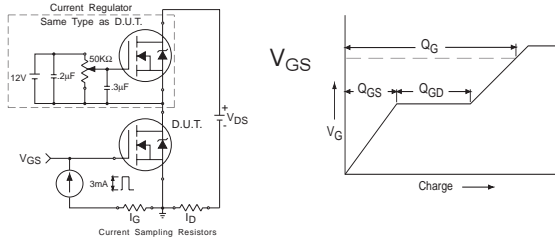

**Fig 14a&b.** Basic Gate Charge Test Circuit and Waveform

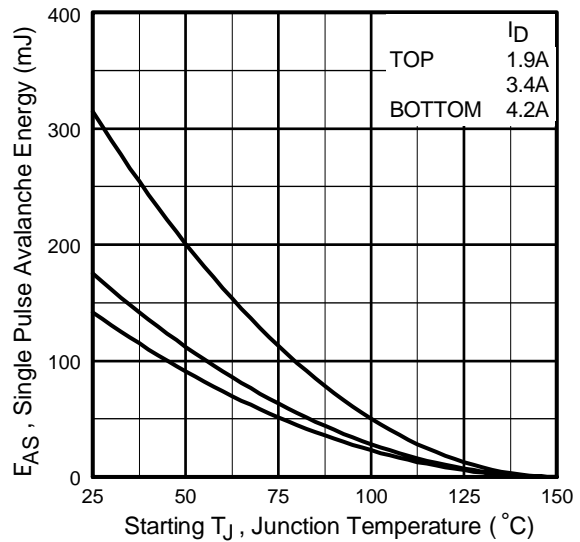

**Fig 15c.** Maximum Avalanche Energy Vs. Drain Current

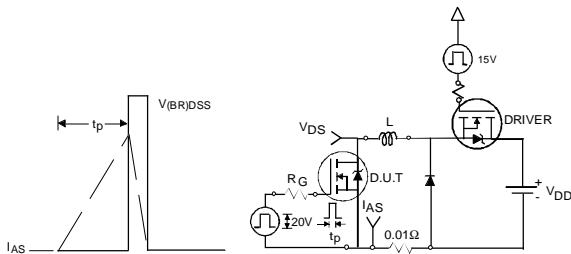

**Fig 15a&b.** Unclamped Inductive Test circuit and Waveforms

## SO-8 Package Outline

Dimensions are shown in millimeters (inches)

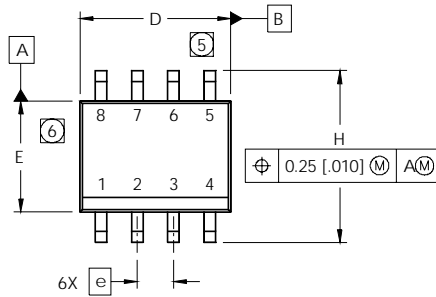

DIM	INCHES		MILLIMETERS	
	MIN	MAX	MIN	MAX
A	.0532	.0688	1.35	1.75
A1	.0040	.0098	0.10	0.25
b	.013	.020	0.33	0.51
c	.0075	.0098	0.19	0.25
D	.189	.1968	4.80	5.00
E	.1497	.1574	3.80	4.00
e	.050 BASIC		1.27 BASIC	
e1	.025 BASIC		0.635 BASIC	
H	.2284	.2440	5.80	6.20
K	.0099	.0196	0.25	0.50
L	.016	.050	0.40	1.27
y	0°	8°	0°	8°

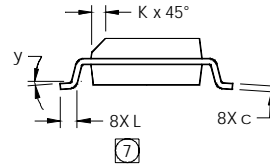
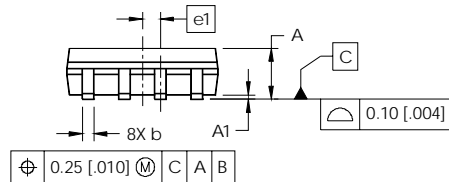

**NOTES:**

1. DIMENSIONING & TOLERANCING PER ASME Y14.5M-1994.
2. CONTROLLING DIMENSION: MILLIMETER
3. DIMENSIONS ARE SHOWN IN MILLIMETERS [INCHES].
4. OUTLINE CONFORMS TO JEDEC OUTLINE MS-012AA.
- ⑤ DIMENSION DOES NOT INCLUDE MOLD PROTRUSIONS. MOLD PROTRUSIONS NOT TO EXCEED 0.15 [0.006].
- ⑥ DIMENSION DOES NOT INCLUDE MOLD PROTRUSIONS. MOLD PROTRUSIONS NOT TO EXCEED 0.25 [0.010].
- ⑦ DIMENSION IS THE LENGTH OF LEAD FOR SOLDERING TO A SUBSTRATE.

**FOOTPRINT**

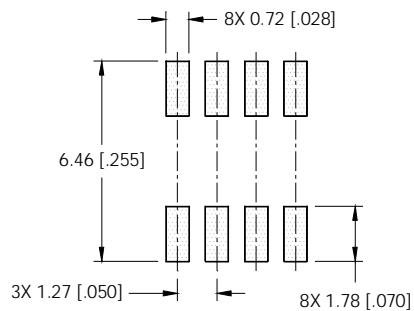

## SO-8 Part Marking

EXAMPLE: THIS IS AN IRF7101 (MOSFET)

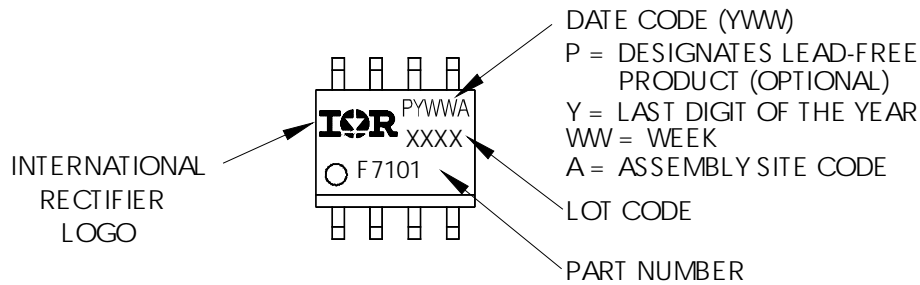

# IRF7478PbF

## SO-8 Tape and Reel

Dimensions are shown in millimeters (inches)

International  
**IR** Rectifier

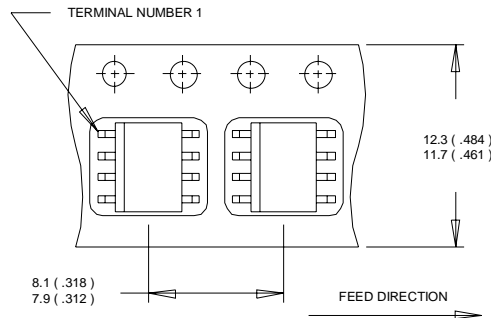

- NOTES:
1. CONTROLLING DIMENSION : MILLIMETER.
  2. ALL DIMENSIONS ARE SHOWN IN MILLIMETERS(INCHES).
  3. OUTLINE CONFORMS TO EIA-481 & EIA-541.

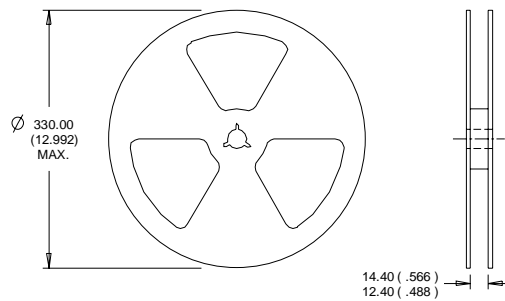

- NOTES:
1. CONTROLLING DIMENSION : MILLIMETER.
  2. OUTLINE CONFORMS TO EIA-481 & EIA-541.

### Notes:

- ① Repetitive rating; pulse width limited by max. junction temperature.
- ② Starting  $T_J = 25^\circ\text{C}$ ,  $L = 16\text{mH}$   
 $R_G = 25\Omega$ ,  $I_{AS} = 4.2\text{A}$ .
- ③ Pulse width  $\leq 400\mu\text{s}$ ; duty cycle  $\leq 2\%$ .
- ④ When mounted on 1 inch square copper board
- ⑤  $C_{OSS}$  eff. is a fixed capacitance that gives the same charging time as  $C_{OSS}$  while  $V_{DS}$  is rising from 0 to 80%  $V_{DSS}$
- ⑥  $I_{SD} \leq 4.2\text{A}$ ,  $di/dt \leq 160\text{A}/\mu\text{s}$ ,  $V_{DD} \leq V_{(BR)DSS}$ ,  
 $T_J \leq 150^\circ\text{C}$

Data and specifications subject to change without notice.  
This product has been designed and qualified for the Consumer market.  
Qualifications Standards can be found on IR's Web site.

International  
**IR** Rectifier

IR WORLD HEADQUARTERS: 233 Kansas St., El Segundo, California 90245, USA Tel: (310) 252-7105  
TAC Fax: (310) 252-7903

Visit us at [www.irf.com](http://www.irf.com) for sales contact information.09/04

[www.irf.com](http://www.irf.com)



# Mouser Electronics

Authorized Distributor

Click to View Pricing, Inventory, Delivery & Lifecycle Information:

[Infineon:](#)

[IRF7478PBF](#) [IRF7478TRPBF](#)