

TLV2371-EP, TLV2372-EP, TLV2374-EP FAMILY OF 550- μ A/Ch 3-MHz RAIL-TO-RAIL INPUT/OUTPUT OPERATIONAL AMPLIFIERS

SGLS306A – APRIL 2005 – REVISED APRIL 2006

- **Controlled Baseline**
 - One Assembly/Test Site, One Fabrication Site
- **Extended Temperature Performance of -55°C to 125°C**
- **Enhanced Diminishing Manufacturing Sources (DMS) Support**
- **Enhanced Product-Change Notification**
- **Qualification Pedigree†**
- **Rail-To-Rail Input/Output**
- **Wide Bandwidth . . . 3 MHz**
- **High Slew Rate . . . 2.4 V/ μ s**
- **Supply Voltage Range . . . 2.7 V to 16 V**
- **Supply Current . . . 550 μ A/Channel**
- **Input Noise Voltage . . . 39 nV/ $\sqrt{\text{Hz}}$**
- **Input Bias Current . . . 1 pA**
- **Specified Temperature Range -55°C to 125°C**
- **Ultrasmall Packaging**
 - 5-Pin SOT-23 (TLV2371)
 - 8-Pin MSOP (TLV2372)

† Component qualification in accordance with JEDEC and industry standards to ensure reliable operation over an extended temperature range. This includes, but is not limited to, Highly Accelerated Stress Test (HAST) or biased 85/85, temperature cycle, autoclave or unbiased HAST, electromigration, bond intermetallic life, and mold compound life. Such qualification testing should not be viewed as justifying use of this component beyond specified performance and environmental limits.

Operational Amplifier

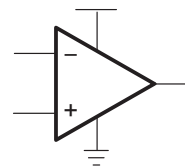

description

The TLV237x single supply operational amplifiers provide rail-to-rail input and output capability. The TLV237x takes the minimum operating supply voltage down to 2.7 V over the extended automotive temperature range while adding the rail-to-rail output swing feature. The TLV237x also provides 3-MHz bandwidth from only 550 μ A. The maximum recommended supply voltage is 16 V, which allows the devices to be operated from (± 8 V supplies down to ± 1.35 V) a variety of rechargeable cells.

The CMOS inputs enable use in high-impedance sensor interfaces, with the lower voltage operation making an ideal alternative for the TLC227x in battery-powered applications. The rail-to-rail input stage further increases its versatility. The TLV237x is the seventh member of a rapidly growing number of RRIO products available from Texas Instruments and it is the first to allow operation up to 16-V rails with good ac performance.

The 2.7-V operation makes the TLV237x compatible with Li-Ion powered systems and the operating supply voltage range of many micro-power microcontrollers available today including Texas Instruments' MSP430.

SELECTION OF SIGNAL AMPLIFIER PRODUCTST

DEVICE	V _{DD} (V)	V _{IO} (μ V)	I _q /Ch (μ A)	I _{IB} (pA)	GBW (MHz)	SR (V/ μ s)	SHUTDOWN	RAIL-TO-RAIL	SINGLES/DUALS/QUADS
TLV237x	2.7–16	500	550	1	3	2.4	Yes	I/O	S/D/Q
TLC227x	4–16	300	1100	1	2.2	3.6	—	O	D/Q
TLV27x	2.7–16	500	550	1	3	2.4	—	O	S/D/Q
TLC27x	3–16	1100	675	1	1.7	3.6	—	—	S/D/Q
TLV246x	2.7–6	150	550	1300	6.4	1.6	Yes	I/O	S/D/Q
TLV247x	2.7–6	250	600	2	2.8	1.5	Yes	I/O	S/D/Q
TLV244x	2.7–10	300	725	1	1.8	1.4	—	O	D/Q

† Typical values measured at 5 V, 25°C



Please be aware that an important notice concerning availability, standard warranty, and use in critical applications of Texas Instruments semiconductor products and disclaimers thereto appears at the end of this data sheet.

PRODUCTION DATA information is current as of publication date. Products conform to specifications per the terms of Texas Instruments standard warranty. Production processing does not necessarily include testing of all parameters.

**TEXAS
INSTRUMENTS**

POST OFFICE BOX 655303 • DALLAS, TEXAS 75265
POST OFFICE BOX 1443 • HOUSTON, TEXAS 77251-1443

Copyright © 2006, Texas Instruments Incorporated

TLV2371-EP, TLV2372-EP, TLV2374-EP FAMILY OF 550- μ A/Ch 3-MHz RAIL-TO-RAIL INPUT/OUTPUT OPERATIONAL AMPLIFIERS

SGLS306A – APRIL 2005 – REVISED APRIL 2006

FAMILY PACKAGE TABLE

DEVICE	NUMBER OF CHANNELS	PACKAGE TYPES				UNIVERSAL EVM BOARD
		SOIC	SOT-23	TSSOP	MSOP	
TLV2371	1	8	5	—	—	See the EVM Selection Guide (SLOU060)
TLV2372	2	8	—	—	8	
TLV2374	4	14	—	14	—	

TLV2371 AVAILABLE OPTIONS

T_A	$V_{IO\text{MAX}}$ AT 25°C	PACKAGED DEVICES		
		SMALL OUTLINE (D)	SOT-23	
			(DBV)	SYMBOL
-55°C to 125°C	4.5 mV	TLV2371MDREP†	TLV2371MDBVREP	371E

TLV2372 AVAILABLE OPTIONS

T_A	$V_{IO\text{MAX}}$ AT 25°C	PACKAGED DEVICES		
		SMALL OUTLINE (D)	MSOP	
			(DGK)	SYMBOL
-55°C to 125°C	4.5 mV	TLV2372MDREP†	TLV2372MDGKREP†	

† Product Preview

TLV2374 AVAILABLE OPTIONS

T_A	$V_{IO\text{MAX}}$ AT 25°C	PACKAGED DEVICES	
		SMALL OUTLINE (D)	TSSOP (PW)
-55°C to 125°C	4.5 mV	TLV2374MDREP	TLV2374MPWREP†

† Product Preview

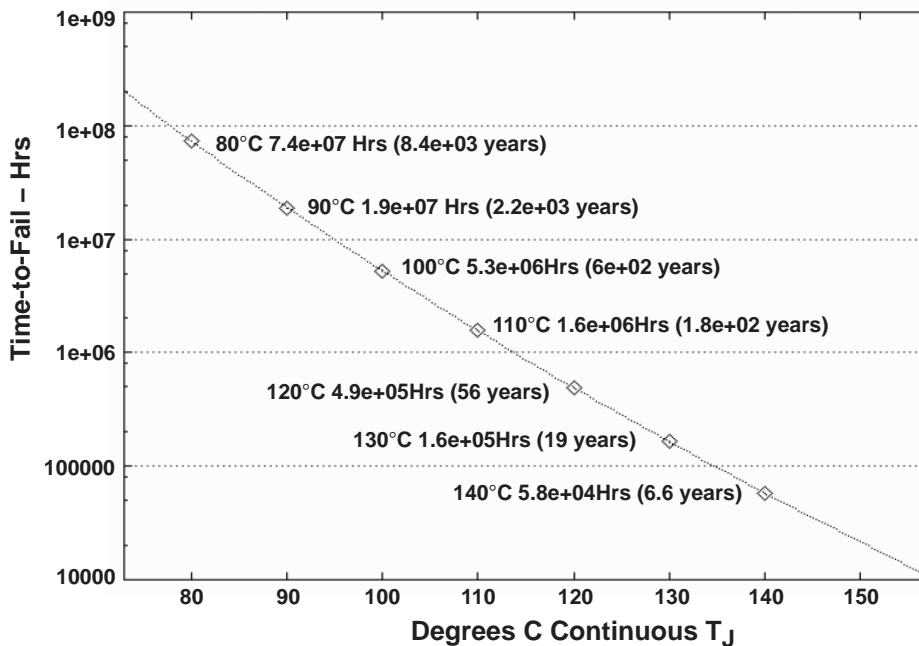

Figure 1. Wirebond Life Plot



TLV2371-EP, TLV2372-EP, TLV2374-EP FAMILY OF 550- μ A/Ch 3-MHz RAIL-TO-RAIL INPUT/OUTPUT OPERATIONAL AMPLIFIERS

SGLS306A – APRIL 2005 – REVISED APRIL 2006

TLV237x PACKAGE PINOUTS(1)

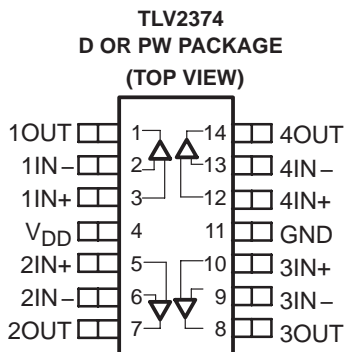
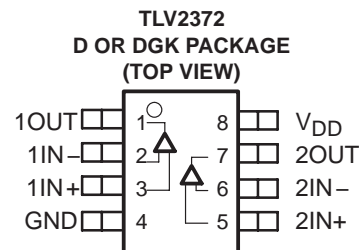
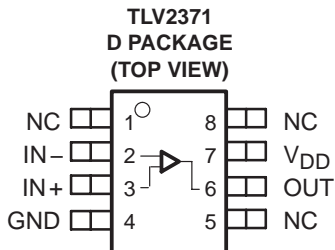
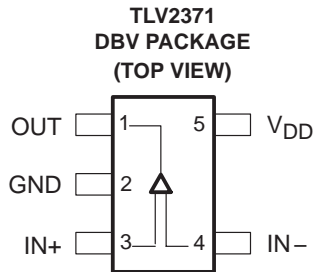

NC – No internal connection

(1) SOT-23 may or may not be indicated

TYPICAL PIN 1 INDICATORS

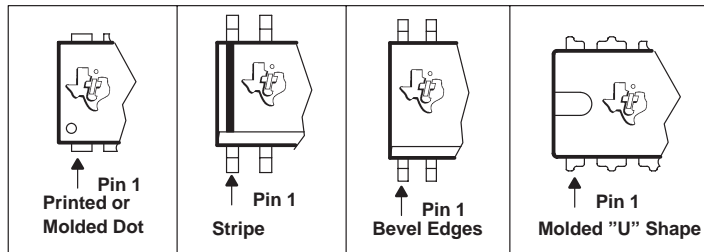

TLV2371-EP, TLV2372-EP, TLV2374-EP
FAMILY OF 550- μ A/Ch 3-MHz RAIL-TO-RAIL INPUT/OUTPUT
OPERATIONAL AMPLIFIERS

SGLS306A – APRIL 2005 – REVISED APRIL 2006

absolute maximum ratings over operating free-air temperature range (unless otherwise noted)†

Supply voltage, V_{DD} (see Note 1)	16.5 V
Differential input voltage, V_{ID}	$\pm V_{DD}$
Input voltage range, V_I (see Note 1)	-0.2 V to $V_{DD} + 0.2$ V
Input current range, I_I	± 10 mA
Output current range, I_O	± 100 mA
Package thermal impedance, θ_{JA} (see Notes 2 and 3):	
D (8-pin) package	176°C/W
D (14-pin) package	122.3°C/W
D (16-pin) package	114.7°C/W
DBV (5-pin) package	324.1°C/W
DGK (8-pin) package	259.96°C/W
PW (14-pin) package	173.6°C/W
Operating free-air temperature range, T_A	-55°C to 125°C
Maximum junction temperature, T_J	150°C
Storage temperature range, T_{stg}	-65°C to 150°C
Lead temperature 1,6 mm (1/16 inch) from case for 10 seconds	260°C

† Stresses beyond those listed under “absolute maximum ratings” may cause permanent damage to the device. These are stress ratings only, and functional operation of the device at these or any other conditions beyond those indicated under “recommended operating conditions” is not implied. Exposure to absolute-maximum-rated conditions for extended periods may affect device reliability.

- NOTES: 1. All voltage values, except differential voltages, are with respect to GND.
 2. Maximum power dissipation is a function of $T_{J(max)}$, θ_{JA} , and T_A . The maximum allowable power dissipation at any allowable ambient temperature is $P_D = (T_{J(max)} - T_A)/\theta_{JA}$. Selecting the maximum of 150°C can affect reliability.
 3. The package thermal impedance is calculated in accordance with JESD 51-7.

recommended operating conditions

		MIN	MAX	UNIT
Supply voltage, V_{DD}	Single supply	2.7	16	V
	Split supply	± 1.35	± 8	
Common-mode input voltage range, V_{ICR}		0	V_{DD}	V
Turnon voltage level, $V_{(ON)}$, relative to GND pin voltage			2	V
Turnoff voltage level, $V_{(OFF)}$, relative to GND pin voltage		0.8		V
Operating free-air temperature, T_A	M-suffix	-55	125	°C



TLV2371-EP, TLV2372-EP, TLV2374-EP
FAMILY OF 550- μ A/Ch 3-MHz RAIL-TO-RAIL INPUT/OUTPUT
OPERATIONAL AMPLIFIERS

SGLS306A – APRIL 2005 – REVISED APRIL 2006

electrical characteristics at specified free-air temperature, $V_{DD} = 2.7\text{ V}$, 5 V , and 15 V (unless otherwise noted)

dc performance

PARAMETER		TEST CONDITIONS		T_A	MIN	TYP	MAX	UNIT
V_{IO}	Input offset voltage	$V_{IC} = V_{DD}/2,$ $R_S = 50\ \Omega$	$V_O = V_{DD}/2,$	25°C		2	4.5	mV
				Full range			6	
α_{VIO}	Offset voltage drift			25°C		2		$\mu\text{V}/^\circ\text{C}$
CMRR	Common-mode rejection ratio	$V_{IC} = 0\text{ to }V_{DD},$ $R_S = 50\ \Omega$	$V_{DD} = 2.7\text{ V}$	25°C	50	68	dB	
				Full range	47			
				25°C	53	70		
				Full range	50			
				25°C	55	72		
				Full range	54			
		$V_{IC} = 0\text{ to }V_{DD}-1.35\text{ V},$ $R_S = 50\ \Omega,$	$V_{DD} = 5\text{ V}$	25°C	58	80		
				Full range	54			
				25°C	64	82		
				Full range	63			
				25°C	67	84		
				Full range	66			
$V_{IC} = 0\text{ to }V_{DD},$ $R_S = 50\ \Omega,$	$V_{DD} = 15\text{ V}$	25°C	95	106				
		Full range	60					
		25°C	80	110				
		Full range	78					
		25°C	77	83				
		Full range	73					
A_{VD}	Large-signal differential voltage amplification	$V_{O(PP)} = V_{DD}/2,$ $R_L = 10\text{ k}\Omega$	$V_{DD} = 2.7\text{ V}$	25°C	95	106	dB	
				Full range	60			
				25°C	80	110		
				Full range	78			
				25°C	77	83		
				Full range	73			

input characteristics

PARAMETER		TEST CONDITIONS		T_A	MIN	TYP	MAX	UNIT
I_{IO}	Input offset current	$V_{DD} = 15\text{ V},$ $V_O = V_{DD}/2$	$V_{IC} = V_{DD}/2,$	25°C		1	60	pA
				125°C			1000	
I_{IB}	Input bias current	$V_{DD} = 15\text{ V},$ $V_O = V_{DD}/2$	$V_{IC} = V_{DD}/2,$	25°C		1	60	pA
				125°C			1000	
$r_{i(d)}$	Differential input resistance			25°C		1000		G Ω
C_{IC}	Common-mode input capacitance		$f = 21\text{ kHz}$	25°C		8		pF



TLV2371-EP, TLV2372-EP, TLV2374-EP
FAMILY OF 550- μ A/Ch 3-MHz RAIL-TO-RAIL INPUT/OUTPUT
OPERATIONAL AMPLIFIERS

SGLS306A – APRIL 2005 – REVISED APRIL 2006

electrical characteristics at specified free-air temperature, $V_{DD} = 2.7\text{ V}$, 5 V , and 15 V (unless otherwise noted) (continued)

output characteristics

PARAMETER	TEST CONDITIONS	T_A	MIN	TYP	MAX	UNIT
V_{OH} High-level output voltage	$V_{IC} = V_{DD}/2, I_{OH} = -1\text{ mA}$	$V_{DD} = 2.7\text{ V}$	25°C	2.55	2.58	V
			Full range	2.48		
		$V_{DD} = 5\text{ V}$	25°C	4.9	4.93	
			Full range	4.85		
		$V_{DD} = 15\text{ V}$	25°C	14.92	14.96	
			Full range	14.9		
	$V_{IC} = V_{DD}/2, I_{OH} = -5\text{ mA}$	$V_{DD} = 2.7\text{ V}$	25°C	1.88	2	
			Full range	1.42		
		$V_{DD} = 5\text{ V}$	25°C	4.58	4.68	
			Full range	4.44		
		$V_{DD} = 15\text{ V}$	25°C	14.7	14.8	
			Full range	14.6		
V_{OL} Low-level output voltage	$V_{IC} = V_{DD}/2, I_{OL} = 1\text{ mA}$	$V_{DD} = 2.7\text{ V}$	25°C	0.1	0.15	V
			Full range		0.22	
		$V_{DD} = 5\text{ V}$	25°C	0.05	0.1	
			Full range		0.15	
		$V_{DD} = 15\text{ V}$	25°C	0.05	0.08	
			Full range		0.1	
	$V_{IC} = V_{DD}/2, I_{OL} = 5\text{ mA}$	$V_{DD} = 2.7\text{ V}$	25°C	0.52	0.7	
			Full range		1.15	
		$V_{DD} = 5\text{ V}$	25°C	0.28	0.4	
			Full range		0.54	
		$V_{DD} = 15\text{ V}$	25°C	0.19	0.3	
			Full range		0.35	

power supply

PARAMETER	TEST CONDITIONS	T_A	MIN	TYP	MAX	UNIT
I_{DD} Supply current (per channel)	$V_O = V_{DD}/2,$	$V_{DD} = 2.7\text{ V}$	25°C	470	560	μA
		$V_{DD} = 5\text{ V}$	25°C	550	660	
		$V_{DD} = 15\text{ V}$	25°C	750	900	
			Full range		1200	
PSRR Supply voltage rejection ratio ($\Delta V_{DD} / \Delta V_{IO}$)	$V_{DD} = 2.7\text{ V}$ to 15 V , No load	$V_{IC} = V_{DD}/2,$	25°C	70	80	dB
			Full range	65		



TLV2371-EP, TLV2372-EP, TLV2374-EP
FAMILY OF 550- μ A/Ch 3-MHz RAIL-TO-RAIL INPUT/OUTPUT
OPERATIONAL AMPLIFIERS

SGLS306A – APRIL 2005 – REVISED APRIL 2006

electrical characteristics at specified free-air temperature, $V_{DD} = 2.7\text{ V}$, 5 V , and 15 V (unless otherwise noted) (continued)

dynamic performance

PARAMETER		TEST CONDITIONS		T_A	MIN	TYP	MAX	UNIT
UGBW	Unity gain bandwidth	$R_L = 2\text{ k}\Omega$, $C_L = 10\text{ pF}$	$V_{DD} = 2.7\text{ V}$	25°C	2.4		3	MHz
			$V_{DD} = 5\text{ V to }15\text{ V}$	25°C				
SR	Slew rate at unity gain	$V_{O(PP)} = V_{DD}/2$, $C_L = 50\text{ pF}$, $R_L = 10\text{ k}\Omega$	$V_{DD} = 2.7\text{ V}$	25°C	1.4	2	1	V/ μ s
				Full range				
			$V_{DD} = 5\text{ V}$	25°C	1.4	2.4	1.1	V/ μ s
				Full range				
			$V_{DD} = 15\text{ V}$	25°C	1.9	2.1	1.2	V/ μ s
				Full range				
ϕ_m	Phase margin	$R_L = 2\text{ k}\Omega$,	$C_L = 100\text{ pF}$	25°C	65°			
	Gain margin	$R_L = 2\text{ k}\Omega$,	$C_L = 10\text{ pF}$	25°C	18		dB	
t_s	Settling time	$V_{DD} = 2.7\text{ V}$, $V_{(STEP)PP} = 1\text{ V}$, $A_V = -1$, $C_L = 10\text{ pF}$, $R_L = 2\text{ k}\Omega$	0.1%	25°C	2.9		μ s	
			$V_{DD} = 5\text{ V, }15\text{ V}$, $V_{(STEP)PP} = 1\text{ V}$, $A_V = -1$, $C_L = 47\text{ pF}$, $R_L = 2\text{ k}\Omega$		0.1%	2		

noise/distortion performance

PARAMETER		TEST CONDITIONS		T_A	MIN	TYP	MAX	UNIT
THD + N	Total harmonic distortion plus noise	$V_{DD} = 2.7\text{ V}$, $V_{O(PP)} = V_{DD}/2\text{ V}$, $R_L = 2\text{ k}\Omega$, $f = 10\text{ kHz}$	$A_V = 1$	25°C	0.02%			
			$A_V = 10$		0.05%			
			$A_V = 100$		0.18%			
			$V_{DD} = 5\text{ V, }5\text{ V}$, $V_{O(PP)} = V_{DD}/2\text{ V}$, $R_L = 2\text{ k}\Omega$, $f = 10\text{ kHz}$	$A_V = 1$	25°C	0.02%		
				$A_V = 10$		0.09%		
				$A_V = 100$		0.5%		
V_n	Equivalent input noise voltage	$f = 1\text{ kHz}$	25°C	39		nV/ $\sqrt{\text{Hz}}$		
		$f = 10\text{ kHz}$		35				
I_n	Equivalent input noise current	$f = 1\text{ kHz}$	25°C	0.6		fA/ $\sqrt{\text{Hz}}$		



TLV2371-EP, TLV2372-EP, TLV2374-EP
FAMILY OF 550- μ A/Ch 3-MHz RAIL-TO-RAIL INPUT/OUTPUT
OPERATIONAL AMPLIFIERS

SGLS306A – APRIL 2005 – REVISED APRIL 2006

TYPICAL CHARACTERISTICS

Table of Graphs

			FIGURE
V_{IO}	Input offset voltage	vs Common-mode input voltage	1, 2, 3
CMRR	Common-mode rejection ratio	vs Frequency	4
	Input bias and offset current	vs Free-air temperature	5
V_{OL}	Low-level output voltage	vs Low-level output current	6, 8, 10
V_{OH}	High-level output voltage	vs High-level output current	7, 9, 11
$V_{O(PP)}$	Peak-to-peak output voltage	vs Frequency	12
I_{DD}	Supply current	vs Supply voltage	13
PSRR	Power supply rejection ratio	vs Frequency	14
A_{VD}	Differential voltage gain & phase	vs Frequency	15
	Gain-bandwidth product	vs Free-air temperature	16
SR	Slew rate	vs Supply voltage	17
		vs Free-air temperature	18
ϕ_m	Phase margin	vs Capacitive load	19
V_n	Equivalent input noise voltage	vs Frequency	20
	Voltage-follower large-signal pulse response		21, 22
	Voltage-follower small-signal pulse response		23
	Inverting large-signal response		24, 25
	Inverting small-signal response		26
	Crosstalk	vs Frequency	27



TLV2371-EP, TLV2372-EP, TLV2374-EP FAMILY OF 550- μ A/Ch 3-MHz RAIL-TO-RAIL INPUT/OUTPUT OPERATIONAL AMPLIFIERS

SGLS306A – APRIL 2005 – REVISED APRIL 2006

TYPICAL CHARACTERISTICS

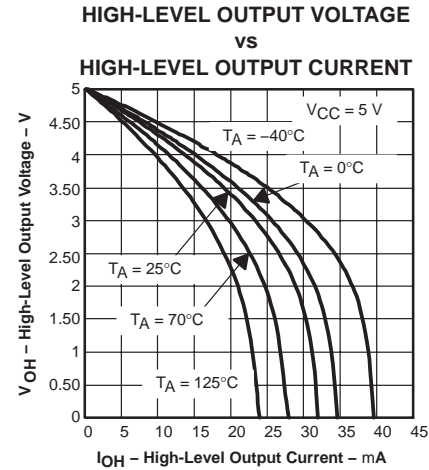
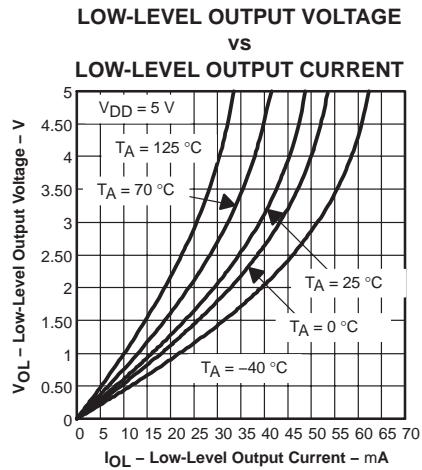
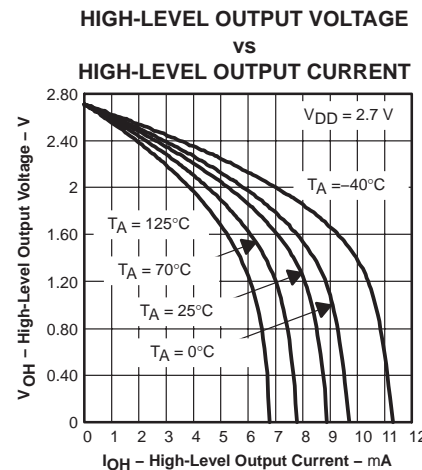
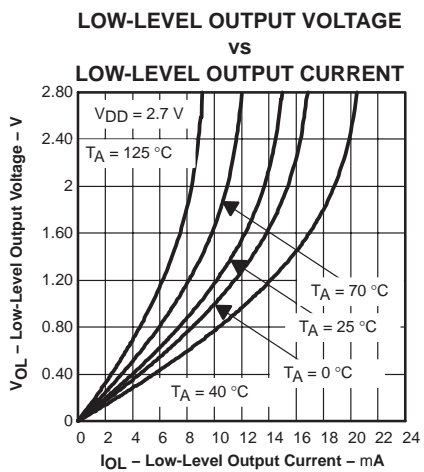
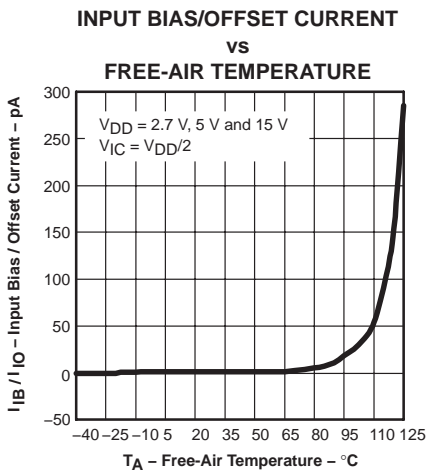
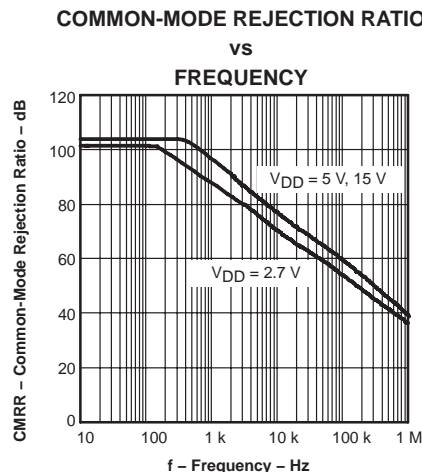
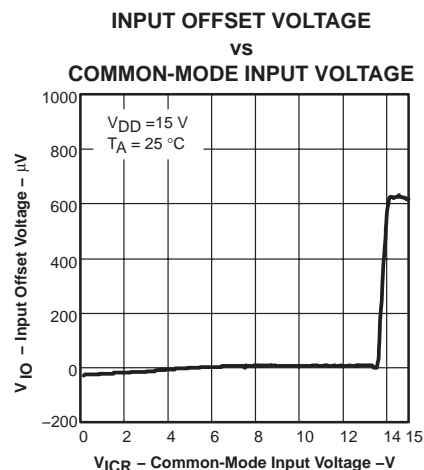
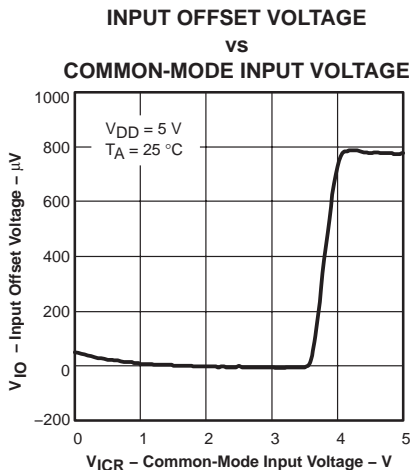
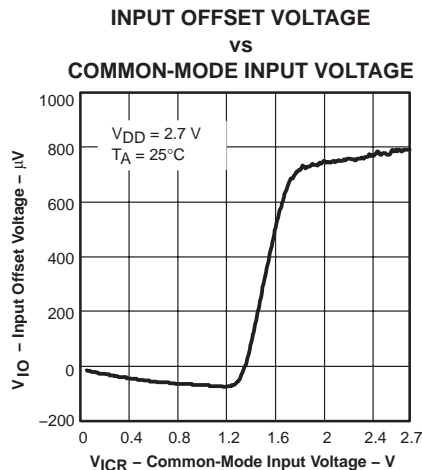

TLV2371-EP, TLV2372-EP, TLV2374-EP FAMILY OF 550- μ A/Ch 3-MHz RAIL-TO-RAIL INPUT/OUTPUT OPERATIONAL AMPLIFIERS

SGLS306A – APRIL 2005 – REVISED APRIL 2006

TYPICAL CHARACTERISTICS

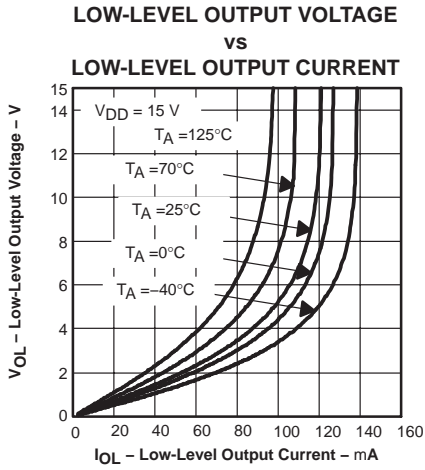

Figure 11

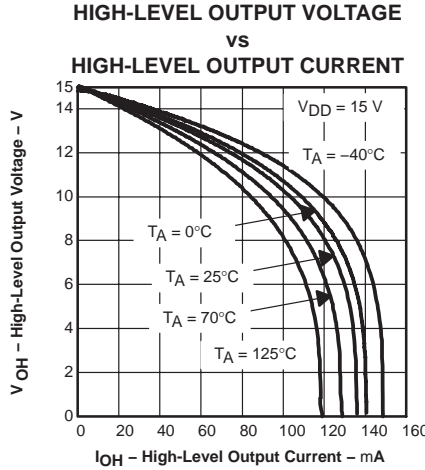

Figure 12

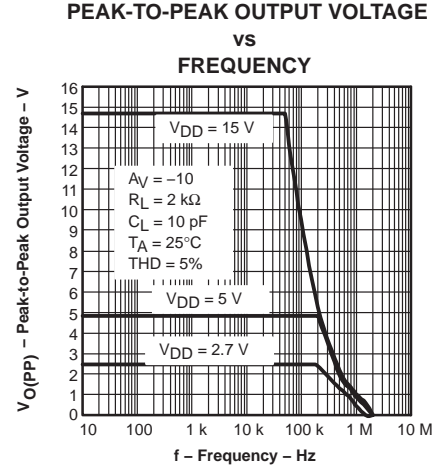

Figure 13

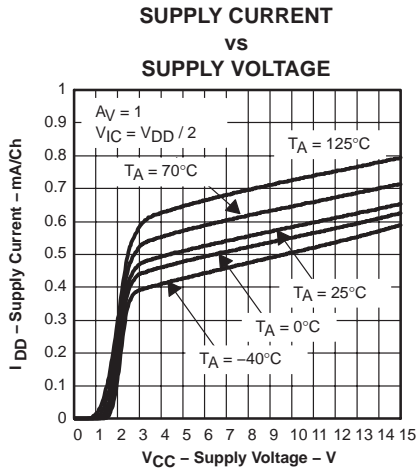

Figure 14

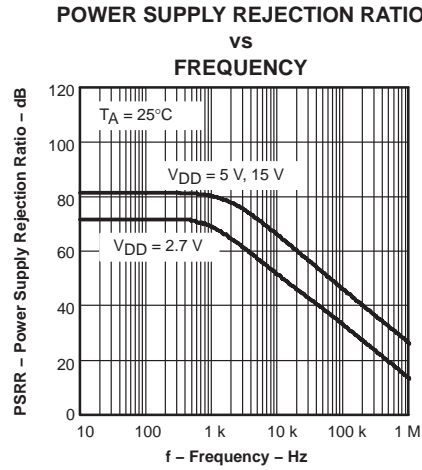

Figure 15

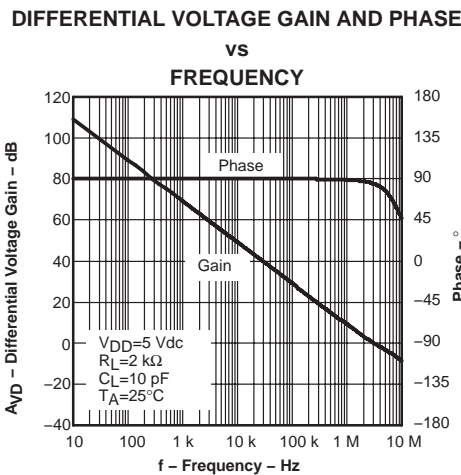

Figure 16

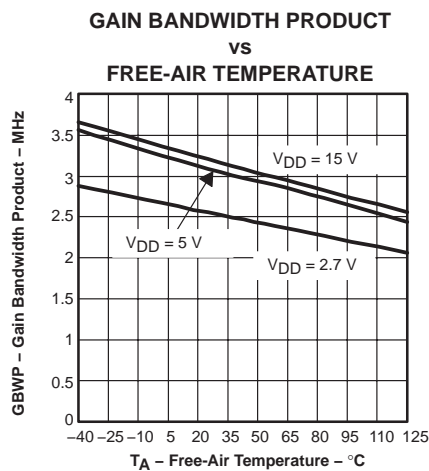

Figure 17

TLV2371-EP, TLV2372-EP, TLV2374-EP FAMILY OF 550- μ A/Ch 3-MHz RAIL-TO-RAIL INPUT/OUTPUT OPERATIONAL AMPLIFIERS

SGLS306A – APRIL 2005 – REVISED APRIL 2006

TYPICAL CHARACTERISTICS

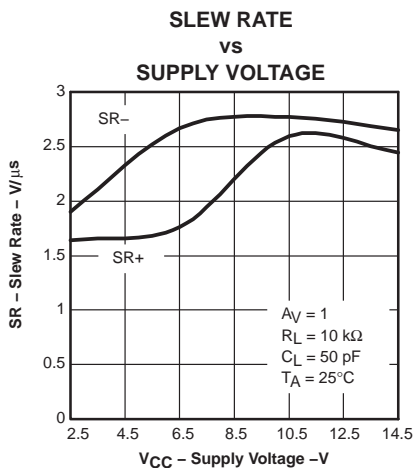

Figure 18

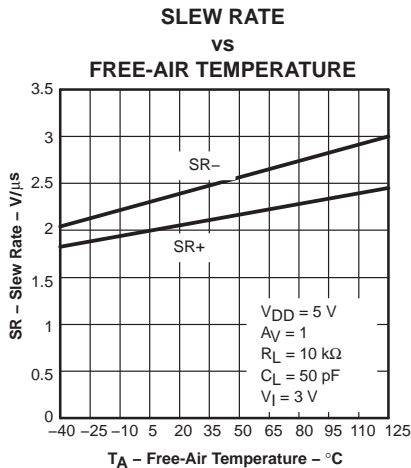

Figure 19

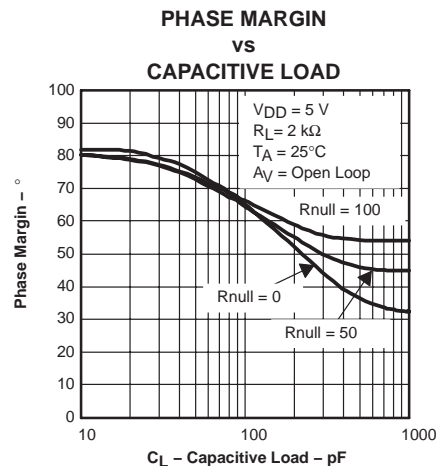

Figure 20

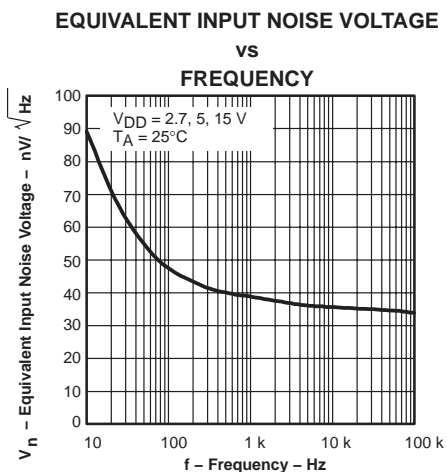

Figure 21

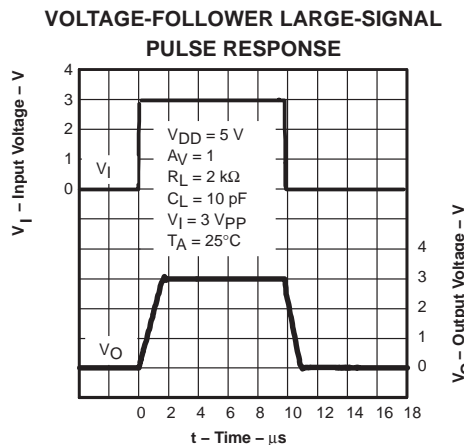

Figure 22

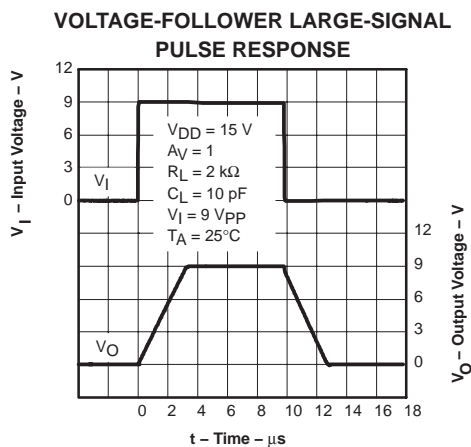

Figure 23

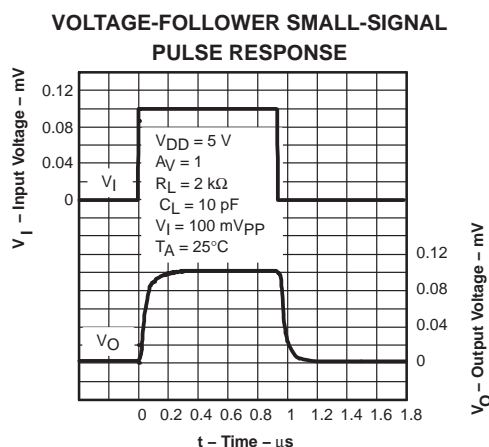

Figure 24



TLV2371-EP, TLV2372-EP, TLV2374-EP FAMILY OF 550- μ A/Ch 3-MHz RAIL-TO-RAIL INPUT/OUTPUT OPERATIONAL AMPLIFIERS

SGLS306A – APRIL 2005 – REVISED APRIL 2006

TYPICAL CHARACTERISTICS

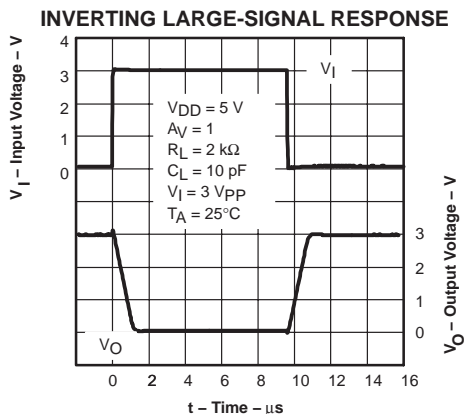

Figure 25

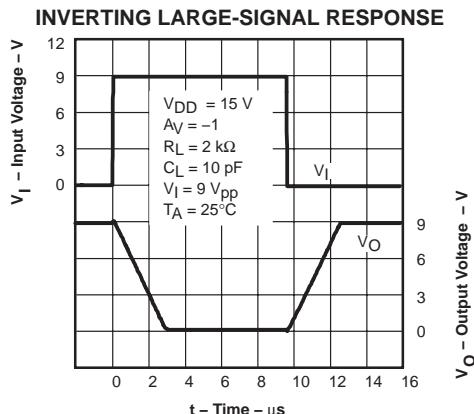

Figure 26

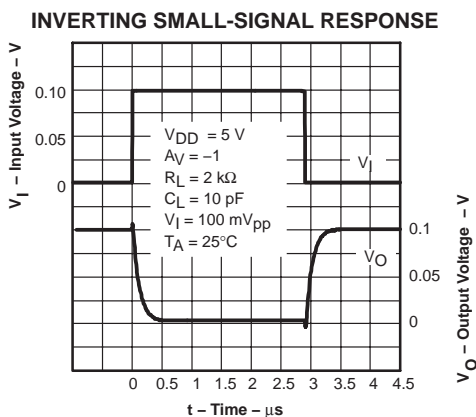

Figure 27

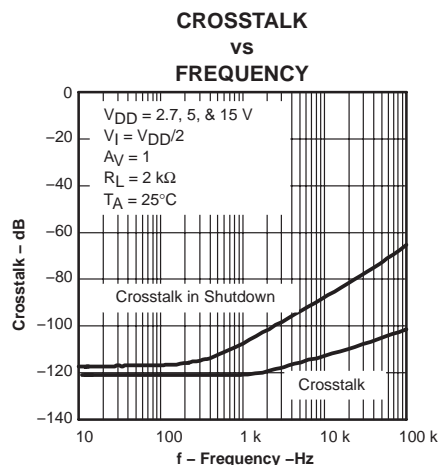

Figure 28

APPLICATION INFORMATION

rail-to-rail input operation

The TLV237x input stage consists of two differential transistor pairs, NMOS and PMOS, that operate together to achieve rail-to-rail input operation. The transition point between these two pairs can be seen in Figure 2 through Figure 4 for a 2.7-V, 5-V, and 15-V supply. As the common-mode input voltage approaches the positive supply rail, the input pair switches from the PMOS differential pair to the NMOS differential pair. This transition occurs approximately 1.35 V from the positive rail and results in a change in offset voltage due to different device characteristics between the NMOS and PMOS pairs. If the input signal to the device is large enough to swing between both rails, this transition results in a reduction in common-mode rejection ratio (CMRR). If the input signal does not swing between both rails, it is best to bias the signal in the region where only one input pair is active. This is the region in Figure 2 through Figure 4 where the offset voltage varies slightly across the input range and optimal CMRR can be achieved. This has the greatest impact when operating from a 2.7-V supply voltage.

driving a capacitive load

When the amplifier is configured in this manner, capacitive loading directly on the output decreases the device's phase margin, leading to high frequency ringing or oscillations. Therefore, for capacitive loads of greater than 10 pF, it is recommended that a resistor be placed in series (R_{NULL}) with the output of the amplifier, as shown in Figure 29. A minimum value of 20 Ω should work well for most applications.

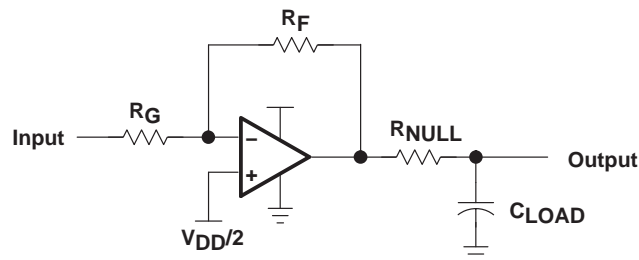

Figure 29. Driving a Capacitive Load

offset voltage

The output offset voltage, (V_{OO}) is the sum of the input offset voltage (V_{IO}) and both input bias currents (I_{IB}) times the corresponding gains. The schematic and formula in Figure 30 can be used to calculate the output offset voltage.

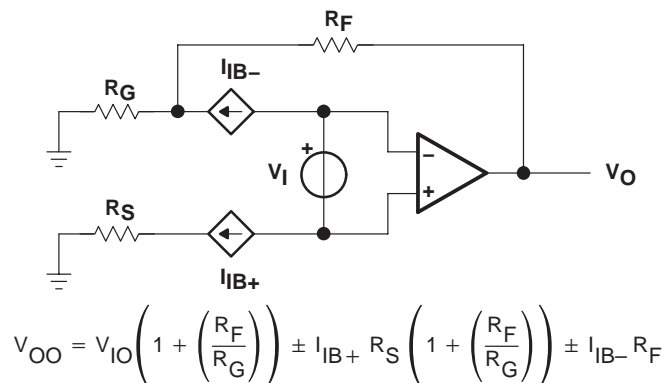

Figure 30. Output Offset Voltage Model

APPLICATION INFORMATION

general configurations

When receiving low-level signals, limiting the bandwidth of the incoming signals into the system is often required. The simplest way to accomplish this is to place an RC filter at the noninverting terminal of the amplifier (see Figure 31).

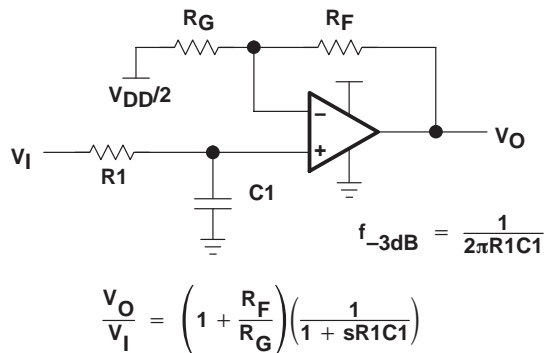

Figure 31. Single-Pole Low-Pass Filter

If even more attenuation is needed, a multiple pole filter is required. The Sallen-Key filter can be used for this task. For best results, the amplifier should have a bandwidth that is 8 to 10 times the filter frequency bandwidth. Failure to do this can result in phase shift of the amplifier.

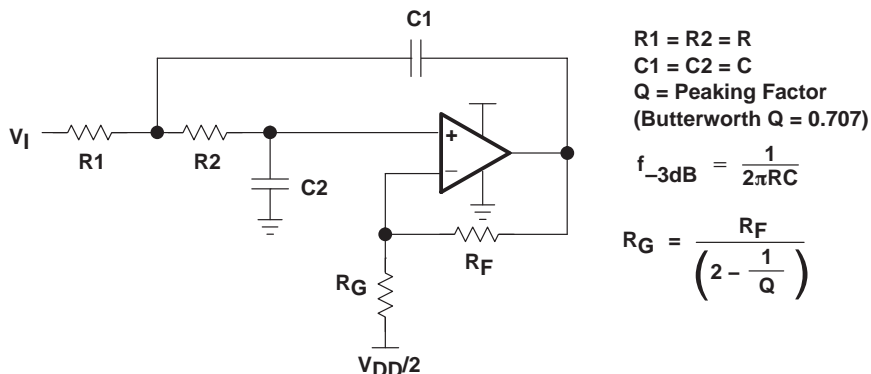

Figure 32. 2-Pole Low-Pass Sallen-Key Filter

APPLICATION INFORMATION

circuit layout considerations

To achieve the levels of high performance of the TLV237x, follow proper printed-circuit board design techniques. The following is a general set of guidelines.

- Ground planes—It is highly recommended that a ground plane be used on the board to provide all components with a low inductive ground connection. However, in the areas of the amplifier inputs and output, the ground plane can be removed to minimize the stray capacitance.
- Proper power supply decoupling—Use a 6.8- μ F tantalum capacitor in parallel with a 0.1- μ F ceramic capacitor on each supply terminal. It may be possible to share the tantalum capacitor among several amplifiers depending on the application, but a 0.1- μ F ceramic capacitor should always be used on the supply terminal of every amplifier. In addition, the 0.1- μ F capacitor should be placed as close as possible to the supply terminal. As this distance increases, the inductance in the connecting trace makes the capacitor less effective. The designer should strive for distances of less than 0.1 inches between the device power terminals and the ceramic capacitors.
- Sockets—Sockets can be used but are not recommended. The additional lead inductance in the socket pins often leads to stability problems. Surface-mount packages soldered directly to the printed-circuit board is the best implementation.
- Short trace runs/compact part placements—Optimum high performance is achieved when stray series inductance has been minimized. To realize this, the circuit layout should be made as compact as possible, thereby minimizing the length of all trace runs. Particular attention should be paid to the inverting input of the amplifier. Its length should be kept as short as possible. This helps to minimize stray capacitance at the input of the amplifier.
- Surface-mount passive components—Using surface-mount passive components is recommended for high performance amplifier circuits for several reasons. First, because of the extremely low lead inductance of surface-mount components, the problem with stray series inductance is greatly reduced. Second, the small size of surface-mount components naturally leads to a more compact layout thereby minimizing both stray inductance and capacitance. If leaded components are used, it is recommended that the lead lengths be kept as short as possible.

TLV2371-EP, TLV2372-EP, TLV2374-EP
FAMILY OF 550-μA/Ch 3-MHz RAIL-TO-RAIL INPUT/OUTPUT
OPERATIONAL AMPLIFIERS

SGLS306A – APRIL 2005 – REVISED APRIL 2006

APPLICATION INFORMATION

general power dissipation considerations

For a given θ_{JA} , the maximum power dissipation is shown in Figure 33 and is calculated by the following formula:

$$P_D = \left(\frac{T_{MAX} - T_A}{\theta_{JA}} \right)$$

Where:

P_D = Maximum power dissipation of TLV237x IC (watts)

T_{MAX} = Absolute maximum junction temperature (150°C)

T_A = Free-ambient air temperature (°C)

θ_{JA} = $\theta_{JC} + \theta_{CA}$

θ_{JC} = Thermal coefficient from junction to case

θ_{CA} = Thermal coefficient from case to ambient air (°C/W)

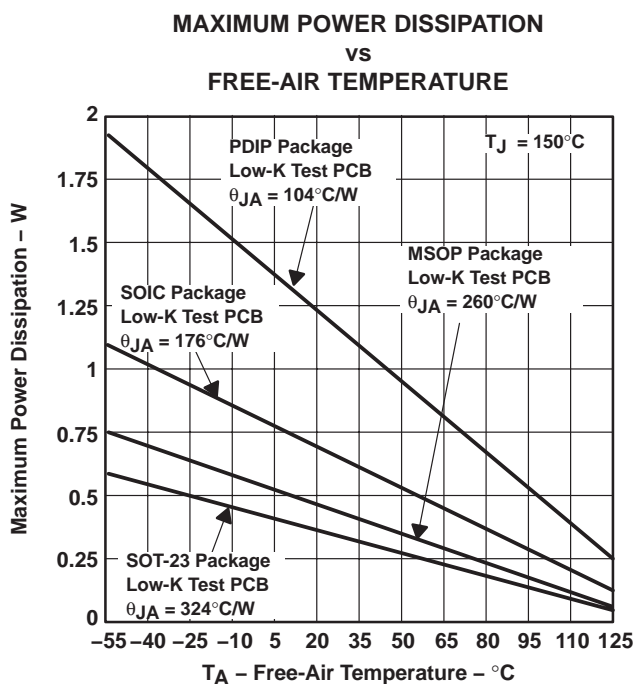

NOTE A: Results are with no air flow and using JEDEC Standard Low-K test PCB.

Figure 33.



PACKAGING INFORMATION

Orderable Device	Status (1)	Package Type	Package Drawing	Pins	Package Qty	Eco Plan (2)	Lead/Ball Finish (6)	MSL Peak Temp (3)	Op Temp (°C)	Device Marking (4/5)	Samples
TLV2371MDBVREP	ACTIVE	SOT-23	DBV	5	3000	Green (RoHS & no Sb/Br)	NIPDAU	Level-1-260C-UNLIM	-55 to 125	371E	Samples
TLV2374MDREP	ACTIVE	SOIC	D	14	2500	Green (RoHS & no Sb/Br)	NIPDAU	Level-1-260C-UNLIM	-55 to 125	TLV2374EP	Samples
V62/05611-01YE	ACTIVE	SOIC	D	14	2500	Green (RoHS & no Sb/Br)	NIPDAU	Level-1-260C-UNLIM	-55 to 125	TLV2374EP	Samples
V62/05611-03TE	ACTIVE	SOT-23	DBV	5	3000	Green (RoHS & no Sb/Br)	NIPDAU	Level-1-260C-UNLIM	-55 to 125	371E	Samples

(1) The marketing status values are defined as follows:

ACTIVE: Product device recommended for new designs.

LIFEBUY: TI has announced that the device will be discontinued, and a lifetime-buy period is in effect.

NRND: Not recommended for new designs. Device is in production to support existing customers, but TI does not recommend using this part in a new design.

PREVIEW: Device has been announced but is not in production. Samples may or may not be available.

OBsolete: TI has discontinued the production of the device.

(2) **RoHS:** TI defines "RoHS" to mean semiconductor products that are compliant with the current EU RoHS requirements for all 10 RoHS substances, including the requirement that RoHS substance do not exceed 0.1% by weight in homogeneous materials. Where designed to be soldered at high temperatures, "RoHS" products are suitable for use in specified lead-free processes. TI may reference these types of products as "Pb-Free".

RoHS Exempt: TI defines "RoHS Exempt" to mean products that contain lead but are compliant with EU RoHS pursuant to a specific EU RoHS exemption.

Green: TI defines "Green" to mean the content of Chlorine (Cl) and Bromine (Br) based flame retardants meet JS709B low halogen requirements of <=1000ppm threshold. Antimony trioxide based flame retardants must also meet the <=1000ppm threshold requirement.

(3) MSL, Peak Temp. - The Moisture Sensitivity Level rating according to the JEDEC industry standard classifications, and peak solder temperature.

(4) There may be additional marking, which relates to the logo, the lot trace code information, or the environmental category on the device.

(5) Multiple Device Markings will be inside parentheses. Only one Device Marking contained in parentheses and separated by a "-" will appear on a device. If a line is indented then it is a continuation of the previous line and the two combined represent the entire Device Marking for that device.

(6) Lead/Ball Finish - Orderable Devices may have multiple material finish options. Finish options are separated by a vertical ruled line. Lead/Ball Finish values may wrap to two lines if the finish value exceeds the maximum column width.

Important Information and Disclaimer:The information provided on this page represents TI's knowledge and belief as of the date that it is provided. TI bases its knowledge and belief on information provided by third parties, and makes no representation or warranty as to the accuracy of such information. Efforts are underway to better integrate information from third parties. TI has taken and

continues to take reasonable steps to provide representative and accurate information but may not have conducted destructive testing or chemical analysis on incoming materials and chemicals. TI and TI suppliers consider certain information to be proprietary, and thus CAS numbers and other limited information may not be available for release.

In no event shall TI's liability arising out of such information exceed the total purchase price of the TI part(s) at issue in this document sold by TI to Customer on an annual basis.

OTHER QUALIFIED VERSIONS OF TLV2371-EP, TLV2374-EP :

- Catalog: [TLV2371](#), [TLV2374](#)
- Automotive: [TLV2371-Q1](#), [TLV2374-Q1](#)

NOTE: Qualified Version Definitions:

- Catalog - TI's standard catalog product
- Automotive - Q100 devices qualified for high-reliability automotive applications targeting zero defects

TAPE AND REEL INFORMATION



QUADRANT ASSIGNMENTS FOR PIN 1 ORIENTATION IN TAPE



*All dimensions are nominal

Device	Package Type	Package Drawing	Pins	SPQ	Reel Diameter (mm)	Reel Width W1 (mm)	A0 (mm)	B0 (mm)	K0 (mm)	P1 (mm)	W (mm)	Pin1 Quadrant
TLV2371MDBVREP	SOT-23	DBV	5	3000	180.0	9.0	3.15	3.2	1.4	4.0	8.0	Q3
TLV2374MDREP	SOIC	D	14	2500	330.0	16.4	6.5	9.0	2.1	8.0	16.0	Q1

TAPE AND REEL BOX DIMENSIONS



*All dimensions are nominal

Device	Package Type	Package Drawing	Pins	SPQ	Length (mm)	Width (mm)	Height (mm)
TLV2371MDBVREP	SOT-23	DBV	5	3000	182.0	182.0	20.0
TLV2374MDREP	SOIC	D	14	2500	333.2	345.9	28.6



DBV0005A

PACKAGE OUTLINE

SOT-23 - 1.45 mm max height

SMALL OUTLINE TRANSISTOR

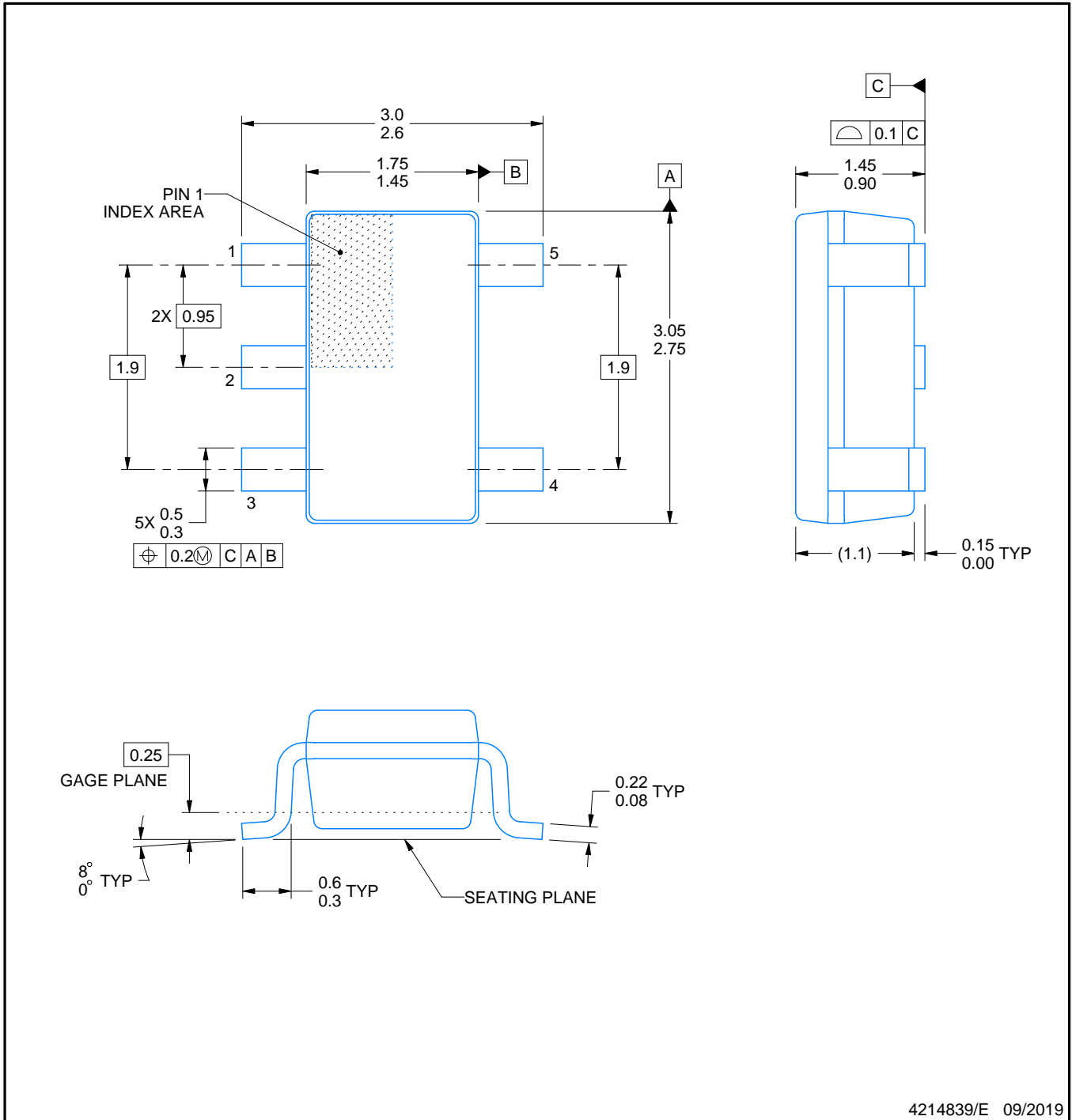

4214839/E 09/2019

NOTES:

1. All linear dimensions are in millimeters. Any dimensions in parenthesis are for reference only. Dimensioning and tolerancing per ASME Y14.5M.
2. This drawing is subject to change without notice.
3. Reference JEDEC MO-178.
4. Body dimensions do not include mold flash, protrusions, or gate burrs. Mold flash, protrusions, or gate burrs shall not exceed 0.15 mm per side.

EXAMPLE BOARD LAYOUT

DBV0005A

SOT-23 - 1.45 mm max height

SMALL OUTLINE TRANSISTOR



LAND PATTERN EXAMPLE
EXPOSED METAL SHOWN
SCALE:15X

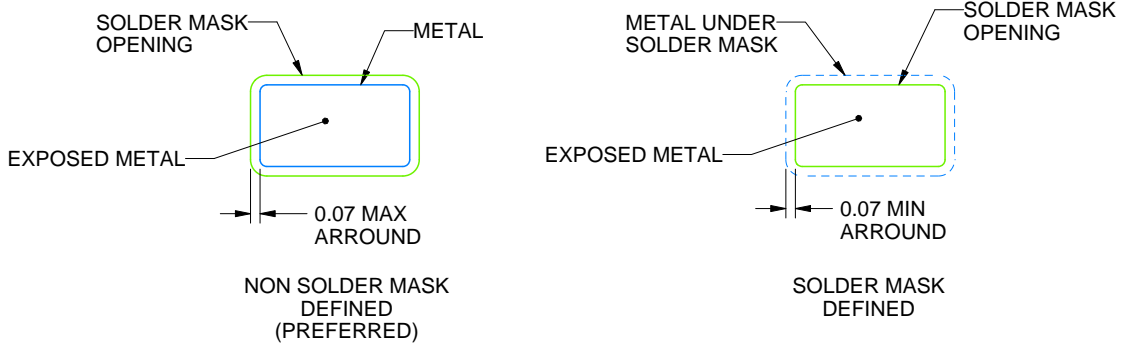

SOLDER MASK DETAILS

4214839/E 09/2019

NOTES: (continued)

- 5. Publication IPC-7351 may have alternate designs.
- 6. Solder mask tolerances between and around signal pads can vary based on board fabrication site.

EXAMPLE STENCIL DESIGN

DBV0005A

SOT-23 - 1.45 mm max height

SMALL OUTLINE TRANSISTOR



SOLDER PASTE EXAMPLE
BASED ON 0.125 mm THICK STENCIL
SCALE:15X

4214839/E 09/2019

NOTES: (continued)

7. Laser cutting apertures with trapezoidal walls and rounded corners may offer better paste release. IPC-7525 may have alternate design recommendations.
8. Board assembly site may have different recommendations for stencil design.

D (R-PDSO-G14)

PLASTIC SMALL OUTLINE



- NOTES:
- A. All linear dimensions are in inches (millimeters).
 - B. This drawing is subject to change without notice.
 - C. Body length does not include mold flash, protrusions, or gate burrs. Mold flash, protrusions, or gate burrs shall not exceed 0.006 (0,15) each side.
 - D. Body width does not include interlead flash. Interlead flash shall not exceed 0.017 (0,43) each side.
 - E. Reference JEDEC MS-012 variation AB.

D (R-PDSO-G14)

PLASTIC SMALL OUTLINE



- NOTES:
- A. All linear dimensions are in millimeters.
 - B. This drawing is subject to change without notice.
 - C. Publication IPC-7351 is recommended for alternate designs.
 - D. Laser cutting apertures with trapezoidal walls and also rounding corners will offer better paste release. Customers should contact their board assembly site for stencil design recommendations. Refer to IPC-7525 for other stencil recommendations.
 - E. Customers should contact their board fabrication site for solder mask tolerances between and around signal pads.

IMPORTANT NOTICE AND DISCLAIMER

TI PROVIDES TECHNICAL AND RELIABILITY DATA (INCLUDING DATASHEETS), DESIGN RESOURCES (INCLUDING REFERENCE DESIGNS), APPLICATION OR OTHER DESIGN ADVICE, WEB TOOLS, SAFETY INFORMATION, AND OTHER RESOURCES "AS IS" AND WITH ALL FAULTS, AND DISCLAIMS ALL WARRANTIES, EXPRESS AND IMPLIED, INCLUDING WITHOUT LIMITATION ANY IMPLIED WARRANTIES OF MERCHANTABILITY, FITNESS FOR A PARTICULAR PURPOSE OR NON-INFRINGEMENT OF THIRD PARTY INTELLECTUAL PROPERTY RIGHTS.

These resources are intended for skilled developers designing with TI products. You are solely responsible for (1) selecting the appropriate TI products for your application, (2) designing, validating and testing your application, and (3) ensuring your application meets applicable standards, and any other safety, security, or other requirements. These resources are subject to change without notice. TI grants you permission to use these resources only for development of an application that uses the TI products described in the resource. Other reproduction and display of these resources is prohibited. No license is granted to any other TI intellectual property right or to any third party intellectual property right. TI disclaims responsibility for, and you will fully indemnify TI and its representatives against, any claims, damages, costs, losses, and liabilities arising out of your use of these resources.

TI's products are provided subject to TI's Terms of Sale (www.ti.com/legal/termsofsale.html) or other applicable terms available either on ti.com or provided in conjunction with such TI products. TI's provision of these resources does not expand or otherwise alter TI's applicable warranties or warranty disclaimers for TI products.

Mailing Address: Texas Instruments, Post Office Box 655303, Dallas, Texas 75265
Copyright © 2020, Texas Instruments Incorporated