



**MICROCHIP**

---

**Digital Power Starter Kit  
User's Guide**

---

**Note the following details of the code protection feature on Microchip devices:**

- Microchip products meet the specification contained in their particular Microchip Data Sheet.
- Microchip believes that its family of products is one of the most secure families of its kind on the market today, when used in the intended manner and under normal conditions.
- There are dishonest and possibly illegal methods used to breach the code protection feature. All of these methods, to our knowledge, require using the Microchip products in a manner outside the operating specifications contained in Microchip's Data Sheets. Most likely, the person doing so is engaged in theft of intellectual property.
- Microchip is willing to work with the customer who is concerned about the integrity of their code.
- Neither Microchip nor any other semiconductor manufacturer can guarantee the security of their code. Code protection does not mean that we are guaranteeing the product as "unbreakable."

Code protection is constantly evolving. We at Microchip are committed to continuously improving the code protection features of our products. Attempts to break Microchip's code protection feature may be a violation of the Digital Millennium Copyright Act. If such acts allow unauthorized access to your software or other copyrighted work, you may have a right to sue for relief under that Act.

---

Information contained in this publication regarding device applications and the like is provided only for your convenience and may be superseded by updates. It is your responsibility to ensure that your application meets with your specifications. MICROCHIP MAKES NO REPRESENTATIONS OR WARRANTIES OF ANY KIND WHETHER EXPRESS OR IMPLIED, WRITTEN OR ORAL, STATUTORY OR OTHERWISE, RELATED TO THE INFORMATION, INCLUDING BUT NOT LIMITED TO ITS CONDITION, QUALITY, PERFORMANCE, MERCHANTABILITY OR FITNESS FOR PURPOSE. Microchip disclaims all liability arising from this information and its use. Use of Microchip devices in life support and/or safety applications is entirely at the buyer's risk, and the buyer agrees to defend, indemnify and hold harmless Microchip from any and all damages, claims, suits, or expenses resulting from such use. No licenses are conveyed, implicitly or otherwise, under any Microchip intellectual property rights.

**Trademarks**

The Microchip name and logo, the Microchip logo, dsPIC, KEELOQ, KEELOQ logo, MPLAB, PIC, PICmicro, PICSTART, PIC<sup>32</sup> logo, rfPIC and UNI/O are registered trademarks of Microchip Technology Incorporated in the U.S.A. and other countries.

FilterLab, Hampshire, HI-TECH C, Linear Active Thermistor, MXDEV, MXLAB, SEEVAL and The Embedded Control Solutions Company are registered trademarks of Microchip Technology Incorporated in the U.S.A.

Analog-for-the-Digital Age, Application Maestro, chipKIT, chipKIT logo, CodeGuard, dsPICDEM, dsPICDEM.net, dsPICworks, dsSPEAK, ECAN, ECONOMONITOR, FanSense, HI-TIDE, In-Circuit Serial Programming, ICSP, Mindi, MiWi, MPASM, MPLAB Certified logo, MPLIB, MPLINK, mTouch, Omniscient Code Generation, PICC, PICC-18, PICDEM, PICDEM.net, PICkit, PICtail, REAL ICE, rfLAB, Select Mode, Total Endurance, TSHARC, UniWinDriver, WiperLock and ZENA are trademarks of Microchip Technology Incorporated in the U.S.A. and other countries.

SQTP is a service mark of Microchip Technology Incorporated in the U.S.A.

All other trademarks mentioned herein are property of their respective companies.

© 2012, Microchip Technology Incorporated, Printed in the U.S.A., All Rights Reserved.

 Printed on recycled paper.

ISBN: 978-1-62076-353-7

*Microchip received ISO/TS-16949:2009 certification for its worldwide headquarters, design and wafer fabrication facilities in Chandler and Tempe, Arizona; Gresham, Oregon and design centers in California and India. The Company's quality system processes and procedures are for its PIC<sup>®</sup> MCUs and dsPIC<sup>®</sup> DSCs, KEELOQ<sup>®</sup> code hopping devices, Serial EEPROMs, microperipherals, nonvolatile memory and analog products. In addition, Microchip's quality system for the design and manufacture of development systems is ISO 9001:2000 certified.*

---

**QUALITY MANAGEMENT SYSTEM  
CERTIFIED BY DNV  
= ISO/TS 16949 =**

Manufacturer: Microchip Technology Inc.  
2355 W. Chandler Blvd.  
Chandler, Arizona, 85224-6199  
USA

This declaration of conformity is issued by the manufacturer.

The development/evaluation tool is designed to be used for research and development in a laboratory environment. This development/evaluation tool is not a Finished Appliance, nor is it intended for incorporation into Finished Appliances that are made commercially available as single functional units to end users under EU EMC Directive 2004/108/EC and as supported by the European Commission's Guide for the EMC Directive 2004/108/EC (8<sup>th</sup> February 2010).

This development/evaluation tool complies with EU RoHS2 Directive 2011/65/EU.

For information regarding the exclusive, limited warranties applicable to Microchip products, please see Microchip's standard terms and conditions of sale, which are printed on our sales documentation and available at [www.microchip.com](http://www.microchip.com).

Signed for and on behalf of Microchip Technology Inc. at Chandler, Arizona, USA



Derek Carlson  
VP Development Tools



Date

# Digital Power Starter Kit User's Guide

---

NOTES:

---

---

**Safety Notice**

---

---

The following safety notices and operating instructions should be adhered to avoid a safety hazard. If in any doubt, consult your supplier.



**DANGER** – The Digital Power Starter Kit contains two resistive loads that are intended to dissipate power in the form of heat. Depending on the output power level, it is possible for the resistive load to become hot to the touch or to any surface in direct contact with the board.



**WARNING** – The Digital Power Starter Kit should only be installed, operated, serviced or modified by qualified personnel. Any service or modification performed by the user is done at the user's own risk and voids all warranties.



**CAUTION** – Particular care should be taken during code development as unexpected voltage regulation behavior is possible. Ensure that the power supply connected to the Digital Power Starter Kit is properly protected against overcurrent event caused by code development.

**General Notices:**

- The Digital Power Starter Kit is intended for evaluation and development purposes and should only be operated in a normal laboratory environment as defined by IEC 61010-1:2001.
- Clean with a dry cloth only.
- Operate flat on a bench away from any surface items that might become in contact with the board. Do not move during operation and avoid direct contact with the bottom layer of the board.
- The Digital Power Starter Kit should not be connected or operated if there is any apparent damage to the unit.

# Digital Power Starter Kit User's Guide

---

NOTES:



# DIGITAL POWER STARTER KIT USER'S GUIDE

---

---

## Table of Contents

---

---

<b>Safety Notice</b> .....	<b>5</b>
<b>Preface</b> .....	<b>9</b>
<b>Chapter 1. Introduction</b>	
1.1 Overview .....	15
1.2 Kit Contents .....	15
1.3 Starter Kit Functionality and Features .....	16
1.4 Electrical Specifications .....	18
<b>Chapter 2. Hardware</b>	
2.1 Top Assembly .....	19
2.2 Signal Configuration .....	21
2.3 Application Components .....	22
2.4 Board Connectors .....	23
2.5 Indicators and Human Interfaces .....	23
2.6 Test Points .....	24
2.7 Power Rating of Converter Stages .....	25
2.8 Programmer/Debugger .....	26
<b>Chapter 3. Demonstration Program Operation</b>	
3.1 Program Demonstration .....	27
3.2 Code Demonstration .....	29
3.3 Other Code Examples .....	29
<b>Appendix A. Board Layout and Schematics</b> .....	<b>31</b>
<b>Worldwide Sales and Service</b> .....	<b>38</b>

# Digital Power Starter Kit User's Guide

---

---

NOTES:



---

---

## Preface

---

---

### NOTICE TO CUSTOMERS

All documentation becomes dated, and this manual is no exception. Microchip tools and documentation are constantly evolving to meet customer needs, so some actual dialogs and/or tool descriptions may differ from those in this document. Please refer to our web site ([www.microchip.com](http://www.microchip.com)) to obtain the latest documentation available.

Documents are identified with a “DS” number. This number is located on the bottom of each page, in front of the page number. The numbering convention for the DS number is “DSXXXXXA”, where “XXXXX” is the document number and “A” is the revision level of the document.

For the most up-to-date information on development tools, see the MPLAB® IDE on-line help. Select the Help menu, and then Topics to open a list of available on-line help files.

## INTRODUCTION

This preface contains general information that will be useful to know before using the Digital Power Starter Kit. Topics discussed in this preface include:

- [Document Layout](#)
- [Conventions Used in this Guide](#)
- [Warranty Registration](#)
- [Recommended Reading](#)
- [The Microchip Web Site](#)
- [Development Systems Customer Change Notification Service](#)
- [Customer Support](#)
- [Document Revision History](#)

## DOCUMENT LAYOUT

This user's guide provides an overview of the Digital Power Starter Kit. The document is organized as follows:

- **Chapter 1. “Introduction”** – This chapter introduces the Digital Power Starter Kit and provides a brief overview of its features.
- **Chapter 2. “Hardware”** – This chapter describes the board layout and the main components of the Digital Power Starter Kit.
- **Chapter 3. “Demonstration Program Operation”** – This chapter describes the demonstration software that is preloaded on the device that accompanies the Digital Power Starter Kit.
- **Appendix A. “Board Layout and Schematics”** – This appendix provides diagrams of the hardware layout, as well as schematic diagrams for the Digital Power Starter Kit.

# Digital Power Starter Kit User's Guide

## CONVENTIONS USED IN THIS GUIDE

This manual uses the following documentation conventions:

### DOCUMENTATION CONVENTIONS

Description	Represents	Examples
<b>Arial font:</b>		
Italic characters	Referenced books	<i>MPLAB<sup>®</sup> IDE User's Guide</i>
	Emphasized text	...is the <i>only</i> compiler...
Initial caps	A window	the Output window
	A dialog	the Settings dialog
	A menu selection	select Enable Programmer
Quotes	A field name in a window or dialog	"Save project before build"
Underlined, italic text with right angle bracket	A menu path	<u><i>File&gt;Save</i></u>
Bold characters	A dialog button	Click <b>OK</b>
	A tab	Click the <b>Power</b> tab
N'Rnnnn	A number in verilog format, where N is the total number of digits, R is the radix and n is a digit.	4'b0010, 2'hF1
Text in angle brackets < >	A key on the keyboard	Press <Enter>, <F1>
<b>Courier New font:</b>		
Plain Courier New	Sample source code	#define START
	Filenames	autoexec.bat
	File paths	c:\mcc18\h
	Keywords	_asm, _endasm, static
	Command-line options	-Opa+, -Opa-
	Bit values	0, 1
	Constants	0xFF, 'A'
Italic Courier New	A variable argument	<i>file.o</i> , where <i>file</i> can be any valid filename
Square brackets [ ]	Optional arguments	mcc18 [options] <i>file</i> [options]
Curly braces and pipe character: {   }	Choice of mutually exclusive arguments; an OR selection	errorlevel {0 1}
Ellipses...	Replaces repeated text	var_name [, var_name...]
	Represents code supplied by user	void main (void) { ... }

## WARRANTY REGISTRATION

Please complete the enclosed Warranty Registration Card and mail it promptly. Sending in the Warranty Registration Card entitles users to receive new product updates. Interim software releases are available at the Microchip web site.

## RECOMMENDED READING

This user's guide describes how to use the Digital Power Starter Kit. The device-specific data sheets contain current information on programming the specific microcontroller or digital signal controller devices. The following Microchip documents are available and recommended as supplemental reference resources:

### **MPLAB<sup>®</sup> C Compiler for PIC24 MCUs and dsPIC<sup>®</sup> DSCs User's Guide (DS51284)**

This comprehensive guide describes the usage, operation and features of Microchip's MPLAB C compiler (formerly MPLAB C30) for use with 16-bit devices.

### **MPLAB<sup>®</sup> IDE User's Guide (DS51519)**

This user's guide describes how to set up the MPLAB IDE software and use it to create projects and program devices.

### **MPLAB X IDE User's Guide (DS52027)**

This document describes how to set up the MPLAB X IDE software and use it to create projects and program devices.

### **Readme Files**

For the latest information on using the Digital Power Starter Kit Board, read the `Readme.txt` text file in the `Readme` subdirectory of the MPLAB IDE installation directory from the Digital Power Starter Kit code example. The `Readme` file contains update information and known issues that may not be included in this user's guide.

### **dsPIC33FJ06GS001/101A/102A/202A and dsPIC33FJ09GS302 Data Sheet (DS75018)**

Refer to this document for detailed information on this family of dsPIC33F SMPS Digital Signal Controllers (DSCs). Reference information found in this data sheet includes:

- Device memory maps
- Device pinout and packaging details
- Device electrical specifications
- List of peripherals included on the devices

### **dsPIC33F/PIC24H Family Reference Manual Sections**

Family Reference Manual (FRM) sections are available, which explain the operation of the dsPIC<sup>®</sup> DSC and PIC24H MCU family architecture and peripheral modules. The specifics of each device family are discussed in the individual family's device data sheet.

### **dsPIC33F Flash Programming Specification for Devices with Volatile Configuration Bits (DS70659)**

Refer to this document for information on instruction sets and firmware development.

### **Microchip SMPS Resources**

- AN1114 “Switch Mode Power Supply (SMPS) Topologies (Part I)” (DS01114)
- AN1207 “Switch Mode Power Supply (SMPS) Topologies (Part II)” (DS01207)
- TB062 “Frequently Asked Questions (FAQs) About dsPIC<sup>®</sup> DSC SMPS Devices” (DS93062)

To obtain any of these documents, visit the Microchip web site at [www.microchip.com](http://www.microchip.com).

# Digital Power Starter Kit User's Guide

---

## THE MICROCHIP WEB SITE

Microchip provides online support via our web site at [www.microchip.com](http://www.microchip.com). This web site is used as a means to make files and information easily available to customers. Accessible by using your favorite Internet browser, the web site contains the following information:

- **Product Support** – Data sheets and errata, application notes and sample programs, design resources, user's guides and hardware support documents, latest software releases and archived software
- **General Technical Support** – Frequently Asked Questions (FAQs), technical support requests, online discussion groups, Microchip consultant program member listing
- **Business of Microchip** – Product selector and ordering guides, latest Microchip press releases, listing of seminars and events, listings of Microchip sales offices, distributors and factory representatives

## DEVELOPMENT SYSTEMS CUSTOMER CHANGE NOTIFICATION SERVICE

Microchip's customer notification service helps keep customers current on Microchip products. Subscribers will receive e-mail notification whenever there are changes, updates, revisions or errata related to a specified product family or development tool of interest.

To register, access the Microchip web site at [www.microchip.com](http://www.microchip.com), click on Customer Change Notification and follow the registration instructions.

The Development Systems product group categories are:

- **Compilers** – The latest information on Microchip C compilers and other language tools. These include the MPLAB<sup>®</sup> C compiler; MPASM<sup>™</sup> and MPLAB 16-bit assemblers; MPLINK<sup>™</sup> and MPLAB 16-bit object linkers; and MPLIB<sup>™</sup> and MPLAB 16-bit object librarians.
- **Emulators** – The latest information on the Microchip MPLAB REAL ICE<sup>™</sup> in-circuit emulator.
- **In-Circuit Debuggers** – The latest information on the Microchip in-circuit debugger, MPLAB ICD 3.
- **MPLAB IDE** – The latest information on Microchip MPLAB IDE, the Windows<sup>®</sup> Integrated Development Environment for development systems tools. This list is focused on the MPLAB IDE, MPLAB SIM simulator, MPLAB IDE Project Manager and general editing and debugging features.
- **Programmers** – The latest information on Microchip programmers. These include the MPLAB PM3 device programmer and the PICKit<sup>™</sup> 3 development programmers.

## CUSTOMER SUPPORT

Users of Microchip products can receive assistance through several channels:

- Distributor or Representative
- Local Sales Office
- Field Application Engineer (FAE)
- Technical Support

Customers should contact their distributor, representative or field application engineer (FAE) for support. Local sales offices are also available to help customers. A listing of sales offices and locations is included in the back of this document.

Technical support is available through the web site at: <http://support.microchip.com>

## DOCUMENT REVISION HISTORY

### Revision A (June 2012)

This is the initial released version of the document.

# Digital Power Starter Kit User's Guide

---

NOTES:

---

---

## Chapter 1. Introduction

---

---

This chapter introduces the Digital Power Starter Kit and provides an overview of its features. The topics covered include:

- [Kit Contents](#)
- [Starter Kit Functionality and Features](#)
- [Electrical Specifications](#)

### 1.1 OVERVIEW

Modern power supplies are becoming smaller, more efficient, more flexible and less expensive. These desirable enhancements have come about as Digital Signal Controllers (DSCs) are incorporated into Switch Mode Power Supply (SMPS) designs. The board provided in the kit is intended to introduce and demonstrate the capabilities and features of Microchip SMPS families of devices. The Digital Power Starter Kit features an on-board programmer/debugger, which eliminates the need for any additional programmer or hardware interface.

The software for the demonstration application that is preprogrammed into the on-board dsPIC33F Digital Signal Controller (DSC) is available for download from the Microchip web site at: <http://www.microchip.com>.

**Note:** Refer to the Readme file provided with the Digital Power Starter Kit demonstration software for instructions on how to run the demonstration application. Refer to the Information Sheet that is provided with the starter kit package for additional resources and instructions on how to use the starter kit for programming and debugging application software.

### 1.2 KIT CONTENTS

The Digital Power Starter Kit contains the following:

- Digital Power Starter Kit Board
- 9V Power Supply
- USB Cable

**Note:** If you are missing any part of the kit, contact a Microchip sales office for assistance. A list of worldwide Microchip offices for sales and service is provided at the end of this document.

# Digital Power Starter Kit User's Guide

## 1.3 STARTER KIT FUNCTIONALITY AND FEATURES

The Digital Power Starter Kit is a power supply board that consists of one independent DC/DC synchronous Buck converter and one independent DC/DC Boost converter. Figure 1-1 illustrates a high-level block diagram of the Starter Kit.

The Digital Power Starter Kit provides closed-loop Proportional-Integral-Derivative (PID) control in the software to maintain the desired output voltage level. The dsPIC<sup>®</sup> DSC device provides the necessary memory and peripherals for A/D conversion, PWM generation, analog comparison and general purpose I/O, preventing the need to perform these functions in external circuitry.

SMPS dsPIC DSC devices are specifically designed to provide low-cost and efficient control for a wide range of power supply topologies. The specialized peripherals facilitate closed-loop feedback control of switch mode power supplies, providing communication for remote monitoring and supervisory control.

The dsPIC33F SMPS family of devices provide the following features:

- Integrated program and data memory on a single chip
- Ultra-fast interrupt response time with interrupt priority logic
- Up to 2 Msps, on-chip ADC with Successive Approximation Register (SAR), and three Sample-and-Hold (S&H) circuits.
- Three independent, high-resolution PWM generators, specially designed to support different power topologies
- Two high-speed analog comparators for control loop implementation and system protection
- On-chip system communications (I<sup>2</sup>C<sup>™</sup>/SPI/UART)
- On-chip fast RC oscillator for lower system cost
- High-current sink/source for PWM pins (16 mA/16 mA)
- CPU performance (40 MIPS)
- Extensive power-saving features

FIGURE 1-1: DIGITAL POWER STARTER KIT SYSTEM DIAGRAM

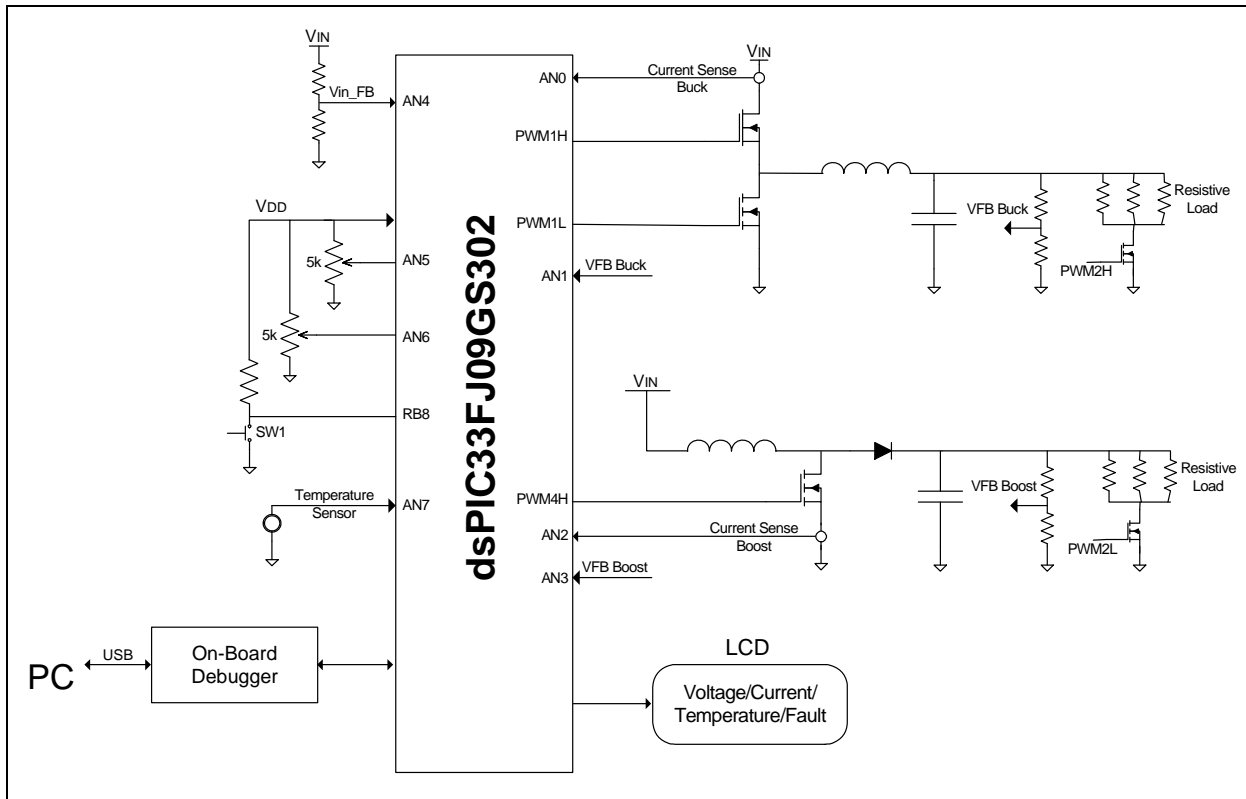



## 1.3.1 Power Stages

- One synchronous Buck converter power stage
- One Boost converter power stage
- Voltage/current measurement and display for digital controlled Buck converter
- Voltage/current measurement and display for digital controlled Boost converter
- MOSFET controlled 5W resistive load on Buck Converter Output (BUCK\_Out)
- MOSFET controlled 5W resistive load on Boost Converter Output (BOOST\_Out)

## 1.3.2 Additional Features

- 5 kOhm Potentiometers (P1 and P2), used to adjust the duty cycle of the load resistors
- On-board temperature sensor, located near the resistive load; this enables the user to program a temperature protection limit
- Input voltage sense, used to detect under/overvoltage conditions
- Connector for PICkit Serial Analyzer (J3)
- LED power-on indicator (D1)
- LED output voltage indicators (D5 and D12)
- LCD used to display voltage, current, temperature and Fault conditions

## 1.3.3 Starter Kit Power

- +9V power connector (J2) supplies power to the Digital Power Starter Kit
- USB connection jack (J5) supplies power/connection to the on-board debugger
- Buck and Boost converters are both operated in Voltage mode (default), but can also be reprogrammed to operate in Average Current or Peak Current Control mode

# Digital Power Starter Kit User's Guide

---

## 1.4 ELECTRICAL SPECIFICATIONS

**TABLE 1-1: DC INPUT RATING (J2)**

Parameter	Minimum	Typical	Maximum	Unit
Voltage	7.0	9	11	V
Current	1	—	—	A

**TABLE 1-2: BUCK CONVERTER ELECTRICAL SPECIFICATIONS**

Parameter	Minimum	Typical	Maximum	Unit
Output Voltage (default programmed)	—	3.3	—	V
Output Voltage (programmable range)	1.2	—	4.5	V
Output Voltage Ripple	—	50	—	mV (pk-pk)
Output Current	—	—	1.5	A
Load Regulation: V <sub>OUT</sub> = 3.3V, I <sub>OUT</sub> = 0.02-1.5A, V <sub>IN</sub> = 9V	—	50	—	mV/A
Switching Frequency	—	350	—	kHz
Output Power	—	—	5	W

**TABLE 1-3: BOOST CONVERTER ELECTRICAL SPECIFICATIONS**

Parameter	Minimum	Typical	Maximum	Unit
Output Voltage (default programmed)	—	15	—	V
Output Voltage (programmable range)	11	—	18	V
Output Voltage Ripple	—	100	—	mV (pk-pk)
Output Current	—	—	0.4	A
Load Regulation: V <sub>OUT</sub> = 15V, I <sub>OUT</sub> = 0.02-0.3A, V <sub>IN</sub> = 9V	—	50	—	mV/A
Switching Frequency	—	350	—	kHz
Output Power	—	—	5	W

## Chapter 2. Hardware

This chapter describes the hardware components of the Digital Power Starter Kit.

Topics covered include:

- [Top Assembly](#)
- [Signal Configuration](#)
- [Application Components](#)
- [Board Connectors](#)
- [Indicators and Human Interfaces](#)
- [Test Points](#)
- [Power Rating of Converter Stages](#)
- [Programmer/Debugger](#)

### 2.1 TOP ASSEMBLY

The top and bottom assembly of the board is shown in [Figure 2-1](#) and [Figure 2-2](#). [Table 2-1](#) and [Table 2-2](#) provide a description of the components.

**FIGURE 2-1: DIGITAL POWER STARTER KIT (TOP VIEW)**

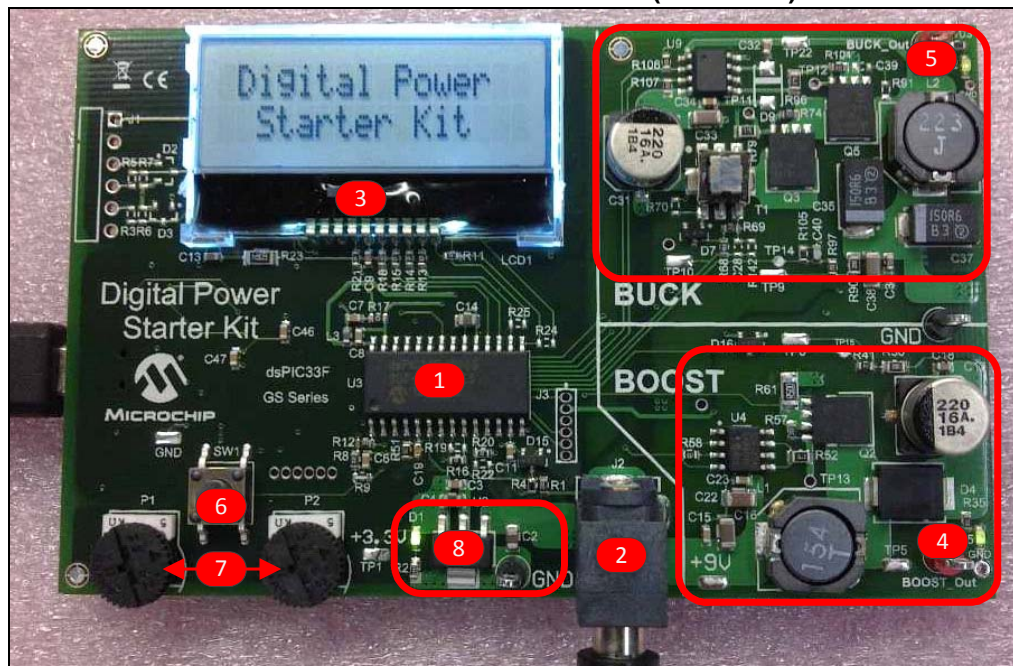

# Digital Power Starter Kit User's Guide

**TABLE 2-1: DIGITAL POWER STARTER KIT COMPONENTS (TOP)**

Number	Description
1	dsPIC33FJ09GS302 Digital Signal Controller (DSC) (U3)
2	9V Power Connector (J2)
3	2x16 Character LCD
4	Boost Converter Stage
5	Buck Converter Stage
6	Push Button (SW1)
7	Potentiometers (P1 and P2)
8	Voltage Regulator (3.3V)

**FIGURE 2-2: DIGITAL POWER STARTER KIT (BOTTOM VIEW)**

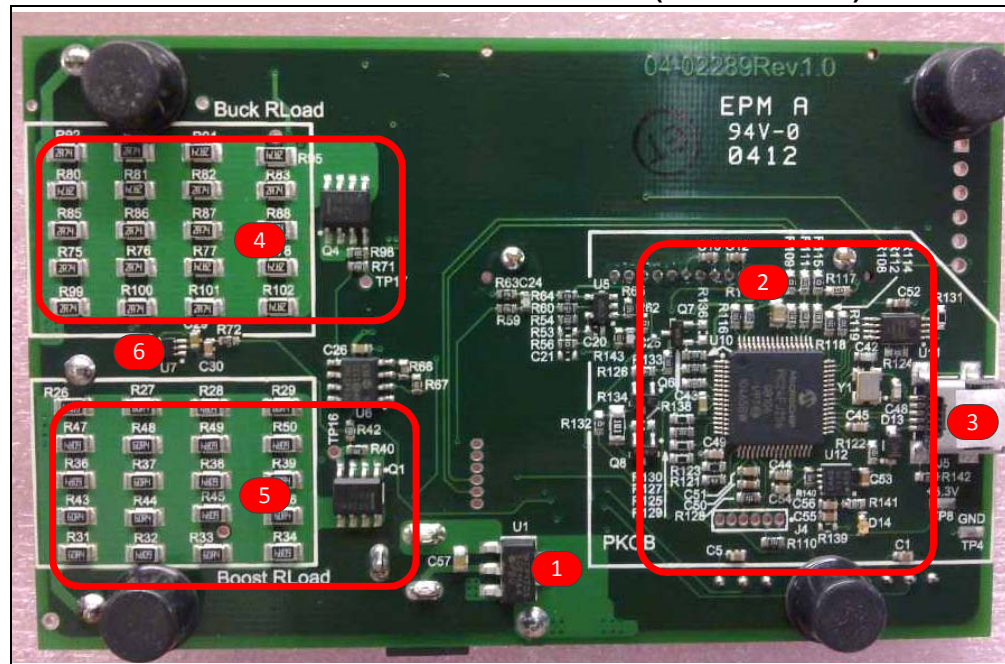

**TABLE 2-2: DIGITAL POWER STARTER KIT COMPONENTS (BOTTOM)**

Number	Description
1	Voltage Regulator (5V)
2	On-Board Programmer/Debugger
3	Programmer/Debugger USB Connector (J5)
4	Buck Converter Resistive Load
5	Boost Converter Resistive Load
6	On-Board Temperature Sensor

## 2.2 SIGNAL CONFIGURATION

Table 2-3 provides a full list of the dsPIC33FJ09GS302 DSC connections and a brief functional description of the pins used in the Digital Power Starter Kit.

**TABLE 2-3: dsPIC33FJ09GS302 CONFIGURATION DETAILS**

Digital Power Starter Kit Signal Label	dsPIC33FJ09GS302		Description/Function
	Pin #	Device Pin Name	
ICSP_MCLR_VPP_Target	1	MCLR	Master Clear (Reset) Input
CS_BUCK	2	AN0/CMP1A/RA0	Analog – Buck Current Sense
VFB_BUCK	3	AN1/CMP1B/RA1	Analog – Buck Voltage Feedback
CS_BOOST	4	AN2/CMP1C/CMP2A/RA2	Analog – Boost Current Sense
VFB_BOOST	5	AN3/CMP1D/CMP2B/RP0/CN0/RB0	Analog – Boost Voltage Feedback
VIN_FB	6	AN4/ISRC4/CMP2C/RP9/CN9/RB9	Analog – Input Voltage Feedback
EXT POT2	7	AN5/ISRC3/CMP2D/RP10/CN10/RB10	Analog – 5k Potentiometer
—	8	Vss	Ground
EXT POT1	9	OSC1/CLKI/AN6/ISRC2/RP1/CN1/RB1	Analog – 5k Potentiometer
Temp_Sensor	10	OSC2/CLKO/AN7/ISRC1//RP2/CN2/RB2	Analog – Temperature Sensor
PGD2	11	PGED2/DACOUT/INT0/RP3/CN3/RB3	Data I/O pin for programming/ debugging Communication Channel 2
PGC2	12	PGEC2/EXTREF/RP4/CN4/RB4	Clock Input pin for programming/ debugging Communication Channel 2
—	13	VDD	Positive Supply for peripheral logic and I/O pins
SW	14	PGED3/RP8/CN8/RB8	SW1 Push Button
LCD_Reset	15	PGEC3/RP15/CN15/RB15	LCD Active-Low Reset Signal
LCD_RSelect	16	TDO/RP5/CN5/RB5	LCD Register Select Signal
SCL/TX	17	PGED1/TDI/SCL1/RP6/CN6/RB6	LCD Serial Clock
SDA/RX	18	PGEC1/SDA1/RP7/CN7/RB7	LCD_Data
—	19	Vss	Ground
—	20	VCAP	CPU Logic Filter Capacitor Connection
PWM4H	21	TMS/RP11/CN11/RB11	Boost MOSFET PWM Signal
LCD_CSB	22	TCK/RP12/CN12/RB12	LCD Active-Low Chip Select Signal
Load BUCK	23	PWM2H/RP13/CN13/RB13	Buck-Resistive Load Driver PWM Signal
Load BOOST	24	PWM2L/RP14/CN14/RB14	Boost-Resistive Load Driver PWM Signal
PWM1H	25	PWM1H/RA4	Buck High Side MOSFET PWM Signal
PWM1L	26	PWM1L/RA3	Buck Low Side MOSFET PWM Signal
—	27	AVss	Ground Reference for analog modules
—	28	AVDD	Positive Supply for analog modules; this pin must be connected at all times

# Digital Power Starter Kit User's Guide

## 2.3 APPLICATION COMPONENTS

Table 2-4 describes the application components that are available on the Digital Power Starter Kit (see Figure 2-1 and Figure 2-2 for component locations).

TABLE 2-4: APPLICATION COMPONENTS

Component	Label	Item	Description
<b>Top Assembly Components (see Figure 2-1)</b>			
dsPIC33FJ09GS302 DSC	U3	1	Provides the processing power for the demonstration applications and application development on the starter kit. The MCU features 9 Kbytes of Flash program memory and 1 Kbyte of RAM. The demonstration application uses the MCU device's on-chip FRC oscillator with PLL as a clock source.
9V Power Connector	J2	2	A 9V power supply powers the dsPIC33FJ09GS302 DSC and supplies the power to both of the DC/DC converters on the starter kit. To operate the starter kit, connect the power supply provided with the starter kit to J2.
2x16 Character LCD	LCD1	3	User-programmable 2x16 character LCD.
Boost Converter Stage	N/A	4	5W step-up converter (Boost).
Buck Converter Stage	N/A	5	5W step-down converter (Buck).
Potentiometer	P1 & P2	7	Two Potentiometers (POTs). Each POT is connected to an analog input pin of the DSC, providing an analog reference voltage from 3.3V to ground (0V).
Voltage Regulator	U2	8	Voltage regulator (3.3V) provides power to the dsPIC33FJ09GS302 DSC, LCD, push button, potentiometers and temperature sensor.
<b>Bottom Assembly Components (see Figure 2-2)</b>			
Voltage Regulator	U1	1	Voltage regulator (5V) provides power to the 3.3V regulator and to the Buck stage gate driver (U9).
On-Board Programmer/Debugger	N/A	2	Controls the programming/debugging operations of the target dsPIC33FJ09GS302 DSC.
Programmer/Debugger USB Connector	J5	3	Provides power to the programmer/debugger and bidirectional communication between the host PC and starter kit.
Buck Resistive Load	N/A	4	MOSFET controlled 2.2 Ohm resistive load (5W max).
Boost Resistive Load	N/A	5	MOSFET controlled 48.3 Ohm resistive load (5W max).
On-Board Temperature Sensor	U7	6	The temperature sensor is strategically placed near the load resistors. It is intended to provide the board temperature to the DSC and to disable both of the resistive loads if the temperature exceeds the set limit.

## 2.4 BOARD CONNECTORS

Table 2-5 describes the hardware connections available on the Digital Power Starter Kit (see Figure 2-1 and Figure 2-2 for component locations).

**TABLE 2-5: HARDWARE CONNECTIONS**

Label	Hardware Element Description
J1	Connector for PICKit™ Serial Analyzer (not populated).
J2	9V power supply (not populated).
J3	ICSP™ programmer interface connector for programming the dsPIC33FJ09GS302 DSC.
J4	ICSP programmer interface connector for programming the PIC24FJ256GB106 MCU USB-to-UART bridge (not populated).
J5	Mini-USB connector provides bidirectional communication between the host PC and the on-board programmer/debugger.

## 2.5 INDICATORS AND HUMAN INTERFACES

Table 2-6 describes the user interfaces available on the starter kit.

**TABLE 2-6: INDICATORS AND HUMAN INTERFACES**

Label	Hardware Element Description
SW1	Push button switch, which is connected to the RB8 port pin. When momentarily pressed, the LCD measurement and board status information is changed.
D1	Power-on status LED, which indicates that the Digital Power Starter Kit is powered by the 9V supply.
D14	USB bus indicator, which indicates that the device is connected to the USB bus and the programmer/debugger is powered.
P1 and P2	Two variable resistors (potentiometers). Each potentiometer is connected to an analog input pin, providing an analog reference voltage from 3.3V to ground (0V).
D12	Buck converter power-on status LED, which indicates when the Buck DC/DC converter is enabled.
D5	Boost converter power-on status LED, which indicates when the Boost DC/DC converter is enabled. Because of the Boost configuration, this LED will be illuminated when +9V is present at the J2 connector.
LCD1	User-programmable 2x16 character LCD display.

# Digital Power Starter Kit User's Guide

## 2.6 TEST POINTS

Table 2-7 describes the test points that are available on the Digital Power Starter Kit. See Figure 2-3 for test point locations.

**TABLE 2-7: TEST POINTS**

Test Point	Description
+9V	9V Power Supply test point
BUCK_OUT	Output Voltage for the Buck Stage test point
BOOST_OUT	Output Voltage for the Boost Stage test point
TP1	3.3V Supply Voltage test point
TP5	Boost Stage Switch Node test point
TP6	Boost Stage BODE test point
TP9	Buck Stage BODE test point
TP10	Buck Stage Current Sense test point
TP11	Buck Stage High-Side MOSFET Gate Signal test point
TP12	Buck Stage Low-Side MOSFET Gate Signal test point
TP13	Boost Stage MOSFET Gate Signal test point
TP14	Buck Stage Output Voltage Feedback test point
TP15	Boost Stage Output Voltage Feedback test point
TP16	Resistive Load MOSFET Gate Signal (Boost) test point
TP17	Resistive Load MOSFET Gate Signal (Buck) test point
TP22	Buck Stage Switch Node test point

**FIGURE 2-3: DIGITAL POWER STARTER KIT TEST POINT LOCATIONS**

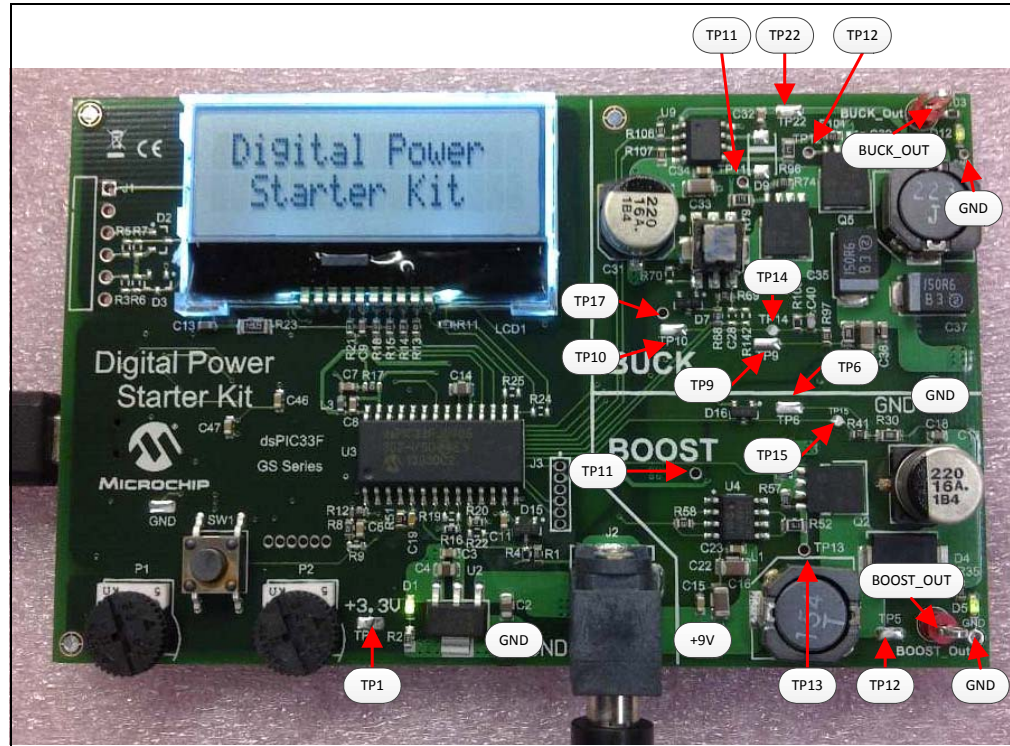



## 2.7 POWER RATING OF CONVERTER STAGES

The Digital Power Starter Kit is designed to be a self-contained power supply board with variable 5W loads connected to each DC/DC converter.

### 2.7.1 BUCK CONVERTER

The Buck converter stage is rated for a maximum power output of 5W to the dedicated on-board resistive load. The output voltage and output current should remain within its Safe Operating Area (SOA) to avoid damage to the board, as shown in the graph in [Figure 2-4](#). The output voltage of the Buck converter (BUCK\_Out) can be programmed to be from a 1.2V to 4.5V output, with a default programmed voltage of 3.3V. The hardware gain  $[5k/(3.3k + 5k)]$  of the voltage feedback from the BUCK\_Out is provided by the resistor divider network, R97 and R105. Additionally, a 20 Ohm resistor, R90, for bode plot measurements is also in series with the feedback network. The hardware gain of the current feedback is provided by the current transformer (T1) with turns ratio (1:60) and burden resistor, R69.

**FIGURE 2-4: BUCK CONVERTER SOA CURVE**

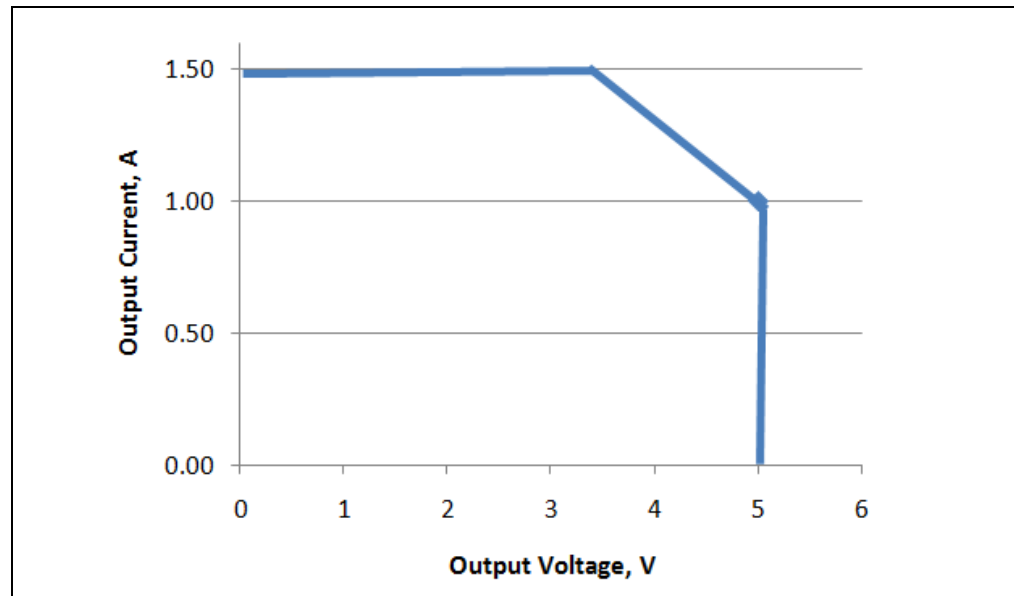

# Digital Power Starter Kit User's Guide

## 2.7.2 Boost Converter

The Boost converter stage is rated for a maximum output power of 5W to the dedicated on-board resistive load. The output voltage and output current should remain within the Boost converter Safe Operating Area (SOA) to avoid damage to the board, as shown in the graph in [Figure 2-5](#). The output voltage of the Boost converter (BOOST\_Out) can be programmed to be from an 11V to 18V output, with a default programmed voltage of 15V. The hardware gain  $[20k/(20k + 3.3k)]$  of the voltage feedback from the BOOST\_Out is provided by the resistor divider network of R41 and R51. Additionally, a 20 Ohm resistor, R30, for bode plot measurements is also in series with the feedback network. The hardware gain of the current feedback is provided by the current sense resistor, R61.

**FIGURE 2-5: BOOST CONVERTER SOA CURVE**

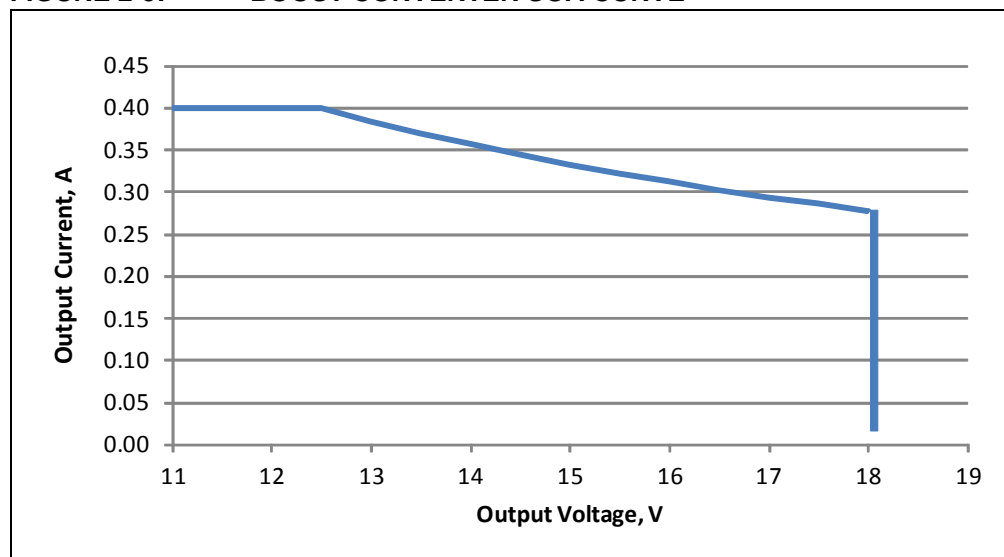

## 2.8 PROGRAMMER/DEBUGGER

The Digital Power Starter Kit includes an on-board programmer/debugger circuit that provides connectivity over USB. This circuit is hard-wired to the dsPIC DSC device to provide ICSP™ debugging/programming capability.

### 2.8.1 Programmer/Debugger Components

[Table 2-8](#) describes the programmer/debugger components that are available on the Digital Power Starter Kit (see [Figure 2-2](#) for component locations).

**TABLE 2-8: PROGRAMMER/DEBUGGER COMPONENTS**

Component	Label	Item #	Description
On-Board Programmer/Debugger	N/A	2	Controls the programming/debugging operations of the target dsPIC33FJ09GS302 DSC.
Programmer/Debugger USB Connector	J5	3	Provides power to the programmer/debugger, and bidirectional communication between the host PC and the Digital Power Starter Kit.

---

---

## Chapter 3. Demonstration Program Operation

---

---

The dsPIC33FJ09GS302 Digital Power Starter Kit is preprogrammed with a demonstration application that illustrates simultaneous Proportional-Integral-Derivative (PID) control of the output voltage for the two DC/DC converter circuits on board the Digital Power Starter Kit. This code can be downloaded from the Microchip web site ([www.microchip.com](http://www.microchip.com)).

This section covers the following topics:

- [Program Demonstration](#)
- [Code Demonstration](#)
- [Other Code Examples](#)

### 3.1 PROGRAM DEMONSTRATION

The demonstration program provides simultaneous closed-loop control of the output voltage for both DC/DC converter stages of the Digital Power Starter Kit.

One PID loop controls the Buck converter output voltage (BUCK\_Out) at 3.3V. The other PID loop controls the Boost converter output voltage (BOOST\_Out) at 15V.

The PID control scheme consists of the following parameters:

- Proportional Error Gain (P-Gain) – This parameter produces a correction factor that is proportional to the magnitude of the output voltage error.
- Integral Error Gain (I-Gain) – This parameter uses the cumulative voltage error to generate a correction factor that eliminates any residual error due to limitations in offset voltages and measurement resolution.
- Derivative Error Gain (D-Gain) – This parameter produces a correction factor that is proportional to the rate of change of the output error voltage, which helps the system respond quickly to changes in system conditions.

The demonstration program requires no manual preparation except to connect 9V power to the J2 connector.

# Digital Power Starter Kit User's Guide

FIGURE 3-1: SMPS DEMONSTRATION PROGRAM FLOW CHART

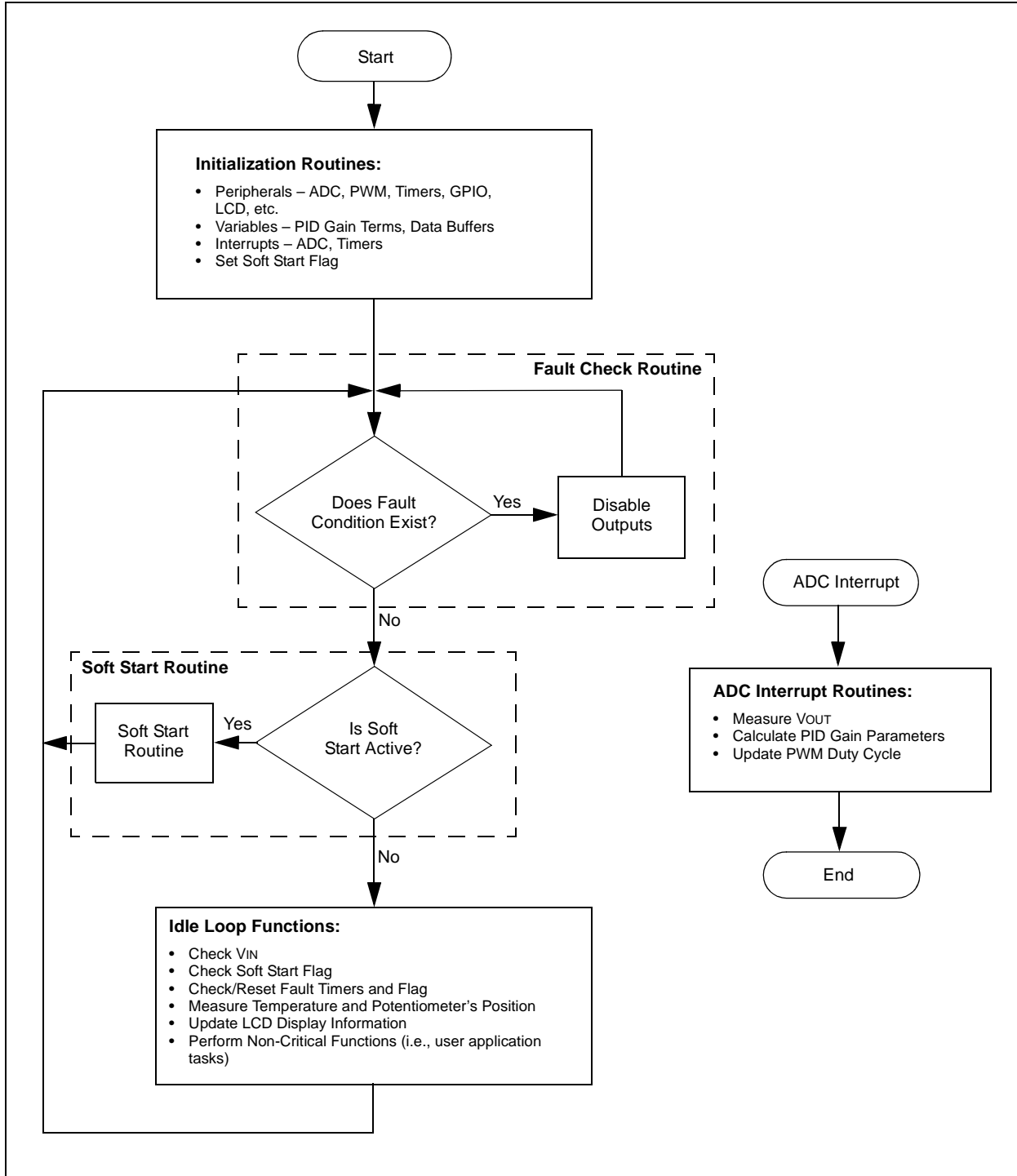

## 3.2 CODE DEMONSTRATION

### 3.2.1 System Initialization

When power is applied to the board, the program starts by executing the following system initialization routines:

- Peripherals – The required peripherals (PWM, ADC, Timers and GPIO) are configured and enabled
- Variables – Program variables are defined. RAM locations and register usage are defined and documented
- Constants – Program constants are defined, including reference set points for both Buck output voltage and Boost output voltage, input voltage, current limits, Fault conditions, PWM periods and Timer periods
- Interrupts – The ADC and Timer interrupts are set up and enabled

### 3.2.2 Fault Check

The program checks for input under/overvoltage, output overvoltage and board temperature limit. If a Fault occurs, the PWM outputs are disabled until the Fault condition is cleared. If no Fault is detected, the program proceeds.

### 3.2.3 Soft Start

The Soft Start routine ramps up the output voltage in a close-loop fashion to bring the system within the operating range of the PID control loop. This routine ensures that the output does not overshoot the desired voltage; it also limits the current at start-up.

### 3.2.4 ADC Interrupt

The ADC interrupt is the heart of the demo program. This routine takes up approximately 75% of the execution time. It performs all the PID calculations and applies any needed corrections to the output.

**Note:** The ADC interrupt can occur any time during program execution. The ADC interrupt takes priority over any other tasks that the program is performing.

### 3.2.5 System Idle Loop

All auxiliary functions are performed in the system Idle routine. This is the time available to the CPU while the demo program is waiting for an ADC interrupt. Non-critical functions can be performed in this loop. During this time the LCD is refreshed, the potentiometers position, input voltage, Fault timers and Soft Start flag are checked.

## 3.3 OTHER CODE EXAMPLES

There are several other SMPS code examples available on the Microchip web site. Refer to the Readme files located in each code example folder for details on what each code example demonstrates. Check the Microchip web site ([www.microchip.com/SMPS](http://www.microchip.com/SMPS)) for the latest updates to the code examples and for additional code examples.

# Digital Power Starter Kit User's Guide

---

---

NOTES:

**Appendix A. Board Layout and Schematics**

**FIGURE A-1: DIGITAL POWER STARTER KIT LAYOUT (TOP)**

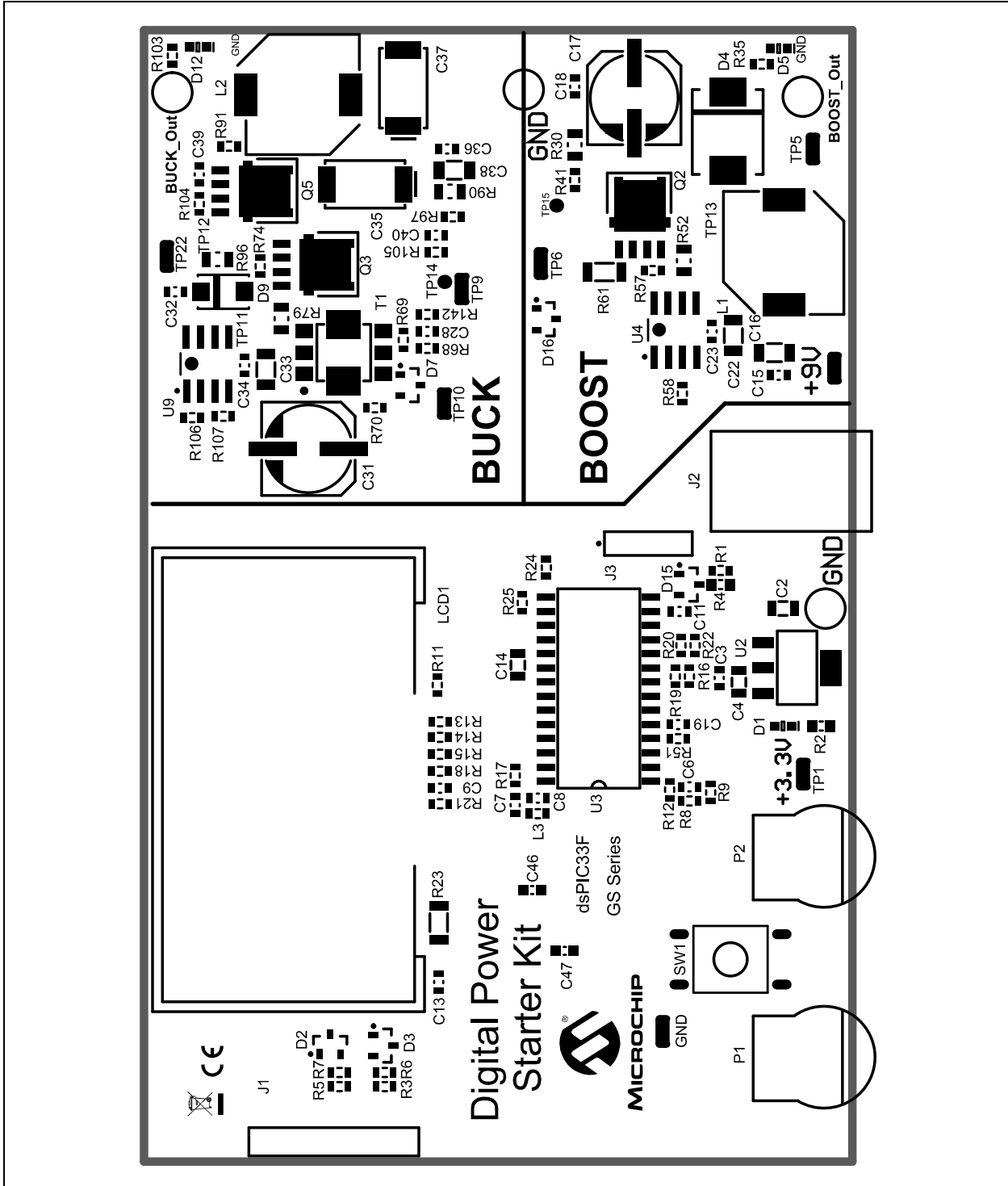

# Digital Power Starter Kit User's Guide

FIGURE A-2: DIGITAL POWER STARTER KIT LAYOUT (BOTTOM)

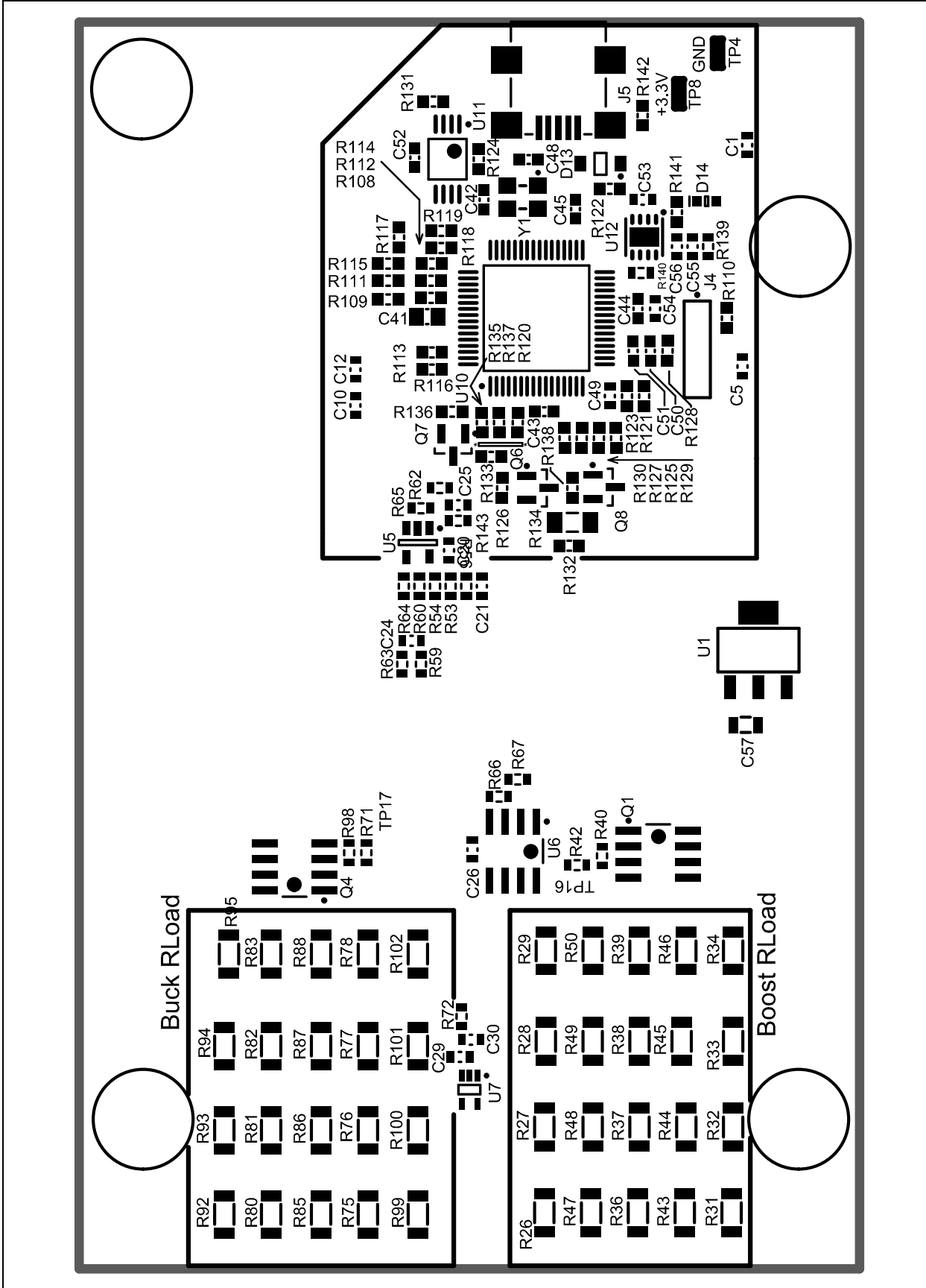



# Board Layout and Schematics

**FIGURE A-3: DIGITAL POWER STARTER KIT SCHEMATIC**

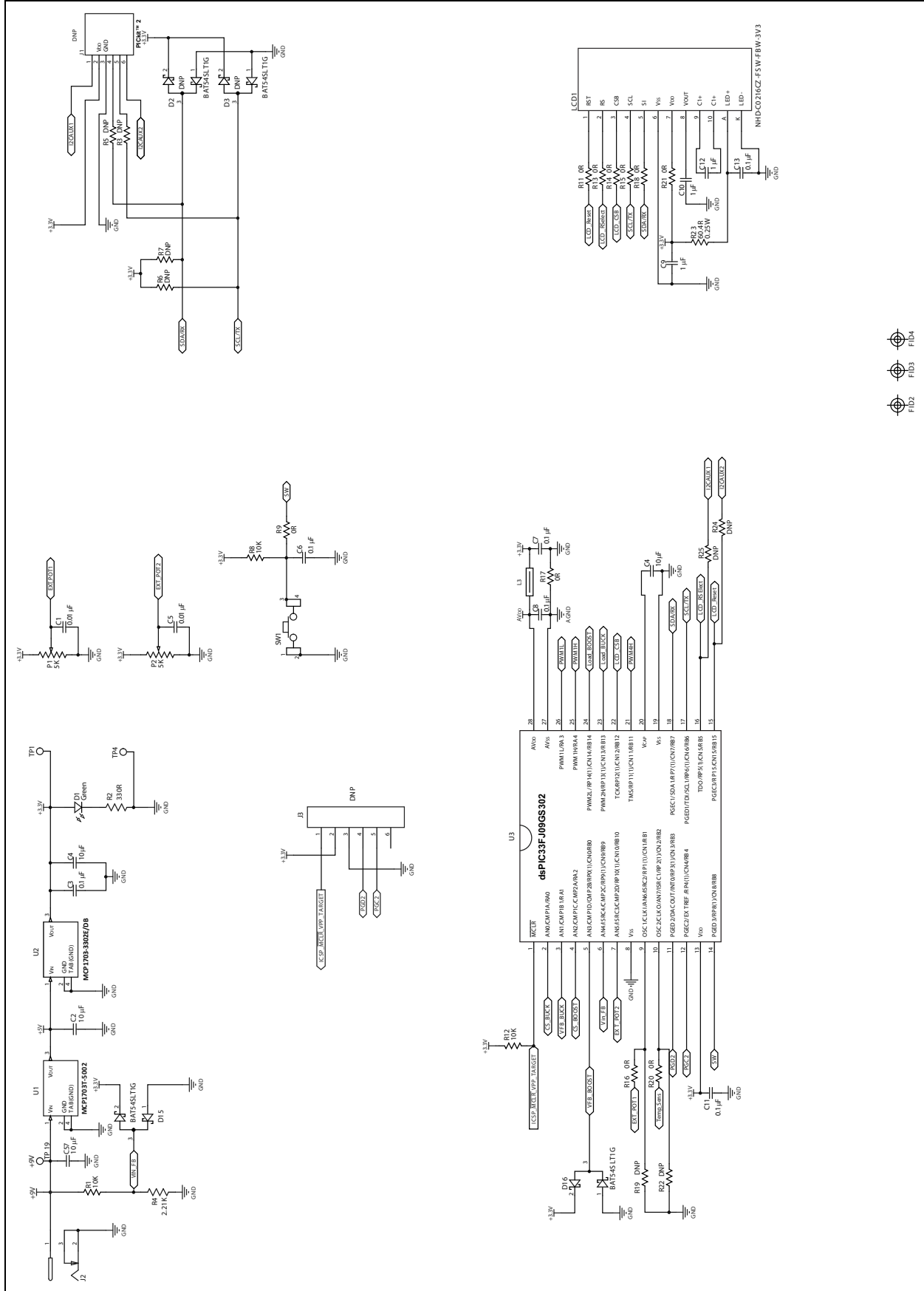

FID2  
FID3  
FID4

# Digital Power Starter Kit User's Guide

FIGURE A-4: DIGITAL POWER STARTER KIT SCHEMATIC (BOOST CONVERTER)

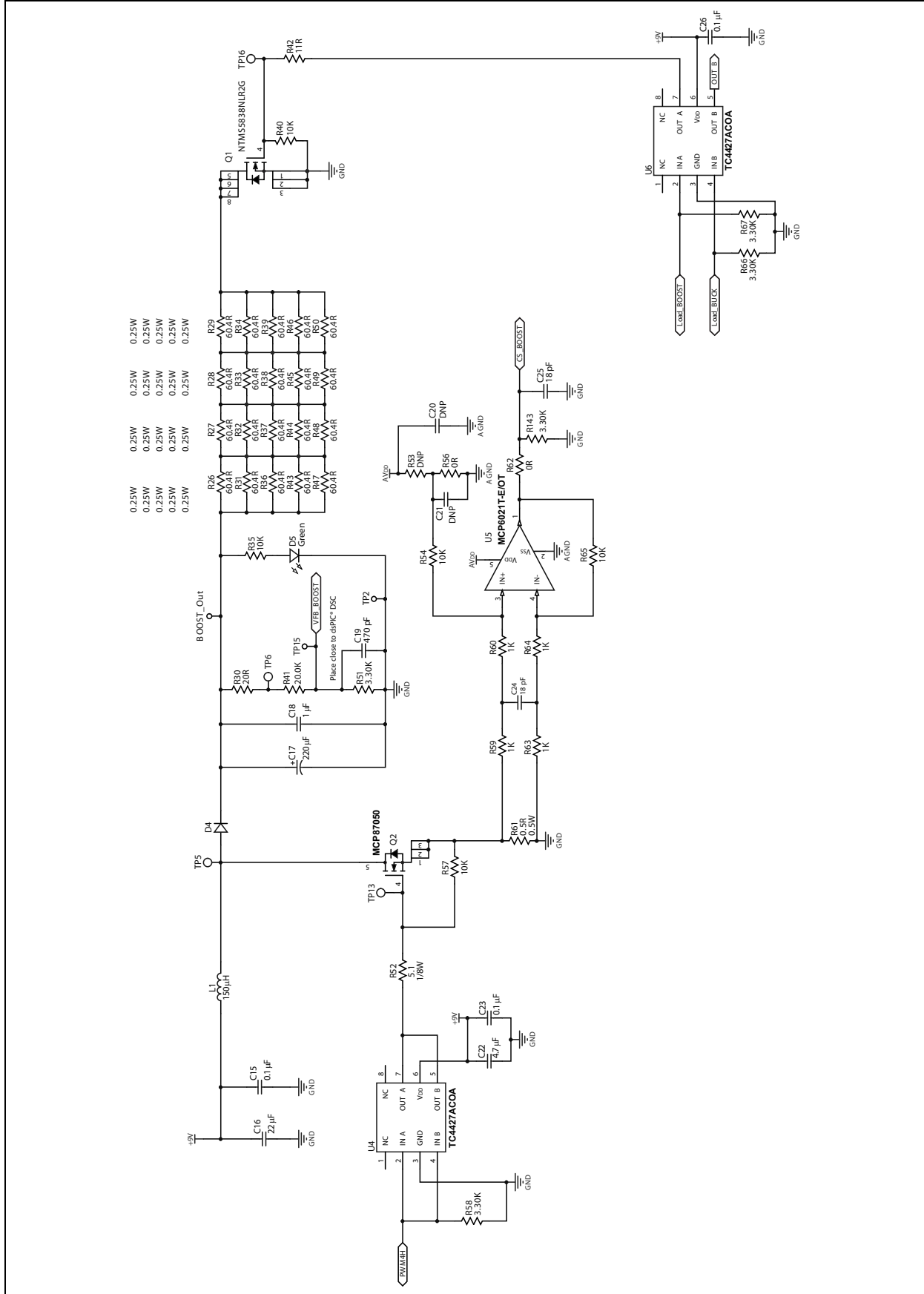

# Board Layout and Schematics

**FIGURE A-5: DIGITAL POWER STARTER KIT SCHEMATIC (BUCK CONVERTER)**

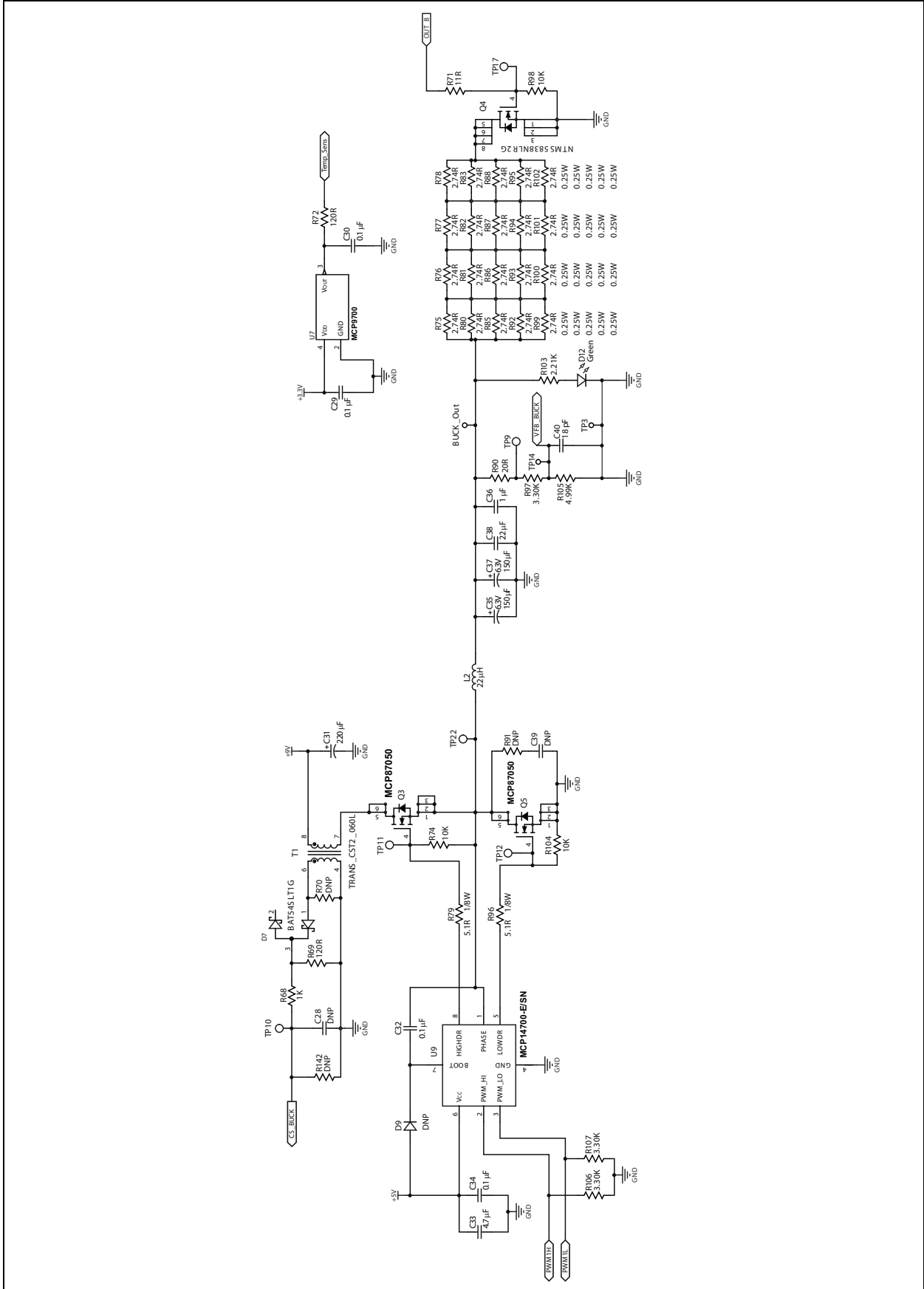

# Digital Power Starter Kit User's Guide

---

NOTES:

---

---

**NOTES:**



# MICROCHIP

## Worldwide Sales and Service

### AMERICAS

**Corporate Office**  
2355 West Chandler Blvd.  
Chandler, AZ 85224-6199  
Tel: 480-792-7200  
Fax: 480-792-7277  
Technical Support:  
<http://www.microchip.com/support>  
Web Address:  
[www.microchip.com](http://www.microchip.com)

**Atlanta**  
Duluth, GA  
Tel: 678-957-9614  
Fax: 678-957-1455

**Boston**  
Westborough, MA  
Tel: 774-760-0087  
Fax: 774-760-0088

**Chicago**  
Itasca, IL  
Tel: 630-285-0071  
Fax: 630-285-0075

**Cleveland**  
Independence, OH  
Tel: 216-447-0464  
Fax: 216-447-0643

**Dallas**  
Addison, TX  
Tel: 972-818-7423  
Fax: 972-818-2924

**Detroit**  
Farmington Hills, MI  
Tel: 248-538-2250  
Fax: 248-538-2260

**Indianapolis**  
Noblesville, IN  
Tel: 317-773-8323  
Fax: 317-773-5453

**Los Angeles**  
Mission Viejo, CA  
Tel: 949-462-9523  
Fax: 949-462-9608

**Santa Clara**  
Santa Clara, CA  
Tel: 408-961-6444  
Fax: 408-961-6445

**Toronto**  
Mississauga, Ontario,  
Canada  
Tel: 905-673-0699  
Fax: 905-673-6509

### ASIA/PACIFIC

**Asia Pacific Office**  
Suites 3707-14, 37th Floor  
Tower 6, The Gateway  
Harbour City, Kowloon  
Hong Kong  
Tel: 852-2401-1200  
Fax: 852-2401-3431

**Australia - Sydney**  
Tel: 61-2-9868-6733  
Fax: 61-2-9868-6755

**China - Beijing**  
Tel: 86-10-8569-7000  
Fax: 86-10-8528-2104

**China - Chengdu**  
Tel: 86-28-8665-5511  
Fax: 86-28-8665-7889

**China - Chongqing**  
Tel: 86-23-8980-9588  
Fax: 86-23-8980-9500

**China - Hangzhou**  
Tel: 86-571-2819-3187  
Fax: 86-571-2819-3189

**China - Hong Kong SAR**  
Tel: 852-2401-1200  
Fax: 852-2401-3431

**China - Nanjing**  
Tel: 86-25-8473-2460  
Fax: 86-25-8473-2470

**China - Qingdao**  
Tel: 86-532-8502-7355  
Fax: 86-532-8502-7205

**China - Shanghai**  
Tel: 86-21-5407-5533  
Fax: 86-21-5407-5066

**China - Shenyang**  
Tel: 86-24-2334-2829  
Fax: 86-24-2334-2393

**China - Shenzhen**  
Tel: 86-755-8203-2660  
Fax: 86-755-8203-1760

**China - Wuhan**  
Tel: 86-27-5980-5300  
Fax: 86-27-5980-5118

**China - Xian**  
Tel: 86-29-8833-7252  
Fax: 86-29-8833-7256

**China - Xiamen**  
Tel: 86-592-2388138  
Fax: 86-592-2388130

**China - Zhuhai**  
Tel: 86-756-3210040  
Fax: 86-756-3210049

### ASIA/PACIFIC

**India - Bangalore**  
Tel: 91-80-3090-4444  
Fax: 91-80-3090-4123

**India - New Delhi**  
Tel: 91-11-4160-8631  
Fax: 91-11-4160-8632

**India - Pune**  
Tel: 91-20-2566-1512  
Fax: 91-20-2566-1513

**Japan - Osaka**  
Tel: 81-66-152-7160  
Fax: 81-66-152-9310

**Japan - Yokohama**  
Tel: 81-45-471-6166  
Fax: 81-45-471-6122

**Korea - Daegu**  
Tel: 82-53-744-4301  
Fax: 82-53-744-4302

**Korea - Seoul**  
Tel: 82-2-554-7200  
Fax: 82-2-558-5932 or  
82-2-558-5934

**Malaysia - Kuala Lumpur**  
Tel: 60-3-6201-9857  
Fax: 60-3-6201-9859

**Malaysia - Penang**  
Tel: 60-4-227-8870  
Fax: 60-4-227-4068

**Philippines - Manila**  
Tel: 63-2-634-9065  
Fax: 63-2-634-9069

**Singapore**  
Tel: 65-6334-8870  
Fax: 65-6334-8850

**Taiwan - Hsin Chu**  
Tel: 886-3-5778-366  
Fax: 886-3-5770-955

**Taiwan - Kaohsiung**  
Tel: 886-7-536-4818  
Fax: 886-7-330-9305

**Taiwan - Taipei**  
Tel: 886-2-2500-6610  
Fax: 886-2-2508-0102

**Thailand - Bangkok**  
Tel: 66-2-694-1351  
Fax: 66-2-694-1350

### EUROPE

**Austria - Wels**  
Tel: 43-7242-2244-39  
Fax: 43-7242-2244-393

**Denmark - Copenhagen**  
Tel: 45-4450-2828  
Fax: 45-4485-2829

**France - Paris**  
Tel: 33-1-69-53-63-20  
Fax: 33-1-69-30-90-79

**Germany - Munich**  
Tel: 49-89-627-144-0  
Fax: 49-89-627-144-44

**Italy - Milan**  
Tel: 39-0331-742611  
Fax: 39-0331-466781

**Netherlands - Drunen**  
Tel: 31-416-690399  
Fax: 31-416-690340

**Spain - Madrid**  
Tel: 34-91-708-08-90  
Fax: 34-91-708-08-91

**UK - Wokingham**  
Tel: 44-118-921-5869  
Fax: 44-118-921-5820

11/29/11