

LOC		DIST		REVISIONS			
FT	60	REV	DATE	BY	CHK	APPV	
C1		REVISED PER ECO-11-004587	11MAR11	RK	HMR		

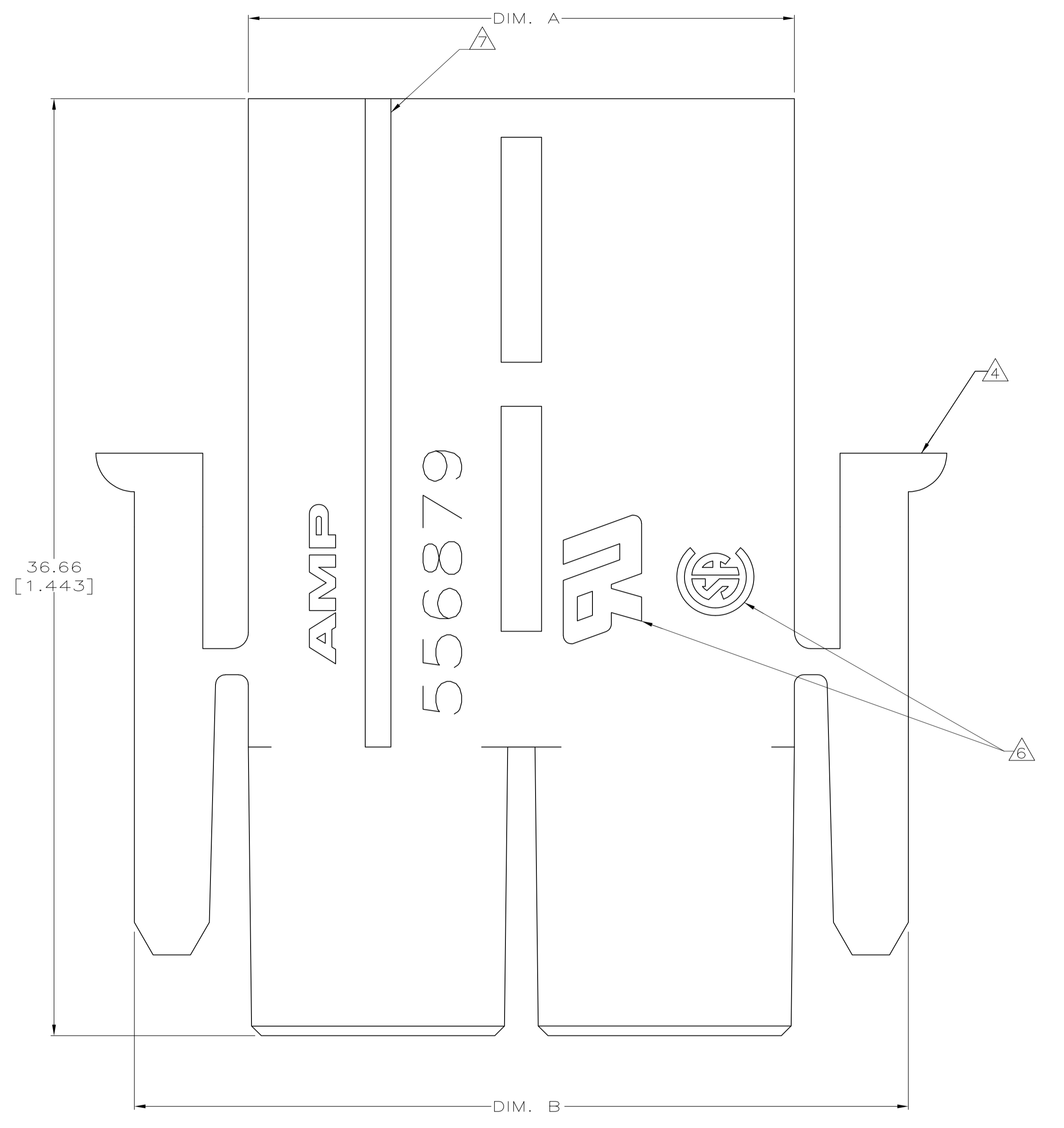

- 1 MATERIAL: POLYCARBONATE, BLACK, 94V-0.
- 2 ALL DIMENSIONS ARE MAXIMUM UNLESS OTHERWISE SPECIFIED.
- 3 POLARIZATION FEATURE TO MATING HOUSING.
- 4 POSITIVE LATCHING OF PLUG HOUSING TO RECEPTACLE HOUSING ASSEMBLY.
- 5. POSITION 1 IS DESIGNED FOR MAKE-FIRST/BREAK-LAST GROUND WHERE NEEDED.
- 6 THESE HOUSINGS ARE UL RECOGNIZED AND CSA CERTIFIED.
- INDICATES POSITION 1.

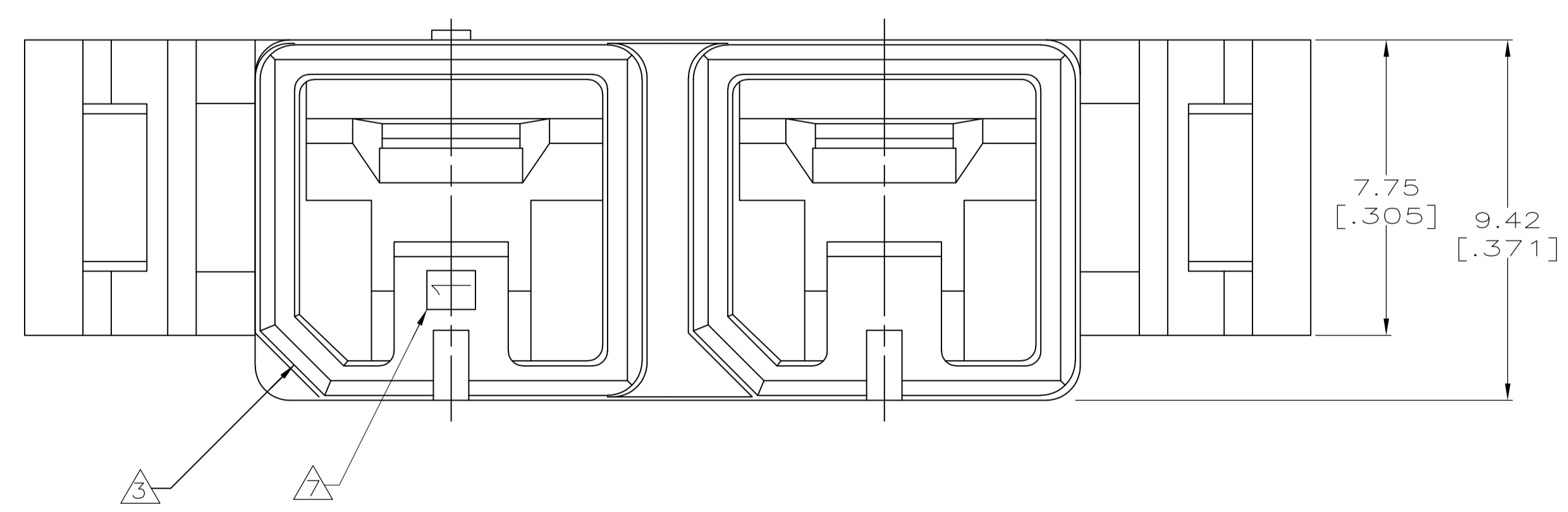

POSITION	DIM. B	DIM. A	PART NO
8	97.36 [3.833]	88.47 [3.483]	556879-8
7	86.19 [3.393]	77.30 [3.043]	-7
6	75.01 [2.953]	66.12 [2.603]	-6
5	63.83 [2.513]	54.94 [2.163]	-5
4	52.66 [2.073]	43.77 [1.723]	-4
3	41.48 [1.633]	32.59 [1.283]	-3
2	30.31 [1.193]	21.42 [.843]	556879-2

THIS DRAWING IS A CONTROLLED DOCUMENT.

DIMENSIONS: mm [INCHES]	TOLERANCES UNLESS OTHERWISE SPECIFIED:	DIN 5-30-91	NAME
0. PLC ± .01	1. PLC ± .01	8-23-91	STRAUSSER
2. PLC ± .01	3. PLC ± .01	8-26-91	FOX
4. PLC ± .01	ANGLES ± .1		MILLER
MATERIAL	FINISH	SIZE	CAGE CODE
		A1	00779
		WEIGHT	DRAWING NO
			556879
		CUSTOMER DRAWING	RESTRICTED TO
		SCALE 8:1	SHEET 1 OF 1
			REV C1

STE TE Connectivity
HOUSING, PLUG, WTB, AMPINNERGY™

Mouser Electronics

Authorized Distributor

Click to View Pricing, Inventory, Delivery & Lifecycle Information:

[TE Connectivity:](#)

[556879-8](#)