

M-Series

CIRCUIT BREAKER

The M-Series is a low cost, miniature, hydraulic-magnetic circuit breaker which features a compact, space saving design, front panel snap-in mounting and a vertically mounted parallel pole configuration. It features various styling options to maximize your design flexibility. Choices include rocker, illuminated rocker, paddle and baton style handle actuators, push-to-reset and push-pull pushbutton actuators, as well as Visi-Rocker two color actuators. Our exclusive Rockerguard bezel helps prevent inadvertent actuation and a wiping contact mechanism assures long-term reliability.

The M-Series circuit breakers are available with 1, 2 or parallel poles, 0.02 to 50 amp ratings, and 125 and 250VAC or 80VDC versions. With over 16 different time delays, 5 terminal styles, a variety of panel hardware, various colors, and legend imprinting, it assures suitability for most any application design.



Resources:

[Download 3D CAD Files](#)

[IGS >](#)

[STP >](#)

Product Highlights:

- Parallel pole configuration fits in one rack unit
- MIL-PRF-55629
- MIL STD 202 compliant
- MIL-PRF-39019F ingress protection
- Sealed toggle actuator
- Compact design

Typical Applications:

- Telecom/Datacom
- Transportation
- Marine
- Generators
- Power Supplies
- Medical Equipment



Carling Technologies®

Innovative Designs. Powerful Solutions.

Carling Technologies, Inc.

60 Johnson Avenue, Plainville, CT 06062

Email: sales@carlingtech.com

Application Support: team2@carlingtech.com

Phone: 860.793.9281 Fax: 860.793.9231

www.carlingtech.com

Electrical

Maximum Voltage 125/250 VAC 50/60 Hz, 80 VDC (See Rating Tables.)

Current Ratings Standard current coils: 0.100, 0.250, 0.500, 0.750, 1.00 thru 15.0 in 1 amp increments, 18.0, 20.0, 25.0, 30.0. Other ratings available - see Ordering Scheme.

Auxiliary Switch Rating SPDT; 7A 250VAC, 7A (Res) 28VDC, 4A (Ind.) 28VDC, 0.25A 80VDC (Res) (silver contacts), 0.1A 125VAC (gold contacts).

Insulation Resistance Minimum of 100 Megohms at 500 VDC.

Dielectric Strength UL, CSA 1500V, 50/60 Hz for one minute between all electrically isolated terminals. M-Series Circuit Breakers comply with the 8mm spacing and 3750 V 50/60Hz dielectric requirements from hazardous voltage to operator accessible surfaces, per Publications IEC 380, 435, 950, EN 60950 and VDE 0805.

Resistance, Impedance Values from Line to Load Terminal - based on Series Trip Circuit Breaker.

Mechanical

Endurance 10,000 ON-OFF operations @ 6 per minute with rated Current and Voltage.

Trip Free All M-Series Circuit Breakers will trip on overload, even when actuator is forcibly held in the ON position.

Trip Indication The actuator moves positively to the OFF position when an overload causes the circuit breaker to trip.

Physical

Number of Poles 1 or 2

Internal Circuit Configs. Series with or without Auxiliary Switch. Switch Only with or without Auxiliary Switch.

Weight Approximately 30 grams/pole (Approximately 1.07 ounces/pole)

Standard Colors See Ordering Scheme

Environmental

Designed in accordance with requirements of specification MIL PRF-55629 & MIL-STD-202G as follows:

Shock Withstands 100 Gs, 6ms, sawtooth while carrying rated current per Method 213, Cond. I. Instantaneous curves tested at 80% of rated current.

Vibration Withstands 0.060" excursion from 10-55 Hz, and 10 Gs 55-500 Hz, at rated current per Method 204C, Test Condition A. Instantaneous curves tested at 80% of rated current.

Moisture Resistance Method 106D, i.e., ten 24-hour cycles @ + 25°C to +65°C, 80-98% RH.

Salt Spray Method 101, Condition A (90-95% RH @ 5% NaCl Solution, 96 hrs).

Thermal Shock Method 107D, Condition A (Five cycles @ -55°C to +25°C to +85°C to +25°C).

Operating Temperature -40° C to +85° C

Chemical Resistance Only the outside surfaces of the case and the handles may be cleaned with detergents or alcohol. Organic (hydrocarbon based) solvents are not recommended because they attack plastics. Caution should be taken when solvents are used to clean and remove flux from terminals. Lubricants should not be introduced into the handle/ bushing openings

RESISTANCE PER POLE VALUES from Line to Load Terminals (Values Based on Series Trip Circuit Breaker)

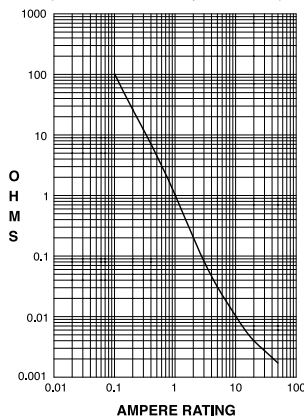

CURRENT (AMPS)	TOLERANCE (%)
0.10 - 20.0	± 25
20.1 - 50.0	± 35

Pulse Tolerance Curves

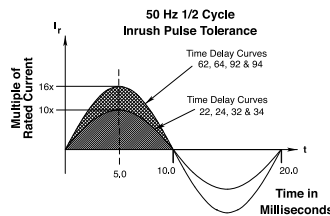
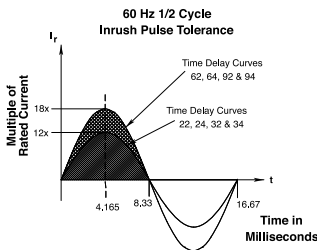

*Manufacturer reserves the right to change product specification without prior notice.

Electrical Tables

Table A: Lists UL Recognized and CSA Accepted configurations & performance capabilities as a Component Supplementary Protector.

M-SERIES TABLE A: COMPONENT SUPPLEMENTARY PROTECTORS										
Circuit Configuration	Voltage			Current Rating		Poles Breaking	Short Circuit Capacity (Amps)		Application Codes	
	Max Rating	Frequency	Phase	Full Load Amps	General Purpose Amps		UL / CSA		UL	CSA
							With Backup Fuse	Without Backup Fuse		
Series	32	DC	---	0.02 - 15	---	1	---	1000	TC1, 2, OL1, U1	TC1, 2, OL1, U1
				---	15.1 - 25	1	---	1000	TC1, 2, OL0, U1	TC1, 2, OL0, U1
	50 ²	DC	---	0.02 - 7.5	---	1	---	1000	TC1, 2, OL0, U1	TC1, 2, OL0, U1
				0.02 - 15	---	2	---	1000	TC1, 2, OL1, U1	TC1, 2, OL1, U1
	65	DC	---	---	15.1 - 25	2	---	1000	TC1, 2, OL0, U1	TC1, 2, OL0, U1
				0.02 - 15	---	1	---	1000	TC1, 2, OL1, U1	TC1, 2, OL1, U1
	65 ^{1,2}	DC	---	---	15.1 - 30	1	---	1000	TC1, 2, OL0, U1	TC1, 2, OL0, U1
				0.02 - 15	---	2	5000 ³	---	TC1, 2, OL1, C1	TC1, 2, OL1, C1
	65	DC	---	---	15.1 - 25	2	5000 ³	---	TC1, 2, OL0, C1	TC1, 2, OL0, C1
				0.02 - 15	---	1	---	600	TC1, 2, OL1, U1	TC1, 2, OL1, U1
	80 ¹	DC	---	---	15.1 - 30	1	---	600	TC1, 2, OL0, U1	TC1, 2, OL0, U1
				0.02 - 15	---	1	---	1000	TC1, 2, OL1, U1	TC1, 2, OL1, U1
	125	50 / 60	1	0.02 - 15	---	1	---	1000	TC1, 2, OL1, U1	TC1, 2, OL1, U1
				---	15.1 - 30	1	---	1000	TC1, 2, OL0, U1	TC1, 2, OL0, U1
1 - 30				---	1	---	360	TC1, OL1, U2	TC3, OL1, U3	
250 ²	50 / 60	1	0.02 - 12	---	1	---	1000	TC1, 2, OL1, U1	TC1, 2, OL1, U1	
250	50 / 60	1	---	12.1 - 18	1	1000 ⁴	---	TC1, 2, OL0, C1	TC1, 2, OL0, C1	
250	50 / 60	1	0.02 - 15	---	2	---	1000	TC1, 2, OL1, U1	TC1, 2, OL1, U1	
			---	15.1 - 30	2	---	1000	TC1, 2, OL0, U1	TC1, 2, OL0, U1	
			1 - 30	---	2	---	360	TC1, OL1, U2	TC3, OL1, U3	

Notes:

- 1 Polarity Sensitive
- 2 Available only with Special Catalog Number. Consult Factory.
- 3 Requires Branch Circuit Backup with a UL Listed type K-5 or RK-5 fuse rated 30 Amps maximum
- 4 Requires Branch Circuit Backup with a UL Listed type K-5 or RK-5 fuse rated 60 Amps maximum

Table B: Lists UL Recognized, CSA Accepted and TUV and VDE Certified configurations and performance capabilities as a Component Supplementary Protector.

M-SERIES TABLE B: COMPONENT SUPPLEMENTARY PROTECTORS												
Circuit Configuration	Voltage			Current Rating		Poles Breaking	Short Circuit Capacity (Amps)				Application Codes	
	Max Rating	Frequency	Phase	Full Load Amps	General Purpose Amps		UL / CSA		VDE / TUV		UL	CSA
							With Backup Fuse	Without Backup Fuse	With Backup Fuse	Without Backup Fuse		
Series	32	DC	---	0.02 - 15	---	1	---	1000	3000	500	TC1, 2, OL1, U1	TC1, 2, OL1, U1
				---	15.1 - 25	1	---	1000	3000	500	TC1, 2, OL0, U1	TC1, 2, OL0, U1
	50 ²	DC	---	0.02 - 7.5	---	1	---	1000	3000	500	TC1, 2, OL0, U1	TC1, 2, OL0, U1
				0.02 - 15	---	2	---	1000	3000	500	TC1, 2, OL1, U1	TC1, 2, OL1, U1
	65	DC	---	---	15.1 - 25	2	---	1000	3000	500	TC1, 2, OL0, U1	TC1, 2, OL0, U1
				0.02 - 15	---	2	5000	---	3000	500	TC1, 2, OL1, C1	TC1, 2, OL1, C1
	65 ³	DC	---	---	15.1 - 30	2	5000	---	3000	500	TC1, 2, OL0, C1	TC1, 2, OL0, C1
				0.02 - 15	---	1	---	600 ⁴	---	500	TC1, 2, OL1, U1	TC1, 2, OL1, U1
	80 ¹	DC	---	---	15.1 - 30	1	---	600 ⁴	---	500	TC1, 2, OL0, U1	TC1, 2, OL0, U1
				0.02 - 15	---	1	---	1000	3000	500	TC1, 2, OL1, U1	TC1, 2, OL1, U1
	125	50 / 60	1	0.02 - 15	---	1	---	360	3000	500	TC1, OL1, U2	TC3, OL1, U3
				1 - 15	---	1	---	1000	3000	500	TC1, 2, OL1, U1	TC1, 2, OL1, U1
	250	50 / 60	1	0.02 - 12	---	1	---	1000	3000	500	TC1, 2, OL1, U1	TC1, 2, OL1, U1
				0.02 - 20	---	2	---	1000	3000	500	TC1, 2, OL0, U1	TC1, 2, OL0, U1
1 - 12				---	1	---	360	3000	500	TC1, OL1, U2	TC3, OL1, U3	

Notes:

- 1 Polarity Sensitive
- 2 Available only with Special Catalog Number. Consult Factory.
- 3 Requires Branch Circuit Backup with a UL Listed type K-5 or RK-5 fuse rated 30 Amps maximum
- 4 TUV only, not VDE
- 5 Requires backup protection with a thermal magnetic circuit breaker rated 32 amps and having a Type C trip characteristic per EN60898/DIN VDE 0641 (C32A) for ratings greater than 15amps, and a thermal magnetic circuit breaker rated 16 amps and having a Type C trip characteristic per EN60898/DIN VDE 0641 (C16A) for ratings 15 amps and less

Electrical Tables

Table C: Lists UL489A Listed and TUV Certified configurations and performance capabilities for use in Communications Equipment.

M-SERIES TABLE C: UL489A Listed (Communications Equipment - Polarity Sensitive)						
Circuit Configuration	Voltage		Current Rating General Purpose Amps	Poles Breaking	Interrupting Capacity (Amps)	
	Max Rating	Frequency			Without Backup Fuse	
					UL489A	TUV
Series	80	DC	0.02 - 30	1	600	---
	65 ¹	DC	0.02 - 30	1	1000	---
	80	DC	0.10 - 30	1	600	600

Notes:

1. Available only with Special Catalog Number

Table D: Lists UL489A Listed configurations and performance capabilities for use in Communications Equipment.

M-SERIES TABLE D: Parallel Pole Construction UL489A Listed (Communications Equipment - Polarity Sensitive)						
Circuit Configuration	Voltage		Current Rating General Purpose Amps	Poles Breaking	Interrupting Capacity (Amps)	
	Max Rating	Frequency			Without Backup Fuse	
					UL489A	
Series	80	DC	31 - 50	2	600	
	65 ¹	DC	31 - 50	2	1000	

Notes:

1. Available only with Special Catalog Number

Agency Certifications

UL Recognized

UL Standard 1077



Component Recognition Program as Protectors, Supplementary (Guide CCN/QVNU2, File E75596)

CSA Accepted



Component Supplementary Protector (Class 3215 30, File 047848 0 000) CSA Standard C22.2 No. 235

UL Listed

UL Standard 489A



Communications Equipment (Guide CCN/DITT, File E189195)

VDE Certified



EN60934, VDE 0642 under File 10537

TUV Certified



EN60934, under License No. R9671109

M **E** **2** - **P** - **D2** - **650** - **5** - **A** **1** **2** - **B** - **T**

1 Series 2 Actuator 3 Poles 4 Circuit 5 Frequency & Delay 6 Current Rating 7 Terminal 8 Illumination 9 Actuator Color & Legend 10 Legend 11 Bezel Color 12 Agency Approval

1 SERIES
M

2 ACTUATOR

Single Color
A Angled
B Flat

Two Color Visi
D Indicate ON
E Indicate OFF

Single Color Translucent
F Angled
G Flat

STYLE	INDICATE - "ON" (CODE-D)	INDICATE - "OFF" (CODE-E)	FLAT (CODES-B & G)	ANGLED (CODES-A & F)
VERTICAL				
HORIZONTAL				

3 POLES
2 Two

4 CIRCUIT/AUXILIARY SWITCH ²
P Series Trip Current (Parallel Pole)
with Auxiliary Switch, Silver Contacts
Q Series Trip Current (Parallel Pole) .110 x 0.20 Q.C
with Auxiliary Switch, Gold Contacts
R Series Trip Current (Parallel Pole) .110 x 0.20 Q.C

5 FREQUENCY & TIME DELAY
D2 DC Short
D4 DC Medium

6 CURRENT RATING (AMPERES)

CODE	AMPERES
631	31.000
635	35.000
640	40.000
645	45.000
650	50.000

7 TERMINAL
A Push in Stud
5 10-32 Screw (Bus Type)

8 ILLUMINATION
Non-Illuminated
A Non-Illuminated

9 ACTUATOR COLOR & LEGEND

	Actuator Visi ¹	Legend
1	White	Black
2	Black	White
3	Red	White
4	Green	White
5	Blue	White
6	Yellow	Black
7	Gray	Black
8	Orange	Black

10 LEGEND
2 ON - OFF Vertical
3 ON - OFF Horizontal
6 Dual Vertical
7 Dual Horizontal

11 BEZEL COLOR
A White without Rockerguard
B Black without Rockerguard
G Gray without Rockerguard
1 White with Rockerguard
2 Black with Rockerguard
7 Gray with Rockerguard

12 AGENCY APPROVAL
T UL 489A Listed

Notes:
 1 Reminder of Rocker same color as Visi
 2 Aux Switch only available with screw terminals



1 SERIES
M

2 ACTUATOR
M Paddle
T Push-Pull

3 POLES
2 Two

4 CIRCUIT/AUXILIARY SWITCH ¹
P Series Trip Current (Parallel Pole)
with Auxiliary Switch, Silver Contacts
Q Series Trip Current (Parallel Pole) .110 x 0.20 Q.C
with Auxiliary Switch, Gold Contacts
R Series Trip Current (Parallel Pole) .110 x 0.20 Q.C

5 FREQUENCY & TIME DELAY
D2 DC Short
D4 DC Medium

6 CURRENT RATING (AMPERES)

CODE	AMPERES
631	31.000
635	35.000
640	40.000
645	45.000
650	50.000

7 TERMINAL
A Push in Stud
5 10-32 Screw (Bus Type)

8 ACTUATOR COLOR & LEGEND

Handle		Push Button	
1	White	A	White
2	Black	B	Black
3	Red	C	Red
4	Green	D	Green
5	Blue	E	Blue
6	Yellow	F	Yellow
7	Gray	G	Gray
8	Orange	H	Orange

9 FRONT PANEL HARDWARE

Handle

- A No outer Panel Hardware
- B Knurled Nut, Bright Nickel
- C Knurled Nut, Bright Nickel with Locking Ring
- D Knurled Nut, Black
- E Knurled Nut, Black with Locking Ring
- F Panel Dress, Bright Nickel
- G Panel Dress, Bright Nickel with Locking Ring
- H Panel Dress, Black
- J Panel Dress, Black with Locking Ring

Push Button

- 1 No outer Panel Hardware
- 2 Knurled Nut, Bright Nickel

10 LEGEND PLATE / BUTTON MARKING

Handle Actuator Legend Plate

- B ON - OFF Vertical
- C ON - OFF Horizontal

Push-Pull Actuator Legend Plate

- 2 Rated Amps Horizontal
- 3 Rated Amps Line Side Down
- 4 Rated Amps Line Side Up

11 BUSHING COLOR
B Black

12 AGENCY APPROVAL
T UL 489A Listed

Notes:
 1 Aux Switch only available with screw terminals

Dimensional Specifications: in. [mm]

PARALLEL POLE TERMINAL OPTIONS

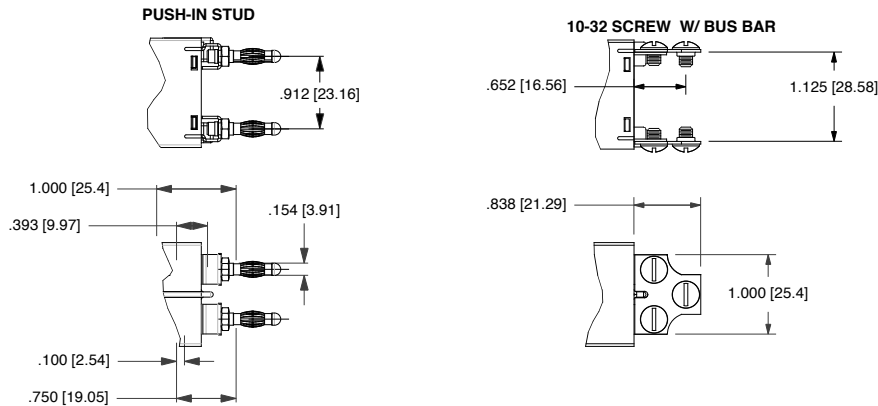

ROCKER ACTUATOR DETAIL

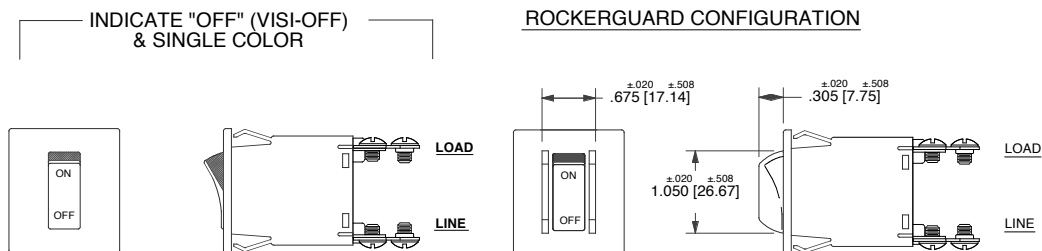
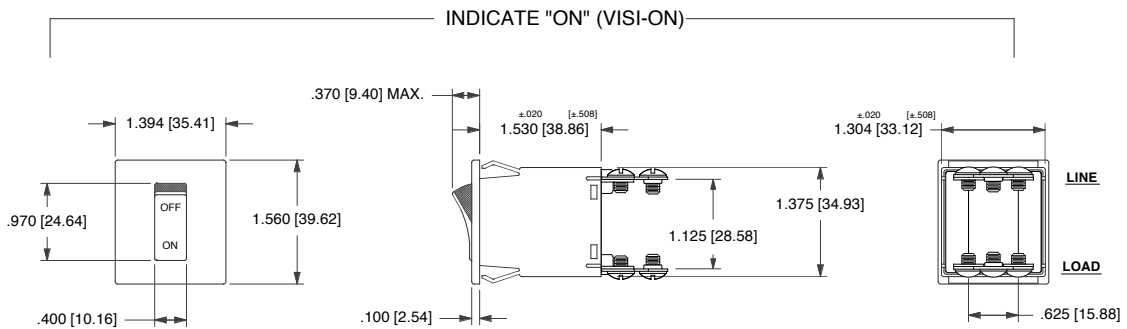

PANEL CUT - OUT DETAIL (ROCKER)

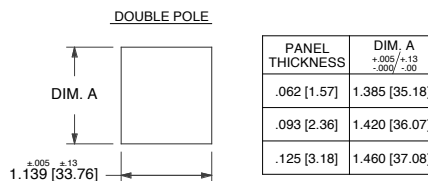

Notes:

- 1 All dimensions are in inches [millimeters].
- 2 Tolerance ±.010 [.25] unless otherwise specified.
- 3 Dimensions apply to both rocker styles.
- 4 I-o, on-off or dual legends available for vertical or horizontal mounting.
- 5 Notice that circuit breaker line and load terminal orientation on indicate "off" is opposite that of indicate "on".

Dimensional Specifications: in. [mm]

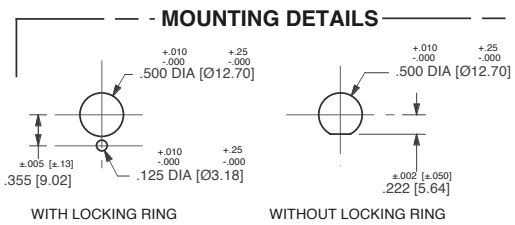
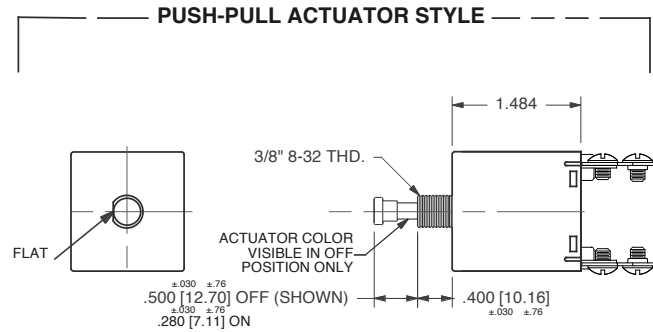
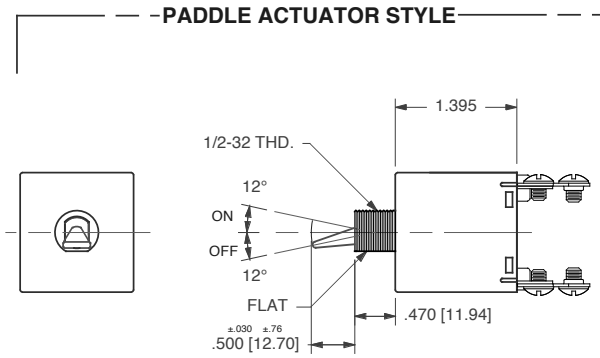

MOUNTING DETAILS

PANEL HARDWARE

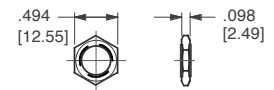
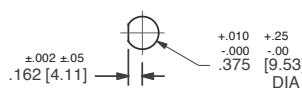

PUSH-PULL, PUSH TO RESET

HEX NUT

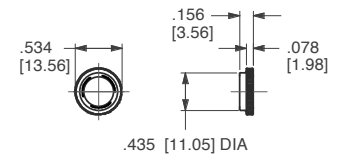
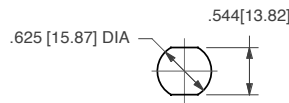

SNAP-IN BUSHING

PANEL DRESS NUT

LEGEND PLATES

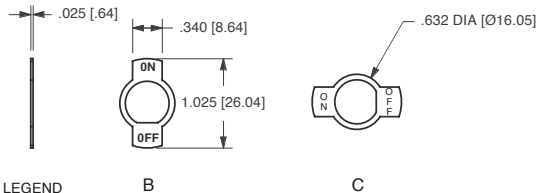

LEGEND CODE:

B

C

BUTTON MARKING ORIENTATION

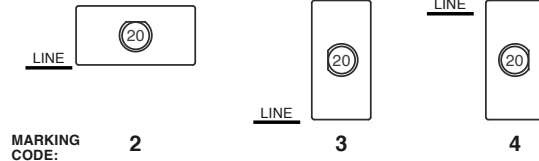

MARKING CODE:

PANEL HARDWARE

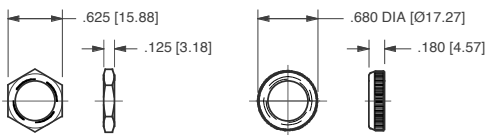

HEX NUT

PANEL DRESS NUT

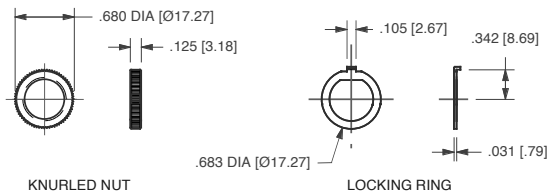

KNURLED NUT

LOCKING RING

.110QC AUXILIARY SWITCH TERMINALS

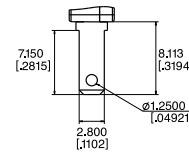



Notes:



- 1 All dimensions are in inches [millimeters].
- 2 Tolerance ±.010 [.25] unless otherwise specified.
- 3 Dimensions apply to both rocker styles.
- 4 I-o, on-off or dual legends available for vertical or horizontal mounting.
- 5 Notice that circuit breaker line and load terminal orientation on indicate "off" is opposite that of indicate "on".



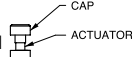

1 SERIES
M

2 ACTUATOR ¹

Handle
M Paddle  N Baton 

Push Button
T Push-Pull  U Push To Reset 

Push Button with Snap-In Mounting
V Push-Pull  W Push To Reset 

3 POLES
1 One 2 Two

4 CIRCUIT ²
without Auxiliary Switch
A Switch Only (no coil), Maintained Contacts
B Series Trip (Current)
with Auxiliary Switch, Silver Contacts
M Series Trip (Current) Aux Switch
P³ Switch Only, Maintained Contacts
Q^{3,4} Switch Only, Maintained Contacts
R^{3,13} Switch Only, Maintained Contacts
S³ Series Trip (Current)
T^{3,4} Series Trip (Current)
U^{3,13} Series Trip, Maintained Contacts
with Auxiliary Switch, Gold Contacts
2^{3,4} Switch Only, Maintained Contacts
3^{3,13} Switch Only, Maintained Contacts
4^{3,4} Series Trip (Current)
5^{3,13} Series Trip, Maintained Contacts
9 Series Trip (Current) Aux Switch

Terminal Type:
.110 QC x .020 QC
.060 Dia, Round Solder Turret
.058 Dia, Round Q.C.
.080 Dia x .020 Flat Q.C.
.060 Dia, Round Solder Turret
.058 Dia, Round Q.C.
.080 Dia x .020 Flat Q.C.
.058 Dia, Round Q.C.
.080 Dia x .020 Flat Q.C.
.058 Dia, Round Q.C.
.080 Dia x .020 Flat Q.C.
.110 QC x .020 QC

5 FREQUENCY & DELAY

03	DC	50/60Hz	Switch Only	32	DC, 50/60Hz	Short
10	DC	Instantaneous		34	DC, 50/60Hz	Medium
12	DC	Short		62	50/60Hz	Short, Hi-Inrush
14	DC	Medium		64	50/60Hz	Medium, Hi-Inrush
20	50/60Hz	Instantaneous		72	DC, Short, Hi-Inrush	
22	50/60Hz	Short		74	DC, Medium, Hi-Inrush	
24	50/60Hz	Medium		92	DC, 50/60Hz	Short, Hi-Inrush
30	DC, 50/60Hz	Instantaneous		94	DC, 50/60Hz	Medium, Hi-Inrush

Voltage			Full Load Amp Rating		General Purpose Amps		Tungsten Lamp Rating		Poles Breaking
Max Rating	Frequency	Phase	Max Amps	Choose Current Coil Rating Code	Max Amps	Choose Current Coil Rating Code	Max Amps	Choose Current Coil Rating Code	
32	DC	-	15	615	25	625	-	-	1
50	DC	-	-	-	7.5	Consult Factory	-	-	1
65	DC	1	15	615	25	625	-	-	2
125	50/60Hz	1	15	615	25	625	15	615	1
250	50/60Hz	1	12	612	-	-	-	-	1
250	50/60Hz	1	15	615	25	625	-	-	2

- Notes:
- One actuator is located in the center of each multi-pole breaker. Actuator codes V & W limited to single pole breakers only.
 - Switch Only circuits are not available with Push-To-Reset actuators. For Switch Only circuits, select Current Coil Rating from the above chart.
 - One Auxiliary Switch is supplied per breaker. On two-pole breakers, standard Auxiliary Switch mounting is in pole one. Auxiliary Switch option limited to Series Trip and Switch Only circuits. Not available with back connect screw or push-in stud terminals.
 - Mates with AMP .058" diameter pin receptacles including 60983-1 (gold plated) and 60983-2 (tin plated).
 - Actuator color is only visible in the OFF position on Push-Pull actuators.
 - All units except snap-in mounting have one hex nut installed on bushing for use behind the panel.
 - Other colors available. Consult factory.
 - TUV 20A, VDE 15A. UL Recognized and CSA Accepted to 30 amps. Screw Terminals or Push-in Stud recommended above 20 amps.
 - 30 amp rating not available with delay's 30, 32, 34, 92 or 94.
 - Screw Terminals are VDE certified only with use of ring terminal attached to wire.
 - Terminal code A available with circuit codes A & B only.
 - Printed circuit board available with UL recognized approval only.
 - Auxiliary switch (flat Q.C.) available with UL recognized approvals only.

6 CURRENT RATING (AMPERES)

CODE	AMPERES						
020	0.020	225	0.250	420	2.000	710	10.500
025	0.025	230	0.300	522	2.250	611	11.000
030	0.030	235	0.350	425	2.500	711	11.500
035	0.035	240	0.400	527	2.750	612	12.000
040	0.040	245	0.450	430	3.000	712	12.500
045	0.045	250	0.500	435	3.500	613	13.000
050	0.050	255	0.550	440	4.000	614	14.000
055	0.055	260	0.600	445	4.500	615	15.000
060	0.060	265	0.650	450	5.000	616	16.000
065	0.065	270	0.700	455	5.500	617	17.000
070	0.070	275	0.750	460	6.000	618	18.000
075	0.075	280	0.800	465	6.500	620	20.000
080	0.080	285	0.850	470	7.000	622	22.000
085	0.085	290	0.900	475	7.500	624	24.000
090	0.090	295	0.950	480	8.000	625	25.000
090	0.095	410	1.000	485	8.500	630	30.000 ⁹
210	0.100	512	1.250	490	9.000		
215	0.150	415	1.500	495	9.500		
220	0.200	517	1.750	610	10.000		

7 TERMINAL

1	Push-On 0.250 Tab (Q.C.)	A ¹¹	Push-In Stud
2 ¹⁰	Screw 8-32 with Upturned Lugs	P ¹²	Printed Circuit Board
3 ¹⁰	Screw 8-32 (Bus Type)		

8 ACTUATOR COLOR & LEGEND ⁵

Gloss Handle	Push-Button	Actuator Color
1	A	White
2	B	Black
3	C	Red
4	D	Green
5	E	Blue
6	F	Yellow
8	H	Orange

9 FRONT PANEL HARDWARE ⁶

	Handle	Push-Button
No outer Panel Hardware	A	1
Knurled Nut		
Bright nickel	B	2
Bright nickel with locking ring	C	
Black	D	
Black with locking ring	E	
Panel Dress Nut		
Bright nickel	F	
Bright nickel with locking ring	G	
Black	H	
Black with locking ring	J	

10 LEGEND PLATE / BUTTON MARKING

Handle Actuator Legend Plate (Actuator Styles M & N)

- A No Legend Plate
- B ON - OFF Vertical
- C ON - OFF Horizontal
- D I - O Vertical
- E I - O Horizontal

Push-Pull Actuator Button Cap (Actuator Styles T & V)

- 1 No Marking
- 2 Rated Amps Horizontal
- 3 Rated Amps Line Side Down
- 4 Rated Amps Line Side Up

Push-to-Reset Actuator Button (Actuator Styles U & W)

- 1 No Marking

11 BUSHING COLOR ⁷
B Black



12 AGENCY APPROVAL ⁸

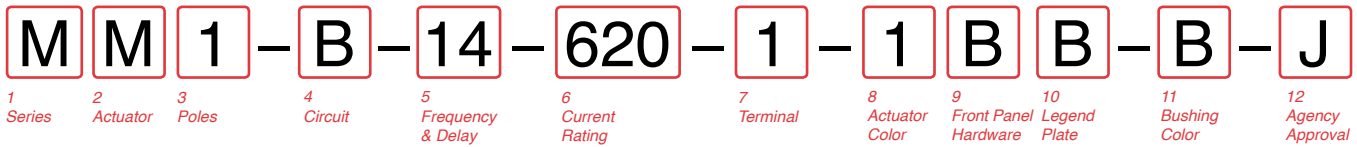

- C UL Recognized & CSA Accepted
- D VDE Certified, UL Recognized & CSA Accepted
- E TUV Certified, UL Recognized & CSA Accepted





1 SERIES
M

2 ACTUATOR ¹

Handle
M Paddle  N Baton 

Push Button
T Push-Pull  U ⁸ Push To Reset 

Push Button with Snap-In Mounting
V Push-Pull  W ⁸ Push To Reset 

3 POLES
1 One

4 CIRCUIT

without Auxiliary Switch
B Series Trip (Current)

with Auxiliary Switch, Silver Contacts
M Series Trip (Current) Aux Switch
S ³ Series Trip (Current)
T ^{3,4} Series Trip (Current)
U ^{3,13} Series Trip, Maintained Contacts

Terminal Type:
.110 QC x .020 QC
.060 Dia, Round Solder Turret
.058 Dia, Round Q.C.
.080 Dia x .020 Flat Q.C.

with Auxiliary Switch, Gold Contacts
4 ^{2,3} Series Trip (Current) .058 Dia, Round Q.C.
5 ^{3,12} Series Trip, Maintained Contacts .080 Dia x .020 Flat Q.C.
9 Series Trip (Current) Aux Switch .110 QC x .020 QC

5 FREQUENCY & DELAY

10 DC Instantaneous	72 DC, Short, Hi-Inrush
12 DC Short	74 DC, Medium, Hi-Inrush
14 DC Medium	

6 CURRENT RATING (AMPERES)

CODE	AMPERES				
020	0.020	225	0.250	420	2.000
025	0.025	230	0.300	522	2.250
030	0.030	235	0.350	425	2.500
035	0.035	240	0.400	527	2.750
040	0.040	245	0.450	430	3.000
045	0.045	250	0.500	435	3.500
050	0.050	255	0.550	440	4.000
055	0.055	260	0.600	445	4.500
060	0.060	265	0.650	450	5.000
065	0.065	270	0.700	455	5.500
070	0.070	275	0.750	460	6.000
075	0.075	280	0.800	465	6.500
080	0.080	285	0.850	470	7.000
085	0.085	290	0.900	475	7.500
090	0.090	295	0.950	480	8.000
090	0.095	410	1.000	485	8.500
210	0.100	512	1.250	490	9.000
215	0.150	415	1.500	495	9.500
220	0.200	517	1.750	610	10.000

7 TERMINAL ⁴

1 Push-On 0.250 Tab (Q.C.)	A ¹⁰ Push-In Stud
2 Screw 8-32 with Upturned Lugs	P ¹¹ Printed Circuit Board
3 Screw 8-32 (Bus Type)	

8 ACTUATOR COLOR & LEGEND ⁵

Gloss Handle	Push-Button	Actuator Color
1	A	White
2	B	Black
3	C	Red
4	D	Green
5	E	Blue
6	F	Yellow
8	H	Orange

9 FRONT PANEL HARDWARE ⁶

No outer Panel Hardware	Handle	Push-Button
Knurled Nut	A	1
Bright nickel	B	2
Bright nickel with locking ring	C	
Black	D	
Black with locking ring	E	
Panel Dress Nut	F	
Bright nickel	G	
Bright nickel with locking ring	H	
Black	J	
Black with locking ring		

10 LEGEND PLATE / BUTTON MARKING

Handle Actuator Legend Plate (Actuator Styles M & N)

A No Legend Plate
B ON - OFF Vertical
C ON - OFF Horizontal
D I - O Vertical
E I - O Horizontal

Push-Pull Actuator Button Cap (Actuator Styles T & V)

1 ⁸ No Marking
2 Rated Amps Horizontal
3 Rated Amps Line Side Down
4 Rated Amps Line Side Up

Push-to-Reset Actuator Button (Actuator Styles U & W)

1 ⁸ No Marking

11 BUSHING COLOR ⁷

B Black

12 AGENCY APPROVAL ⁹

J UL489A Listed, TUV Certified
M UL Recognized, CSA Accepted
N UL Recognized, TUV Certified
T UL489A Listed

1 One actuator is located in the center of each multi-pole breaker. Actuator codes V & W limited to single pole breakers only.
2 One Auxiliary Switch is supplied per breaker. On two-pole breakers, standard Auxiliary Switch mounting is in pole one. Auxiliary Switch option limited to Series Trip and Switch Only circuits. Not available with Back Connected Screw or Push-in Stud terminals.
3 Mates with AMP .058" diameter pin receptacles including 60983-1 (gold plated) and 60983-3 (tin plated).
4 Screw terminals or Push-in Stud recommended above 20 amps.
5 Actuator color is only visible in the OFF position on Push-Pull actuators.
6 All units have one hex nut installed on bushing for use behind the panel.
7 Other colors available. Consult factory.
8 Not available with UL489A Listed breakers.
9 UL Recognized, CSA Accepted and UL Listed to 30 amps.
10 Terminal code A available with circuit codes A & B only.
11 Printed circuit board available with UL recognized approval only.
12 Auxiliary switch (flat Q.C.) available with UL recognized approvals only.

Circuit & Terminal Diagrams: in. [mm]

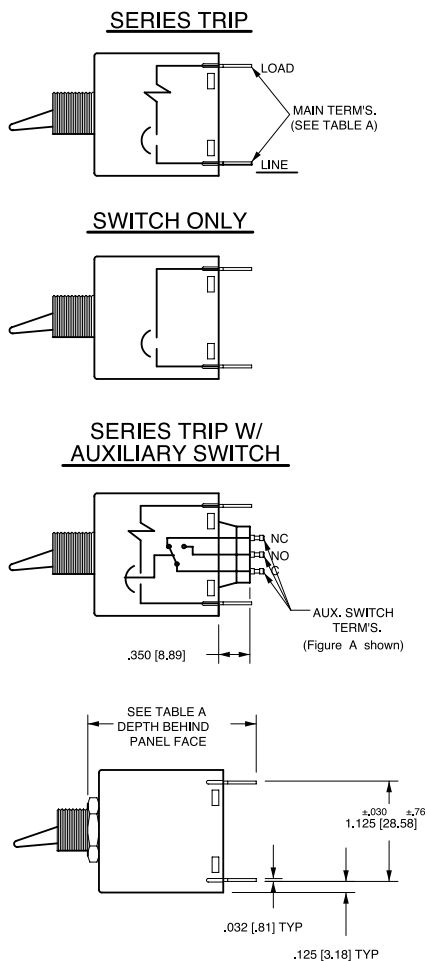

TERMINAL DESCRIPTION		DEPTH BEHIND PANEL FACE *
MAIN	TAB (Q.C)	1.890 [48.00]
	SCREW (#8-32)	1.930 [49.03]
	PUSH-IN STUD	2.520 [64.00]
AUX. ** SWITCH	DOUBLE SOLDER TURRET TYPE	2.035 [51.68]
	ROUND Q.C TYPE	2.025 [51.44]
	FLAT QUICK-CONNECT FLAT SOLDER LUG	2.129 [54.08] 2.012 [51.10]

*DEPTH INCLUDES BEHIND PANEL HEX NUT AS SUPPLIED ON ALL UNITS.

** WHEN CALLED FOR ON MULTI-POLE UNITS, ONLY ONE AUX. SWITCH IS NORMALLY SUPPLIED, MOUNTED AS SHOWN IN FIG. A

MULTI-POLE IDENTIFICATION SCHEME

SOLDER TURRET AND ROUND QC AUX SWITCH TERMINALS

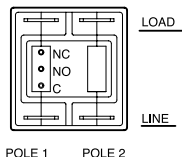

FIG. A

FLAT QC AND SOLDER LUG AUX SWITCH TERMINALS

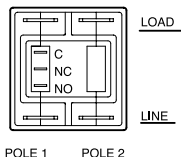
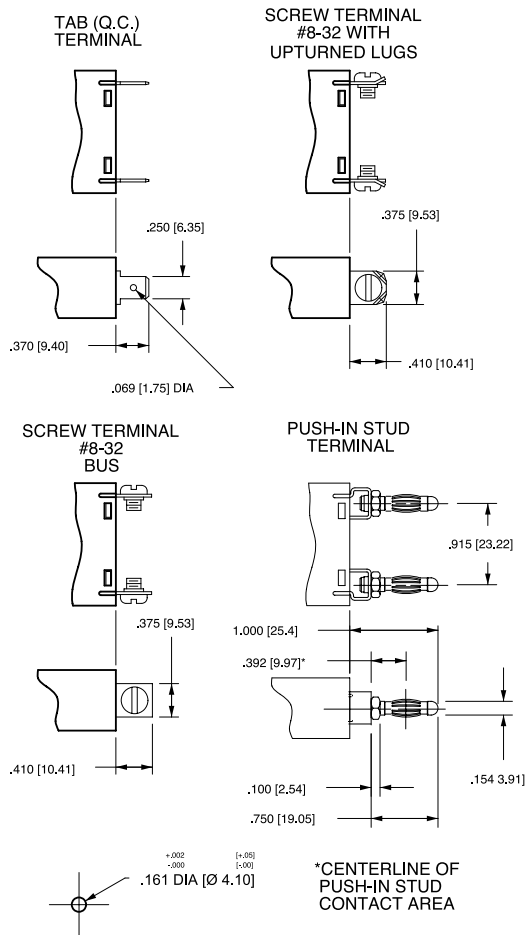
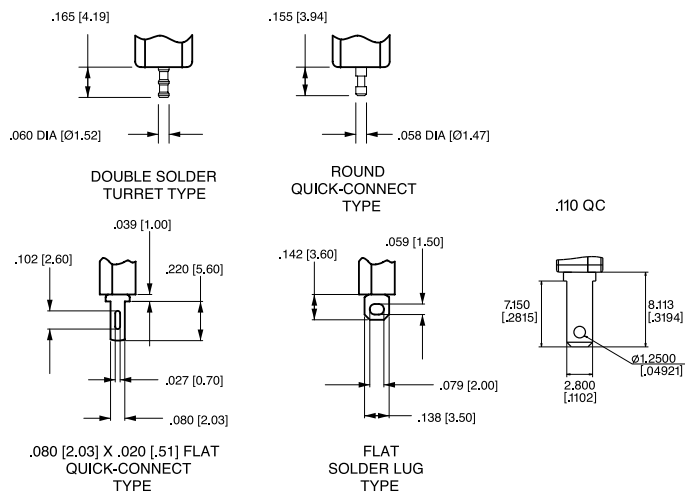

FIG. B

TERMINAL DIMENSIONAL DETAIL



AUXILIARY SWITCH TERMINALS



Notes:

- All dimensions are in inches [millimeters].
- Tolerance ±.020 [.51] unless otherwise specified.

PC Terminal Diagrams: in. [mm]

HANDLE TYPE SHOWN WITHOUT AUX. SWITCH

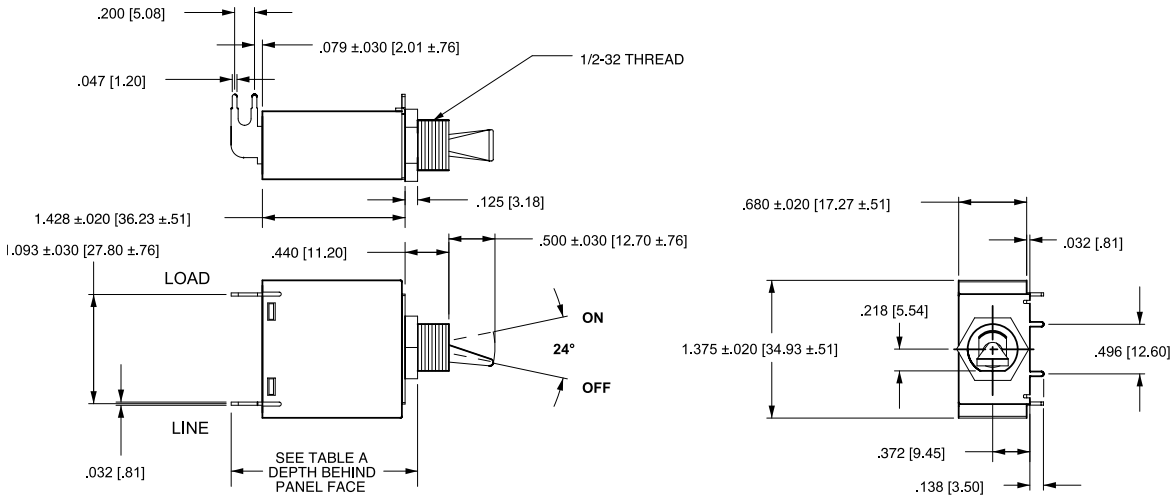

HANDLE TYPE SHOWN WITH AUX. SWITCH

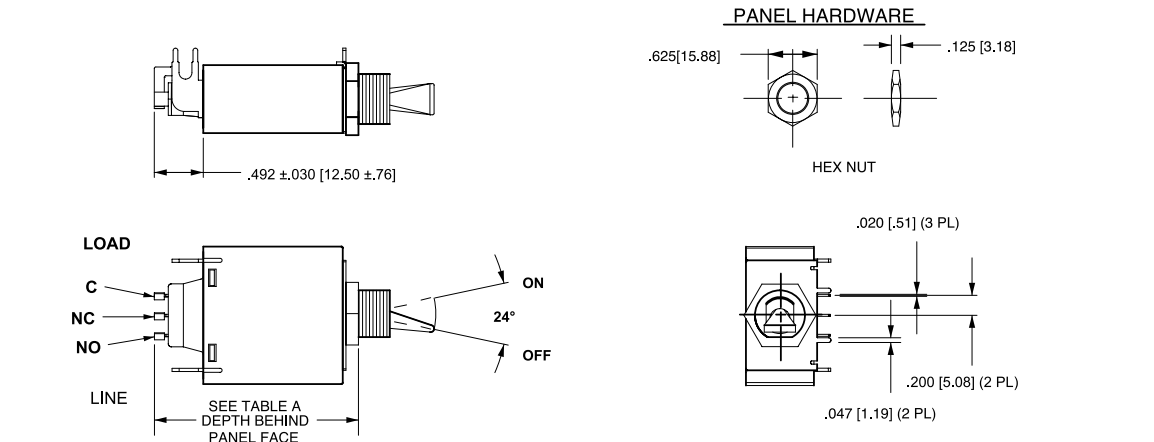

TABLE A		
	TERMINAL DESCRIPTION	DEPTH BEHIND PANEL FACE *
MAIN	PRINTED CIRCUIT BOARD	1.957 [49.71]
AUX. SWITCH	PRINTED CIRCUIT BOARD	2.449 [62.20]

*DEPTH INCLUDES BEHIND PANEL HEX NUT AS SUPPLIED ON ALL UNITS

- Notes:
 1 All dimensions are in inches [millimeters].
 2 Tolerance ± 0.020 [51] unless otherwise specified.

Dimensional Specifications: in. [mm]

PADDLE ACTUATOR STYLE

SINGLE POLE

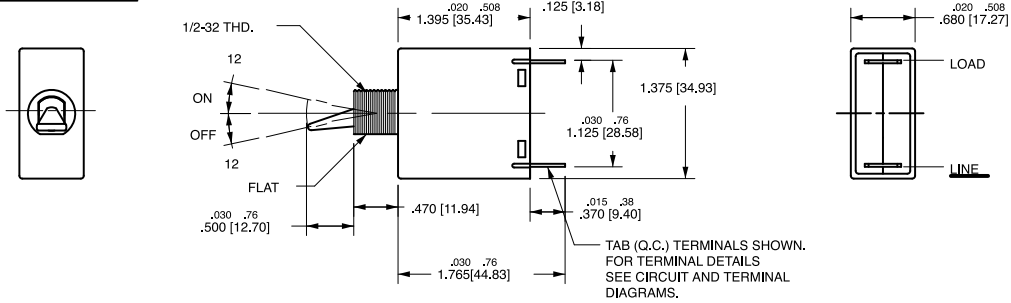

DOUBLE POLE

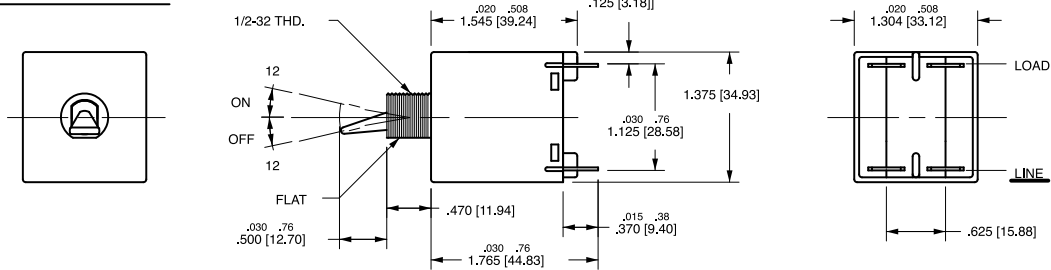

BATON ACTUATOR STYLE

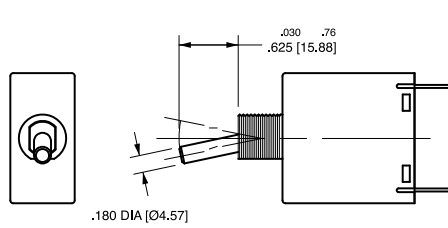

MOUNTING DETAILS

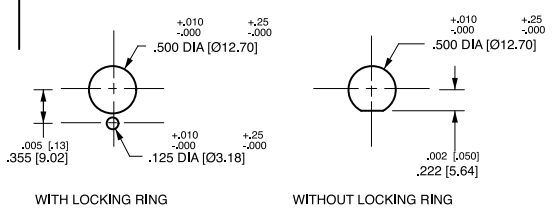

LEGEND PLATES

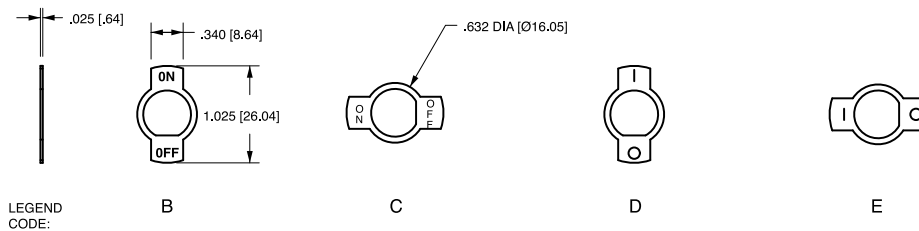

PANEL HARDWARE

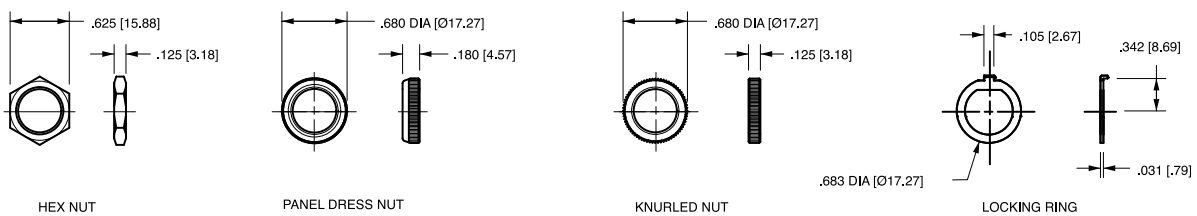

Notes:

- All dimensions are in inches [millimeters].
- Tolerance ± 0.020 [.51] unless otherwise specified.

Circuit & Terminal Diagrams: in. [mm]

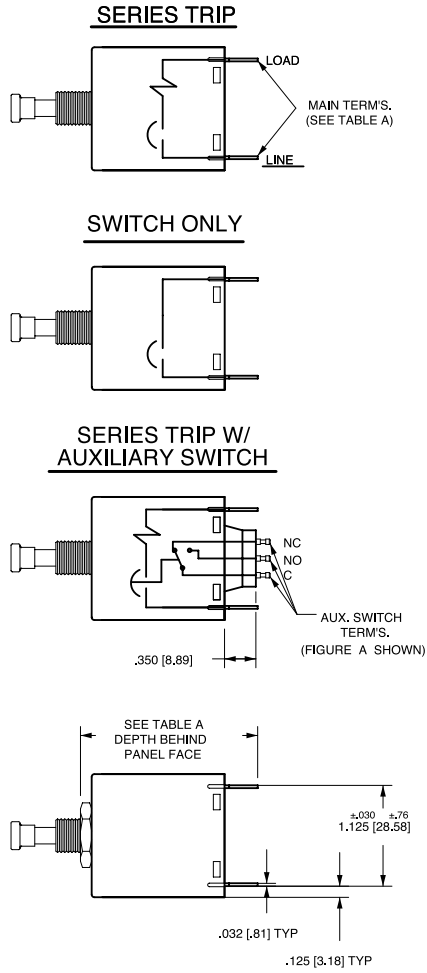

TERMINAL DESCRIPTION		DEPTH BEHIND PANEL FACE *
MAIN	TAB (Q.C.)	1.952 [49.57]
	SCREW (#8-32)	1.992 [50.60]
	PUSH-IN STUD	2.582 [65.58]
AUX. ** SWITCH	DOUBLE SOLDER TURRET TYPE	2.097 [53.26]
	ROUND Q.C. TYPE	2.087 [53.01]
	FLAT QUICK-CONNECT	2.191 [55.65]
	FLAT SOLDER LUG	2.074 [52.68]

*DEPTH INCLUDES BEHIND PANEL HEX NUT AS SUPPLIED ON ALL UNITS.

**WHEN CALLED FOR ON MULTI-POLE UNITS, ONLY ONE AUX. SWITCH IS NORMALLY SUPPLIED, MOUNTED AS SHOWN IN FIG. A

MULTI-POLE IDENTIFICATION SCHEME

SOLDER TURRET AND ROUND QC AUX SWITCH TERMINALS

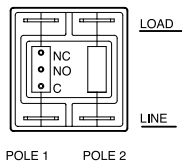

FIG. A

FLAT QC AND SOLDER LUG AUX SWITCH TERMINALS

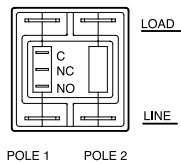
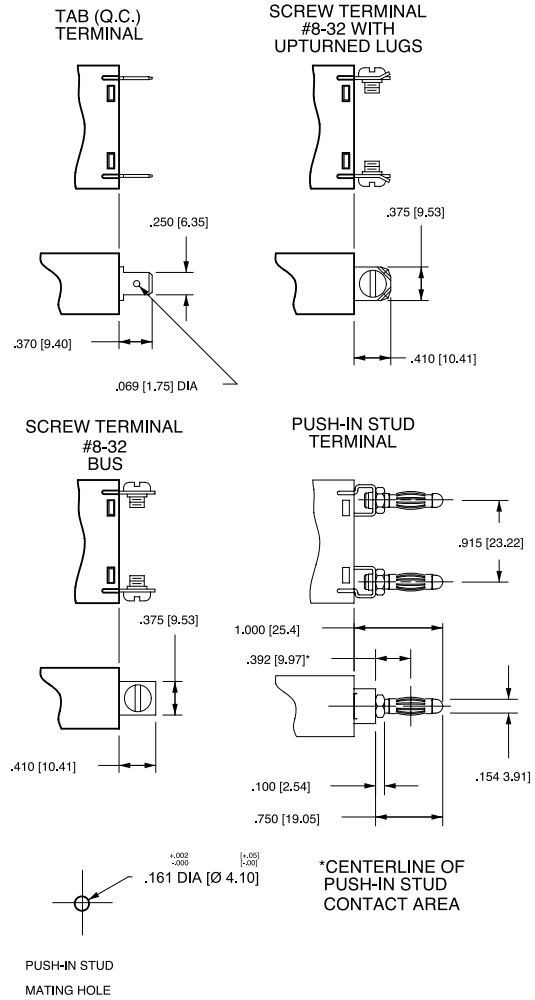

FIG. B

Notes:

- All dimensions are in inches [millimeters].
- Tolerance $\pm .020$ [.51] unless otherwise specified.

TERMINAL DIMENSIONAL DETAIL



AUXILIARY SWITCH TERMINALS

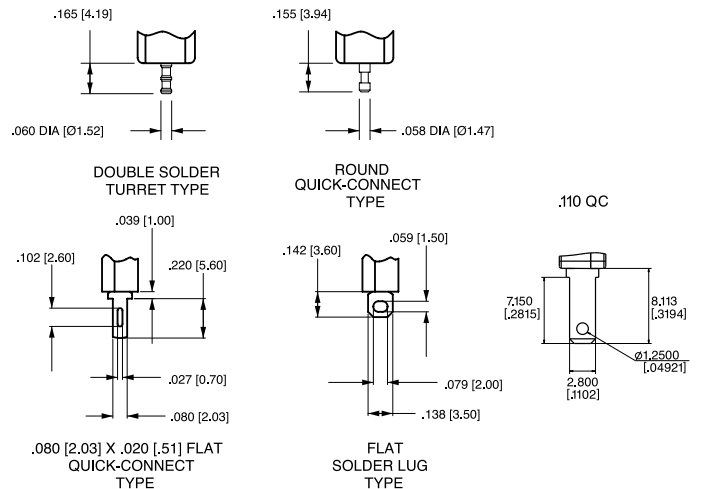

*AVAILABLE THROUGH SPECIAL CATALOG PART NUMBER

Dimensional Specifications: in. [mm]

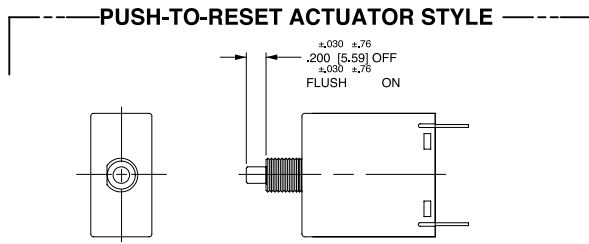
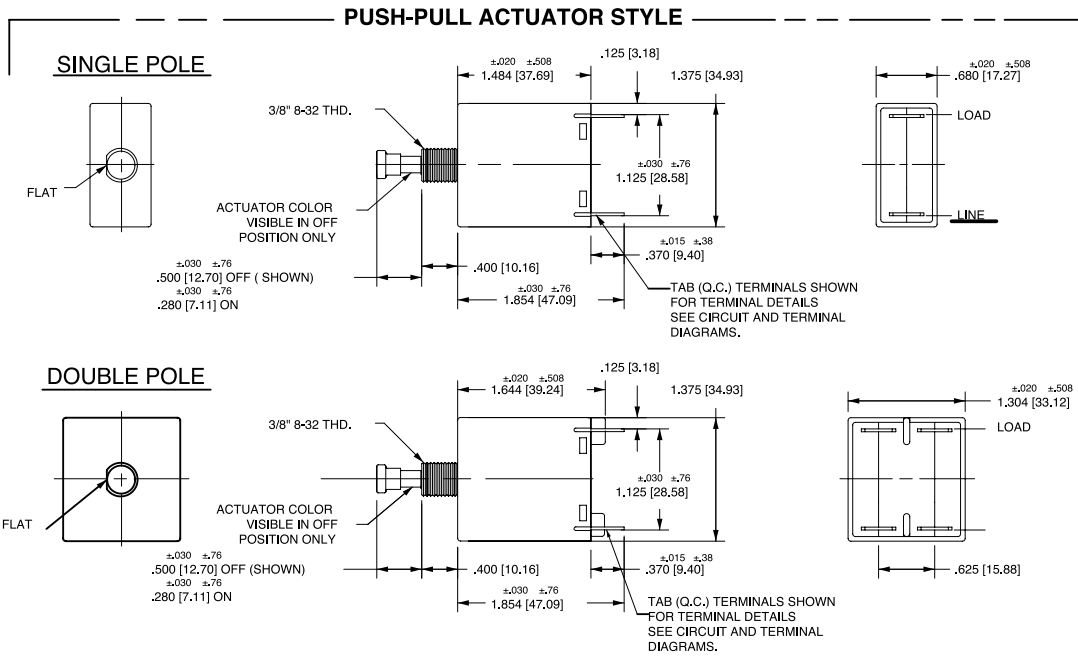

MOUNTING DETAILS

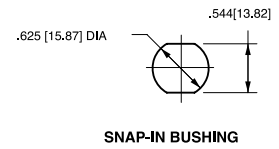
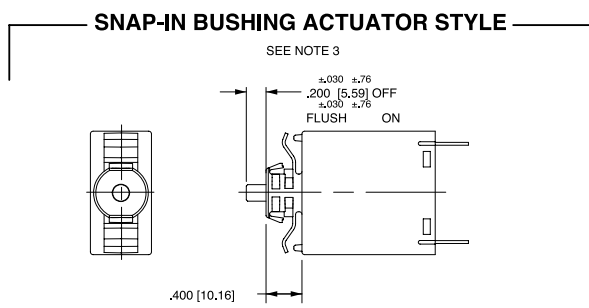
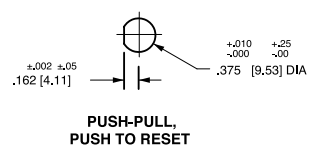

PANEL HARDWARE



BUTTON MARKING ORIENTATION (PUSH-PULL ONLY)

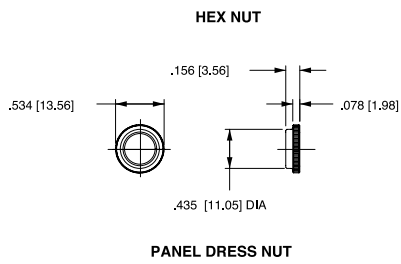
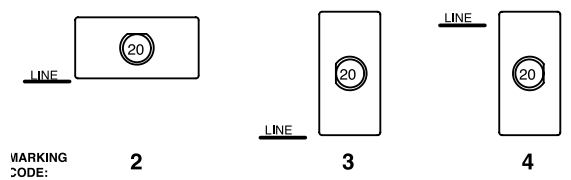

Notes:
 1 All dimensions are in inches [millimeters].
 2 Tolerance ± 0.20 [5.1] unless otherwise specified.
 3 Available with Push-Pull or Push-to-Reset Actuators

PC Terminal Diagrams: in. [mm]

PUSH-PULLTYPE SHOWN WITHOUT AUX. SWITCH

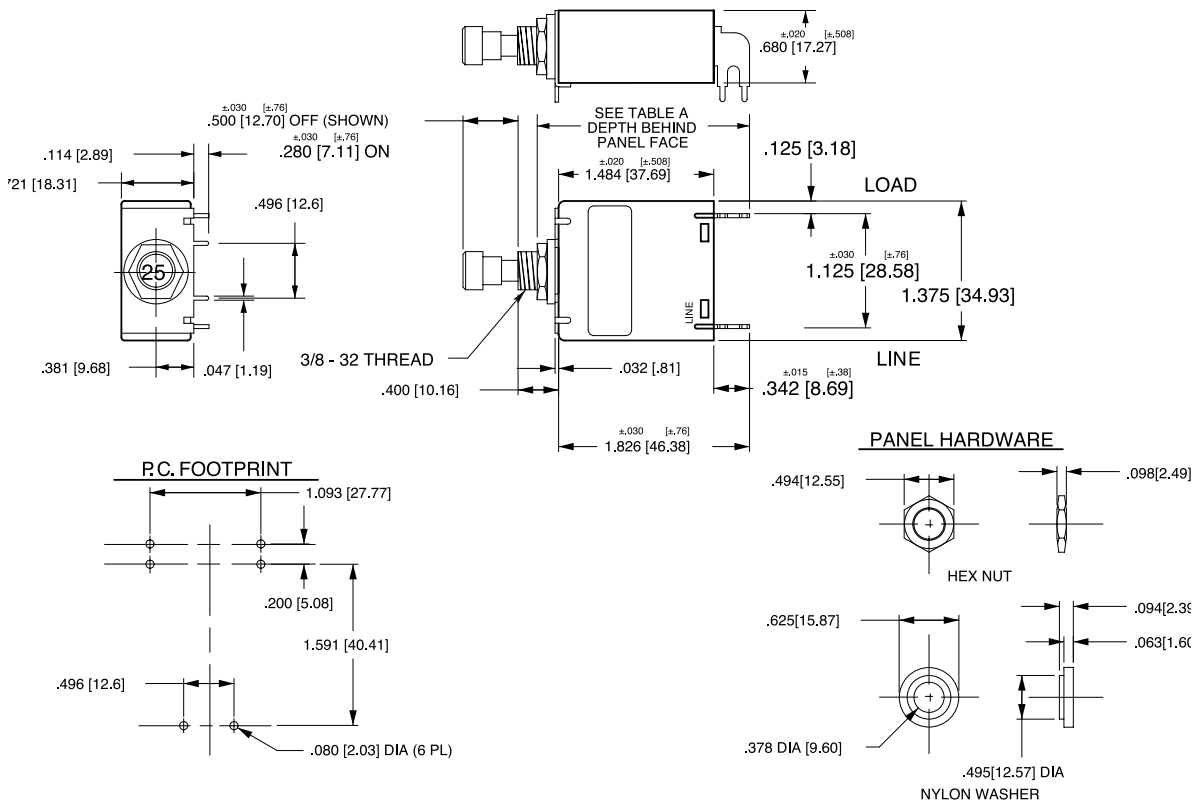

PUSH PULL TYPE SHOWN WITH AUX. SWITCH

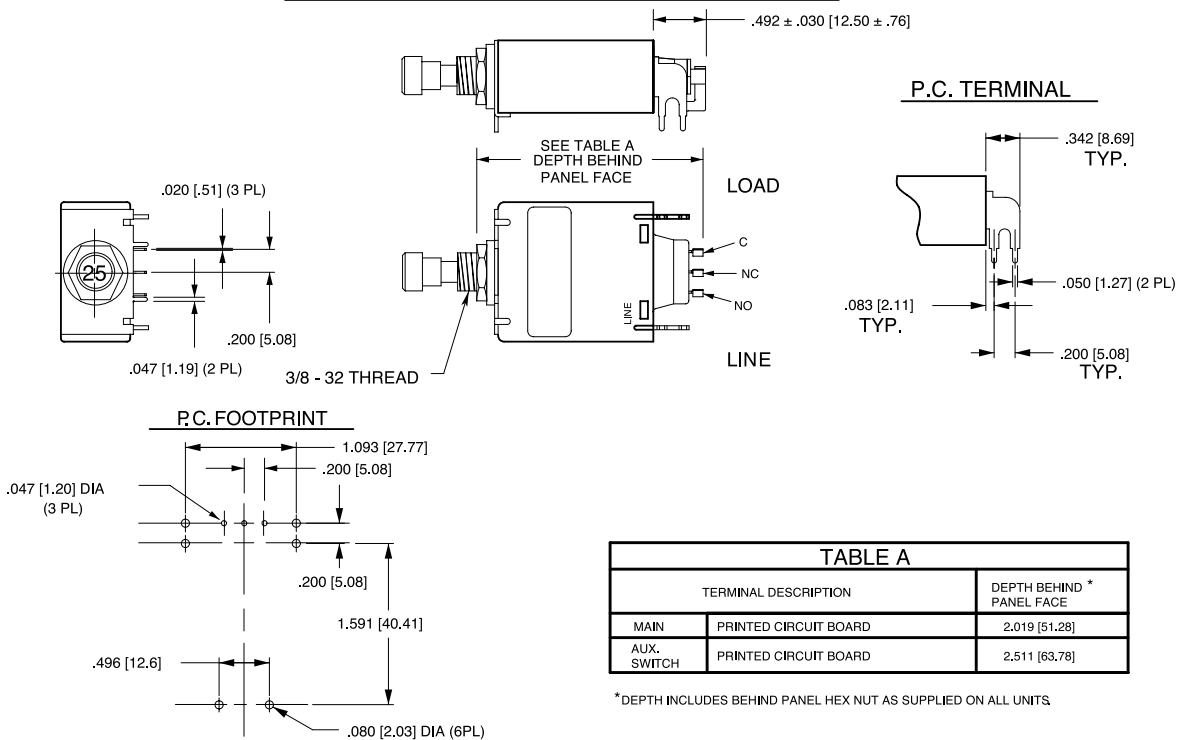

TABLE A		
TERMINAL DESCRIPTION		DEPTH BEHIND * PANEL FACE
MAIN	PRINTED CIRCUIT BOARD	2,019 [51.28]
AUX. SWITCH	PRINTED CIRCUIT BOARD	2,511 [63.78]

*DEPTH INCLUDES BEHIND PANEL HEX NUT AS SUPPLIED ON ALL UNITS.

Notes:
 1 All dimensions are in inches [millimeters].
 2 Tolerance $\pm.020$ [±.51] unless otherwise specified.



1 SERIES
M

2 ACTUATOR ¹
Non-Illuminated single color
A Angled
B Flat

Two Color Visi-Rocker
D Indicate ON
E Indicate OFF

illuminated single color
F Angled
G Flat

STYLE	INDICATE - "ON" (CODES A-D)	INDICATE - "OFF" (CODES E-G)	FLAT (CODES H & I)	ANGLED (CODES J & K)
VERTICAL				
HORIZONTAL				

3 POLES
1 One **2** Two

4 CIRCUIT ²
without Auxiliary Switch
A Switch Only (no coil), Maintained Contacts
B Series Trip (Current)

with Auxiliary Switch, Silver Contacts
M Series Trip (Current) Aux Switch
P ³ Switch Only, Maintained Contacts
Q ^{3,4} Switch Only, Maintained Contacts
R ^{3,16} Switch Only, Maintained Contacts
S ³ Series Trip (Current)
T ^{3,4} Series Trip (Current)
U ^{3,16} Series Trip, Maintained Contacts

with Auxiliary Switch, Gold Contacts
2 ^{3,4} Switch Only, Maintained Contacts
3 ^{3,16} Switch Only, Maintained Contacts
4 ^{3,4} Series Trip (Current)
5 ^{3,16} Series Trip, Maintained Contacts
9 Series Trip (Current) Aux Switch

Terminal Type:
.110 QC x .020 QC
.060 Dia, Round Solder Turret
.058 Dia, Round Q.C.
.080 Dia x .020 Flat Q.C.
.060 Dia, Round Solder Turret
.058 Dia, Round Q.C.
.080 Dia x .020 Flat Q.C.

5 FREQUENCY & DELAY

03 DC 50/60Hz, Switch Only	32 DC, 50/60Hz Short
10 DC Instantaneous	34 DC, 50/60Hz Medium
12 DC Short	62 50/60Hz Short, Hi-Inrush
14 DC Medium	64 50/60Hz Medium, Hi-Inrush
20 50/60Hz Instantaneous	72 DC, Short, Hi-Inrush
22 50/60Hz Short	74 DC, Medium, Hi-Inrush
24 50/60Hz Medium	92 DC, 50/60Hz Short, Hi-Inrush
30 DC, 50/60Hz Instantaneous	94 DC, 50/60Hz Medium, Hi-Inrush

VOLTAGE				FULL LOAD AMP RATING				GENERAL PURPOSE AMP RATING				TUNGSTEN LAMP RATING			
MAX. RATING	FREQUENCY	PHASE	MAX. AMPS	CHOOSE CURRENT RATING CODE:	MAX. AMPS	CHOOSE CURRENT RATING CODE:	MAX. AMPS	CHOOSE CURRENT RATING CODE:	MAX. AMPS	CHOOSE CURRENT RATING CODE:	MAX. AMPS	CHOOSE CURRENT RATING CODE:	MAX. AMPS	CHOOSE CURRENT RATING CODE:	POLES BREAKING
32	DC	-	15	615	25	625	-	-	-	-	-	-	-	-	1
50	DC	-	-	-	7.5	Consult Factory	-	-	-	-	-	-	-	-	1
65	DC	-	15	615	25	625	-	-	-	-	-	-	-	-	2
125	50/60HZ	1	15	615	25	625	-	15	-	615	-	-	-	-	1
250	50/60HZ	1	12	612	-	-	-	-	-	-	-	-	-	-	1
250	50/60HZ	1	15	615	25	625	-	-	-	-	-	-	-	-	2

- Notes:
- One actuator is located in the center of each multi-pole breaker.
 - For Switch Only circuits, select Current Coil Rating from the above chart.
 - One Auxiliary Switch is supplied per breaker. On two-pole breakers, standard Auxiliary Switch mounting is in pole one. Auxiliary Switch option limited to Series Trip & Switch Only circuits, & is not available in single pole illuminated breakers, or Back Connected Screw or Push-in Stud terminals.
 - Mates with AMP .058" diameter pin receptacles: 60983-1 (gold plated) & 60983-2 (tin plated).
 - For neon bulb applications at 120VAC @ 47K, 1/4 WATT and for 250VAC applications @ 150K, 1/4 WATT, external resistors must be supplied by customer.
 - On Visi-Rocker breakers, Visi portion of rocker cannot be the same color as the bezel.
 - For LED (DC or rectified AC) applications, LED is mounted in the center of the rocker actuator with electrical characteristics: 100 millicandela at 20mA; Maximum power dissipation = 75mW at 25°C; Maximum forward current = 25mA; Typical forward voltage = 2.1V at 20mA; Typical reverse current = 100uA at 3V. Customer supplies the proper external resistor limiting current to these values.
 - Rocker color for LED's and green neon lamp must be clear, smoke gray, white translucent or match color of LED or neon lamp.
 - Other colors available. Consult factory.
 - TUV 20A, VDE 15A. UL Recognized and CSA Accepted to 30 amps.
 - Screw Terminals or Push-in Stud recommended above 20 amps.
 - TUV or VDE Certified must have I-O or Dual Legends.
 - Legend required on Visi-Rocker breakers.
 - 30 amp rating not available with delay's 30, 32, 34, 92 or 94.
 - Screw Terminals are VDE certified only with use of ring terminal attached to wire.
 - Terminal code A available with circuit codes A & B only.
 - Printed circuit board available with UL recognized approval only.
 - Auxiliary switch (flat Q.C.) available with UL recognized approvals only.

6 CURRENT RATING (AMPERES)

CODE	AMPERES	
020	0.020	225 0.250
025	0.025	230 0.300
030	0.030	235 0.350
035	0.035	240 0.400
040	0.040	245 0.450
045	0.045	250 0.500
050	0.050	255 0.550
055	0.055	260 0.600
060	0.060	265 0.650
065	0.065	270 0.700
070	0.070	275 0.750
075	0.075	280 0.800
080	0.080	285 0.850
085	0.085	290 0.900
090	0.090	295 0.950
090	0.095	410 1.000
210	0.100	512 1.250
215	0.150	415 1.500
220	0.200	517 1.750
420	2.000	710 10.500
522	2.250	611 11.000
425	2.500	711 11.500
527	2.750	612 12.000
430	3.000	712 12.500
435	3.500	613 13.000
440	4.000	614 14.000
445	4.500	615 15.000
450	5.000	616 16.000
455	5.500	617 17.000
460	6.000	618 18.000
465	6.500	620 20.000
470	7.000	622 22.000
475	7.500	624 24.000
480	8.000	625 25.000
485	8.500	630 ¹² 30.000
490	9.000	
495	9.500	
610	10.000	

7 TERMINAL

1 Push-On 0.250 Tab (Q.C.)	A ¹⁴ Push-In Stud
2 ¹⁰ Screw 8-32 with Upturned Lugs	P ¹⁵ Printed Circuit Board
3 ¹⁰ Screw 8-32 (Bus Type)	

8 ROCKER ILLUMINATION
Non-Illuminated

Neon ⁵	A Neon	B Green Glow ⁸
without resistor, 120VAC/250VAC	C Red	D Green
LED ^{7,8}	E without resistor	F with resistor, 4-8 VDC
without resistor	G with resistor, 9-16 VDC	
	H	I Amber
	J	K L
		M

9 ACTUATOR & LEGEND COLOR

Solid Color	Actuator	Legend
1	White	Black
2	Black	White
3	Red	White
4	Green	White
5	Blue	White
6	Yellow	Black
7	Gray	Black
8	Orange	Black
Visi-Rocker ⁶	Visi & Legend (remainder of rocker same color as bezel)	
1	White	
2	Black	
3	Red	
4	Green	
5	Blue	
6	Yellow	
7	Gray	
8	Orange	
Illuminated ⁸	Actuator	Legend
A	Clear	White
B	Red Transparent	White
C	Green Transparent	White
D	Amber Transparent	White
E	Smoke Gray Transparent	White
F	White Translucent	Black

10 LEGEND ¹¹

1 No Legend	4 I - O Vertical
2 ON - OFF Vertical	5 I - O Horizontal
3 ON - OFF Horizontal	6 Dual Vertical
	7 Dual Horizontal

11 BEZEL COLOR / STYLE ⁹

Color	without Rockerguard	with Rockerguard
White	A	1
Black	B	2
Gray	G	7

12 AGENCY APPROVAL ¹⁰

C	UL Recognized & CSA Accepted
D	VDE Certified, UL Recognized & CSA Accepted
E	TUV Certified, UL Recognized & CSA Accepted



1 SERIES
M

2 ACTUATOR ¹

Non-Illuminated single color
A Angled
B Flat

Two Color Visi-Rocker
D Indicate ON
E Indicate OFF

illuminated single color
F Angled
G Flat

STYLE	INDICATE "ON" (CODES A, D)	INDICATE "OFF" (CODES B, E)	FLAT (CODES B, G)	ANGLED (CODES A, F)
VERTICAL				
HORIZONTAL				

3 POLES
1 One

4 CIRCUIT ²

without Auxiliary Switch
B Series Trip (Current)

with Auxiliary Switch, Silver Contacts
M Series Trip (Current) Aux Switch
S³ Series Trip (Current)
T^{3,4} Series Trip (Current)
U^{3,16} Series Trip, Maintained Contacts

with Auxiliary Switch, Gold Contacts
4^{3,4} Series Trip (Current)
5^{3,16} Series Trip, Maintained Contacts
9 Series Trip (Current) Aux Switch

Terminal Type:
 .110 QC x .020 QC
 .060 Dia, Round Solder Turret
 .058 Dia, Round Q.C.
 .080 Dia x .020 Flat Q.C.
 .058 Dia, Round Q.C.
 .080 Dia x .020 Flat Q.C.
 .110 QC x .020 QC

5 FREQUENCY & DELAY

10 DC Instantaneous	14 DC Medium
12 DC Short	72 DC, Short, Hi-Inrush
	74 DC, Medium, Hi-Inrush

6 CURRENT RATING (AMPERES)

CODE	AMPERES
020	0.020
025	0.025
030	0.030
035	0.035
040	0.040
045	0.045
050	0.050
055	0.055
060	0.060
065	0.065
070	0.070
075	0.075
080	0.080
085	0.085
090	0.090
090	0.095
210	0.100
215	0.150
220	0.200
225	0.250
230	0.300
235	0.350
240	0.400
245	0.450
250	0.500
255	0.550
260	0.600
265	0.650
270	0.700
275	0.750
280	0.800
285	0.850
290	0.900
295	0.950
410	1.000
512	1.250
415	1.500
517	1.750
420	2.000
522	2.250
425	2.500
527	2.750
430	3.000
435	3.500
440	4.000
445	4.500
450	5.000
455	5.500
460	6.000
465	6.500
470	7.000
475	7.500
480	8.000
485	8.500
490	9.000
495	9.500
610	10.000
710	10.500
611	11.000
711	11.500
612	12.000
712	12.500
613	13.000
614	14.000
615	15.000
616	16.000
617	17.000
618	18.000
620	20.000
622	22.000
624	24.000
625	25.000
630	30.000

- Notes:
- One actuator is located in the center of each multi-pole breaker.
 - One Auxiliary Switch is supplied per breaker. Auxiliary Switch option limited to Series Trip & Switch Only circuits, and is not available in single pole illuminated breakers, or with Back Connected Screw or Push-in Stud terminals.
 - Mates with AMP .058" diameter pin receptacles: 60983-1 (gold plated) & 60983-1 (tin plated).
 - For neon bulb applications at 120VAC @ 47K, 1/4 WATT and for 250VAC applications @ 150K, 1/4 WATT, external resistors must be supplied by customer.
 - For LED (DC or rectified AC) applications, LED is mounted in the center of the rocker actuator with electrical characteristics as follows: 100 millicandela at 20mA; Maximum power dissipation = 75mW at 25°C; Maximum forward current = 25mA; Typical forward voltage = 2.1V at 20mA; Typical reverse current = 100uA at 3V. Customer supplies the proper external resistor limiting current to these values.
 - On Visi-Rocker breakers, Visi portion of rocker cannot be the same color as the bezel.
 - Rocker color for LED's and green neon lamp must be clear, smoke gray, white translucent or match color of LED or neon lamp.
 - Other colors available. Consult factory.
 - UL Recognized, CSA Accepted, UL489A Listed, and TUV Certified to 30 amps. Screw Terminals recommended above 20 amps.
 - UL489A Listed must have ON-OFF or Dual legends. TUV Certified approvals must have I - O or Dual legends.
 - Terminal code A available with circuit codes A & B only.
 - Printed circuit board available with UL recognized approval only.
 - Auxiliary switch (flat Q.C.) available with UL recognized approvals only.

7 TERMINAL

1 Push-On 0.250 Tab (Q.C.)	A ¹¹ Push-In Stud
2 Screw 8-32 with Upturned Lugs	P ¹² Printed Circuit Board
3 Screw 8-32 (Bus Type)	

8 ROCKER ILLUMINATION

Non-illuminated Neon ⁴
 without resistor, 120VAC/250VAC
LED ^{7, 8}
 without resistor
 with resistor, 4-8 VDC
 with resistor, 9-16 VDC

A Neon	C Green Glow ⁸
B Red	G Green
D Blue	H Amber
E Yellow	I Black
F Gray	J Black

9 ACTUATOR & LEGEND COLOR

Solid Color	Actuator	Legend
1	White	Black
2	Black	White
3	Red	White
4	Green	White
5	Blue	White
6	Yellow	Black
7	Gray	Black
8	Orange	Black

Visi-Rocker ⁶ Visi & Legend (remainder of rocker same color as bezel)

1	White
2	Black
3	Red
4	Green
5	Blue
6	Yellow
7	Gray
8	Orange

Illuminated ⁷

A Clear	Legend White
B Red Transparent	White
C Green Transparent	White
D Amber Transparent	White
E Smoke Gray Transparent	White
F White Translucent	Black

10 LEGEND ¹⁰

1	No Legend (Single Color or Illuminated Rocker Options Only)
2	ON - OFF Vertical
3	ON - OFF Horizontal
4	I - O Vertical
5	I - O Horizontal
6	Dual Vertical
7	Dual Horizontal

11 BEZEL COLOR / STYLE ⁸

Color	without Rockerguard	with Rockerguard
White	A	1
Black	B	2
Gray	G	7

12 AGENCY APPROVAL ⁹

J	UL489A Listed & TUV Certified
M	UL Recognized & CSA Accepted
N	TUV Certified, UL Recognized & CSA Accepted
T	UL489A Listed

Circuit & Terminal Diagrams: in. [mm]

SERIES TRIP

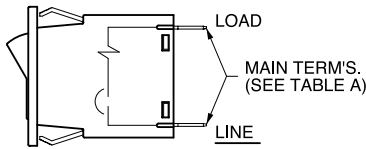

SERIES TRIP W/ ILLUMINATED ROCKER

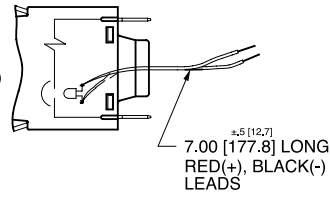

SWITCH ONLY

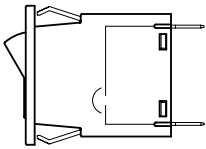

SWITCH ONLY W/ ILLUMINATED ROCKER

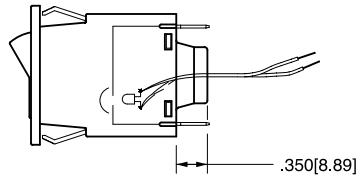

SERIES TRIP W/ AUXILIARY SWITCH

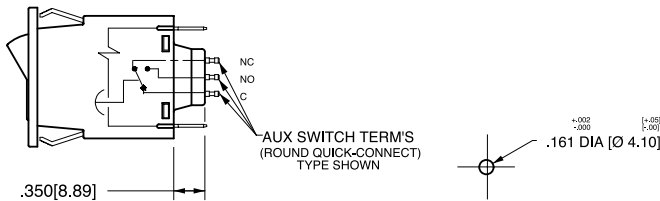

PUSH-IN STUD
MATING HOLE

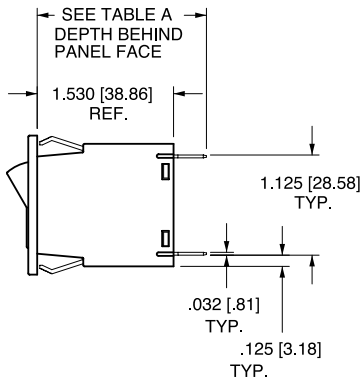

TERMINAL DIMENSIONAL DETAIL

TAB (Q.C.) TERMINAL

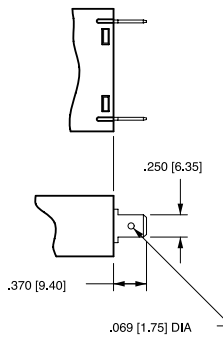

SCREW TERMINAL #8-32 WITH UPTURNED LUGS

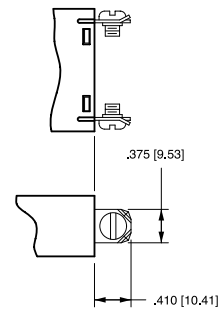

SCREW TERMINAL #8-32 BUS

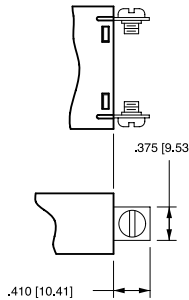

PUSH-IN STUD TERMINAL

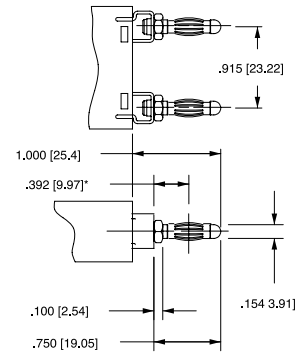

*CENTERLINE OF
PUSH-IN STUD
CONTACT AREA

AUXILIARY SWITCH TERMINALS

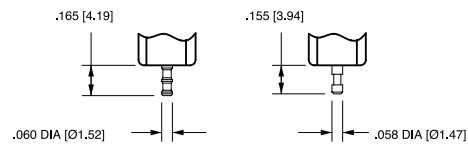

DOUBLE SOLDER TURRET TYPE

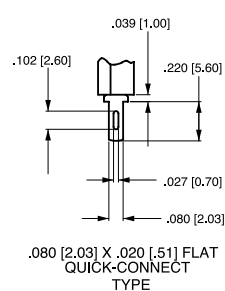

ROUND QUICK-CONNECT TYPE

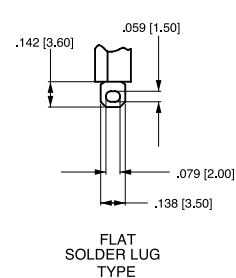

*AVAILABLE THROUGH SPECIAL
CATALOG PART NUMBER

.110 QC

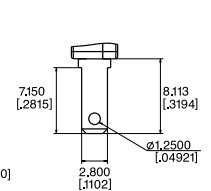

TABLE - A		
TERMINAL DESCRIPTION		DEPTH BEHIND PANEL FACE
MAIN	TAB (Q.C.)	1.900 [48.26]
	SCREW (#8-32)**	1.940 [49.28]
	PUSH-IN STUD	2.530 [64.26]
*AUX. SWITCH	DOUBLE SOLDER TURRET TYPE	2.045 [51.94]
	ROUND Q.C. TYPE	2.035 [51.69]
	FLAT QUICK CONNECT	2.139 [54.33]
	FLAT SOLDER LUG	2.022 [51.36]

* AUX. SWITCH IS NOT AVAILABLE ON SINGLE POLE ILLUMINATED UNITS. WHEN CALLED FOR ON MULTI-POLE UNITS, ONLY ONE AUX. SWITCH IS NORMALLY SUPPLIED, MOUNTED AS SHOWN ON CLA-8003.

** RECOMMENDED TIGHTENING TORQUE 12-15 IN LBS [1.4-2.7 NM]

Notes:

- All dimensions are in inches [millimeters].
- Tolerance ± 0.020 [.51] unless otherwise specified.
- Schematic shown represents current trip circuit.

Dimensional Specifications: in. [mm]

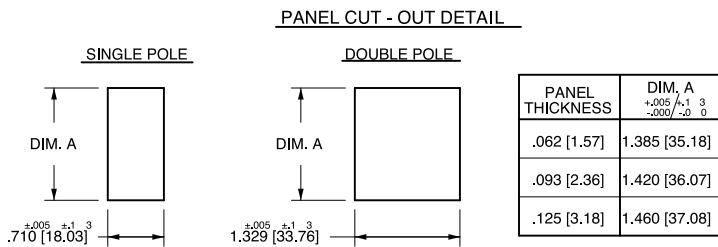
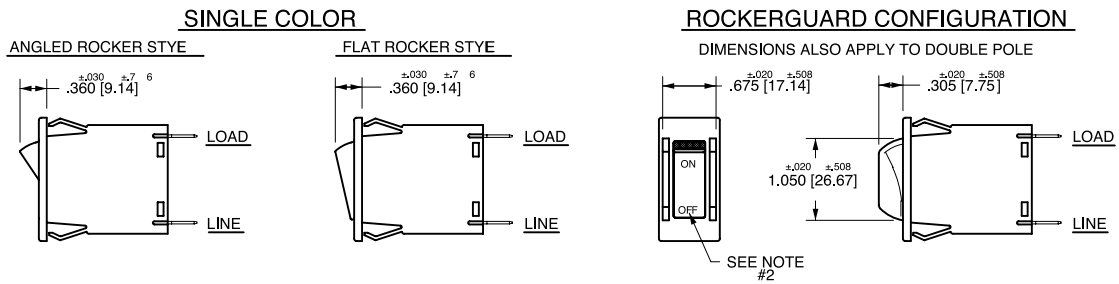
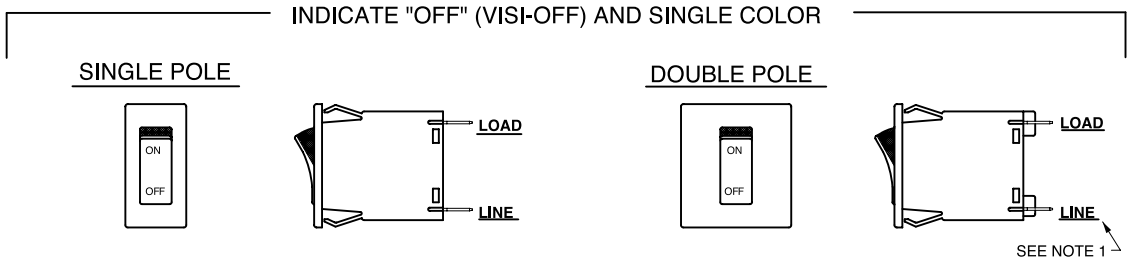
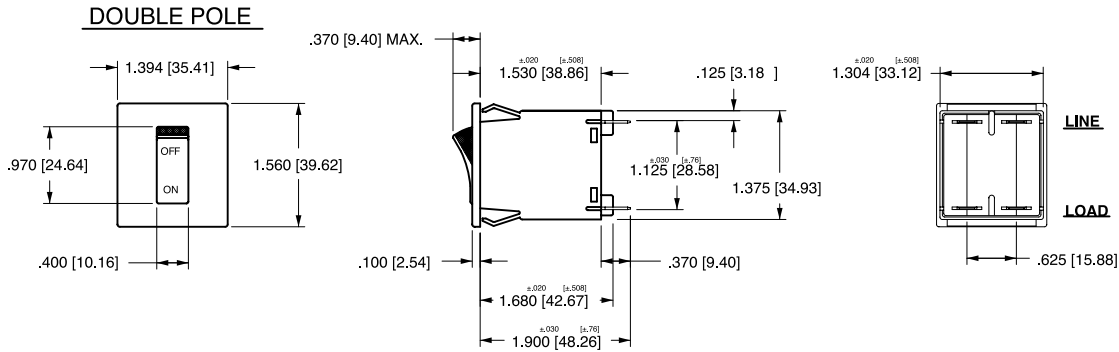
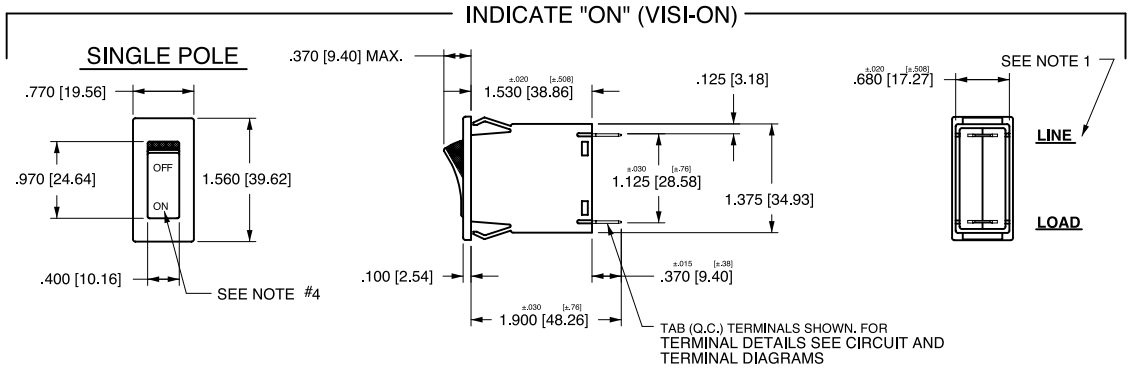

- Notes:
- 1 Dimensions apply to all variations shown. Notice that circuit breaker line & load terminal orientation on indicate OFF is opposite of indicate ON.
 - 2 I-O, ON-OFF or dual legends available for vertical or horizontal mounting. For pole orientation with horizontal legend, rotate front view clockwise 90°.
 - 3 All dimensions are in inches [millimeters].
 - 4 Tolerance ± 0.20 [.51] unless otherwise specified.

ONE POLE

SINGLE POLE / ROCKER BREAKERS SHOWN WITH DOUBLE SOLDER TURRET AND ROUND QC AUX. SWITCH TERMINALS

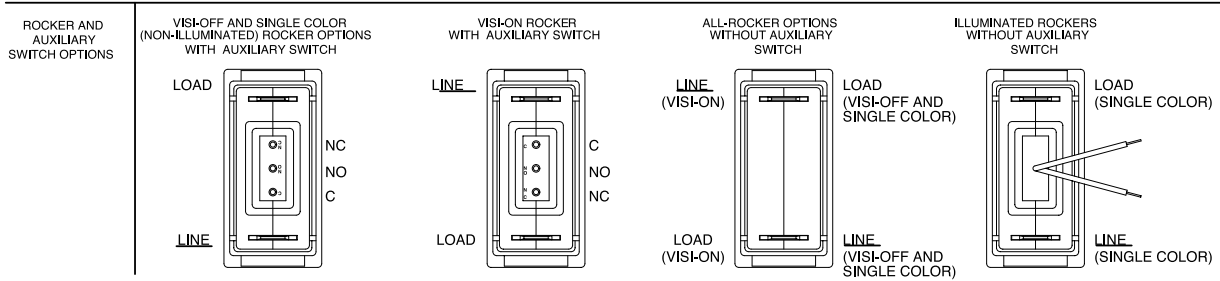

SINGLE POLE / ROCKER BREAKERS SHOWN WITH FLAT QC AND FLAT SOLDER LUG AUX. SWITCH TERMINALS

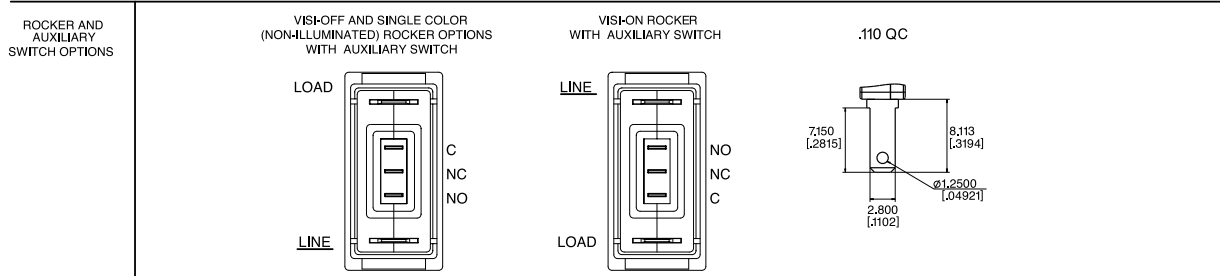

TWO POLE

DOUBLE POLE / ROCKER BREAKERS SHOWN WITH DOUBLE SOLDER TURRET AND ROUND QC AUX. SWITCH TERMINALS

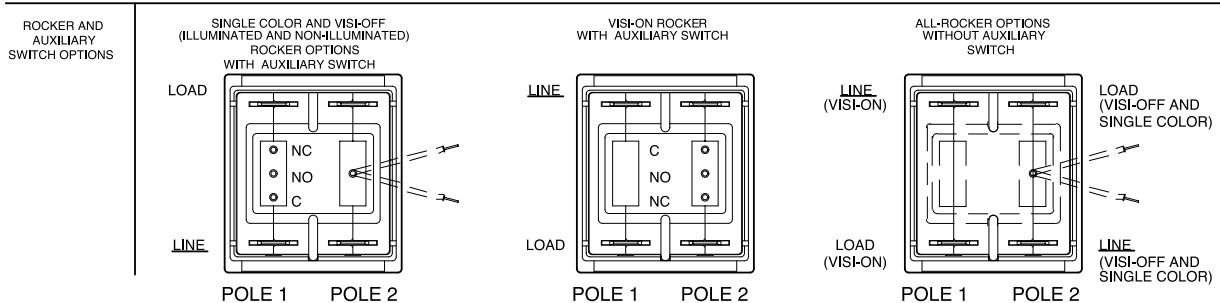

DOUBLE POLE / ROCKER BREAKERS SHOWN WITH FLAT QC AND FLAT SOLDER LUG AUX. SWITCH TERMINALS

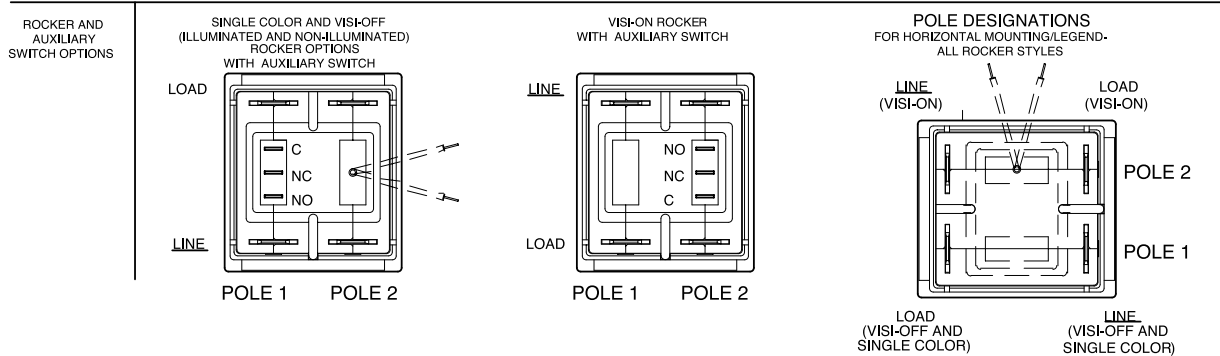

M, MS-SERIES TIME DELAY VALUES										
TRIP TIME SECONDS	PERCENT OF RATED CURRENT									
	Delay	100%	135%	150%	200%	400%	600%	800%	1000%	1200%
	10, 20, 30	No Trip	May Trip	.100 Max	.100 Max	.100 Max	.100 Max	.100 Max	.100 Max	.100 Max
12, 22, 32, 62, 72, 92	No Trip	.300 - 7.00	.200 - 5.00	.100 - 2.00	.030 - .500	.008 - .300	.006 - .150	.005 - .100	.005 - .100	.005 - .100
14, 24, 34, 64, 74, 94	No Trip	3.00 - 70.0	2.00 - 40.0	1.00 - 15.0	.100 - 4.00	.008 - 2.00	.006 - .800	.005 - .350	.005 - .160	.005 - .160

Notes:

- 1 Delay Curves 12,14, 22, 24, 32, 34, 62, 64, 72, 74, 92, 94: Breakers to hold 100% and must trip at 135% of rated current and greater within the time limit shown in this curve.
- 2 Delay Curves 10, 20, 30: Breakers to hold 100% and must trip at 150% of rated current and greater within the time limit shown in this curve.
- 3 All Curves: Curve data shown represents breaker response at ambient temperature of 77°F (25°C) with no preloading. Breakers are mounted in standard wall-mount position.
- 4 The minimum inrush pulse tolerance handling capability is 12 times the rated current on standard delays and 18 times the rated current on high inrush delays. These values are based on a 60 Hz 1/2 cycle, 8.33 ms pulse. High inrush delays should be specified for applications with high initial surge currents of short duration, such as switching power supplies, highly capacitive loads and transformer loads.

Dual Rated AC/DC

Instantaneous

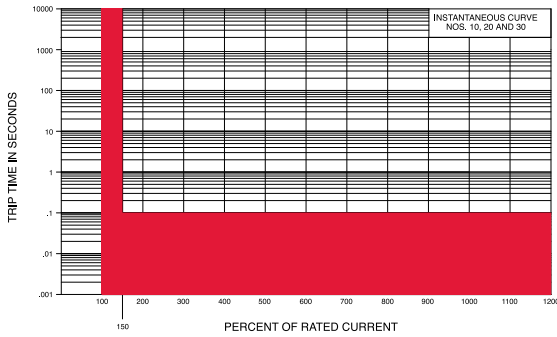

Short

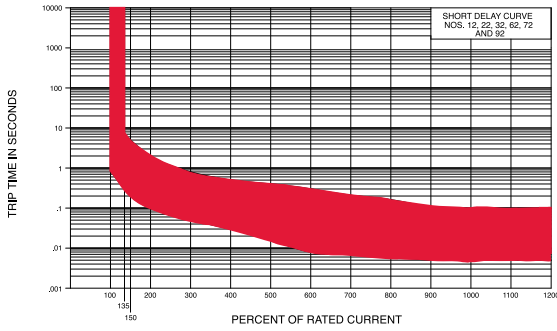

Short D2

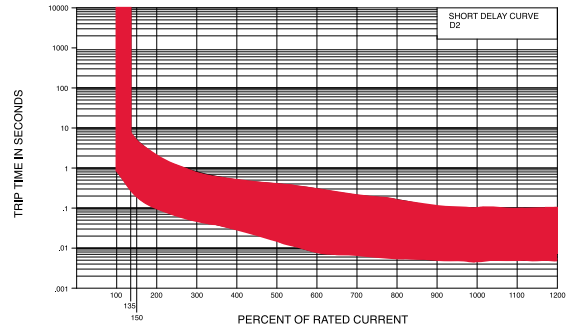

Medium

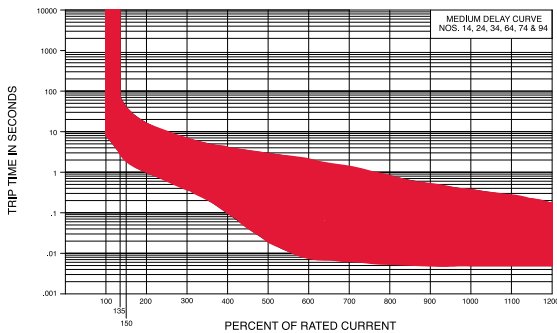

Medium D4

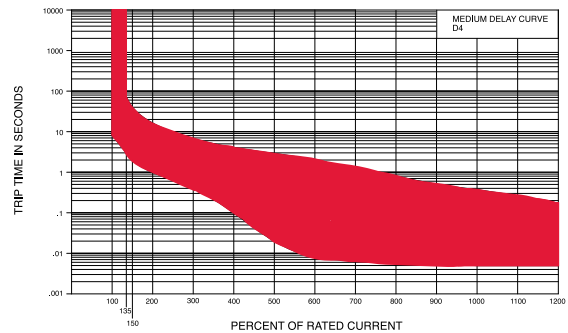

Authorized Sales Representatives and Distributors

Click on a region of the map below to find your local representatives and distributors or visit www.carlingtech.com/findarep.



About Carling

Founded in 1920, Carling Technologies is a leading manufacturer of electrical and electronic switches and assemblies, circuit breakers, electronic controls, power distribution units, and multiplexed power distribution systems. With four ISO registered manufacturing facilities and technical sales offices worldwide, Carling Technologies Sales, Service and Engineering teams do much more than manufacture electrical components, they engineer powerful solutions! To learn more about Carling please visit www.carlingtech.com/company-profile.

To view all of Carling's environmental, quality, health & safety certifications please visit www.carlingtech.com/environmental-certifications

Worldwide Headquarters

Carling Technologies, Inc.
60 Johnson Avenue, Plainville, CT 06062
Phone: 860.793.9281 **Fax:** 860.793.9231
Email: sales@carlingtech.com

Northern Region Sales Office: nrsm@carlingtech.com
Southeast Region Sales Office: sersm@carlingtech.com
Midwest Region Sales Office: mrrsm@carlingtech.com
West Region Sales Office: wrsm@carlingtech.com
Latin America Sales Office: larsm@carlingtech.com

Asia-Pacific Headquarters

Carling Technologies, Asia-Pacific Ltd.,
Suite 1607, 16/F Tower 2, The Gateway,
Harbour City, 25 Canton Road,
Tsimshatsui, Kowloon, Hong Kong
Phone: Int + 852-2737-2277 **Fax:** Int + 852-2736-9332
Email: sales@carlingtech.com.hk

Shenzhen, China: shenzhen@carlingtech.com
Shanghai, China: shanghai@carlingtech.com
Pune, India: india@carlingtech.com
Kaohsiung, Taiwan: taiwan@carlingtech.com
Yokohama, Japan: japan@carlingtech.com

Europe | Middle East | Africa Headquarters

Carling Technologies LTD
4 Airport Business Park, Exeter Airport,
Clyst Honiton, Exeter, Devon, EX5 2UL, UK
Phone: Int + 44 1392.364422 **Fax:** Int + 44 1392.364477
Email: ltd.sales@carlingtech.com

Germany: gmbh@carlingtech.com
France: sas@carlingtech.com



Carling Technologies®

Innovative Designs. Powerful Solutions.

Mouser Electronics

Authorized Distributor

Click to View Pricing, Inventory, Delivery & Lifecycle Information:

Carling Technologies:

[MA1-B-34-430-1-A162-C](#) [MA1-B-34-615-2A26-2-C](#) [MD1-B-34-615-1-A36-B-C](#) [MB1-B-34-450-1-A27-B-C](#) [MA1-B-34-450-1-A26-B-C](#) [MB1-B-34-450-1-A26-B-C](#) [MB2-B-34-610-1-A24-B-C](#) [MB2-B-34-615-1-A24-B-C](#) [MB2-B-34-625-1-A27-B-C](#) [MB2-B-34-610-1-A27-B-C](#) [MB2-B-34-615-1-A27-B-C](#) [MB2-B-34-620-1-A27-B-C](#) [MA1-B-34-475-1-A12-B-C](#) [MA1-B-34-450-1-A12-B-C](#) [MD2-B-34-610-1-A36-B-C](#) [MD2-B-34-615-1-A36-B-C](#) [MB2-B-34-420-1-A24-B-C](#) [MB2-B-34-470-1-A24-B-C](#) [MF1-B-34-610-1-DB7-B-C](#) [MF1-B-34-620-1-DB7-B-C](#) [MF1-B-34-615-1-DB7-B-C](#) [MA1-B-34-625-1-A26-B-C](#) [MB1-B-34-615-1-A27-B-C](#) [MA1-B-34-610-1-A26-B-C](#) [MA1-B-34-615-1-A26-B-C](#) [MB1-B-34-610-1-A27-B-C](#) [MB1-B-34-615-1-A26-B-C](#) [MB1-B-34-610-1-A26-B-C](#) [MB1-B-34-625-1-A27-B-C](#) [MB1-B-34-620-1-A26-B-C](#) [MA1-B-34-620-1-A26-B-C](#) [MB1-B-34-620-1-A27-B-C](#) [MB1-B-34-625-1-A26-B-C](#) [MA1-B-34-625-1-A32-B-C](#) [MA1-B-34-625-1-A12-B-C](#) [MA1-B-34-615-1-A12-B-C](#) [MA1-B-34-610-1-A12-B-C](#) [MA1-B-34-620-1-A12-B-C](#) [MA1-B-94-450-1-A86-B-C](#) [MA2-4-34-615-2-A22-7-C](#) [MA2-4-34-625-2-A22-7-C](#) [MA2-4-34-625-2-A32-7-C](#) [MA2-4-34-625-2-A36-7-C](#) [MA2-A-03-615-1-A16-2-C](#) [MA2-A-03-615-1-A22-2-C](#) [MA2-A-03-615-1-A24-2-C](#) [MA2-A-03-625-1-A12-2-C](#) [MA2-A-03-625-1-A12-B-C](#) [MA2-A-03-625-1-A14-2-C](#) [MA2-A-03-625-1-A16-2-C](#) [MA2-A-03-625-1-A21-2-C](#) [MA2-A-03-625-1-A21-B-C](#) [MA2-A-03-625-1-A22-B-C](#) [MA2-A-03-625-1-A24-2-C](#) [MA2-A-03-625-1-A24-B-C](#) [MA2-A-03-625-1-A84-2-C](#) [MA2-A-03-625-2-A21-2-C](#) [MA2-A-03-625-2-A35-B-C](#) [MA2-A-03-625-3-A24-2-C](#) [MA2-B-14-620-1-A26-2-C](#) [MA2-B-20-420-1-A26-2-D](#) [MA2-B-20-610-1-A22-B-E](#) [MA2-B-22-420-1-A24-B-D](#) [MA2-B-22-420-1-A26-2-D](#) [MA2-B-22-430-1-A14-B-D](#) [MA2-B-22-450-1-A14-B-D](#) [MA2-B-22-450-1-A24-2-D](#) [MA2-B-22-475-1-A14-B-D](#) [MA2-B-22-475-1-A34-B-E](#) [MA2-B-22-610-1-A25-B-C](#) [MA2-B-22-610-1-A25-B-D](#) [MA2-B-22-610-1-A26-B-D](#) [MA2-B-22-612-1-A24-2-D](#) [MA2-B-22-614-1-A24-2-D](#) [MA2-B-22-615-1-A14-B-D](#) [MA2-B-22-615-1-A16-B-D](#) [MA2-B-22-615-1-A26-B-D](#) [MA2-B-22-615-1-A32-2-D](#) [MA2-B-22-615-1-A36-1-D](#) [MA2-B-22-615-1-A36-B-D](#) [MA2-B-22-620-1-A24-B-C](#) [MA2-B-24-410-1-A24-B-D](#) [MA2-B-24-420-1-A14-B-D](#) [MA2-B-24-420-1-A24-B-D](#) [MA2-B-24-420-1-A26-B-D](#) [MA2-B-24-425-1-A24-B-D](#) [MA2-B-24-430-1-A14-B-D](#) [MA2-B-24-430-1-A24-B-D](#) [MA2-B-24-440-1-A14-2-D](#) [MA2-B-24-440-1-A14-B-D](#) [MA2-B-24-440-1-A15-B-D](#) [MA2-B-24-440-1-A16-B-D](#) [MA2-B-24-440-1-A24-B-D](#) [MA2-B-24-440-3-A15-B-E](#) [MA2-B-24-450-1-A14-1-D](#) [MA2-B-24-450-1-A14-B-D](#) [MA2-B-24-450-1-A16-2-D](#) [MA2-B-24-450-1-A24-B-D](#) [MA2-B-24-450-1-A34-2-D](#) [MA2-B-24-460-1-A14-2-D](#)