

1A step down switching regulator

Features

- Up to 1A step down converter
- Operating input voltage from 8V to 55V
- Precise 5.1V reference voltage
- Output voltage adjustable from 0.5V to 50V
- Switching frequency adjustable up to 300kHz
- Voltage feedforward
- Zero load current operation
- Internal current limiting (pulse-by-pulse and hiccup mode)
- Protection against feedback disconnection
- Thermal shutdown

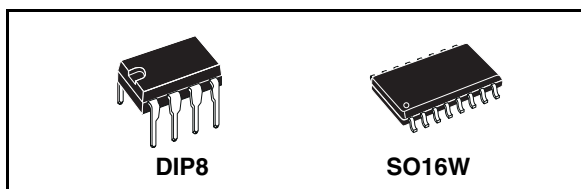

Description

The L4976 is a step down monolithic power switching regulator delivering 1A at a voltage between 3.3V and 50V (selected by a simple external divider). Realized in BCD mixed technology, the device uses an internal power D-MOS transistor (with a typical $R_{ds(ON)}$ of 0.25Ω) to obtain very high efficiency and high switching speed. A switching frequency up to 300kHz is achievable (the maximum power dissipation of the packages must be observed). A wide input voltage range between 8V to 55V and output voltages regulated from 3.3V to 40V cover the majority of today's applications. Features of this new generations of DC-DC converter include pulse-by-pulse current limit, hiccup mode for short circuit protection, voltage feedforward regulation, protection against feedback loop disconnection and thermal shutdown. The device is available in plastic dual in line, MINIDIP 8 for standard assembly, and SO16W for SMD assembly.

Figure 1. Typical application circuit

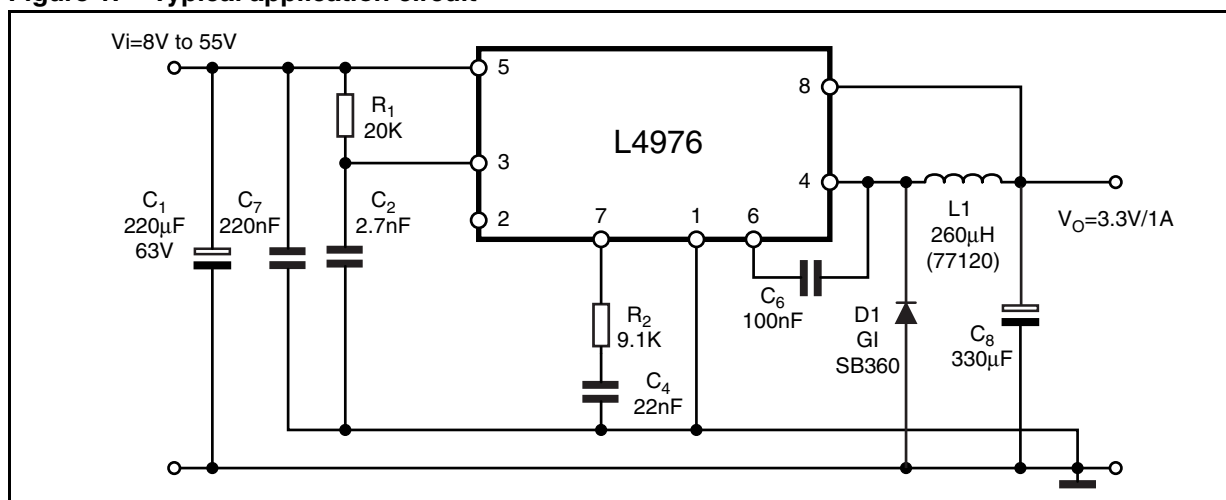

Contents

1	Block diagram	3
2	Pin settings	4
2.1	Pin connection	4
2.2	Pin description	4
3	Electrical data	5
3.1	Maximum ratings	5
3.2	Thermal data	5
3.3	Operating temperature rating	5
4	Electrical characteristics	7
5	Typical characteristics	9
6	Package mechanical data	13
7	Order code	16
8	Revision history	17

1 Block diagram

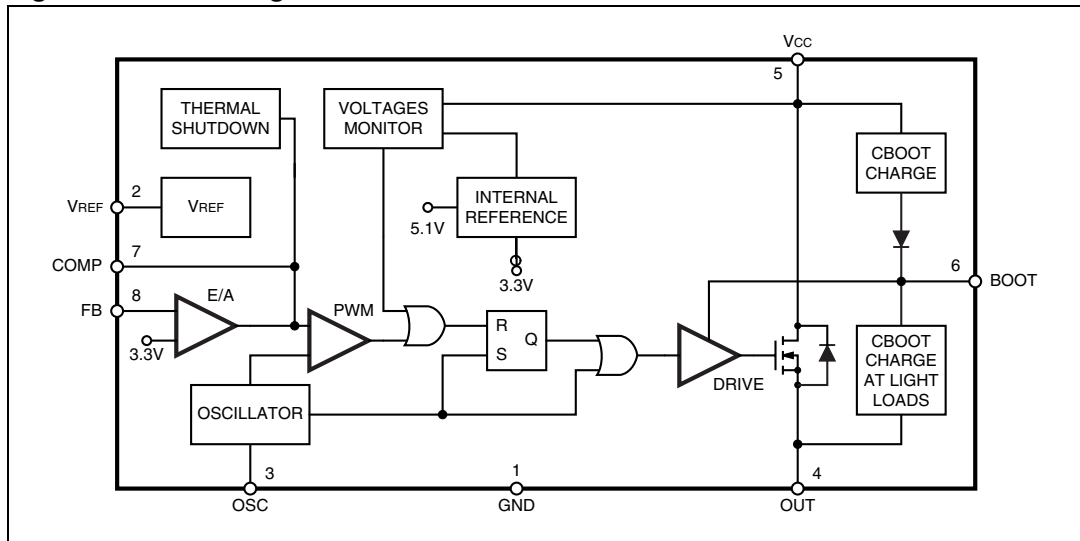
Figure 2. Block diagram

2 Pin settings

2.1 Pin connection

Figure 3. Pin connection (top view)

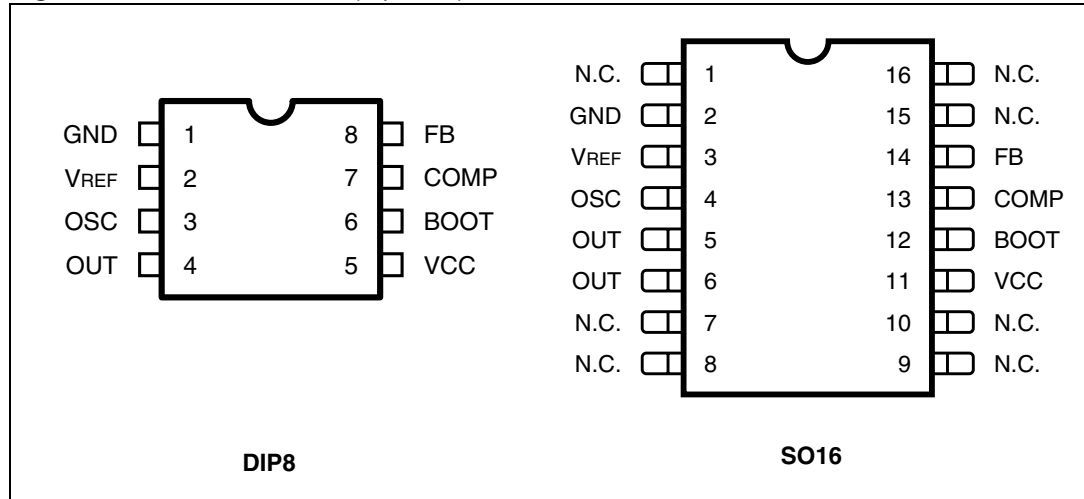

2.2 Pin description

Table 1. Pin description

N° Pin		Name	Description
DIP8	SO16W (1)		
1	2	GND	Ground
2	3	VREF	5.1V Reference voltage with 20mA current capability.
3	4	OSC	An external resistor connected between the unregulated input voltage and this pin and a capacitor connected from this pin to ground fix the switching frequency. (Line feed forward is automatically obtained)
4	5, 6	OUT	Stepdown regulator output.
5	11	VCC	Unregulated DC input voltage.
6	12	BOOT	A capacitor connected between this pin and OUT allows to drive the internal VDMOS.
7	13	COMP	E/A output to be used for frequency compensation.
8	14	FB	Stepdown feedback input. Connecting directly to this pin results in an output voltage of 3.3V. An external resistive divider is required for higher output voltages.

1. Pins 1, 7, 8, 9, 10, 15 and 16 are not internally, electrically connected to the die.

3 Electrical data

3.1 Maximum ratings

Table 2. Absolute maximum ratings

Symbol		Parameter	Value	Unit	
DIP8	S016W				
V5	V11	Input voltage	58	V	
V4	V5, V6	Output DC voltage	-1	V	
		Output peak voltage at $t = 0.1\mu\text{s}$, $f = 200\text{kHz}$	-5	V	
I4	I5, I6	Maximum output current	internal limit		
V6-V5	V12-V11		14	V	
V6	V12	Bootstrap voltage	70	V	
V7	V13	Analogs input voltage ($V_{CC} = 24\text{V}$)	12	V	
V8	V14	$(V_{CC} = 20\text{V})$	6	V	
			-0.3	V	
P_{TOT}		Power dissipation a $T_A \leq 60^\circ\text{C}$	DIP8	1	W
			SO16	0.8	W
T_J, T_{STG}		Junction and storage temperature	-40 to 150	$^\circ\text{C}$	

3.2 Thermal data

Table 3. Thermal data

Symbol	Parameter	DIP8	S016W	Unit
R_{thJA}	Maximum thermal resistance junction-ambient	90 ⁽¹⁾	110 ⁽¹⁾	$^\circ\text{C/W}$

1. Package mounted on board

3.3 Operating temperature rating

Table 4. Operating temperature rating

Symbol	Parameter	Value	Unit
T_J	Junction temperature range	-40 to 150	$^\circ\text{C}$

4 Electrical characteristics

Table 5. Electrical characteristics
 ($T_J = 25^\circ\text{C}$, $C_{OSC} = 2.7\text{nF}$, $R_{OSC} = 20\text{k}\Omega$, $V_{CC} = 24\text{V}$, unless otherwise specified.)

Symbol	Parameter	Test condition	Min	Typ	Max	Unit
Dynamic characteristic						
V_I	Operating input voltage range	$V_O = 3.3$ to 50V ; $I_O = 1\text{A}$ ⁽¹⁾	8		55	V
V_O	Output voltage	$I_O = 0.5\text{A}$	3.33	3.36	3.39	V
		$I_O = 0.2$ to 1A	3.292	3.36	3.427	V
		$V_{CC} = 8$ to 55V ⁽¹⁾	3.22	3.36	3.5	V
V_d	Dropout voltage	$V_{CC} = 10\text{V}$; $I_O = 1\text{A}$		0.29	0.367	V
		⁽¹⁾			0.587	V
I_L	Maximum limiting current	$V_{CC} = 8$ to 55V ⁽¹⁾	1.5	2	2.5	A
	Efficiency	$V_O = 3.3\text{V}$; $I_O = 1\text{A}$		85		%
f_s	Switching frequency	⁽¹⁾	90	100	110	KHz
SVRR	Supply voltage ripple rejection	$V_I = V_{CC} + 2V_{RMS}$; $V_O = V_{ref}$; $I_O = 1\text{A}$; $f_{ripple} = 100\text{Hz}$	60			dB
	Voltage stability of switching frequency	$V_{CC} = 8$ to 55V		3	6	%
	Temp. stability of switching frequency	$T_J = 0$ to 125°C		4		%
Reference section						
	Reference voltage		5.0	5.1	5.2	V
		$I_{ref} = 0$ to 10mA ; ⁽¹⁾ $V_{CC} = 8$ to 55V	4.950	5.1	5.250	V
	Line regulation	$I_{ref} = 0\text{mA}$; $V_{CC} = 8$ to 55V		5	10	mV
		Load regulation	$V_{ref} = 0$ to 5mA ; $V_{CC} = 0$ to 20mA		2	
	Short circuit current		30	65	100	mA

Table 5. Electrical characteristics (continued)

(T_J = 25°C, C_{OSC} = 2.7nF, R_{OSC} = 20kΩ, V_{CC} = 24V, unless otherwise specified.)

Symbol	Parameter	Test condition	Min	Typ	Max	Unit
DC Characteristics						
I _{qop}	Total operating quiescent current			4	6	mA
I _q	Quiescent current	Duty Cycle = 0; V _{FB} = 3.8V		2.5	3.5	mA
Error Amplifier						
V _{FB}	Voltage feedback input		3.33	3.36	3.39	V
R _L	Line regulation	V _{CC} = 8 to 55V		5	10	mV
	Ref. voltage stability vs temperature	(1)		0.4		mV/°C
V _{oH}	High level output voltage	V _{FB} = 2.5V	10.3			V
V _{oL}	Low level output voltage	V _{FB} = 3.8V			0.65	V
I _{O source}	Source output current	V _{comp} = 6V; V _{FB} = 2.5V	180	220		μA
I _{O sink}	Sink output current	V _{comp} = 6V; V _{FB} = 3.8V	200	300		μA
I _b	Source bias current			2	3	μA
SVRR E/A	Supply voltage ripple rejection	V _{comp} = V _{fb} ; V _{CC} = 8 to 55V	60	80		dB
	DC open loop gain	R _L = ∞	50	57		dB
g _m	Transconductance	I _{comp} = -0.1 to 0.1mA V _{comp} = 6V		2.5		ms
Oscillator section						
	Ramp valley		0.78	0.85	0.92	V
	Ramp peak	V _{CC} = 8V	2	2.15	2.3	V
		V _{CC} = 55V	9	9.6	10.2	V
	Maximum duty cycle		95	97		%
	Maximum frequency	Duty cycle = 0% R _{osc} = 13kW, C _{osc} = 820pF			300	kHz

1. Specification referred to T_J from 0 to 125°C

5 Typical characteristics

Figure 4. Quiescent drain current vs. input voltage

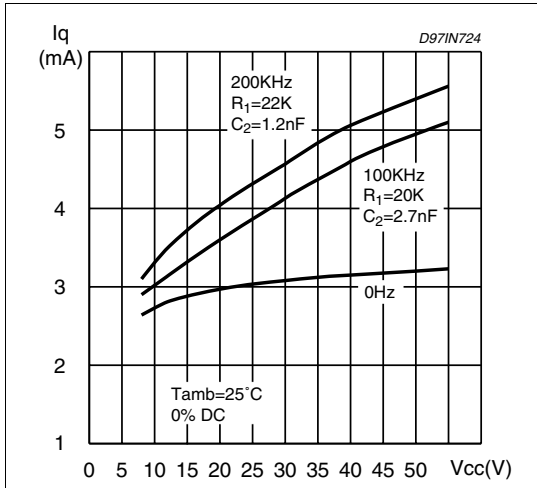

Figure 5. Line regulation

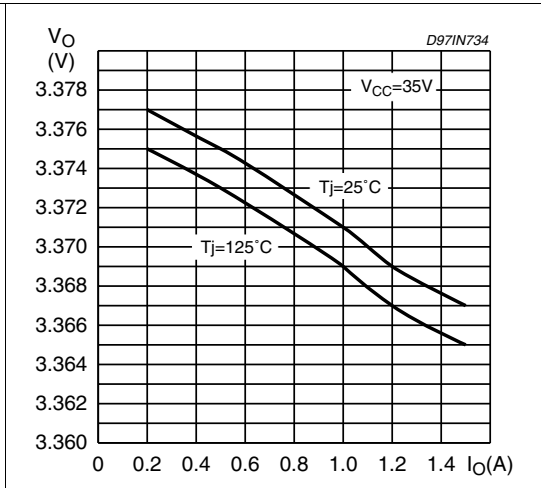

Figure 6. Quiescent current vs. junction temperature

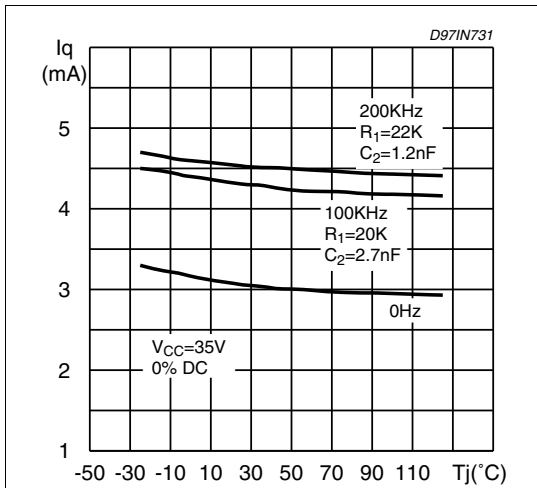

Figure 7. Switching frequency vs. R1 and C2

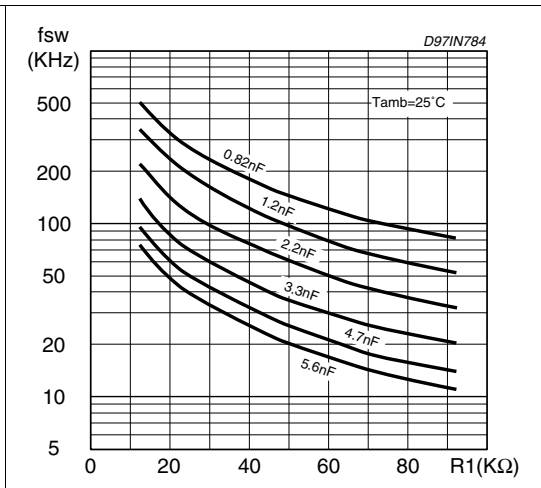

Figure 8. Load regulation

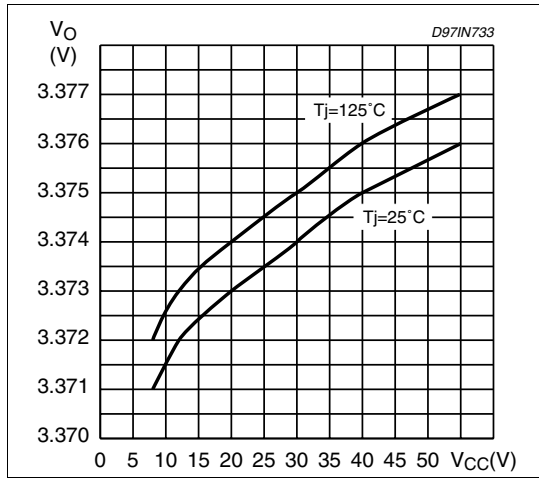

Figure 9. Switching frequency vs. input voltage

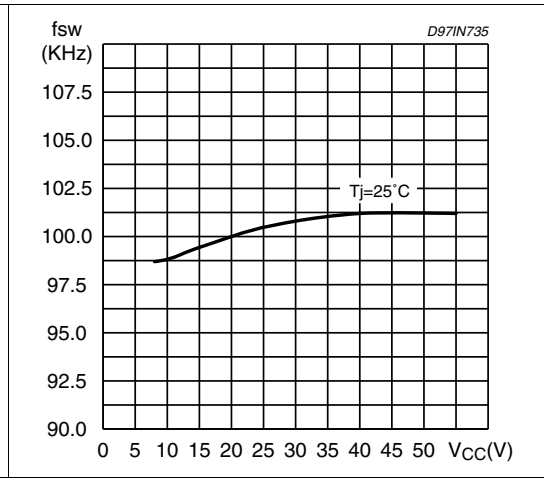

Figure 10. Switching frequency vs. junction temperature

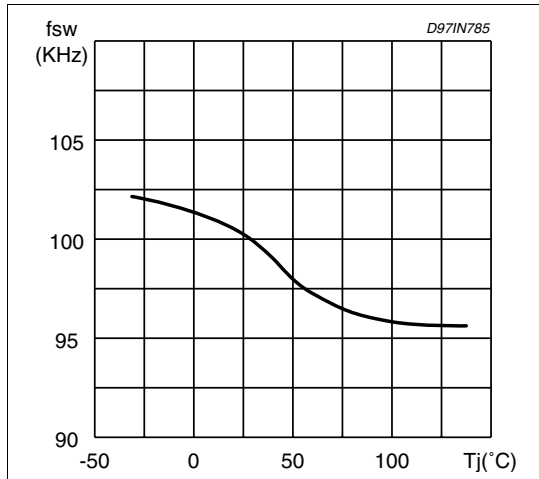

Figure 11. Efficiency vs. output current

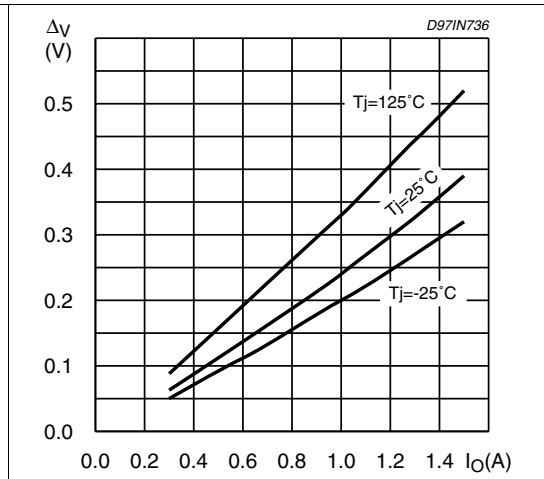

Figure 12. Dropout voltage between pin 5 and 4

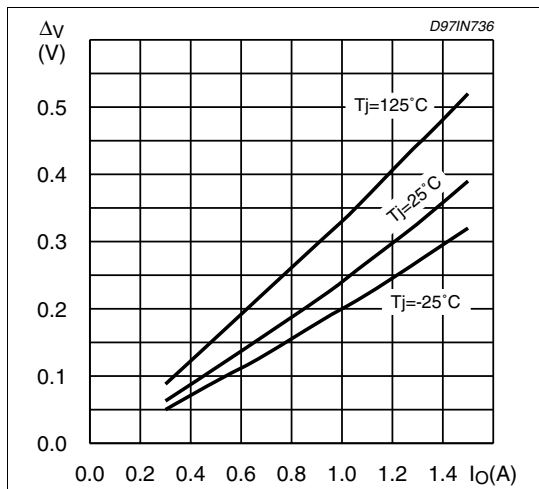

Figure 13. Efficiency vs. output current

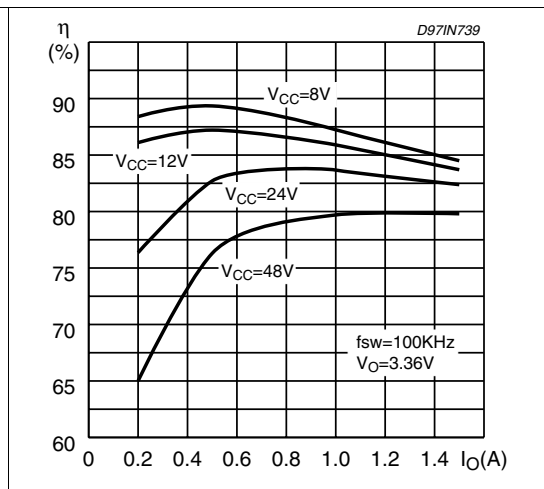

Figure 14. Efficiency vs output voltage

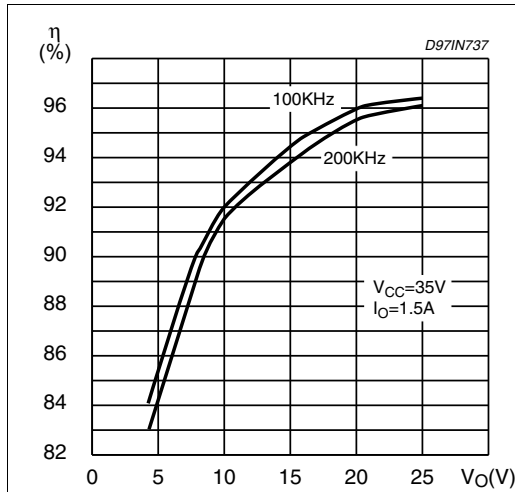

Figure 15. Efficiency vs. output current

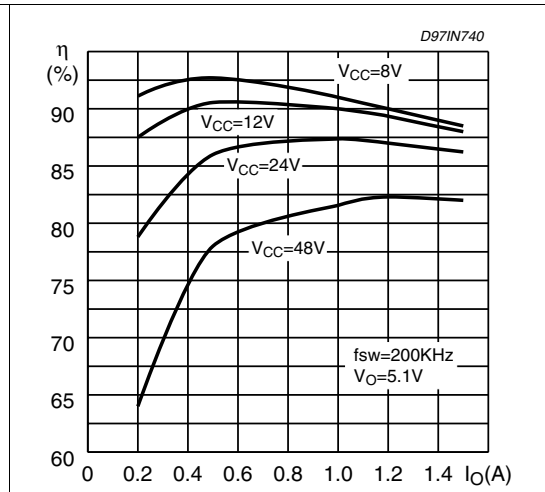

Figure 16. Efficiency vs. output current

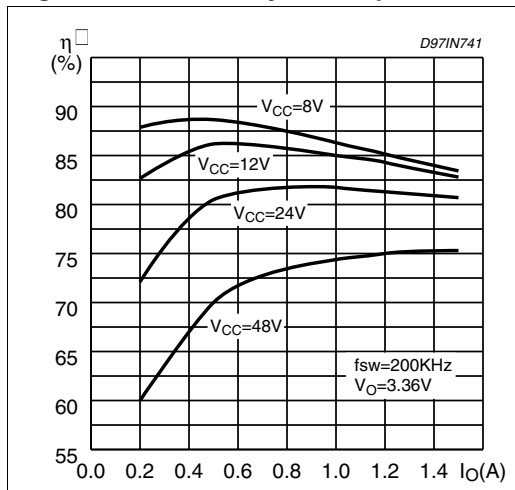

Figure 17. Efficiency vs. Vo

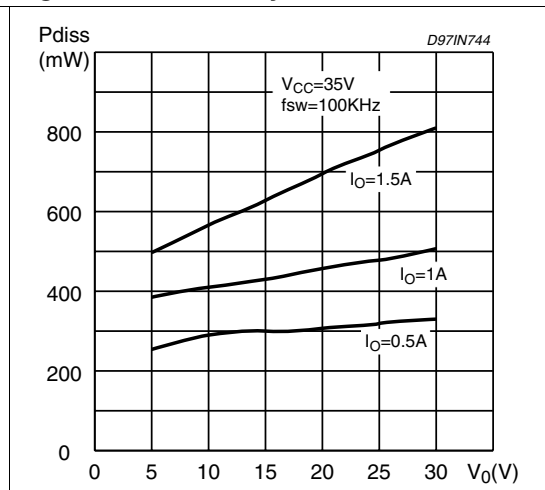

Figure 18. Efficiency vs. VCC

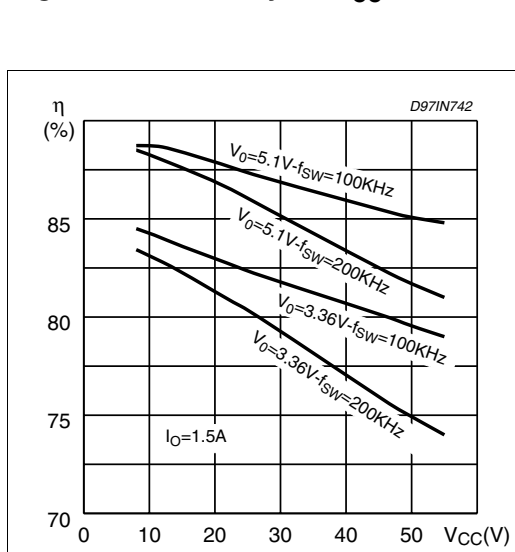

Figure 19. Pulse by pulse limiting current vs. junction temperature.

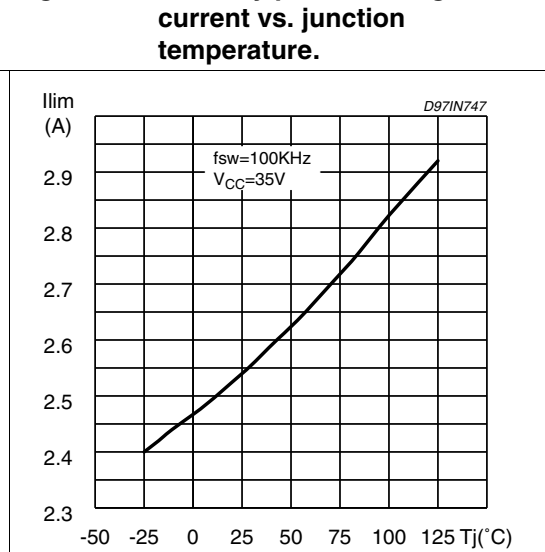

Figure 20. Power dissipation vs. V_{CC}

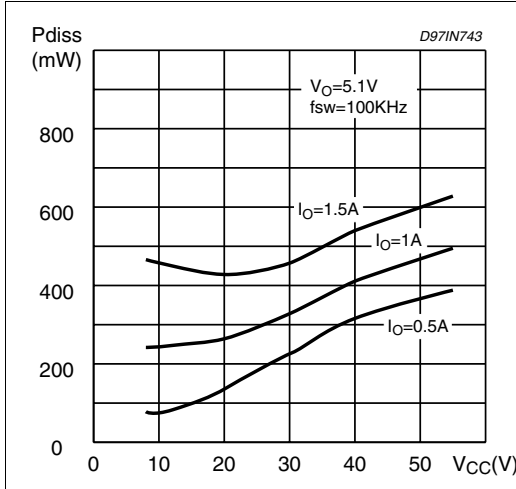

Figure 21. Load transient

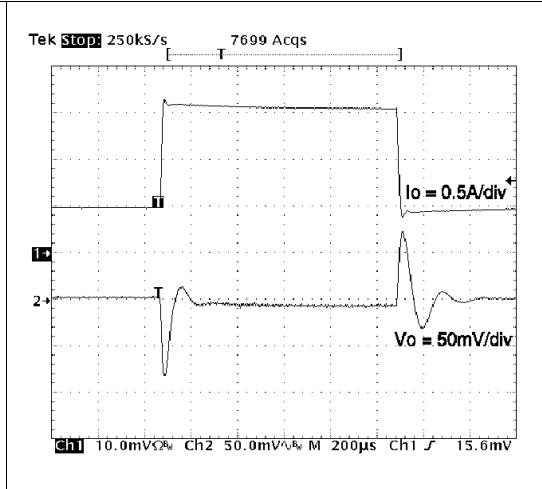

Figure 22. Line transient

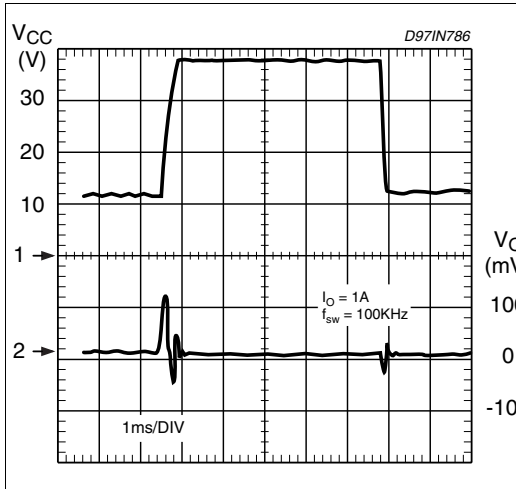
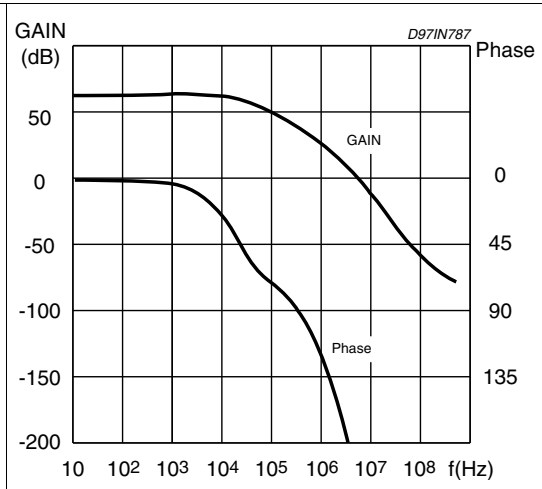

Figure 23. Open loop frequency and phase of error amplifier



6 Package mechanical data

In order to meet environmental requirements, ST offers these devices in ECOPACK® packages. These packages have a Lead-free second level interconnect . The category of second level interconnect is marked on the package and on the inner box label, in compliance with JEDEC Standard JESD97. The maximum ratings related to soldering conditions are also marked on the inner box label. ECOPACK is an ST trademark. ECOPACK specifications are available at: www.st.com

Figure 24. DIP8 mechanical data & package dimensions

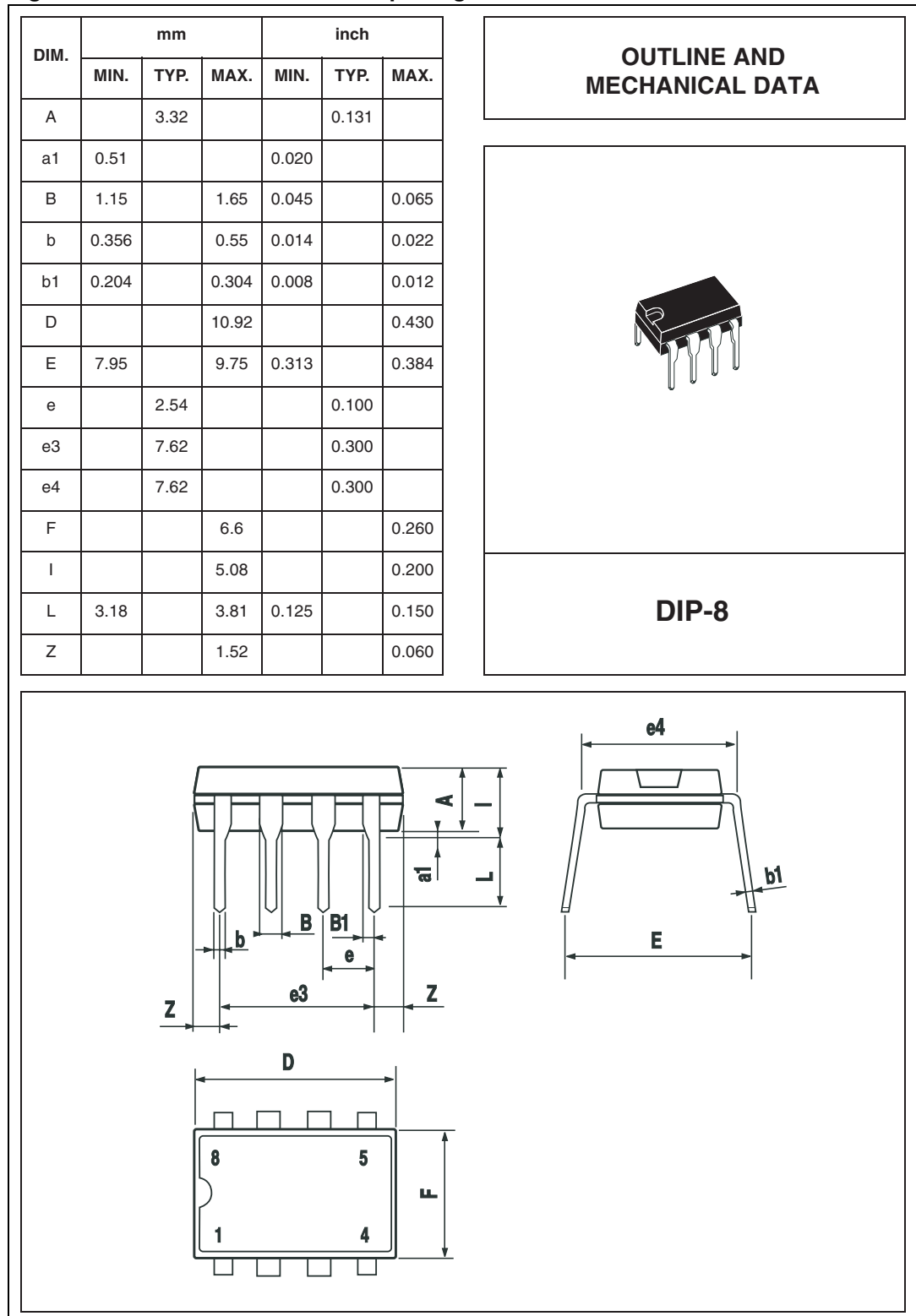
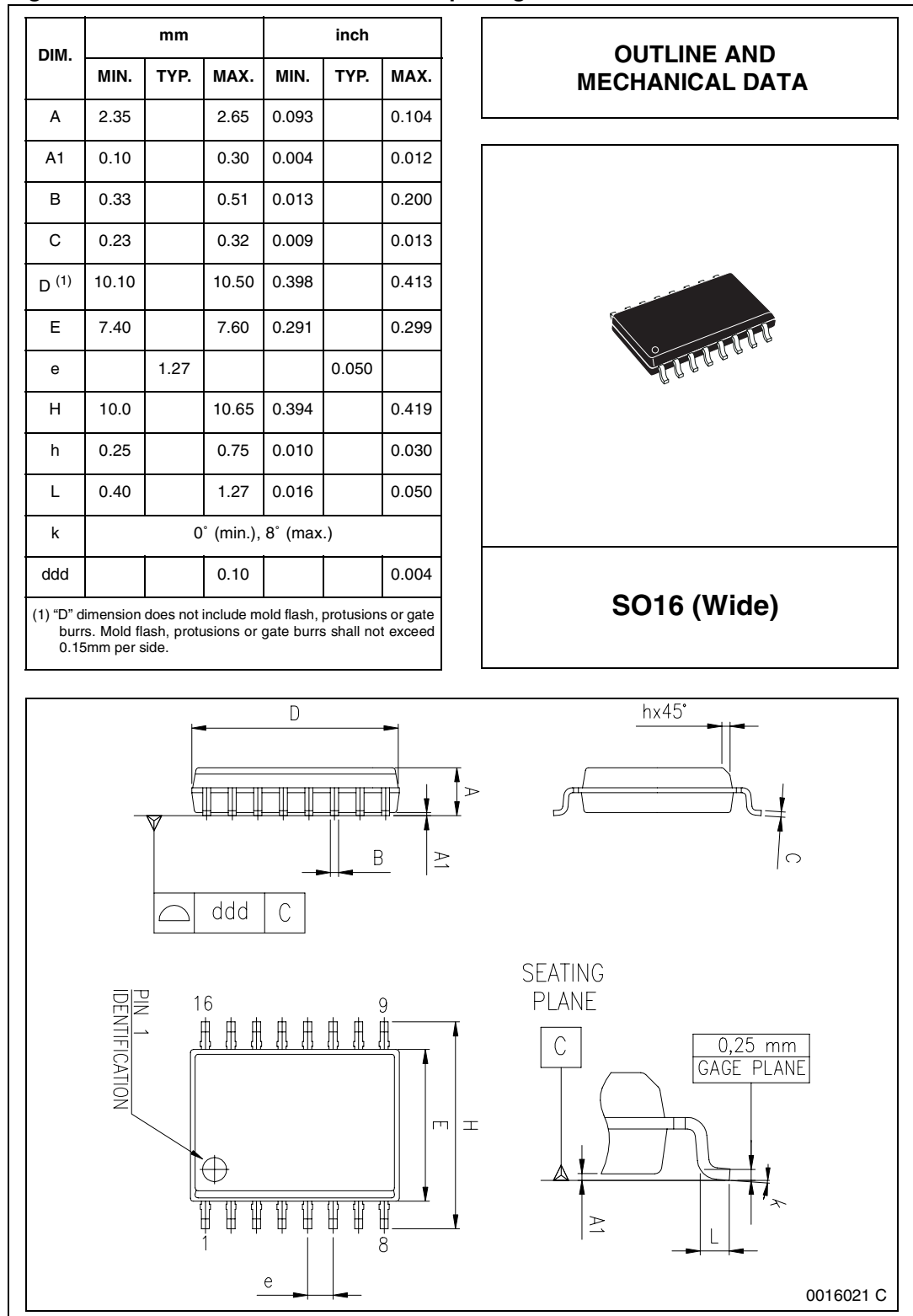

Figure 25. SO16Wide mechanical data & package dimensions



7 Order code

Table 6. Order code

Part number	Package	Packaging
L4976	DIP8	Tube
L4976D	SO16W	Tube
L4976D013TR	SO16W	Tape and reel

8 Revision history

Table 7. Revision history

Date	Revision	Changes
5-Aug-2001	6	First Issue
3-Apr-2007	7	Document reformatted, updated dropout voltage values in Table 5 on page 6

Please Read Carefully:

Information in this document is provided solely in connection with ST products. STMicroelectronics NV and its subsidiaries ("ST") reserve the right to make changes, corrections, modifications or improvements, to this document, and the products and services described herein at any time, without notice.

All ST products are sold pursuant to ST's terms and conditions of sale.

Purchasers are solely responsible for the choice, selection and use of the ST products and services described herein, and ST assumes no liability whatsoever relating to the choice, selection or use of the ST products and services described herein.

No license, express or implied, by estoppel or otherwise, to any intellectual property rights is granted under this document. If any part of this document refers to any third party products or services it shall not be deemed a license grant by ST for the use of such third party products or services, or any intellectual property contained therein or considered as a warranty covering the use in any manner whatsoever of such third party products or services or any intellectual property contained therein.

UNLESS OTHERWISE SET FORTH IN ST'S TERMS AND CONDITIONS OF SALE ST DISCLAIMS ANY EXPRESS OR IMPLIED WARRANTY WITH RESPECT TO THE USE AND/OR SALE OF ST PRODUCTS INCLUDING WITHOUT LIMITATION IMPLIED WARRANTIES OF MERCHANTABILITY, FITNESS FOR A PARTICULAR PURPOSE (AND THEIR EQUIVALENTS UNDER THE LAWS OF ANY JURISDICTION), OR INFRINGEMENT OF ANY PATENT, COPYRIGHT OR OTHER INTELLECTUAL PROPERTY RIGHT.

UNLESS EXPRESSLY APPROVED IN WRITING BY AN AUTHORIZED ST REPRESENTATIVE, ST PRODUCTS ARE NOT RECOMMENDED, AUTHORIZED OR WARRANTED FOR USE IN MILITARY, AIR CRAFT, SPACE, LIFE SAVING, OR LIFE SUSTAINING APPLICATIONS, NOR IN PRODUCTS OR SYSTEMS WHERE FAILURE OR MALFUNCTION MAY RESULT IN PERSONAL INJURY, DEATH, OR SEVERE PROPERTY OR ENVIRONMENTAL DAMAGE. ST PRODUCTS WHICH ARE NOT SPECIFIED AS "AUTOMOTIVE GRADE" MAY ONLY BE USED IN AUTOMOTIVE APPLICATIONS AT USER'S OWN RISK.

Resale of ST products with provisions different from the statements and/or technical features set forth in this document shall immediately void any warranty granted by ST for the ST product or service described herein and shall not create or extend in any manner whatsoever, any liability of ST.

ST and the ST logo are trademarks or registered trademarks of ST in various countries.

Information in this document supersedes and replaces all information previously supplied.

The ST logo is a registered trademark of STMicroelectronics. All other names are the property of their respective owners.

© 2007 STMicroelectronics - All rights reserved

STMicroelectronics group of companies

Australia - Belgium - Brazil - Canada - China - Czech Republic - Finland - France - Germany - Hong Kong - India - Israel - Italy - Japan - Malaysia - Malta - Morocco - Singapore - Spain - Sweden - Switzerland - United Kingdom - United States of America

www.st.com



Mouser Electronics

Authorized Distributor

Click to View Pricing, Inventory, Delivery & Lifecycle Information:

[STMicroelectronics:](#)

[L4976D](#) [L4976](#) [L4976D013TR](#)