

24-Channel Automotive Switch Monitor

General Description

The MAX13362 is a 24-channel automotive contact monitor designed as an interface between mechanical switches and low-voltage processors or other logic circuits. The IC operates over a voltage range of 5.5V to 28V, and withstands voltages up to 40V. It protects low-voltage circuitry from high voltages and reverse battery conditions. The MAX13362's low-current operation under all operating conditions makes it suitable for use in electronic control units (ECUs) that are connected directly to the automotive battery. It has an adjustable scan mode that significantly reduces the current drawn in key-off.

The MAX13362 features an SPI™ interface to monitor the switch status and set the device configuration. Multiple MAX13362s can be cascaded to support any multiple of 24 switches.

The MAX13362 is available in a 6mm x 6mm, 40-pin thin QFN package and operates over the -40°C to +125°C temperature range.

Applications

Automotive Body Controllers
Automotive Door Modules
Automotive Smart Junction Boxes

Typical Application Circuit

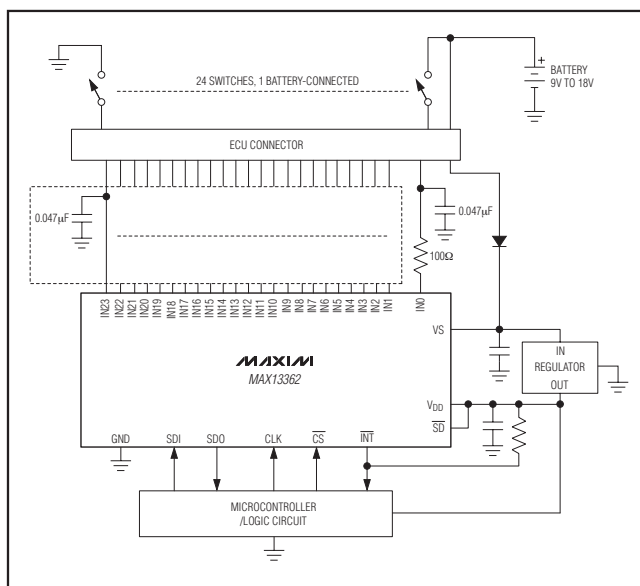

SPI is a trademark of Motorola, Inc.

Features

- ◆ 9V to 18V Operating Voltage Range with Full Performance
- ◆ Fully Functional Range of 5.5V to 28V
- ◆ Switch Inputs Withstand 27V
- ◆ Switch Inputs Withstand Reverse Battery
- ◆ Ultra-Low Operating Current 100µA (typ) in Scan Mode
- ◆ Built-In Switching Hysteresis
- ◆ Built-In Switch Deglitching
- ◆ CMOS-Compatible Logic Outputs Down to 3.0V
- ◆ Interrupt Output to Processor
- ◆ Configurable Wetting Current (0mA, 5mA, 10mA, or 15mA) for Each Switch Input
- ◆ AEC-Q100 Qualified

Ordering Information

PART	TEMP RANGE	PIN-PACKAGE
MAX13362ATLV+	-40°C to +125°C	40 Thin QFN-EP* (6mm x 6mm)

*EP = Exposed pad.

+ Denotes a lead(Pb)-free/RoHS-compliant package.

N Denotes an automotive qualified part.

Pin Configuration

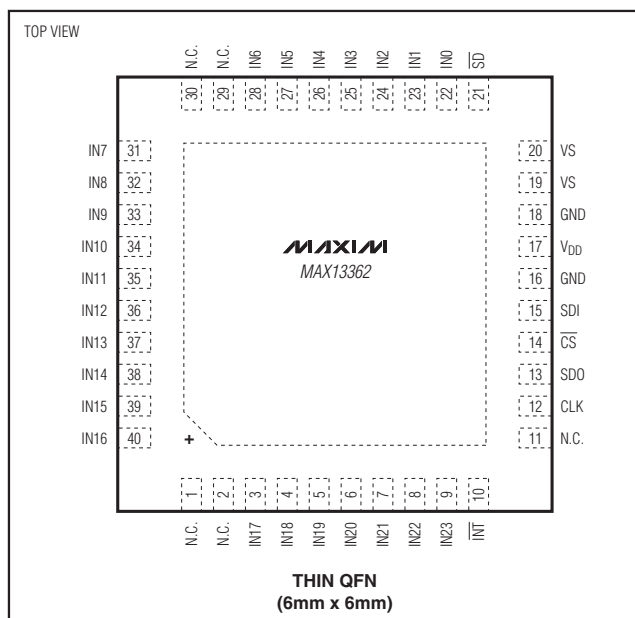

24-Channel Automotive Switch Monitor

ABSOLUTE MAXIMUM RATING

V_{DD} , CLK, SDI, \overline{CS} to GND-0.3V to +6V
 V_S , \overline{SD} , \overline{INT} to GND-0.3V to +40V
 IN_0 – IN_{23} to GND-15V to +27V
 SDO to GND-0.3V to (V_{DD} + 0.3V)
 ESD Protection, All Pins (HBM)±2kV
 ESD Protection on Pins IN_0 – IN_{23} to IEC 61000-4-2 Specification
 (with added 0.047 μ F capacitor, and/or 100 Ω resistor)....±8kV

Current Into Any Pin.....±20mA
 Continuous Power Dissipation ($T_A = +70^\circ\text{C}$)
 (derate 37mW/ $^\circ\text{C}$ above +70 $^\circ\text{C}$)(multilayer board)....2963mW
 Operating Temperature Range-40 $^\circ\text{C}$ to +125 $^\circ\text{C}$
 Junction Temperature.....-40 $^\circ\text{C}$ to +150 $^\circ\text{C}$
 Storage Temperature Range-65 $^\circ\text{C}$ to +150 $^\circ\text{C}$
 Lead Temperature (soldering, 10s)+300 $^\circ\text{C}$

Stresses beyond those listed under "Absolute Maximum Ratings" may cause permanent damage to the device. These are stress ratings only, and functional operation of the device at these or any other conditions beyond those indicated in the operational sections of the specifications is not implied. Exposure to absolute maximum rating conditions for extended periods may affect device reliability.

ELECTRICAL CHARACTERISTICS

($V_{DD} = 5\text{V}$, $V_S = 14\text{V}$, $T_A = -40^\circ\text{C}$ to +125 $^\circ\text{C}$, unless otherwise noted. Typical values are at $T_A = +25^\circ\text{C}$.)

PARAMETER	SYMBOL	CONDITIONS	MIN	TYP	MAX	UNITS
POWER SUPPLY						
V_{DD} Operating Supply Range	V_{DD}		3		5.5	V
V_{DD} Supply Current	I_{DD}			0.1	10	μA
V_S Supply Range	V_S	(Note 1)	5.5		28	V
V_S Undervoltage Lockout	V_{UVLO}		3		5.5	V
Total Supply Current (Flowing into V_S and V_{DD})	I_{SUP}	$t_{POLL} = 64\text{ms}$, $t_{POLL_ACT} = 1\text{ms}$; \overline{LP} bit in internal register = 0, 24 channels active, all switches open, $T_A = +25^\circ\text{C}$		100	170	μA
		$t_{POLL} = 64\text{ms}$, $t_{POLL_ACT} = 1\text{ms}$; \overline{LP} bit in internal register = 0, 24 channels active, all switches open		100	200	
		Continuous polling mode, wetting current set to 5mA		1000		
V_S Supply Current in Shutdown Mode	I_{SDVS}	$\overline{VSD} = 0$, $V_S = 14\text{V}$, all switches open, $T_A = +25^\circ\text{C}$		6	10	μA
V_{DD} Supply Current in Shutdown Mode	I_{SDVDD}	$\overline{VSD} = 0$, $V_S = 14\text{V}$, $T_A = +25^\circ\text{C}$		0.1	5	μA
SWITCH INPUTS						
Input Voltage Threshold	V_{TH}	$V_S = 5.5\text{V}$ to 28V, measured with 100 Ω series resistor for high-side switches	2.5		3.7	V
Input Hysteresis	V_H	$V_S = 5.5\text{V}$ to 28V, measured with 100 Ω series resistor for high-side switches		0.2		V
Wetting Current Rise/Fall Time	t_{WETT}			5		μs
Wetting Current	I_{WETT}	Wetting current set to 15mA, $9\text{V} \leq V_S \leq 18\text{V}$	12.7	15	17.25	mA
		Wetting current set to 15mA, ($5.5\text{V} \leq V_S < 9\text{V}$) or ($18\text{V} < V_S \leq 28\text{V}$)	10.5	15	19.5	
IN_0 – IN_{23} Input Current	$I_{IN_}$	$V_{IN_} = 0$, $T_A = +25^\circ\text{C}$			2	μA
		$V_{IN_} = 14\text{V}$, $T_A = +25^\circ\text{C}$ (Note 2)		16	30	
IN_0 – IN_{23} Input Leakage Current in Shutdown	I_{LEAKSD}	$V_S = 0$ or 14V, $\overline{VSD} = 0$, $T_A = +25^\circ\text{C}$			±2	μA
IN_4 – IN_{23} Dropout Voltage	V_{DO15}	$I_{WETT} = 15\text{mA}$ (Note 3)		2.8	4.0	V

24-Channel Automotive Switch Monitor

MAX13362

ELECTRICAL CHARACTERISTICS (continued)

($V_{DD} = 5V$, $V_{VS} = 14V$, $T_A = -40^{\circ}C$ to $+125^{\circ}C$, unless otherwise noted. Typical values are at $T_A = +25^{\circ}C$.)

PARAMETER	SYMBOL	CONDITIONS	MIN	TYP	MAX	UNITS
LOGIC LEVELS						
\overline{INT} Output-Voltage Low	V_{OLINT}	Sinking 1mA			0.4	V
SDO Output-Voltage Low	V_{OLSDO}	Sinking 1mA			$0.2 \times V_{DD}$	V
SDO Output-Voltage High	V_{OHSDO}	Sourcing 1mA	$0.8 \times V_{DD}$			V
SDO Leakage Current in High-Impedance Mode	I_{LSDO}	$\overline{VCS} = 5V$	-1		+1	μA
SDI, CLK, \overline{CS} Input-Voltage Low	V_{IL}				$0.33 \times V_{DD}$	V
SDI, CLK, \overline{CS} Input-Voltage High	V_{IH}		$0.66 \times V_{DD}$			V
\overline{SD} Input Low Voltage	V_{ILSD}		0.8			V
\overline{SD} Input High Voltage	V_{IHSD}				2.4	V
SDI Internal Pulldown Resistor	R_{PD}		30	50	120	$k\Omega$
CLK Pin Leakage	$I_{LEAKCLK}$	$V_{CLK} = 5V$, $T_A = +25^{\circ}C$			1	μA
\overline{CS} Pin Leakage	I_{LEAKCS}	$\overline{VCS} = 5V$, $T_A = +25^{\circ}C$			1	μA
\overline{SD} Pin Leakage	I_{LEAKSD}	$\overline{VSD} = 5V$, $T_A = +25^{\circ}C$			1	μA
\overline{INT} Pin Leakage	$I_{LEAKINT}$	$\overline{VINT} = \text{high impedance}$, $T_A = +25^{\circ}C$			1	μA
THERMAL SHUTDOWN						
Thermal Shutdown Threshold	T_{SHDN}	Temperature rising (Note 4)	+150	+165		$^{\circ}C$
Thermal Shutdown Hysteresis	T_{HYST}			15		$^{\circ}C$
TIMING						
Switch Inputs Deglitching Time	t_{GT}		37	50	63	μs
CLK Frequency Range	f_{CLK}	(Note 4)	0.01		4	MHz
Falling Edge of \overline{CS} to Rising Edge of CLK Setup Time	t_{LEAD}	Polling mode, input rise/fall time < 10ns (Note 4)	100			ns
Falling Edge of CLK to Rising Edge of \overline{CS} Setup Time	t_{LAG}	Input rise/fall time < 10ns (Note 4)	100			ns
SDI-to-CLK Falling Edge Setup Time	$t_{SI(SU)}$	(Note 4)	30			ns
SDI Hold Time After Falling Edge of CLK	$t_{SI(HOLD)}$	(Note 4)	20			ns
Time from Rising Edge of CLK to SDO Data Valid	t_{VALID}	$C_{SDO} = 50pF$ (Note 3)			70	ns
Time from Falling Edge of \overline{CS} to SDO Low Impedance	$t_{SO(EN)}$	(Note 4)			55	ns
Time from Rising Edge of \overline{CS} to SDO High Impedance	$t_{SDO(DIS)}$	(Note 4)			55	ns

24-Channel Automotive Switch Monitor

ELECTRICAL CHARACTERISTICS (continued)

($V_{DD} = 5V$, $V_{VS} = 14V$, $T_A = -40^{\circ}C$ to $+125^{\circ}C$, unless otherwise noted. Typical values are at $T_A = +25^{\circ}C$.)

PARAMETER	SYMBOL	CONDITIONS	MIN	TYP	MAX	UNITS
Polling Active Time Accuracy	t_{POLL_ACT}		-20		+20	%
Polling Time Accuracy	t_{POLL}		-20		+20	%
Time from Shutdown to Normal Operation	t_{START}			0.1	1	ms

Note 1: When V_{VS} is above 28V, the wetting current is disabled to limit power dissipation, and the switch inputs are not monitored. When V_{VS} returns, there is a 1ms blanking time before the external switches are polled.

Note 2: This current only flows during the polling active time thus the average value is much lower. For example with a polling time of 64ms and a polling active time of 1ms the average current on an input when connected to 14V is typically $16\mu A \times 1/64 = 0.25\mu A$.

Note 3: Difference between V_S and $IN_$ voltage when wetting current has dropped to 90% of its nominal value.

Note 4: Guaranteed by design.

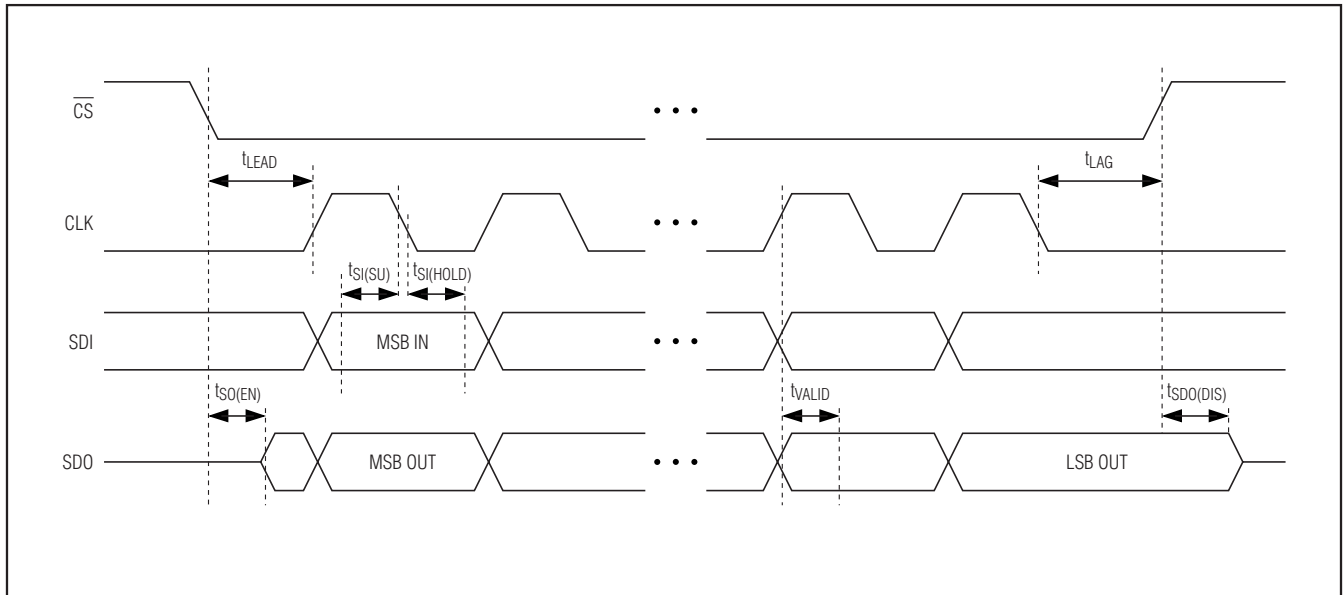

Figure 1. SPI Timing Characteristics

24-Channel Automotive Switch Monitor

Typical Operating Characteristics

($V_{DD} = \sqrt{SD} = 5V$, $V_{VS} = 14V$, $T_A = +25^\circ C$, unless otherwise noted.)

MAX13362

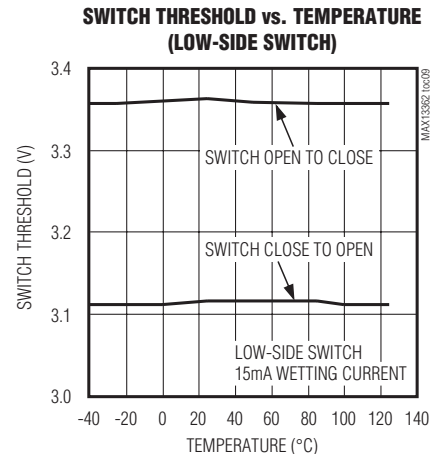
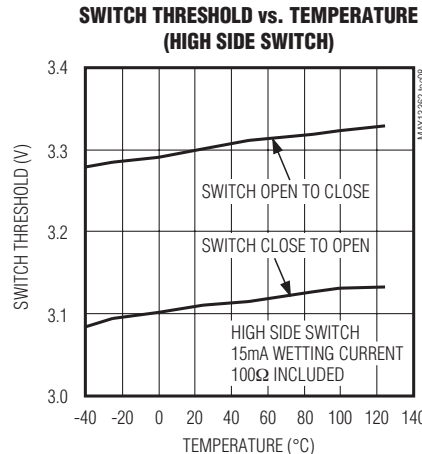
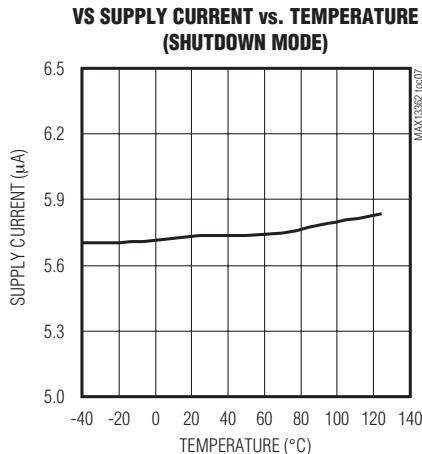
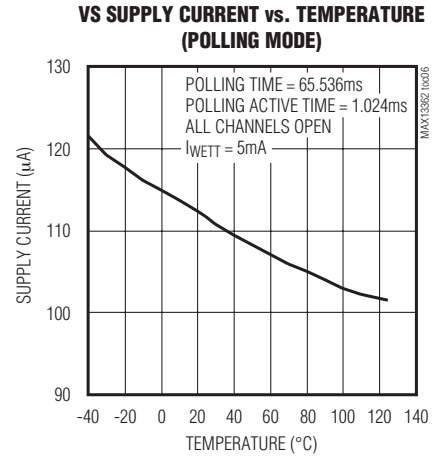
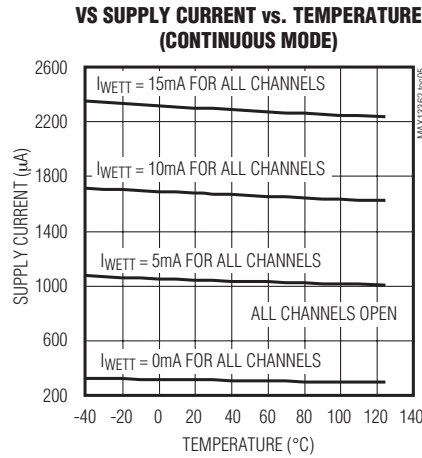
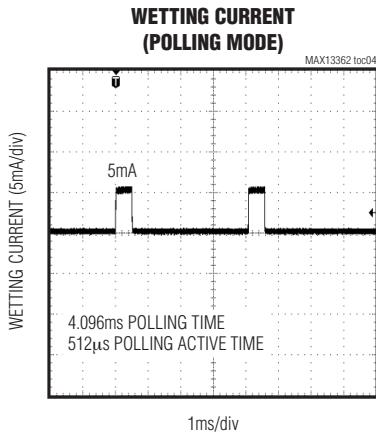
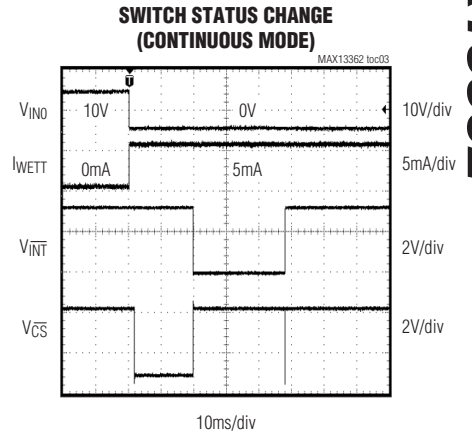
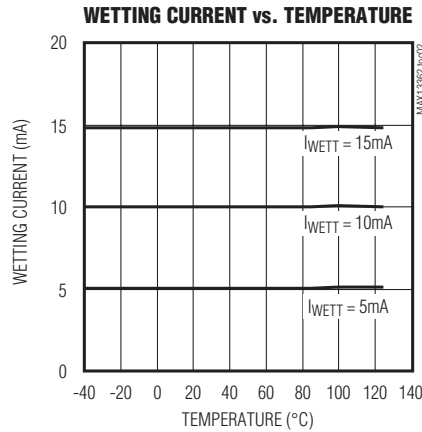
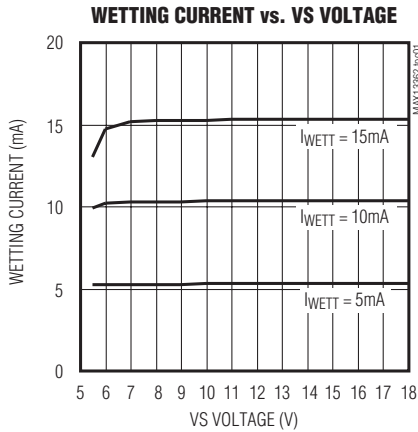

24-Channel Automotive Switch Monitor

Typical Operating Characteristics (continued)

($V_{DD} = V_{SD} = 5V$, $V_{VS} = 14V$, $T_A = +25^\circ C$, unless otherwise noted.)

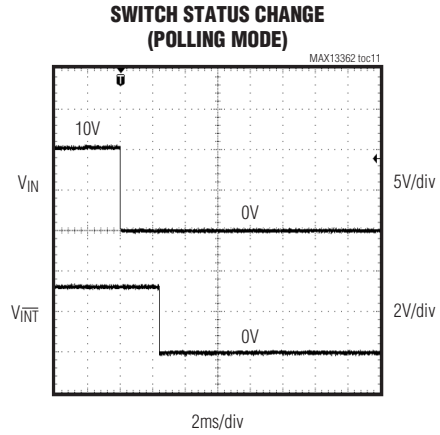
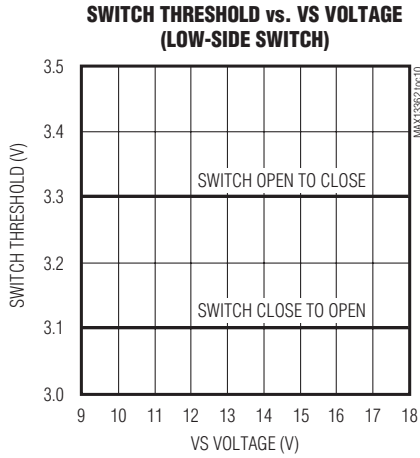

Pin Description

PIN	NAME	FUNCTION
1, 2, 11, 29, 30	N.C.	No Connection. Not internally connected.
3	IN17	Switch Monitor Input Channel 17. Connect IN17 to a ground-connected switch.
4	IN18	Switch Monitor Input Channel 18. Connect IN18 to a ground-connected switch.
5	IN19	Switch Monitor Input Channel 19. Connect IN19 to a ground-connected switch.
6	IN20	Switch Monitor Input Channel 20. Connect IN20 to a ground-connected switch.
7	IN21	Switch Monitor Input Channel 21. Connect IN21 to a ground-connected switch.
8	IN22	Switch Monitor Input Channel 22. Connect IN22 to a ground-connected switch.
9	IN23	Switch Monitor Input Channel 23. Connect IN23 to a battery-connected or ground-connected switch. When used for a battery-connected switch, add a 100Ω series protection resistor to the input.
10	\overline{INT}	Interrupt Output. \overline{INT} is an open-drain output that asserts low when one or more of the inputs (IN0–IN23) change state and are enabled for interrupts, or when the overtemperature threshold is exceeded.
12	CLK	SPI Serial Clock Input
13	SDO	SPI Serial Data Output. SPI data is output on SDO on the rising edges of CLK while \overline{CS} is held low. SDO is high impedance when \overline{CS} is high. Connect SDO to a microcontroller data input or to a succeeding device in a daisy chain.
14	\overline{CS}	SPI Chip-Select Input. Drive \overline{CS} low to enable clocking of data into and out of the IC. SPI data is latched into the device on the rising edge of \overline{CS} .
15	SDI	SPI Serial Data Input. SPI data is latched into the internal shift register on the falling edges of CLK while \overline{CS} is held low. SDI has an internal 50kΩ pulldown resistor. Connect SDI to the SDO of a preceding device in a daisy chain or to the microcontroller data output.
16, 18	GND	Ground. Pins 16 and 18 must be connected to ground.
17	V_{DD}	Logic Supply Voltage. Connect V_{DD} to a 3.3V or 5V logic supply. Bypass V_{DD} to GND with at least a 0.1μF capacitor placed as close as possible to V_{DD} .

24-Channel Automotive Switch Monitor

Pin Description (continued)

MAX13362

PIN	NAME	FUNCTION
19, 20	VS	Supply Voltage Input. VS should be protected from reverse battery using a series diode. Bypass VS to GND with a 0.1µF ceramic capacitor placed as close as possible to VS. In addition, bypass VS with a 47µF or greater capacitor.
21	\overline{SD}	Shutdown Input. Drive \overline{SD} low to place the IC into shutdown mode. Drive \overline{SD} high for normal operation. \overline{SD} is battery-voltage compatible.
22	IN0	Switch Monitor Input Channel 0. Connect IN0 to a battery-connected or ground-connected switch. When used for a battery-connected switch, add a 100Ω series protection resistor to the input.
23	IN1	Switch Monitor Input Channel 1. Connect IN1 to a battery-connected or ground-connected switch. When used for a battery-connected switch, add a 100Ω series protection resistor to the input.
24	IN2	Switch Monitor Input Channel 2. Connect IN2 to a battery-connected or ground-connected switch. When used for a battery-connected switch, add a 100Ω series protection resistor to the input.
25	IN3	Switch Monitor Input Channel 3. Connect IN3 to a battery-connected or ground-connected switch. When used for a battery-connected switch, add a 100Ω series protection resistor to the input.
26	IN4	Switch Monitor Input Channel 4. Connect IN4 to a ground-connected switch.
27	IN5	Switch Monitor Input Channel 5. Connect IN5 to a ground-connected switch.
28	IN6	Switch Monitor Input Channel 6. Connect IN6 to a ground-connected switch.
31	IN7	Switch Monitor Input Channel 7. Connect IN7 to a ground-connected switch.
32	IN8	Switch Monitor Input Channel 8. Connect IN8 to a ground-connected switch.
33	IN9	Switch Monitor Input Channel 9. Connect IN9 to a ground-connected switch.
34	IN10	Switch Monitor Input Channel 10. Connect IN10 to a ground-connected switch.
35	IN11	Switch Monitor Input Channel 11. Connect IN11 to a ground-connected switch.
36	IN12	Switch Monitor Input Channel 12. Connect IN12 to a ground-connected switch.
37	IN13	Switch Monitor Input Channel 13. Connect IN13 to a ground-connected switch.
38	IN14	Switch Monitor Input Channel 14. Connect IN14 to a ground-connected switch.
39	IN15	Switch Monitor Input Channel 15. Connect IN15 to a ground-connected switch.
40	IN16	Switch Monitor Input Channel 16. Connect IN16 to a ground-connected switch.
—	EP	Exposed Pad. Connect EP to GND for enhanced thermal performance.

24-Channel Automotive Switch Monitor

Functional Diagram

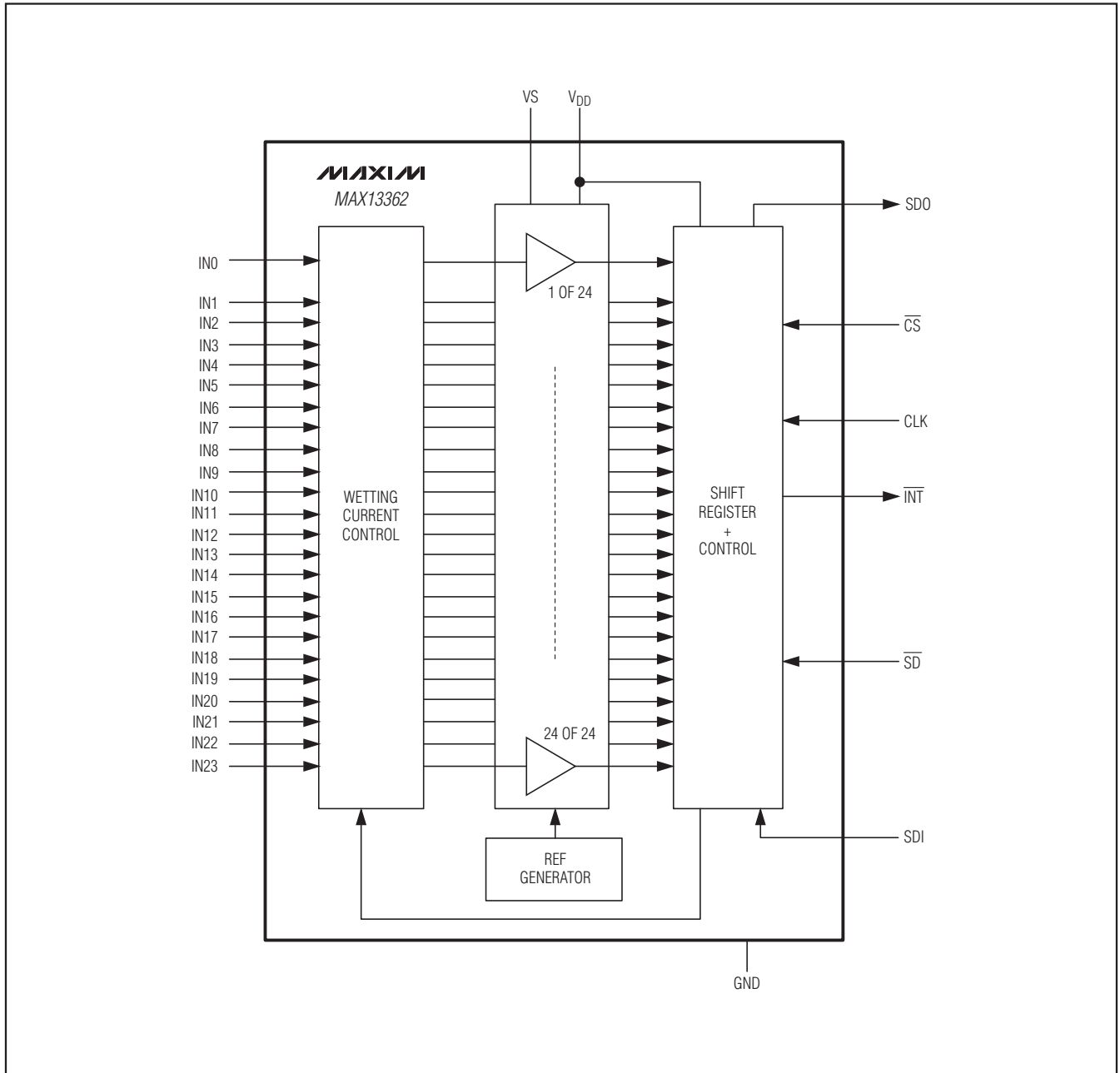

24-Channel Automotive Switch Monitor

Detailed Description

The MAX13362 is a 24-channel automotive contact monitor designed as an interface between mechanical switches and low-voltage microcontrollers or other logic circuits. It features an SPI interface to monitor individual switch inputs and to configure interrupt capability, wetting current, switch configuration (battery-connected or ground-connected), polling time and polling active time. Any switch status change will cause an interrupt signal if the switch is interrupt enabled. The MAX13362 has three modes of operation: continuous mode, polling mode, and shutdown mode.

V_{DD} and V_S

V_{DD} is the power-supply input for the logic input/output circuitry. Connect V_{DD} to a 3V to 5.5V logic-level supply. Bypass V_{DD} to GND with at least a 0.1μF capacitor placed as close as possible to V_{DD}.

V_S is the main power-supply input. Bypass V_S to GND with a 0.1μF ceramic capacitor placed as close as possible to V_S. In addition, bypass V_S with a 47μF or greater capacitor.

Mechanical Switch Inputs (IN0–IN23)

IN0–IN23 are the inputs for remote mechanical switches. The switch status is indicated by the S0–S23 bits in the status register, and each switch input can be programmed to assert an interrupt ($\overline{\text{INT}}$) by writing to the IE0–IE23 bits in the command register. All switch inputs are interrupt disabled upon power-up.

The IN4–IN22 inputs are intended for ground-connected switches. The IN0–IN3 and IN23 inputs can be programmed for either ground-connected switches or

battery-connected switches by writing to the LH0–LH3 and LH23 bits (see Table 2). The default configuration of the IN0–IN3 and IN23 inputs after power-up is for ground-connected switches.

Wetting Current

The MAX13362 applies a programmable wetting current to any closed switch to clean switch contacts that are exposed to adverse conditions. The wetting current for each switch can be set to 0mA, 5mA, 10mA, or 15mA by the W_0 and W_1 data bits in the command registers (see Table 5) by means of an SPI data transaction.

When using wetting current, special care must be taken to avoid exceeding the maximum power dissipation of the MAX13362 (see the *Applications Information* section). Disabling the wetting current or limiting the active-wetting current time reduces power consumption. The default state upon power-up is with wetting current disabled.

Interrupt Output ($\overline{\text{INT}}$)

$\overline{\text{INT}}$ is an active-low, open-drain output that asserts low when any of the switch inputs change state and is enabled for interrupts, or when the overtemperature threshold is exceeded. An external pullup resistor to V_{DD} is needed on $\overline{\text{INT}}$. $\overline{\text{INT}}$ is cleared when $\overline{\text{CS}}$ is driven low for a read/write operation. However, in polling mode, any switch state change or overtemperature change which occurs during an SPI transaction is stored and causes an additional interrupt after the SPI transaction is over and $\overline{\text{CS}}$ goes high (shown in Figure 2).

If V_{DD} is absent, the $\overline{\text{INT}}$ output is functional provided that it is pulled up to a different supply voltage.

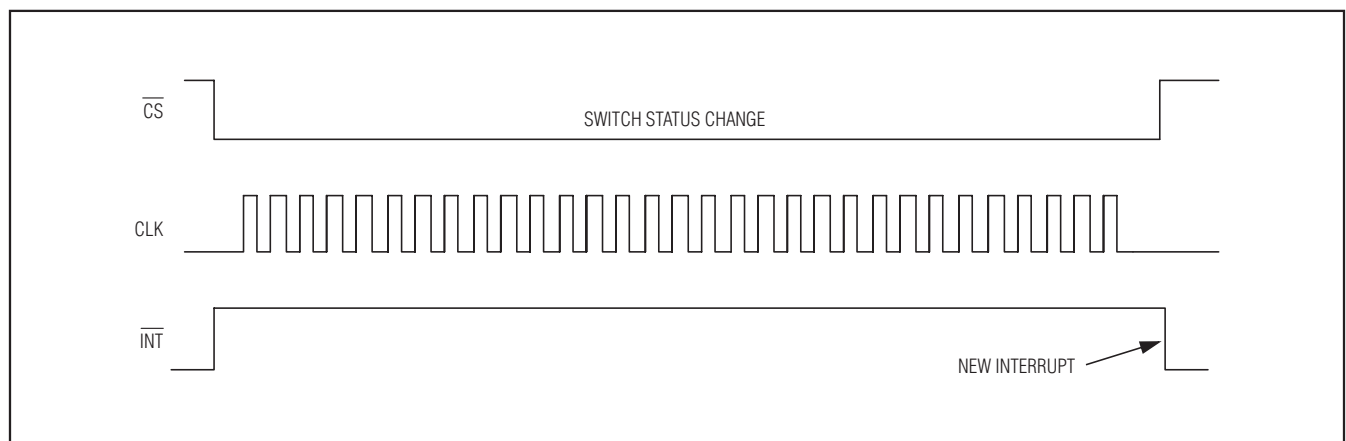

Figure 2. Switch State Change During the SPI transaction

24-Channel Automotive Switch Monitor

Serial Peripheral Interface (CS, SDO, SDI, CLK)

The MAX13362 operates as a serial peripheral interface (SPI) slave device. An SPI master accesses and programs the MAX13362 by reading/writing the control registers. The control registers are 32 bits wide, have 2 command bits (or register addresses) and 30 data bits (see Table 1). Figure 3 shows the read/write sequence through SPI. The SPI logic counts the number of bits clocked into the IC (using a modulo-32 counter so that

daisy chaining is possible) and enables data latching only if exactly 32 bits (or an integer multiple thereof) have been clocked in.

Status Register

The status register contains the status of the switches connected to IN0–IN23. The status register also contains an overtemperature warning bit, a power-on-reset bit and a device type bit (see Table 1). The status register is accessed by the SPI-compatible interface.

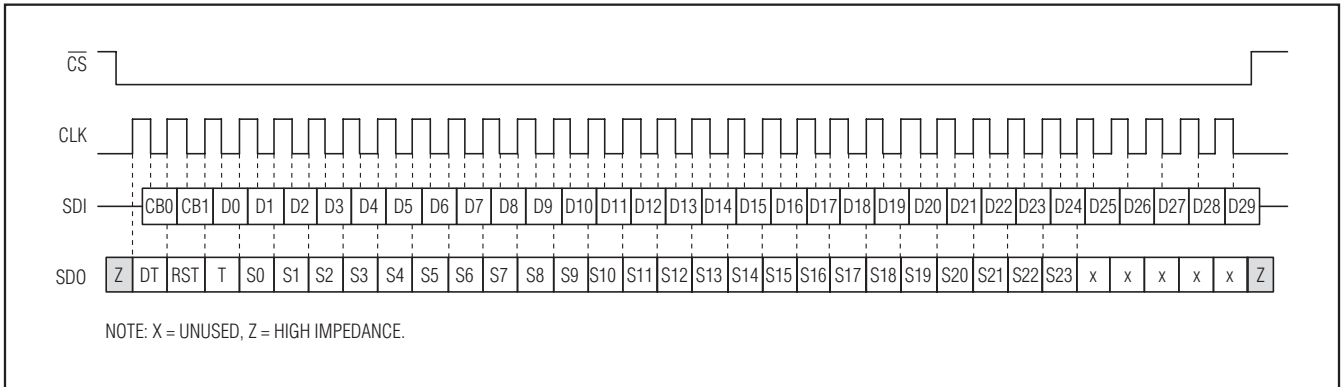

Figure 3. SPI Read/Write Sequence

Table 1. Bit Description

BIT NAME	BIT DESCRIPTION
CB0, CB1	Command bits. Select the internal register to which data bits D0–D29 are to be written.
D0–D29	Data bits.
S0–S23	Switch state bit. 0 = switch open, 1 = switch closed.
T	Overtemperature bit. When overtemperature occurs, this bit is set to 1. It is reset on the rising edge of \overline{CS} .
RST	Power-on-reset bit. It indicates whether the IC has had a power-on-reset since the last SPI read. 0 = device has been reset. RST is set to 1 on the rising edge of \overline{CS} .
DT	Device type. 0 = reserved for future use, 1 = MAX13362.

24-Channel Automotive Switch Monitor

Command Register

Three 32-bit command registers are used to configure the MAX13362 for various modes of operation and are accessed by the SPI-compatible interface (see Table 2).

The default configuration after power-on is LH_n = 0, ground connected.

Table 2. Command Register Map

D29	D28	D27	D26	D25	D24	D23	D22	D21	D20	D19	D18	D17	D16	D15	D14	D13	D12	D11	D10	D9	D8	D7	D6	D5	D4	D3	D2	D1	D0	CB1	CB0
X	LP	PA2	PA1	PA0	W23 0	W22 0	W21 .0	W20 .0	W19 .0	W18 .0	W17 .0	W16 0	W15 .0	W14 .0	W13 .0	W12 .0	W11 .0	W10 .0	W9 0	W8 0	W7 0	W6 0	W5 0	W4 0	W3 0	W2 0	W1 0	W0 0	X	0	0
X	P3	P2	P1	P0	W23 1	W22 1	W21 .1	W20 .1	W19 .1	W18 .1	W17 .1	W16 1	W15 .1	W14 .1	W13 .1	W12 .1	W11 .1	W10 .1	W9 1	W8 1	W7 1	W6 1	W5 1	W4 1	W3 1	W2 1	W1 1	W0 1	X	0	1
LH2 3	LH3	LH2	LH1	LH0	IE23	IE22	IE21	IE20	IE19	IE18	IE17	IE16	IE15	IE14	IE13	IE12	IE11	IE10	IE9	IE8	IE7	IE6	IE5	IE4	IE3	IE2	IE1	IE0	X	1	0
NO OPERATION (NO DATA WRITTEN)																														1	1

LH_n: Switch Configuration for IN0–IN3 and IN23

The LH0–LH3 and LH23 bits set the switch configuration for IN0–IN3 and IN23, respectively. Set LH_n to 0 to configure the input channel to ground connected. Set LH_n to 1 to configure the input channel to battery connected.

P0–P3: Polling Time

P0–P3 are used to set the polling time as shown in Table 3.

PA0–PA2: Polling Active Time

PA0–PA2 are used to set the polling active time as shown in Table 4.

Table 3. Polling Time Setting

P3	P2	P1	P0	POLLING TIME (ms)
0	0	0	0	Continuous*
0	0	0	1	4.096
0	0	1	0	4.096
0	0	1	1	4.096
0	1	0	0	4.096
0	1	0	1	4.096
0	1	1	0	8.192
0	1	1	1	16.384
1	0	0	0	32.768
1	0	0	1	65.536
1	0	1	0	131
1	0	1	1	262.1
1	1	0	0	524.3
1	1	0	1	1049
1	1	1	0	2097
1	1	1	1	4194

*Default POR value.

Table 4. Polling-Active Time Setting

PA2	PA1	PA0	POLLING ACTIVE TIME (μs)
0	0	0	64
0	0	1	128
0	1	0	256
0	1	1	512*
1	0	0	1024
1	0	1	2048
1	1	0	4096
1	1	1	4096

*Default POR Value.

24-Channel Automotive Switch Monitor

IE₋: Interrupt Enable

The IE₋ bit programs the switch input channel, IN₋, to be interrupt-enabled or interrupt-disabled (0 = interrupt disabled, 1 = interrupt enabled). The default value after power-on is 0.

W₋₀ and W₋₁: Wetting Current

W₋₀ and W₋₁ bits set the corresponding switch channel-wetting current as shown in Table 5.

Table 5. Wetting Current Setting

W ₋₁	W ₋₀	WETTING CURRENT (mA)
0	0	0*
0	1	5
1	0	10
1	1	15

*Default POR value.

LP: Low Quiescent Current Bit

In polling mode, when LP is set to 0, the IC is operating with the lowest quiescent current. The channels that are not enabled to interrupt have their wetting current disabled and are not monitored. The first pulse of wetting current after the switch is closed and sampled is 5mA unless the wetting current for that channel is set to 0mA. The default value of LP after power-on is 0. When LP is 1, all channels are monitored and the wetting current for each channel is set to the value determined by W₋₀ and W₋₁. If the MAX13362 is in continuous mode, LP is ignored.

Operating Modes

The MAX13362 features three modes of operation: continuous mode, polling mode, and shutdown mode. In continuous mode, the wetting currents (if enabled) are continuously applied to the closed switches. In polling mode, the wetting currents are applied to the closed

switches for a preset duration to reduce the power consumption. In shutdown mode, all switch inputs are high impedance and all circuitry is shutdown.

Continuous Mode Operation (P0–P3 = 0)

In continuous mode, reading of the switch status is initiated by a falling edge on CS. The microcontroller initiates a low pulse on CS to update the MAX13362 switch status register. If INT remains high, no action needs be taken by the microcontroller. If INT goes low, the microcontroller may perform a read operation to read the updated switch status. On the rising edge of CS, INT is updated. To get correct data, the microcontroller must wait 10μs before initiating a switch status read operation. (See Figure 4.)

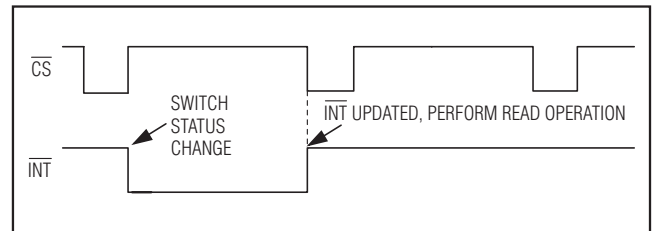

Figure 4. Continuous Mode Operation

Polling-Mode Operation

In polling mode (see Figure 5), each switch input is sampled for a programmable polling active time set by the PA0–PA2 bits between 64μs and 4ms (see Table 4). Sampling is repeated at a period set by the P0–P3 bits (from 4ms to continuous, see Table 3). All switch inputs are sampled simultaneously at the end of the polling active time. Wetting currents (if enabled) are applied to closed switches during the polling active time. Therefore, the polling mode reduces the current consumption from the VS power supply to some value dependent on the polling time chosen.

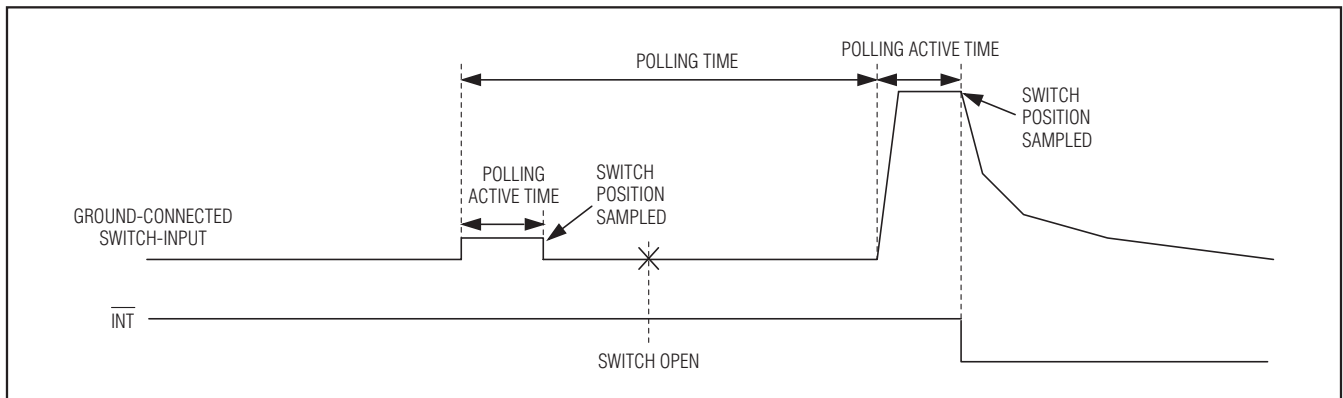

Figure 5. Switch Sampling in Polling Mode

24-Channel Automotive Switch Monitor

MAX13362

Any switch position change (if the switch is interrupt-enabled) is signaled through the active-low open-drain $\overline{\text{INT}}$ output. The $\overline{\text{INT}}$ output is cleared when $\overline{\text{CS}}$ goes low.

Shutdown Mode

In shutdown mode, all switch inputs are high impedance and the external switches are no longer monitored, reducing current consumption on VS to $6\mu\text{A}$ (typ). The IC resets upon entering shutdown mode and the contents of the command registers are lost. Therefore, any setting other than power-on-reset defaults needs to be reprogrammed after exiting from the shutdown mode.

Applications Information

Overtemperature Protection

If the IC junction temperature exceeds $+165^\circ\text{C}$, an interrupt signal is generated and the wetting currents are disabled to reduce the on-chip power dissipation. During an overtemperature event, the last switch status is retained in internal memory and the switch status is not updated. The interrupt output is cleared when $\overline{\text{CS}}$ goes high, but the overtemperature bit T in the output word remains for as long as the overtemperature condition persists. When the junction temperature drops by 15°C , the wetting currents are re-enabled and there is a 1ms blanking time before the switches can be polled.

Reverse-Battery Tolerance

The IN0–IN23 switch inputs withstand up to -15V DC voltage without damage. A reverse-battery diode is needed to protect VS as shown in the *Typical Application Circuit*. $\overline{\text{SD}}$ can be controlled from a bat-

tery-level source but should be protected against reverse battery in the application.

Wetting Current and Power Dissipation

The maximum power dissipation happens when all switch inputs configured with 15mA continuous wetting current are all closed. Assuming the battery voltage is 14V, the corresponding power dissipated by the IC is $24 \times 14\text{V} \times 15\text{mA} = 5040\text{mW}$. This exceeds the absolute maximum power dissipation of 2963mW. In polling mode, the wetting currents are pulsed at the programmed polling time to reduce the total power dissipated in the IC.

ISO 7637 Pulse Immunity

VS , $\overline{\text{SD}}$, and IN0–IN23 are potentially exposed to ISO 7637 pulses. Bypass VS with a $0.1\mu\text{F}$ and a $47\mu\text{F}$ capacitor. The VS and $\overline{\text{SD}}$ voltage must be limited below 40V during load dump. Bypass IN0–IN23 with at least $0.047\mu\text{F}$ capacitors at the ECU connector. When IN0–IN3 or IN23 inputs are used with battery-connected switches, a 100Ω series resistor is needed. These external components allow VS , $\overline{\text{SD}}$, and IN0–IN23 to withstand ISO 7637 pulses in the application circuit.

Mechanical Switch Characteristics

The MAX13362 is designed to operate with switches that have the following characteristics:

- 1) Minimum resistance value with switch open (due to leakage): $10\text{k}\Omega$.
- 2) Maximum resistance value with switch closed: 100Ω .

Chip Information

PROCESS: BiCMOS

24-Channel Automotive Switch Monitor

Package Information

For the latest package outline information and land patterns, go to www.maxim-ic.com/packages.

PACKAGE TYPE	PACKAGE CODE	DOCUMENT NO.
40 TQFN-EP	T4066+5	21-0141

Maxim cannot assume responsibility for use of any circuitry other than circuitry entirely embodied in a Maxim product. No circuit patent licenses are implied. Maxim reserves the right to change the circuitry and specifications without notice at any time.

14 **Maxim Integrated Products, 120 San Gabriel Drive, Sunnyvale, CA 94086 408-737-7600**

Mouser Electronics

Authorized Distributor

Click to View Pricing, Inventory, Delivery & Lifecycle Information:

[Maxim Integrated:](#)

[MAX13362ATL/V+](#) [MAX13362ATL/V+T](#)