



- Rectangular caps
- Rocker-action pushbutton cap
- 12.5 mm x 10.1 mm; 18.65 mm x 10.1 mm; 25.0 mm x 10.1 mm
- h = 12.2 mm
- Material: ABS/polycarbonate
- Temp. Range:
  - Solid cap: -40/+65°C
  - Transparent cap: -40/+85°C
- Panel cut-out: 1A/1H-13.0 x 10.5, 1M-25.7 x 10.5, 1ZA-19.4x10.5

All dimensions in mm

Tolerances +/-0.2mm

### DIMENSIONS

#### SMD w/LED + 1A

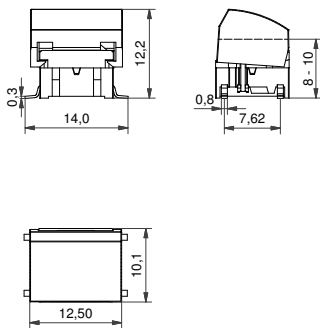

#### TH w/LED + 1H

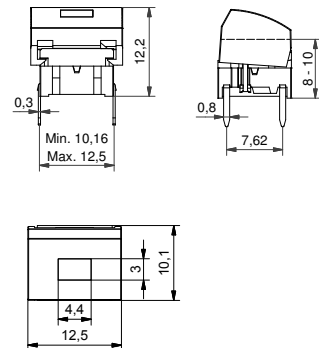

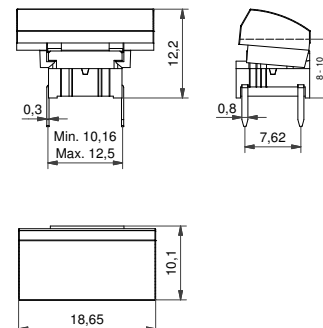

#### TH + 1ZA

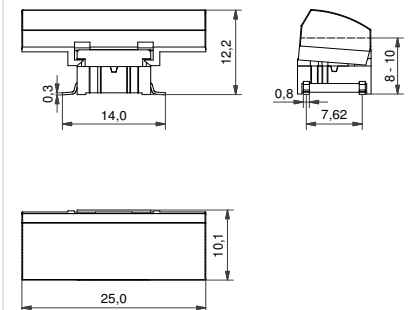

#### SMD + 1M





### ILLUMINATED – HOW TO ORDER

| Switch     | Mounting   | Actuation force                                   | LED  | + | Cap  | Colour code 1H  | Lens 1H   |
|------------|--|---|--|---|--|---|---|
| <b>5 G</b> | <input type="checkbox"/> <input type="checkbox"/> <input type="checkbox"/> | <input type="checkbox"/> <input type="checkbox"/> | <input type="checkbox"/> <input type="checkbox"/> <input type="checkbox"/>   |   | <input type="checkbox"/> <input type="checkbox"/>  | <input type="checkbox"/> <input type="checkbox"/>   | <input type="checkbox"/>  |
|            | <b>TH9</b> through-hole<br><b>SH9</b> surface mount                        | <b>20</b><br><b>35</b><br><b>65</b><br><b>Q*</b>  | <b>02</b> blue<br><b>22</b> green<br><b>42</b> yellow<br><b>61</b> white<br><b>82</b> red<br><b>2242</b> green/yellow<br><b>8222</b> red/green<br><b>8242</b> red/yellow |   | <b>1H</b><br><br><b>1A</b><br> | <b>03</b> grey<br><b>09</b> black<br><br><u>Colour code 1A</u><br><b>16</b> frosted white | <b>1</b> transparent<br><b>2</b> green<br><b>4</b> yellow<br><b>6</b> frosted white<br><b>8</b> red |

\*For an illuminated quiet 2.0N switch add Q to the end of the switch part number.

### NON-ILLUMINATED – HOW TO ORDER

| Switch     | Mounting   | Actuation force                                   | + | Cap   | Colour code 1A/1M  | Colours 1ZA:  |
|------------|--|---|---|---|--|---|
| <b>5 G</b> | <input type="checkbox"/> <input type="checkbox"/> <input type="checkbox"/> | <input type="checkbox"/> <input type="checkbox"/> |   | <input type="checkbox"/> <input type="checkbox"/> <input type="checkbox"/>  | <input type="checkbox"/> <input type="checkbox"/>  |   |
|            | <b>TH9</b> through-hole<br><b>SH9</b> surface mount                        | <b>20</b><br><b>20Q</b><br><b>35</b><br><b>65</b> |   | <b>1A</b><br><br><b>1ZA</b><br><br><b>1M</b><br> | <b>00</b> blue<br><b>02</b> green<br><b>03</b> grey<br><b>04</b> yellow<br><b>06</b> white<br><b>08</b> red<br><b>09</b> black | <b>03</b> grey<br><b>06</b> white<br><b>09</b> black<br><b>30</b> ultra blue<br><b>40</b> dusty blue<br><b>42</b> aqua blue<br><b>50</b> metal dark blue<br><b>53</b> metal light grey<br><b>57</b> metal dark grey<br><b>58</b> metal bordeaux |

Ordering example:

5GSH93582 + 1H098 with illumination OR 5GTH965 + 1ZA57 without illumination OR \*5GTH92001Q (illuminated quiet version).























Please see colour codes, updates of products and changes of specifications on [www.mec.dk](http://www.mec.dk)

|          |      |   |       |   |      |   |        |   |       |   |      |   |       |   |
|----------|------|---|-------|---|------|---|--------|---|-------|---|------|---|-------|---|
| No.      | 00   |  | 02    |  | 03   |  | 04     |  | 06    |  | 08   |  | 09    |  |
| Colour   | blue |   | green |   | grey |   | yellow |   | white |   | red  |   | black |   |
| RAL Code | 5012 |   | 6018  |   | 7004 |   | 1023   |   | 9010  |   | 3000 |   | 9004  |   |

|          |            |   |            |   |           |   |       |   |           |   |            |   |           |   |
|----------|------------|---|------------|---|-----------|---|-------|---|-----------|---|------------|---|-----------|---|
| No.      | 30         |  | 32         |  | 33        |  | 34    |  | 38        |  | 40         |  | 42        |  |
| Colour   | ultra blue |   | mint green |   | tele grey |   | melon |   | noble red |   | dusty blue |   | aqua blue |   |
| RAL Code | 5002       |   | 6029       |   | 7046      |   | 1028  |   | 3002      |   | 5014       |   | 5021      |   |

## Metallic Colours

|          |             |   |             |   |             |   |             |   |
|----------|-------------|---|-------------|---|-------------|---|-------------|---|
| No.      | 50          |  | 53          |  | 57          |  | 58          |  |
| Colour   | dark blue   |   | light grey  |   | dark grey   |   | bordeaux    |   |
| RAL Code | No Ral Code |   | No Ral Code |   | No Ral Code |   | No Ral Code |   |

| CAP CODE       |   | 00 | 02 | 03 | 04 | 06 | 08 | 09 | 30 | 32 | 33 | 34 | 38 | 40 | 42 | 50 | 53 | 57 | 58 |
|----------------|---|----|----|----|----|----|----|----|----|----|----|----|----|----|----|----|----|----|----|
| 1A             |  | •  | •  | •  | •  | •  | •  | •  |    |    |    |    |    |    |    |    |    |    |    |
| 1B             |  | •  | •  | •  | •  | •  | •  | •  |    |    |    |    |    |    |    |    |    |    |    |
| 1C             |  |    |    | •  |    |    | •  | •  |    |    |    |    |    |    |    |    |    |    |    |
| 1DS            |  | •  | •  | •  | •  | •  | •  | •  | •  | •  | •  | •  | •  | •  | •  | •  | •  | •  | •  |
| 1ES/1FS        |  | •  | •  | •  | •  | •  | •  | •  |    |    |    |    |    |    |    |    |    |    |    |
| 1GAS/1GCS      |  | •  | •  | •  | •  | •  | •  | •  |    |    |    |    |    |    |    |    |    |    |    |
| 1H             |  |    |    | •  |    |    |    | •  |    |    |    |    |    |    |    |    |    |    |    |
| 1JS            |  | •  | •  | •  | •  | •  | •  | •  |    |    |    |    |    |    |    |    |    |    |    |
| 1KS            |  | •  | •  | •  | •  | •  | •  | •  |    |    |    |    |    |    |    |    |    |    |    |
| 1M             |  | •  | •  | •  | •  | •  | •  | •  |    |    |    |    |    |    |    |    |    |    |    |
| 1NS            |  |    |    | •  |    |    |    | •  |    |    |    |    |    |    |    |    |    |    |    |
| 1PS            |  | •  | •  | •  | •  | •  | •  | •  |    |    |    |    |    |    |    |    |    |    |    |
| 1QS/1RS        |  | •  |    | •  |    |    |    | •  |    |    |    |    |    |    |    |    |    |    |    |
| 1SS/1LS        |  | •  | •  | •  | •  | •  | •  | •  |    |    |    |    |    |    |    |    |    |    |    |
| 1TS/1US/1VS    |  | •  |    | •  |    |    |    | •  | •  |    |    |    |    |    |    |    |    |    |    |
| 1WAS/1WDS/1WPS |  | •  |    | •  |    |    |    | •  | •  | •  |    |    |    | •  | •  |    | •  | •  |    |
| 1XS            |  | •  | •  | •  | •  | •  | •  | •  |    |    |    |    |    |    |    |    |    |    |    |
| 1ZA            |  |    |    | •  |    | •  |    | •  | •  |    |    |    |    | •  | •  | •  | •  | •  | •  |
| 1ZB            |  |    |    | •  |    | •  |    | •  | •  |    |    |    |    | •  | •  | •  | •  | •  | •  |
| 1ZCS           |  |    |    | •  |    | •  |    | •  | •  | •  |    |    |    | •  | •  | •  | •  | •  | •  |
| 1Z/1ZW         |  | •  |    | •  |    | •  |    | •  |    |    |    |    |    |    |    |    |    |    |    |
| 10R/10RF + 10Q |  | •  | •  | •  | •  | •  | •  | •  |    |    |    |    |    |    |    |    |    |    |    |



- Through-hole (TH) or surface mount (SMD)
- 50mA/24VDC
- Single pole/momentary
- 10,000,000 operations lifetime (NO function)
- Temperature range:
  - Switch: -40/+160°C
  - LED: -40/+85°C
- IP 67 sealing
- Actuation force: 2.0N, 3.5N, 6.5N
- NO or NC/NO

All dimensions in mm

Tolerances +/-0.2mm

### THROUGH-HOLE (TH)

5G

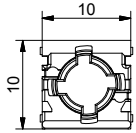
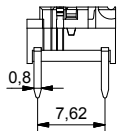
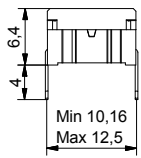

5G illuminated

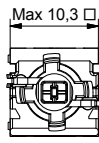
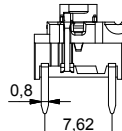
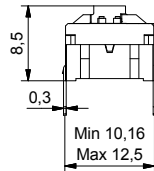

5E

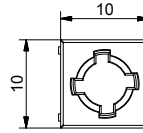
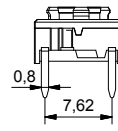
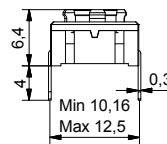

### PCB LAYOUT

Non-illuminated

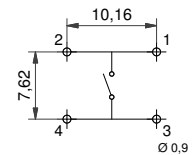

1 LED

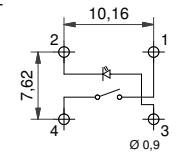

2 LED

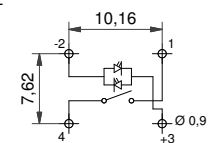

### SURFACE MOUNT (SMD)

5G

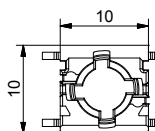
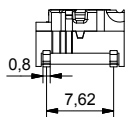
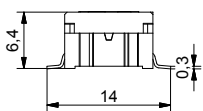

5G illuminated

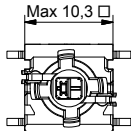
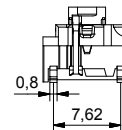
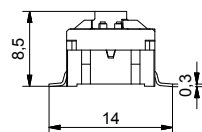

5E

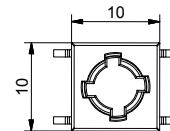
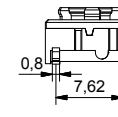
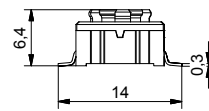

### PCB LAYOUT

Non-illuminated

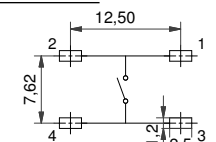

1 LED

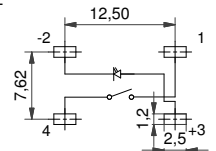

2 LED

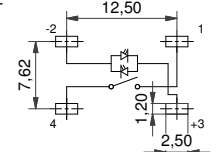

### NORMALLY CLOSED/NORMALLY OPEN FUNCTION

### NOT FOR SALE IN JAPAN

### CIRCUIT DIAGRAM

- Available for 5E and non-illuminated 5G in 3.5N actuation force.
- Same PCB layout as the NO 5E and 5G
- Housing colour is **grey**

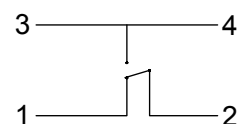

### RIGHT ANGLE SWITCHES

### PCB LAYOUT

5E

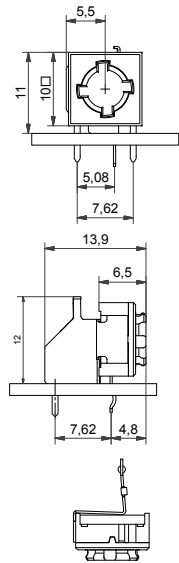

5G

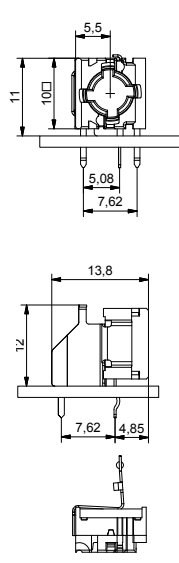

5G + 1SS

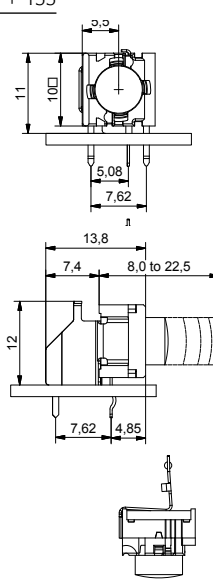

5G + 1DS

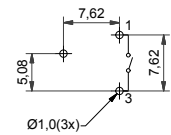
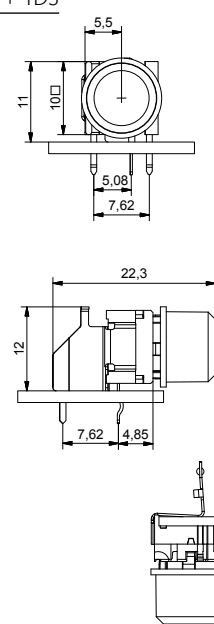

multimec® 5 series has only normally open (NO) non-illuminated right angle switch.

### ILLUMINATED – HOW TO ORDER

| Switch     | Mounting   | Actuation force  | LED  | Quiet (optional)          |
|------------|--|--|--|---------------------------|
| <b>5 G</b> | <input type="checkbox"/> <input type="checkbox"/> <input type="checkbox"/> | <input type="checkbox"/> <input type="checkbox"/> <input type="checkbox"/> | <input type="checkbox"/> <input type="checkbox"/> <input type="checkbox"/>                   | <input type="checkbox"/>  |
|            | <b>TH9</b> through-hole<br><b>SH9</b> surface mount                        | <b>20</b><br><b>35</b><br><b>65</b>  | <b>02</b> blue<br><b>22</b> green<br><b>42</b> yellow<br><b>61</b> white                     | <b>Q</b><br>only for 2.0N |
|            |  |  | <b>82</b> red<br><b>2242</b> green/yellow<br><b>8222</b> red/green<br><b>8242</b> red/yellow |                           |

### NON-ILLUMINATED – HOW TO ORDER

| Switch     | Mounting   | Actuation force  | RAS (optional)   | or                       | NC/NO (only for 3.5N)   |
|------------|--|--|--|--------------------------|---|
| <b>5 E</b> | <input type="checkbox"/> <input type="checkbox"/> <input type="checkbox"/> | <input type="checkbox"/> <input type="checkbox"/> <input type="checkbox"/> | <input type="checkbox"/> <input type="checkbox"/> <input type="checkbox"/> | <input type="checkbox"/> | <input type="checkbox"/> <input type="checkbox"/> <input type="checkbox"/> <input type="checkbox"/> |
|            | <b>TH9</b> through-hole<br><b>SH9</b> surface mount                        | <b>20</b><br><b>20Q</b><br><b>35</b><br><b>65</b>                          | <b>RAS</b> right angle switch  |                          | <b>NCNO</b> normally closed/<br>normally open function  |

| Switch     | Mounting   | Actuation force  | RAS (optional)   | or                       | NC/NO (only for 3.5N)   |
|------------|--|--|--|--------------------------|---|
| <b>5 G</b> | <input type="checkbox"/> <input type="checkbox"/> <input type="checkbox"/> | <input type="checkbox"/> <input type="checkbox"/> <input type="checkbox"/> | <input type="checkbox"/> <input type="checkbox"/> <input type="checkbox"/> | <input type="checkbox"/> | <input type="checkbox"/> <input type="checkbox"/> <input type="checkbox"/> <input type="checkbox"/> |
|            | <b>TH9</b> through-hole<br><b>SH9</b> surface mount                        | <b>20</b><br><b>20Q</b><br><b>35</b><br><b>65</b>                          | <b>RAS</b> right angle switch  |                          | <b>NCNO</b> normally closed/<br>normally open function  |

Ordering example: 5ESH935 (non-illuminated), 5GTH9658222 (illuminated), 5GSH935NCNO (normally closed/normally open); 5ETH920RAS (right angle) 5ETH920Q or 5GSH92061Q (quiet versions)

Please see colour codes, updates of products and changes of specifications on [www.mec.dk](http://www.mec.dk)

### Basic switch spacing

through-hole (TH)

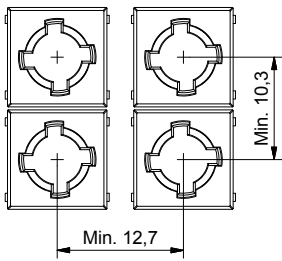

surface mount (SMD)

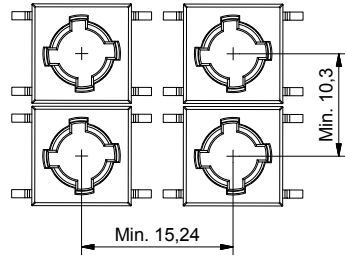

### Recommended switch/cap spacing

Switch spacing

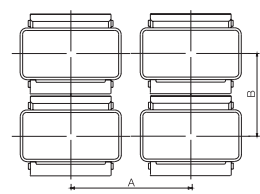

Cap dimensions

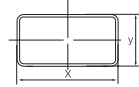

Panel cut-out

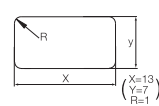

### Panel cut-out

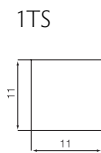
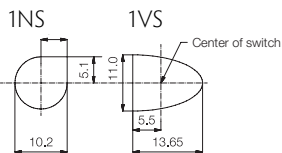

### Spacing examples

multimec  
5GT+1B/C+2C/D

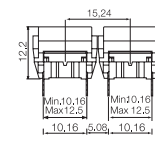

multimec  
5GS+1B/C+2C/D

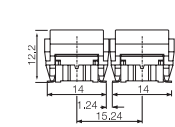

multimec  
5GT + 1A/H

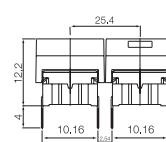

multimec  
5GT + 1M

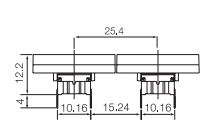

multimec  
1NS + 1NS + 1NS

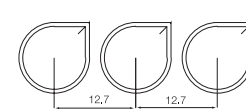

multimec  
1VS + 1TS+ 1VS

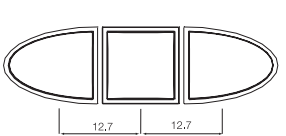

| Cap series    | Recommended<br>min. switch spacing AxB | Nominal cap dimension<br>WxH | Recommended<br>min. panel cut-out |
|---------------|--|------------------------------|-----------------------------------|
| 1A/1H         | 12.7x10.16                             | 12.6x10.1                    | 13.0x10.5                         |
| 1B/1C+2C/2D   | 15.24x15.24                            | 15.1x15.1                    | 15.5x15.5                         |
| 1DS/1ES/1FS   | 12.7x12.7                              | ø9.6                         | ø10.0                             |
| 1GAS          | 12.7x11.14                             | ø11                          | ø11.4                             |
| 1GCS          | 15.14x15.14                            | ø15                          | ø15.4                             |
| 1JS           | 12.7x12.7                              | ø9.6                         | ø10.4                             |
| 1KS/1KBS/1KCS | 15.24x15.24                            | 14.3x14.3                    | 14.7x14.7                         |
| 1M            | 25.4x10.16                             | 25.0x10.                     | 25.7x10.5                         |
| 1NS           | 12.7x12.7                              | ø9.8/□4.9                    | ø10.2/□5.1                        |
| 1PS/1QS/1RS   | 15.24x10.16                            | 6.5x12.5                     | 7.0x13.0, R max. 1.0              |
| 1SS/1IS/1LS   | 12.7x12.7                              | ø6.5                         | ø7.0                              |
| 1TS           | 12.7x12.7                              | 10.6x10.6                    | 11.0x11.0                         |
| 1US           | 12.7x12.7                              | ø10.6                        | ø11.0                             |
| 1VS           | 12.7x12.7                              | 10.6x13.25                   | 11.0x13.65                        |
| 1WAS/1WPS     | 12.7x10.3                              | 12.5x6.5                     | 12.9x6.9                          |
| 1WDS          | 15.34x10.3                             | 15.2x8.0                     | 15.6x8.4                          |
| 1XS           | 12.7x12.7                              | 9.4x7.4                      | 9.8x7.9                           |
| 1YS           | 17x17                                  | 15x15                        | 16x16                             |
| 1ZA           | 18.84x10.3                             | 18.7x10.1                    | 19.4x10.5                         |
| 1ZB           | 24.34x12.1                             | R1=7.4; R2=17.5 90°          | R1=7.1; R2=17.5-17.75 90°         |
| 1ZCS          | 14.44x14.44                            | ø14.3                        | ø14.7                             |
| 1Z/1ZW        | 35.5x35.5; 41.6x41.6                   | ø29.5                        | ø30.3                             |
| 10R/10RF/10RM | 40.5x40.5                              | ø30.0                        | ø30.6                             |
| 10Q/10QM      | 32.5x32.5                              | 22x22                        | 22.5x22.5                         |

## Tape & Reel

Tape and reel is available for the parts listed and has the following specifications:

|                |          |                         |                      |
|----------------|----------|-------------------------|----------------------|
| Reel diameter: | Ø330mm   | Tape and reel material: | antistatic or better |
| Tape width:    | 24mm     | Quantity per reel:      | see list             |
| Pitch:         | see list |                         |                      |

### 3C/3E/5E/5G multimec® tape & reel

| Part No.                                  | Ordering Code      | Pitch | Quantity per reel |
|---|--------------------|-------|-------------------|
| 3CSH9                                     | 3CSH9R             | 16    | 500               |
| 3ESH9                                     | 3ESH9R             | 16    | 500               |
| 5ESH9XX                                   | 5ESH9XXR           | 16    | 500               |
| 5GSH9XX                                   | 5GSH9XXR           | 16    | 500               |
| 5XSH9XX1SSXX-08.0                         | 5XSH9XXR1SSXX-08.0 | 20    | 250               |
| 5XSH9XX1SSXX-09.5                         | 5XSH9XXR1SSXX-09.5 | 20    | 250               |
| 5XSH9XX1SSXX-10.4                         | 5XSH9XXR1SSXX-10.4 | 20    | 250               |
| 5XSH9XX1SSXX-11.0                         | 5XSH9XXR1SSXX-11.0 | 20    | 250               |
| 5XSH9XX1SSXX-12.0                         | 5XSH9XXR1SSXX-12.0 | 20    | 250               |
| All varimec h <12.5; add R after part no. |                    |       | 20 250            |

### illuminated 5G multimec® tape & reel

| Part No.    | Ordering Code | Pitch | Quantity per reel |
|-------------|---------------|-------|-------------------|
| 5GSH9XX02   | 5GSH9XX02R    | 20    | 250               |
| 5GSH9XX22   | 5GSH9XX22R    | 20    | 250               |
| 5GSH9XX42   | 5GSH9XX42R    | 20    | 250               |
| 5GSH9XX61   | 5GSH9XX61R    | 20    | 250               |
| 5GSH9XX82   | 5GSH9XX82R    | 20    | 250               |
| 5GSH9XX2242 | 5GSH9XX2242R  | 20    | 250               |
| 5GSH9XX8222 | 5GSH9XX8222R  | 20    | 250               |
| 5GSH9XX8242 | 5GSH9XX8242R  | 20    | 250               |

## How to assemble

multimec®  
5GS+1A/H

multimec®  
5GS+1B/C+2C/D

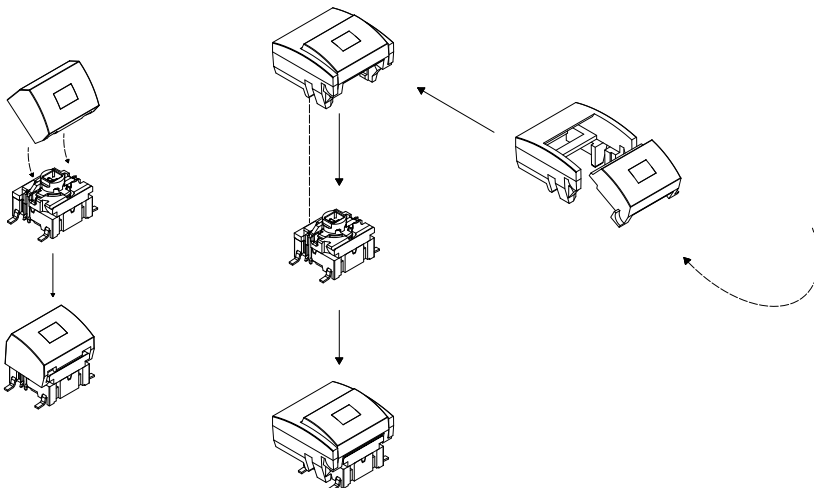

## Operating force

(typical example)

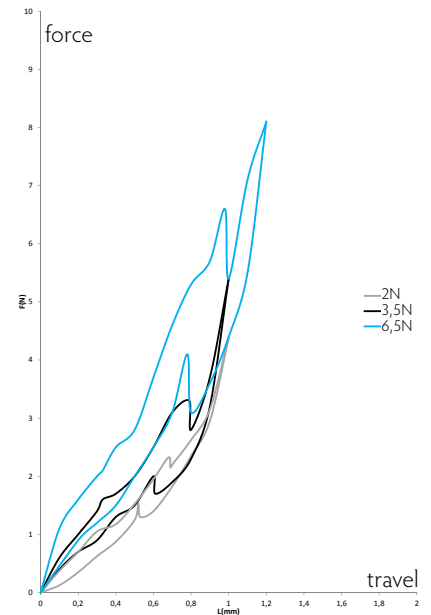

## Mounting tool for multimec® through-hole switches

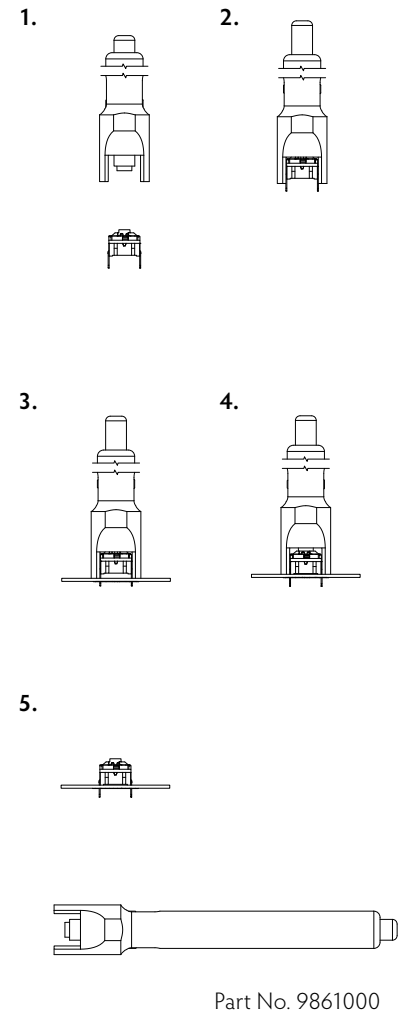

## RoHS Compatible

|   | HIGH TEMPERATURE VERSIONS  |                               |                   |
|---|--|-------------------------------|-------------------|
|   | SILVER   | GOLD                          | NC/NO             |
| <b>ELECTRICAL SPECIFICATIONS</b>          |  |                               |                   |
| Contact resistance                        | <30m Ω - typ. 10m Ω  |                               |                   |
| Insulation resistance                     | >10M Ω   |                               |                   |
| Recommended load                          | 0.5-50mA 24VDC   | 0.5μ-50mA 24VDC               |                   |
| Contact bounce                            | <2mS - typically 0.5mS   |                               |                   |
| <b>MECHANICAL SPECIFICATIONS</b>          |  |                               |                   |
| Standard actuation force (switch)         | 2.0N, 3.5N, 6.5 N  |                               | 3.5N              |
| Max. Actuation force without cap          | 115N for 60 sec  | (according to MIL-PRF-22885H) | 100N for 10 sec   |
| Key travel (switch)                       | 1 mm   |                               |                   |
| Life time (switch)                        | >10,000,000 cycles   |                               | >1,000,000 cycles |
| <b>TEMPERATURE RANGE</b>                  |  |                               |                   |
| Working temperature                       | Min -40°C Max +160°C   |                               |                   |
| Storage temperature                       | Min -40°C Max +160°C   |                               |                   |
| 5G with LED (working & storage temp)      | Min -30°C Max +85°C  |                               |                   |
| Soldering (through-hole switch)           | IEC 68-2-20 8:   |                               |                   |
|   | Infrared, vapour phase, wave - max 240°C for max 40 sec or max 260°C for max 30 sec. |                               |                   |
|   | Soldering iron - max 350°C for max 3 sec.  |                               |                   |
|   | Flux tight.  |                               |                   |
| <b>SOLDERING (SMD)</b>                    | JEDEC J-STD-020C   |                               |                   |
| <b>ENVIRONMENTAL ENDURANCE IEC 68-2-3</b> |  |                               |                   |
| Temperature                               | +40°C  |                               |                   |
| Humidity                                  | 93% RH   |                               |                   |
| Duration                                  | 56 Days  |                               |                   |
| <b>TEMPERATURE CYCLING IEC 68-2-14</b>    |  |                               |                   |
| Temperature limit                         | Min -55°C - Max +85°C  |                               |                   |
| Number of cycles                          | 200  |                               |                   |
| Exposure time at each temperature         | 10 min   |                               |                   |
| Recovery time before measurements         | 16 hrs   |                               |                   |
| Sealing IEC 529                           | IP-67  |                               |                   |
| Cleaning                                  | Standard methods - see usage guidelines  |                               |                   |
| <b>MATERIAL SPECIFICATIONS - SWITCHES</b> |  |                               |                   |
| Housing                                   | PPS UL94V0   |                               |                   |
| Actuator                                  | PPS UL94V0   |                               |                   |
| Sealing + spring                          | Silicone rubber  |                               |                   |
| Contact spring                            | Stainless steel  |                               | Stainless steel   |
|   | + 3μAg   |                               | + 1μAu            |
| Fixed contacts                            | SnCu + 2μNI + 3μAg   | SnCu + 2μNI + 1μAu            |                   |
| Terminals                                 | SnCu + 2μNI + 3μSn100  |                               |                   |

## Caps, Bezels & Legends – Material Specifications

| MATERIAL         | PARTS   | TEMP. LIMIT | UL RATING |
|------------------|---|-------------|-----------|
| ABS              | 1A, 1B, 1C, 1DS, 1ES, 1FS, 1H, 1JS, 1KS, 1LS, 1M, 1NS, 1PS, 1QS, 1RS, 1TS, 1US, 1VS, 1WAS, 1WDS, 1WPS, 1XS, 1Z, 1ZA, 1ZB, 1ZCS, 1ZW, 2C, 2D, 2K, reflectors for 1KBS/1KCS and 1YS | Max. 65°C   | UL94HB    |
| Polycarbonate    | All lenses and transparent colour caps, lids for 1KBS/1KCS  | Max. 85°C   | UL94HB    |
| Polyamide        | 1GAS/1GCS, 1SS, 2SS   | Max. 160°C  | UL94V2    |
| Legends Adhesion | DS/EN ISO 2409 Class 1 & ASTM D3359 Class 4B  |             |           |

### LEDs specifications

#### 5G switches

| Colour  |          | Blue                | Green   | Yellow  | White   | Red     | High Intensity Green |
|---|----------|---------------------|---------|---------|---------|---------|----------------------|
| Colour Codes  |          | 02                  | 22      | 42      | 61      | 82      | 29                   |
| <b>ABSOLUTE MAXIMUM RATINGS (Ta=25°C)</b>           |          |                     |         |         |         |         |                      |
| Power   | mW       | 95                  | 75      | 60      | 48      | 65      | 102.5                |
| Current forward                                     | mA       | 25                  | 30      | 25      | 15      | 25      | 25                   |
| Forward peak current                                | mA       | 100                 | 80      | 60      | 100     | 100     | 150                  |
| Voltage reverse                                     | V        | 5                   | 5       | 5       | NA      | 12      | 5                    |
| Operating temperature                               | °C       | -40/+85             | -55/+85 | -40/+85 | -40/+85 | -30/+85 | -40/+85              |
| Storage temperature                                 | °C       | -40/+90             | -55/+85 | -40/+90 | -40/+85 | -40/+85 | -40/+85              |
| Soldering temperature                               | °C       | 245 for max. 10 sec |         |         |         |         |                      |
| <b>ELECTRICAL-OPTICAL CHARACTERISTICS (Ta=25°C)</b> |          |                     |         |         |         |         |                      |
| Voltage forward                                     | Typ. V   | 3.3                 | 2       | 1.75**  | 2.85    | 2       | 3.3                  |
|   | Max. V   | 3.7                 | 2.4     | 2.35    | 3.1     | 2.5     | 4.1                  |
| Current reverse (VR=5V)                             | Max. µA  | 50                  | 100     | 10      | NA      | 100     | 50                   |
| Wave length   | nm       | 470                 | 571     | 591     | NA      | 633     | 525                  |
| Spread  | Δnm      | 25                  | NA      | 15      | NA      | 16      | 30                   |
| Spread angle  | degree   | 120                 | 130     | 120     | 150     | 160     | 60                   |
| <b>Luminous Intensity</b>                           | Min. mcd | 45                  | 18      | 28.5    | 71      | 28      | 500                  |
|   | Typ. mcd | 112*                | 35      | 72*     | 224*    | 180*    | 1000                 |
| Optical intensity                                   | Lm/w     | NA                  | NA      | NA      | 36      | 7       | NA                   |

\*Max.mcd \*\*Min. V

#### 3F switches

#### 3FXXX (for 1E-1F-1N-1Q-1R-1S-1X)

#### 3FXXX (for 1K-1T-1U-1V-1W-1WD)

| Colour  |  | B                 | G    | Y    | W        | R        | G/Y               | R/G      | R/Y     | G                 | Y                 | R        |
|---|--|-------------------|------|------|----------|----------|-------------------|----------|---------|-------------------|-------------------|----------|
| Colour Codes  |  | 00                | 20   | 40   | 65       | 80       | 2040              | 8020     | 8040    | 24                | 46                | 87       |
| <b>Absolute Maximum Ratings</b>                     | (Ta=25°C)  |                   |      |      |          |          |                   |          |         |                   |                   |          |
| Power   | mW   | 105               | 70   | 60   | 120      | 60       | 120               | 100      | 120     | 60                | 60                | 120      |
| Current forward                                     | mA   | 30                | 20   | 20   | 25       | 20       | 25                | 30       | 25      | 25                | 25                | 50       |
| Forward peak current                                | mA   | 150               | 60** | 60** | 100      | 60**     | 150               | 120      | 150     | 60                | 60                | 200      |
| Voltage reverse                                     | V  | 5                 | 3    | 3    | 5        | 3        | 5                 | 5        | 5       | 5                 | 5                 | 5        |
| Operating temperature                               | °C   | -40/+85           |      |      | -40/+85  | -25/+85  | -40/+85           | -55/+100 | -40/+85 | -40/+85           | -40/+85           | -40/+85  |
| Storage temperature                                 | °C   | -40/+85           |      |      | -40/+100 | -30/+100 | -40/+85           | -55/+100 | -40/+85 | -40/+85           | -40/+100          | -40/+100 |
| Soldering temperature                               | °C   | 260 for max 5 sec |      |      |          |          | 260 for max 2 sec |          |         | 300 for max 3 sec | 260 for max 5 sec |          |
| <b>Electrical-Optical Characteristics (Ta=25°C)</b> |  |                   |      |      |          |          |                   |          |         |                   |                   |          |
| Voltage forward                                     | Typ. V   | 3.8               | 2.1  | 2.1  | 3.8      | 2.0      | 2.1               | 2.0      | 2.1     | 2.0*              | 2.0               | 2.0***   |
|   | Max. V   | 4.5               | 3.0  | 3.0  | 4.3      | 3.0      | 2.8               | 2.6      | 2.8     | 2.4*              | 2.4               | 2.4***   |
| Current reverse (VR=5V)                             | µA   | 10                | 10   | 10   | 50       | 10       | 2                 | 2        | 2       | 10                | 10                | 10       |
| Wave length   | nm   | 466               | 563  | 585  | NA       | 650      | 565/590           | 630/565  | 625/590 | 570               | 589               | 624/632  |
| Spread  | Δnm  | 60                | 40   | 40   | NA       | 40       | 35                | 35       | 35      | 10                | NA                | 20       |
| Spread angle  | degree   | 60                | 45   | 45   | 25       | 45       | 60                | 200      | 60      | 100               | 40                | 40       |
| <b>Luminous Intensity</b>                           | Min. mcd   | 18                | 9.0  | 5.6  | 630      | 5.6      | 8                 | 2.2      | 8       | 70****            | 630               | 400****  |
|   | Typ. mcd   | 50                | 25   | 16   | 1000     | 16       | 25                | 4.8      | 25      | 20****            | 1250              | 800****  |
| Orientation   | The longer pin is the anode, the shorter is the cathode.<br>For bicolour LEDs the anode for the first colour (ex. 2080) is the longer pin. |                   |      |      |          |          |                   |          |         |                   |                   |          |

\*\*Pulse width 1ms Duty cycle 1:5, \*\*\*/F =50mA, \*\*\*\* Luminous Flux mlm

B=Blue, G=Green, Y=Yellow, R=Red, W=White

Specifications are subject to change without notice.

Specifications are subject to change without notice.

For product updates and/or changes of specifications please see [www.mec.dk](http://www.mec.dk)



# Usage guidelines

## How to get the best results with MEC Switches?

These guidelines are offered to users of MEC Switches as an aid to ensure successful and reliable switch operation.

### Temperature

Both unimec™ and multimec® switches are produced in low and high temperature versions. Please see the technical specifications for details on operating and storage temperatures and soldering guidelines to make sure you select the best switch for your application. When wave soldering is taking place, MEC strongly recommend that the temperature profile is analysed and compared with the temperature rating of the switch. In case of doubt always select the high temperature versions unimec™ 154XX, and multimec® 5XXH9XX. It is also important to monitor the accumulated heat build up from both the pre-heat zones and the solder zone.

Most standard accessories for both unimec™ and multimec® switches are made from ABS plastic with a maximum operating temperature of 65°C. It is strongly recommended that accessories are mounted after soldering of the switch. If this is not possible care must be taken not to overheat the accessories during the soldering process. The 1SS, 1GAS/1GCS and Varimec™ caps are, however, made of high temperature materials and will meet the same temperature specifications as the high temperature switches.

For accessories made from other plastic materials please see multimec® and unimec™ technical specifications.

LEDs have their own temperature specifications. When fitted in a high temperature switch the LED will determine the max. operating temperature, i.e. 5GTH93524 has an upper temperature limit of 85°C! This also applies with 3F switches.

### Mounting and Dismounting

If switches are to be mounted in rows it is essential that the recommendations regarding spacing are followed. PC board thickness should be 1.4±0.2 mm and terminal hole diameter should be 0.9mm.

All unimec™ and multimec® caps and bezels are easily snapped onto the switch modules and can be changed at a later time with the exception of the unimec 16.700 cap. The same applies to the 3E caps. Once these caps are installed they are not designed to be removed. To do so may cause damage to the switch and the PC board if not done very carefully. If the 16.300 or 16.700 cap must be removed from a unimec™ alternate action switch, make sure that the switch actuator is in the released, upper position before attempting to remove the cap. This will prevent possible damage to the internal latching pin.

Care must be taken when inserting the 3FT switch and LED assembly into the PC board. Do not press direct on the LED. This will force the LED down into the actuator and risks to cause the switch contacts to remain in the closed position. To correct the fault, the LED must be raised slightly and centered in the actuator to assure unrestricted movement of the actuator. A mounting tool is available for multimec® switches.

### Soldering and Cleaning unimec™

Most assembly and field problems experienced by users of unsealed switches are caused by the contamination of the contacts during soldering and cleaning.

Contact contamination may be recognised by an increase in contact resistance and possible intermittent operation of the switch, especially in low power applications. Care must be taken not to submerge the switch in cleaning agents or spray the switch during cleaning. The switch must be protected at all times to prevent contamination by flux or cleaning liquids.

For unimec™ alternate versions we recommend to leave the actuator in the released upper position during soldering. This makes the switch more resistant to overheating.

### Soldering and Cleaning multimec®

multimec® switches are fully sealed to IP67 specifications to prevent solder flux and aqueous based cleaning solutions from entering the switch and contaminating the contacts. The switches can be placed on the PC board with other components and wave soldered. multimec® offers a high level of sealing, however, with aqueous solvent solutions care must be taken to avoid the worst case situation with water jets, complete immersion into a liquid with a temperature below the board or surface tension reducing additives.

Recommended cleaning methods are demineralized water. Any surface tension reducing agents, such as soap, must not be used as they risk causing a potential leakage of the switch.

### Soldering - Through Hole Versions

Hand soldering: Max. 350°C for max. 3 sec., this applies for both low temperature and high temperature versions.

Wave soldering: heat built up in the switch during pre-heating and soldering must not exceed the maximum operating temperature of the switch. If, for some reason, a high pre-heating temperature is required, MEC recommend the high temperature switches. In any case peak temperature must not exceed 260°C, and soldering time is max 10 sec.

### Soldering - Surface Mount Versions

For all methods - infrared, convection and vapour phase. The upper limit 260°C/30 sec must be observed. The soldering temperature profile must have moderate temperature gradients.

### RoHS Compliance

As of 1 July 2006 MEC has completed the conversion to RoHS compliance. For more info please see our homepage [www.mec.dk](http://www.mec.dk)

### Temperature Limits:

|                         |             |
|-------------------------|-------------|
| Low temperature switch  | 115°C       |
| High temperature switch | 160°C       |
| LEDs                    | 85/100°C    |
| Accessories             | 65/85/160°C |

### Packaging

unimec™ and multimec® switches are packed in rigid tubes of 50 pieces each.

A box contains 1.000 pcs.

The surface mount versions of multimec® switches with a height up to 12.5mm can also be delivered on tape/reel. Each reel contains 250/500 pcs.

# Mouser Electronics

Authorized Distributor

Click to View Pricing, Inventory, Delivery & Lifecycle Information:

## Apem:

[1H096](#) [1A16](#) [1A40](#) [1A10](#) [1A00](#) [1A33](#) [1A30](#) [1A09](#) [1A03](#) [1A06](#) [1A53](#) [1A18](#) [1H092](#) [1A02](#) [1A50](#) [1A09XD033](#)  
[1A09XU048](#) [1A09XU135](#) [1A09XD018](#) [1A09XU000](#) [1A09XU031](#) [1A09XD011](#) [1A09XU010](#) [1A09XD008](#) [1A57](#)  
[1A09XD001](#) [1A09XU035](#) [1A04](#) [1A09XD014](#) [1A09XD107](#) [1A09XU013](#) [1A09XD004](#) [1A09XD123](#) [1A34](#) [1A09XU117](#)  
[1A09XU134](#) [1A09XD010](#) [1A09XU009](#) [1A09XD007](#) [1A09XD040](#) [1A09XD135](#) [1H036](#) [1A09XD059](#) [1A09XU002](#)  
[1A09XD013](#) [1A09XU015](#) [1A09XU116](#) [1A09XD035](#) [1H098](#) [1A09XD038](#) [1H088](#) [1A08](#) [1A09XD045](#) [1A09XD134](#)  
[1H094](#) [1A09XD056](#) [1A09XD034](#) [1H006](#) [1A09XD044](#) [1A09XD005](#) [1A09XU001](#) [1A09XD037](#) [1A09XD012](#)  
[1A09XU007](#) [1A09XD116](#) [1A09XD003](#) [1A09XU054](#) [1A09XD006](#) [1A09XD019](#) [1A09XU036](#) [1A09XU014](#) [1A09XU123](#)  
[1A09XU004](#) [1A09XU017](#) [1A09XU059](#) [1A09XU006](#) [1A09XU034](#) [1A09XU012](#) [1H091](#) [1A09XD031](#) [1A09XU005](#)  
[1A09XD016](#) [1H032](#) [1A09XD009](#) [1H038](#) [1A09XU044](#) [1A09XU133](#) [1A09XU107](#) [1A09XU011](#) [1A09XU040](#)  
[1A09XD054](#) [1A09XU038](#) [1A09XU003](#) [1A09XD036](#) [1A09XD017](#) [1H086](#) [1A09XU019](#) [1A09XU016](#) [1A09XU045](#)  
[1A09XU056](#)