

**SPECIFICATIONS:**

**ELECTRICAL:**

INSULATOR RESISTANCE: 5 G OHMS Min.  
 DIELECTRIC WITHSTANDING: 1,000VAC r.m.s.  
 OPERATING TEMPERATURE: -55° C ~ +125° C  
 POWER CONTACT RESISTANCE: 1.0 mOHMS Max.  
 SIGNAL CONTACT RESISTANCE: 2.7 mOHMS Max.  
 POWER PINS: SEE PART NUMBER BELOW  
 SIGNAL PINS: 5 AMPS

**MECHANICAL:**

CONTACT INSERTION FORCE: 4.5 Kg Max.  
 CONTACT SEPARATOR FORCE: 0.3Kg Min.

**MATERIALS:**

CONTACTS: COPPER ALLOY  
 INSULATOR: PBT UL94V-0 RATED, BLK  
 230°C PROCESS TEMP.  
 SHELL: STEEL

**FINISH:**

SHELL: NICKEL  
 CONTACTS: FULL GOLD FLASH

**680M7W2203LYY1**

2 = 20 AMP  
 4 = 40 AMP  
 0 = NO HARDWARE  
 1 = 0.098" CN TERMINATION SIDE  
 1 = GOLD FLASH  
 \*CONTACT NORCOMP FOR MORE OPTIONS

RoHS COMPLIANT

UNITS = inch [mm]

DO NOT SCALE FROM DRAWING



THESE DRAWINGS AND SPECIFICATIONS ARE THE PROPERTY OF NorComp AND SHALL NOT BE REPRODUCED, COPIED OR USED AS THE BASIS FOR THE MANUFACTURE OR SALE OF APPARATUS WITHOUT WRITTEN PERMISSION.

DRAWN: M. SIGMON  
 DATE: 08/20/2012

NorComp

SCALE: NTS	SHEET 1	OF 2	REV 1
DWG NO.		680M7W2203LYY1	

### HARDWARE OPTIONS

0 ..... NO HARDWARE

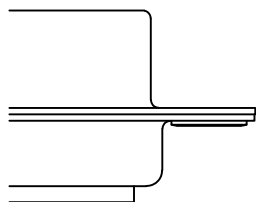

1 ..... 0.098" TERMINATION SIDE

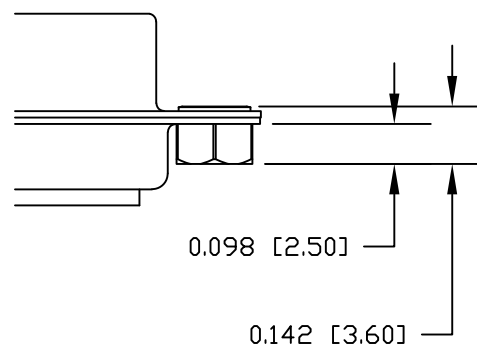

**NOTE:  
SIGNAL AND POWER CONTACTS  
COME PRE-LOADED INTO INSULATORS**

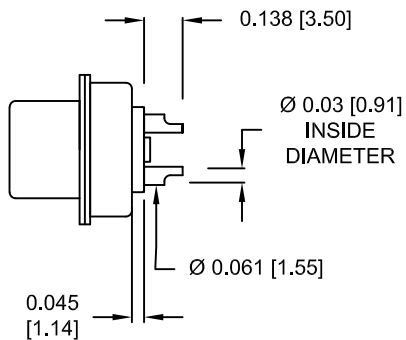

**SIGNAL CONTACTS**  
ACCEPTS UP TO 20 AWG WIRE

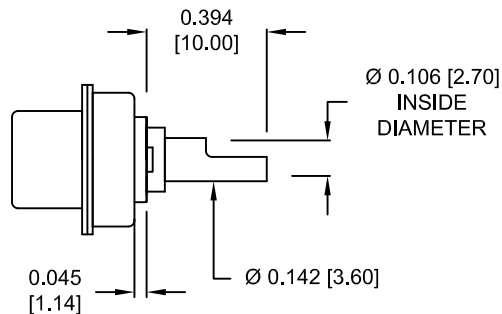

**20 AMP POWER CONTACTS**  
ACCEPTS UP TO 12 AWG WIRE

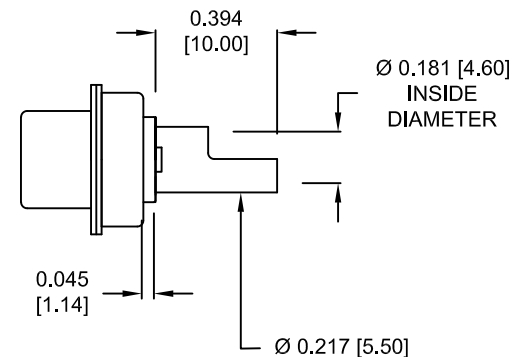

**40 AMP POWER CONTACTS**  
ACCEPTS UP TO 8 AWG WIRE

**RoHS COMPLIANT**

UNITS = inch [mm]

**DO NOT SCALE FROM DRAWING**



THESE DRAWINGS AND SPECIFICATIONS ARE THE PROPERTY OF NorComp AND SHALL NOT BE REPRODUCED, COPIED OR USED AS THE BASIS FOR THE MANUFACTURE OR SALE OF APPARATUS WITHOUT WRITTEN PERMISSION.

DRAWN:  
**M. SIGMON**  
DATE:  
08/20/2012

**NorComp**

SCALE:  
NTS  
DWG NO.

SHEET OF  
2 OF 2

REV  
1

**680M7W2203LYY1**

# Mouser Electronics

Authorized Distributor

Click to View Pricing, Inventory, Delivery & Lifecycle Information:

[NorComp:](#)

[680M7W2203L201](#) [680M7W2203L401](#)