

Overview

KEMET's ALC40 Series of snap-in capacitors features the same high ripple currents and long-life characteristics as the ALC10 Series but can operate at higher temperatures.

Applications

KEMET's ALC40 capacitors are suited for high reliability and long life applications such as frequency converters, uninterruptible power supply (UPS) systems and switch mode power supplies (SMPS). The extended temperature range allows increased ripple currents at lower temperatures.

Benefits

- Compact size
- Long life, up to 9,000 hours at +105°C (V_R , I_R applied)
- High ripple current
- Excellent surge voltage capability
- Optimized designs available upon request

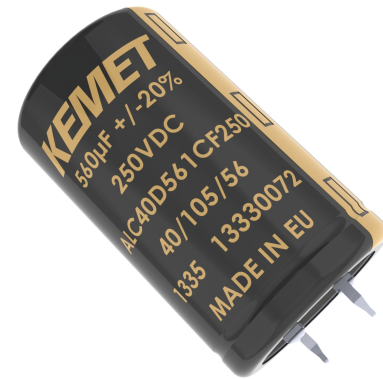

Part Number System

| ALC40 | A | 822 | BB | 025 | |
|-------------------------------|-----------------------|--|---------------------|--|---|
| Series | Termination | Capacitance Code (µF) | Size Code | Rated Voltage (VDC) | |
| Snap-In Aluminum Electrolytic | See Termination Table | First two digits represent significant figures. Third digit specifies number of zeros. | See Dimension Table | 025 = 25 040 = 40 063 = 63 100 = 100 200 = 200 | 250 = 250 350 = 350 400 = 400 450 = 450 500 = 500 |

Performance Characteristics

| Item | Performance Characteristics | | |
|-------------------------------|--|--|---|
| Capacitance Range | 47 – 120,000 μ F | | |
| Rated Voltage | 25 – 500 VDC | | |
| Operating Temperature | –40 to +105°C | | |
| Storage Temperature Range | –55 to +105°C | | |
| Capacitance Tolerance | \pm 20% at 100 Hz/+20°C | | |
| Operational Lifetime | D (mm) | Rated Voltage and Ripple Current at +105°C (hours) | Rated Voltage at +105°C (hours) |
| | 25 | 6,000 | 10,000 |
| | 30 | 7,000 | 11,000 |
| | 35 | 8,000 | 13,000 |
| | 40 – 50 | 9,000 | 14,000 |
| End of Life Requirement | Δ C/C < \pm 10%, ESR < 2 x initial ESR value, IL < initial specified limit | | |
| Shelf Life | 2,000 hours at +85°C or 30,000 hours at +40°C 0 VDC | | |
| Leakage Current | I = 0.003 CV or 6,000 (μ A, whichever is smaller) | | |
| | C = rated capacitance (μ F), V = rated voltage (VDC). Voltage applied for 5 minutes at +20°C. | | |
| Vibration Test Specifications | | Procedure | Requirements |
| | D \leq 40 mm | 0.75 mm displacement amplitude or 10 G maximum acceleration. Vibration applied for three 2-hour sessions at 10 – 500 Hz (Capacitor clamped by body). | No leakage of electrolyte or other visible damage. Deviations in capacitance from initial measurements must not exceed: Δ C/C < 5% |
| D > 40 mm | 0.35 mm displacement amplitude or 5 G maximum acceleration. Vibration applied for three 0.5-hour sessions at 10 – 55 Hz (Capacitor clamped by body). | | |
| Standards | IEC 60384–4 long life grade 40/105/56 | | |

Surge Voltage

| Condition | Voltage (VDC) | | | | | | | | | |
|--|---------------|----|------|-----|-----|-----|-----|-----|-----|-----|
| | 25 | 40 | 63 | 100 | 200 | 250 | 350 | 400 | 450 | 500 |
| \leq 30s Surge followed by a no load period of 330s, 1,000 cycles at +85°C | 28.75 | 46 | 72.5 | 115 | 230 | 288 | 385 | 440 | 495 | 550 |

Test Method & Performance

| Endurance Life Test | | |
|------------------------------|--|---------------------------------|
| Conditions | Performance | |
| Temperature | +105°C | |
| Test Duration | 5,000 hours | |
| Ripple Current | Rated ripple current in specified table | |
| Voltage | The sum of DC voltage and the peak AC voltage must not exceed the rated voltage of the capacitor | |
| Performance | The following specifications will be satisfied when the capacitor is tested at +20°C: | |
| Capacitance Change | ≤ 160 V | Within 15% of the initial value |
| | > 160 V | Within 10% of the initial value |
| Equivalent Series Resistance | Does not exceed 200% of the initial value | |
| Leakage Current | Does not exceed leakage current limit | |

Dimensions – Millimeters

| Size Code | Dimensions in mm | | Approximate Weight Grams |
|-----------|------------------|----|--------------------------|
| | D | L | |
| | -0/+1 | ±2 | |
| BB | 25 | 30 | 28 |
| BC | 25 | 35 | 30 |
| BD | 25 | 40 | 35 |
| CB | 30 | 30 | 35 |
| CC | 30 | 35 | 40 |
| CD | 30 | 40 | 45 |
| CE | 30 | 45 | 50 |
| CF | 30 | 50 | 55 |
| DB | 35 | 30 | 42 |
| DC | 35 | 35 | 50 |
| DD | 35 | 40 | 55 |
| DE | 35 | 45 | 65 |
| DF | 35 | 50 | 70 |
| DG | 35 | 55 | 75 |
| DH | 35 | 60 | 80 |
| DL | 35 | 80 | 105 |
| EB | 40 | 30 | 49 |
| EC | 40 | 35 | 57 |
| ED | 40 | 40 | 65 |
| EE | 40 | 45 | 80 |
| EF | 40 | 50 | 82 |
| EG | 40 | 55 | 95 |

Note: Dimensions include sleeving

| Size Code | Dimensions in mm | | Approximate Weight Grams |
|-----------|------------------|-----|--------------------------|
| | D | L | |
| | -0/+1 | ±2 | |
| EH | 40 | 60 | 98 |
| EL | 40 | 80 | 131 |
| EP | 40 | 105 | 170 |
| FB | 45 | 30 | 62 |
| FC | 45 | 35 | 72 |
| FD | 45 | 40 | 82 |
| FE | 45 | 45 | 92 |
| FF | 45 | 50 | 103 |
| FG | 45 | 55 | 113 |
| FH | 45 | 60 | 123 |
| FL | 45 | 80 | 164 |
| FP | 45 | 105 | 215 |
| KB | 50 | 30 | 75 |
| KC | 50 | 35 | 88 |
| KD | 50 | 40 | 100 |
| KE | 50 | 45 | 113 |
| KF | 50 | 50 | 126 |
| KG | 50 | 55 | 138 |
| KH | 50 | 60 | 151 |
| KL | 50 | 80 | 201 |
| KP | 50 | 105 | 264 |

Note: Dimensions include sleeving

Termination Tables

| Termination Code | A | D | F | C | E | G | H |
|------------------|---|---|---|---|---|---|---|
| Diameter (mm) | | | | | | | |
| 25 | • | • | • | | | | |
| 30 | • | • | • | | | | |
| 35 | • | • | • | • | • | | |
| 40 | • | • | • | • | • | • | • |
| 45 | | | | • | • | • | • |
| 50 | | | | • | • | • | • |

Mounting: These capacitors are designed to be mounted by their terminations alone and may be used in any position. Dummy pins must be isolated on 4 and 5 pin styles.

| Termination Code | Termination Style | LL |
|-----------------------------|-------------------|-----|
| | | ±1 |
| Standard Termination Option | | |
| A | 2 Pin | 6.3 |
| G (D ≥ 45) | 5 Pin | 6.3 |
| Other Termination Options | | |
| D | 2 Pin | 4.0 |
| F | 3 Pin | 4.0 |
| C | 4 Pin | 6.3 |
| E | 4 Pin | 4.0 |
| H | 5 Pin | 4.0 |

Dimensions in mm

Termination Tables cont.

Style A/D

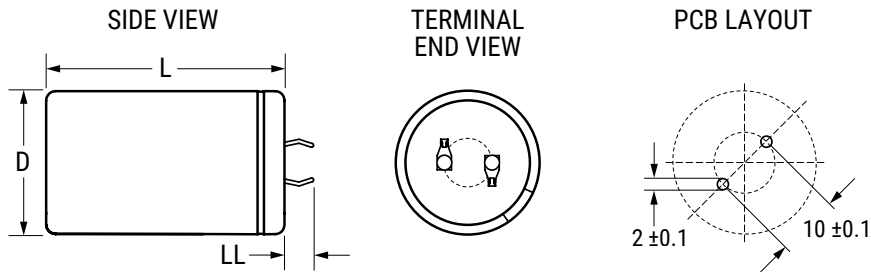

Style F

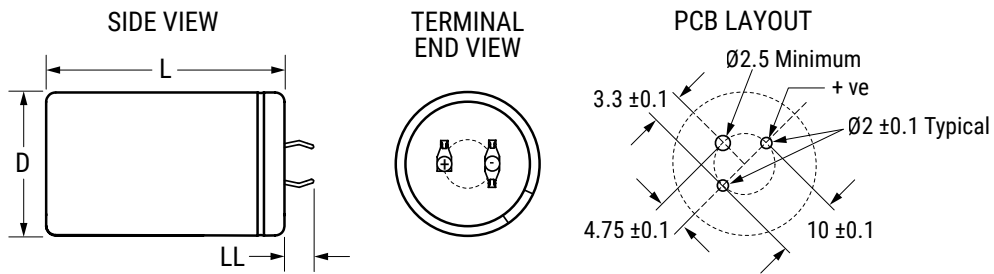

Style C/E

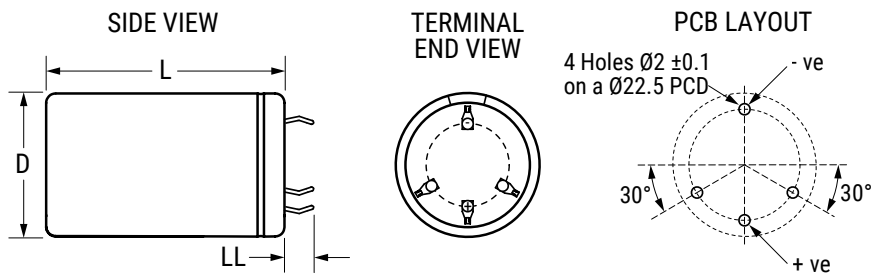

Style G/H

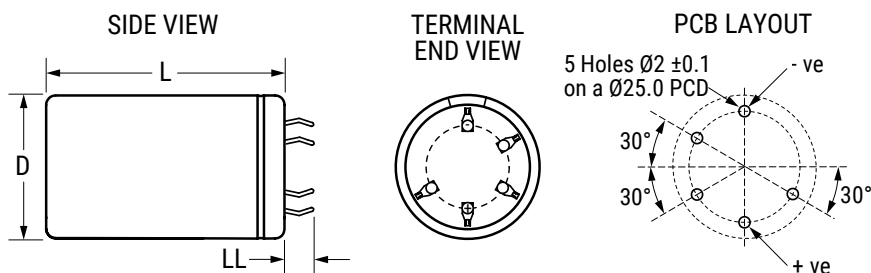

Shelf Life

The capacitance, ESR and impedance of a capacitor will not change significantly after extended storage periods, however the leakage current will very slowly increase. KEMET products are particularly stable and allow a shelf life in excess of three years at 40°C. See sectional specification under each product series for specific data.

Re-age (Reforming) Procedure

Apply the rated voltage to the capacitor at room temperature for a period of one hour, or until the leakage current has fallen to a steady value below the specified limit. During re-aging a maximum charging current of twice the specified leakage current or 5 mA (whichever is greater) is suggested.

Reliability

The reliability of a component can be defined as the probability that it will perform satisfactorily under a given set of conditions for a given length of time.

In practice, it is impossible to predict with absolute certainty how any individual component will perform; thus, we must utilize probability theory. It is also necessary to clearly define the level of stress involved (e.g. operating voltage, ripple current, temperature and time). Finally, the meaning of satisfactory performance must be defined by specifying a set of conditions which determine the end of life of the component.

Reliability as a function of time, $R(t)$, is normally expressed as: $R(t) = e^{-\lambda t}$

where $R(t)$ is the probability that the component will perform satisfactorily for time t , and λ is the failure rate.

Failure Rate

The failure rate is the number of components failing per unit time. The failure rate of most electronic components follows the characteristic pattern:

- Early failures are removed during the manufacturing process.
- The operational life is characterized by a constant failure rate.
- The wear out period is characterized by a rapidly increasing failure rate.

The failures in time (FIT) are given with a 60% confidence level for the various type codes. By convention, FIT is expressed as 1×10^{-9} failures per hour. Failure rate is also expressed as a percentage of failures per 1,000 hours.

e.g., 100 FIT = 1×10^{-7} failures per hour = 0.01%/1,000 hours

End of Life Definition

Catastrophic Failure: short circuit, open circuit or safety vent operation

Parametric Failure:

- Change in capacitance $> \pm 10\%$
- Leakage current $>$ specified limit
- ESR $> 2 \times$ initial ESR value

MTBF

The mean time between failures (MTBF) is simply the inverse of the failure rate.

$$MTBF = 1/\lambda$$



The failure rate is derived from our periodic test results. The failure rate (λ_R) is, therefore, only given at test temperature for life tests. An estimation is also given at 40°C. The expected failure rate for this capacitor range is based on our periodic test results for capacitors with structural similarity. Failure rate is frequently quoted in FIT (Failures In Time) where 1 FIT = 1×10^{-9} failures per hour. Failure rate per hour includes both catastrophic and parametric failures.

| T_a | Failure Rate per Hour |
|-------|-----------------------|
| 85°C | 250 FIT |
| 40°C | 12 FIT |

Environmental Compliance



All Part Numbers in this datasheet are Reach and RoHS compliant.

As an environmentally conscious company, KEMET is working continuously with improvements concerning the environmental effects of both our capacitors and their production.

In Europe (RoHS Directive) and in some other geographical areas such as China, legislation has been put in place to prevent the use of some hazardous materials, such as lead (Pb), in electronic equipment. All products in this catalog are produced to help our customers' obligations to guarantee their products and fulfill these legislative requirements. The only material of concern in our products has been lead (Pb), which has been removed from all designs to fulfill the requirement of containing less than 0.1% of lead in any homogeneous material. KEMET will closely follow any changes in legislation worldwide and make any necessary changes in its products, whenever needed.

Some customer segments such as medical, military and automotive electronics may still require the use of lead in electrode coatings. To clarify the situation and distinguish products from each other, a special symbol is used on the packaging labels for RoHS compatible capacitors.

Due to customer requirements, there may appear additional markings such as lead-free (LF), or lead-free wires (LFW) on the label.

Table 1 – Ratings & Part Number Reference

| VDC | Rated Capacitance | Size Code | Case Size | Ripple Current | | ESR Maximum | Impedance Maximum | Part Number |
|-----|---------------------|-----------|------------|---------------------|---------------------|---------------------|---------------------|------------------|
| | 100 Hz 20°C (µF) | | D x L (mm) | 100 Hz 105°C (A) | 10 kHz 105°C (A) | 100 Hz 20°C (mΩ) | 10 kHz 20°C (mΩ) | |
| 25 | 8200 | BB | 25 x 30 | 1.97 | 2.11 | 183 | 157 | ALC40(1)822BB025 |
| 25 | 10000 | BC | 25 x 35 | 2.33 | 2.50 | 148 | 126 | ALC40(1)103BC025 |
| 25 | 12000 | BD | 25 x 40 | 2.74 | 2.93 | 123 | 105 | ALC40(1)123BD025 |
| 25 | 12000 | CB | 30 x 30 | 2.18 | 2.33 | 157 | 138 | ALC40(1)123CB025 |
| 25 | 15000 | CC | 30 x 35 | 2.65 | 2.83 | 125 | 109 | ALC40(1)153CC025 |
| 25 | 18000 | CD | 30 x 40 | 3.04 | 3.24 | 103 | 91 | ALC40(1)183CD025 |
| 25 | 22000 | DC | 35 x 35 | 2.91 | 3.10 | 116 | 104 | ALC40(1)223DC025 |
| 25 | 27000 | CF | 30 x 50 | 3.94 | 4.21 | 73 | 64 | ALC40(1)273CF025 |
| 25 | 27000 | DD | 35 x 40 | 3.34 | 3.56 | 96 | 86 | ALC40(1)273DD025 |
| 25 | 27000 | EB | 40 x 30 | 4.03 | 4.09 | 75 | 69 | ALC40(1)273EB025 |
| 25 | 33000 | DF | 35 x 50 | 4.32 | 4.61 | 70 | 63 | ALC40(1)333DF025 |
| 25 | 33000 | EC | 40 x 35 | 4.83 | 4.90 | 66 | 62 | ALC40(1)333EC025 |
| 25 | 39000 | DF | 35 x 50 | 4.32 | 4.61 | 69 | 62 | ALC40(1)393DF025 |
| 25 | 39000 | ED | 40 x 40 | 5.57 | 5.65 | 53 | 49 | ALC40(1)393ED025 |
| 25 | 47000 | EF | 40 x 50 | 7.30 | 7.40 | 41 | 37 | ALC40(1)473EF025 |
| 25 | 56000 | EG | 40 x 55 | 7.51 | 7.61 | 38 | 35 | ALC40(1)563EG025 |
| 25 | 82000 | EL | 40 x 80 | 11.06 | 11.24 | 22 | 20 | ALC40(1)823EL025 |
| 25 | 120000 | EP | 40 x 105 | 13.41 | 14.05 | 18 | 17 | ALC40(1)124EP025 |
| 40 | 3900 | BB | 25 x 30 | 1.87 | 2.09 | 202 | 166 | ALC40(1)392BB040 |
| 40 | 5600 | BC | 25 x 35 | 2.23 | 2.49 | 149 | 124 | ALC40(1)562BC040 |
| 40 | 5600 | CB | 30 x 30 | 2.08 | 2.31 | 171 | 144 | ALC40(1)562CB040 |
| 40 | 6800 | BD | 25 x 40 | 2.61 | 2.92 | 123 | 102 | ALC40(1)682BD040 |
| 40 | 6800 | CC | 30 x 35 | 2.55 | 2.84 | 145 | 120 | ALC40(1)682CC040 |
| 40 | 8200 | CC | 30 x 35 | 2.53 | 2.81 | 129 | 110 | ALC40(1)822CC040 |
| 40 | 10000 | CD | 30 x 40 | 2.90 | 3.22 | 107 | 91 | ALC40(1)103CD040 |
| 40 | 12000 | CF | 30 x 50 | 3.75 | 4.18 | 80 | 68 | ALC40(1)123CF040 |
| 40 | 12000 | DC | 35 x 35 | 2.77 | 3.08 | 121 | 106 | ALC40(1)123DC040 |
| 40 | 12000 | EB | 40 x 30 | 4.13 | 4.22 | 88 | 79 | ALC40(1)123EB040 |
| 40 | 15000 | DD | 35 x 40 | 3.18 | 3.53 | 100 | 87 | ALC40(1)153DD040 |
| 40 | 15000 | ED | 40 x 40 | 5.66 | 5.78 | 63 | 56 | ALC40(1)153ED040 |
| 40 | 18000 | DF | 35 x 50 | 4.12 | 4.58 | 73 | 64 | ALC40(1)183DF040 |
| 40 | 18000 | EE | 40 x 45 | 6.46 | 6.60 | 53 | 47 | ALC40(1)183EE040 |
| 40 | 22000 | EF | 40 x 50 | 7.34 | 7.50 | 43 | 39 | ALC40(1)223EF040 |
| 40 | 27000 | EG | 40 x 55 | 7.50 | 7.63 | 39 | 35 | ALC40(1)273EG040 |
| 40 | 47000 | EL | 40 x 80 | 10.42 | 10.59 | 23 | 21 | ALC40(1)473EL040 |
| 40 | 68000 | EP | 40 x 105 | 12.71 | 13.47 | 17 | 16 | ALC40(1)683EP040 |
| 63 | 2200 | BB | 25 x 30 | 1.69 | 1.98 | 227 | 180 | ALC40(1)222BB063 |
| 63 | 3300 | BC | 25 x 35 | 2.01 | 2.35 | 165 | 133 | ALC40(1)332BC063 |
| 63 | 3900 | BD | 25 x 40 | 2.36 | 2.75 | 138 | 111 | ALC40(1)392BD063 |
| 63 | 3900 | CB | 30 x 30 | 1.88 | 2.18 | 185 | 154 | ALC40(1)392CB063 |
| 63 | 4700 | CC | 30 x 35 | 2.28 | 2.65 | 148 | 123 | ALC40(1)472CC063 |
| 63 | 5600 | CD | 30 x 40 | 2.61 | 3.03 | 122 | 102 | ALC40(1)562CD063 |
| 63 | 5600 | EB | 40 x 30 | 3.82 | 3.91 | 102 | 90 | ALC40(1)562EB063 |
| 63 | 6800 | CF | 30 x 50 | 3.39 | 3.93 | 92 | 75 | ALC40(1)682CF063 |
| 63 | 6800 | DC | 35 x 35 | 2.50 | 2.90 | 141 | 119 | ALC40(1)682DC063 |
| 63 | 6800 | EC | 40 x 35 | 4.18 | 4.26 | 91 | 81 | ALC40(1)682EC063 |
| 63 | 8200 | CF | 30 x 50 | 3.33 | 3.98 | 48 | 35 | ALC40(1)822CF063 |
| 63 | 8200 | DD | 35 x 40 | 2.87 | 3.33 | 116 | 99 | ALC40(1)822DD063 |
| 63 | 8200 | ED | 40 x 40 | 5.01 | 5.12 | 72 | 64 | ALC40(1)822ED063 |
| 63 | 10000 | DF | 35 x 50 | 3.71 | 4.31 | 85 | 72 | ALC40(1)103DF063 |
| 63 | 10000 | EE | 40 x 45 | 5.69 | 5.81 | 60 | 53 | ALC40(1)103EE063 |
| 63 | 12000 | EF | 40 x 50 | 6.50 | 6.64 | 50 | 44 | ALC40(1)123EF063 |
| 63 | 15000 | EH | 40 x 60 | 7.81 | 7.99 | 39 | 34 | ALC40(1)153EH063 |
| 63 | 22000 | EL | 40 x 80 | 9.70 | 9.92 | 27 | 24 | ALC40(1)223EL063 |
| 63 | 33000 | EP | 40 x 105 | 12.01 | 13.01 | 18 | 17 | ALC40(1)333EP063 |
| 100 | 820 | BB | 25 x 30 | 1.39 | 1.82 | 294 | 220 | ALC40(1)821BB100 |
| 100 | 1000 | BC | 25 x 35 | 1.65 | 2.16 | 238 | 177 | ALC40(1)102BC100 |
| 100 | 1200 | BD | 25 x 40 | 1.93 | 2.53 | 198 | 147 | ALC40(1)122BD100 |
| 100 | 1200 | CB | 30 x 30 | 1.57 | 2.01 | 245 | 191 | ALC40(1)122CB100 |

(1) Termination code: See Termination Tables for available options.

Table 1 – Ratings & Part Number Reference cont.

| VDC | Rated Capacitance | Size Code | Case Size | Ripple Current | | ESR Maximum | Impedance Maximum | Part Number |
|-----|---------------------|-----------|------------|---------------------|---------------------|---------------------|---------------------|------------------|
| | 100 Hz 20°C (µF) | | D x L (mm) | 100 Hz 105°C (A) | 10 kHz 105°C (A) | 100 Hz 20°C (mΩ) | 10 kHz 20°C (mΩ) | |
| 100 | 1500 | CC | 30 x 35 | 1.90 | 2.44 | 195 | 151 | ALC40(1)152CC100 |
| 100 | 1800 | CD | 30 x 40 | 2.18 | 2.80 | 162 | 125 | ALC40(1)182CD100 |
| 100 | 2200 | CF | 30 x 50 | 2.82 | 3.63 | 123 | 94 | ALC40(1)222CF100 |
| 100 | 2200 | DC | 35 x 35 | 2.10 | 2.67 | 177 | 142 | ALC40(1)222DC100 |
| 100 | 2200 | DE | 40 x 30 | 3.58 | 3.80 | 128 | 110 | ALC40(1)222EB100 |
| 100 | 2700 | DD | 35 x 40 | 2.41 | 3.07 | 146 | 118 | ALC40(1)272DD100 |
| 100 | 2700 | ED | 40 x 40 | 4.92 | 5.24 | 95 | 80 | ALC40(1)272ED100 |
| 100 | 3300 | DF | 35 x 50 | 3.12 | 3.97 | 108 | 86 | ALC40(1)332DF100 |
| 100 | 3300 | EE | 40 x 45 | 5.59 | 5.95 | 78 | 66 | ALC40(1)332EE100 |
| 100 | 3900 | EF | 40 x 50 | 6.41 | 6.83 | 65 | 55 | ALC40(1)392EF100 |
| 100 | 4700 | EG | 40 x 55 | 6.67 | 7.04 | 58 | 50 | ALC40(1)472EG100 |
| 100 | 5600 | EH | 40 x 60 | 7.46 | 7.87 | 49 | 42 | ALC40(1)562EH100 |
| 100 | 8200 | EL | 40 x 80 | 9.28 | 9.78 | 34 | 29 | ALC40(1)822EL100 |
| 100 | 10000 | EP | 40 x 105 | 11.33 | 13.12 | 24 | 21 | ALC40(1)103EP100 |
| 200 | 270 | BB | 25 x 30 | 1.01 | 1.56 | 542 | 377 | ALC40(1)271BB200 |
| 200 | 390 | BC | 25 x 35 | 1.24 | 1.86 | 386 | 271 | ALC40(1)391BC200 |
| 200 | 470 | BD | 25 x 40 | 1.45 | 2.19 | 320 | 224 | ALC40(1)471BD200 |
| 200 | 470 | CB | 30 x 30 | 1.24 | 1.76 | 369 | 270 | ALC40(1)471CB200 |
| 200 | 560 | CC | 30 x 35 | 1.50 | 2.13 | 301 | 219 | ALC40(1)561CC200 |
| 200 | 680 | CD | 30 x 40 | 1.72 | 2.44 | 249 | 181 | ALC40(1)681CD200 |
| 200 | 680 | EB | 40 x 30 | 2.97 | 3.67 | 202 | 158 | ALC40(1)681EB200 |
| 200 | 820 | CF | 30 x 50 | 2.18 | 3.16 | 196 | 140 | ALC40(1)821CF200 |
| 200 | 820 | DC | 35 x 35 | 1.70 | 2.34 | 252 | 191 | ALC40(1)821DC200 |
| 200 | 820 | EC | 40 x 35 | 3.35 | 4.06 | 173 | 137 | ALC40(1)821EC200 |
| 200 | 1000 | DD | 35 x 40 | 1.95 | 2.69 | 208 | 158 | ALC40(1)102DD200 |
| 200 | 1000 | ED | 40 x 40 | 3.92 | 4.80 | 140 | 110 | ALC40(1)102ED200 |
| 200 | 1200 | DF | 35 x 50 | 2.50 | 3.48 | 159 | 119 | ALC40(1)122DF200 |
| 200 | 1200 | EE | 40 x 45 | 4.50 | 5.50 | 116 | 91 | ALC40(1)122EE200 |
| 200 | 1500 | EF | 40 x 50 | 5.13 | 6.23 | 94 | 74 | ALC40(1)152EF200 |
| 200 | 1800 | EH | 40 x 60 | 6.10 | 7.53 | 76 | 60 | ALC40(1)182EH200 |
| 200 | 2700 | EL | 40 x 80 | 7.62 | 9.32 | 52 | 41 | ALC40(1)272EL200 |
| 200 | 3900 | EP | 40 x 105 | 7.90 | 12.31 | 49 | 34 | ALC40(1)392EP200 |
| 200 | 5600 | FP | 45 x 105 | 8.68 | 12.54 | 40 | 28 | ALC40(1)562FP200 |
| 200 | 6800 | KP | 50 x 105 | 9.08 | 12.29 | 36 | 26 | ALC40(1)682KP200 |
| 250 | 220 | BB | 25 x 30 | 0.93 | 1.50 | 592 | 405 | ALC40(1)221BB250 |
| 250 | 270 | BC | 25 x 35 | 1.10 | 1.77 | 480 | 327 | ALC40(1)271BC250 |
| 250 | 330 | BD | 25 x 40 | 1.29 | 2.08 | 393 | 268 | ALC40(1)331BD250 |
| 250 | 330 | CB | 30 x 30 | 1.13 | 1.69 | 441 | 312 | ALC40(1)331CB250 |
| 250 | 390 | CC | 30 x 35 | 1.36 | 2.04 | 364 | 256 | ALC40(1)391CC250 |
| 250 | 470 | CD | 30 x 40 | 1.56 | 2.34 | 302 | 212 | ALC40(1)471CD250 |
| 250 | 470 | EB | 40 x 30 | 2.59 | 3.49 | 258 | 193 | ALC40(1)471EB250 |
| 250 | 560 | CF | 30 x 50 | 1.96 | 3.02 | 243 | 168 | ALC40(1)561CF250 |
| 250 | 560 | DC | 35 x 35 | 1.57 | 2.25 | 297 | 217 | ALC40(1)561DC250 |
| 250 | 560 | EC | 40 x 35 | 3.05 | 4.16 | 221 | 166 | ALC40(1)561EC250 |
| 250 | 680 | DD | 35 x 40 | 1.80 | 2.59 | 245 | 179 | ALC40(1)681DD250 |
| 250 | 680 | ED | 40 x 40 | 3.49 | 4.76 | 180 | 134 | ALC40(1)681ED250 |
| 250 | 820 | DF | 35 x 50 | 3.12 | 4.66 | 190 | 137 | ALC40(1)821DF250 |
| 250 | 820 | EE | 40 x 45 | 4.01 | 5.46 | 149 | 111 | ALC40(1)821EE250 |
| 250 | 1000 | DH | 35 x 60 | 3.61 | 5.78 | 164 | 125 | ALC40(1)102DH250 |
| 250 | 1000 | EF | 40 x 50 | 4.58 | 6.22 | 123 | 92 | ALC40(1)102EF250 |
| 250 | 1200 | EG | 40 x 55 | 4.93 | 6.51 | 106 | 80 | ALC40(1)122EG250 |
| 250 | 1500 | DL | 35 x 80 | 4.43 | 6.88 | 112 | 90 | ALC40(1)152DL250 |
| 250 | 1800 | EL | 40 x 80 | 6.77 | 9.27 | 67 | 50 | ALC40(1)182EL250 |
| 250 | 2700 | EP | 40 x 105 | 7.05 | 12.03 | 62 | 42 | ALC40(1)272EP250 |
| 250 | 3900 | FP | 45 x 105 | 7.90 | 12.43 | 50 | 33 | ALC40(1)392FP250 |
| 250 | 4700 | KP | 50 x 105 | 8.36 | 12.30 | 44 | 30 | ALC40(1)472KP250 |
| 350 | 120 | BB | 25 x 30 | 0.88 | 2.07 | 868 | 562 | ALC40(1)121BB350 |
| 350 | 150 | BC | 25 x 35 | 1.04 | 2.46 | 694 | 449 | ALC40(1)151BC350 |
| 350 | 180 | BD | 25 x 40 | 1.20 | 2.81 | 578 | 374 | ALC40(1)181BD350 |

(1) Termination code: See Termination Tables for available options.

Table 1 – Ratings & Part Number Reference cont.

| VDC | Rated Capacitance | Size Code | Case Size | Ripple Current | | ESR Maximum | Impedance Maximum | Part Number |
|-----|---------------------|-----------|------------|---------------------|---------------------|---------------------|---------------------|------------------|
| | 100 Hz 20°C (µF) | | D x L (mm) | 100 Hz 105°C (A) | 10 kHz 105°C (A) | 100 Hz 20°C (mΩ) | 10 kHz 20°C (mΩ) | |
| 350 | 180 | CB | 30 x 30 | 1.17 | 2.46 | 618 | 410 | ALC40(1)181CB350 |
| 350 | 220 | CC | 30 x 35 | 1.36 | 2.88 | 502 | 332 | ALC40(1)221CC350 |
| 350 | 270 | CD | 30 x 40 | 1.59 | 3.33 | 410 | 272 | ALC40(1)271CD350 |
| 350 | 270 | EB | 40 x 30 | 1.97 | 4.36 | 448 | 291 | ALC40(1)271EB350 |
| 350 | 330 | DC | 35 x 35 | 1.79 | 3.24 | 378 | 260 | ALC40(1)331DC350 |
| 350 | 390 | CF | 30 x 50 | 2.02 | 4.02 | 287 | 191 | ALC40(1)391CF350 |
| 350 | 390 | DD | 35 x 40 | 2.02 | 3.67 | 317 | 218 | ALC40(1)391DD350 |
| 350 | 390 | ED | 40 x 40 | 2.64 | 5.73 | 312 | 203 | ALC40(1)391ED350 |
| 350 | 470 | DF | 35 x 50 | 2.72 | 4.90 | 251 | 170 | ALC40(1)471DF350 |
| 350 | 470 | EE | 40 x 45 | 3.00 | 6.46 | 258 | 168 | ALC40(1)471EE350 |
| 350 | 560 | DF | 35 x 50 | 2.57 | 4.44 | 224 | 155 | ALC40(1)561DF350 |
| 350 | 560 | DH | 35 x 60 | 3.11 | 5.70 | 224 | 155 | ALC40(1)561DH350 |
| 350 | 560 | EF | 40 x 50 | 3.41 | 7.27 | 216 | 141 | ALC40(1)561EF350 |
| 350 | 680 | EH | 40 x 60 | 3.99 | 8.39 | 177 | 114 | ALC40(1)681EH350 |
| 350 | 820 | DL | 35 x 80 | 3.82 | 6.72 | 150 | 102 | ALC40(1)821DL350 |
| 350 | 1000 | EL | 40 x 80 | 5.00 | 9.98 | 120 | 78 | ALC40(1)102EL350 |
| 350 | 1500 | EP | 40 x 105 | 6.00 | 11.47 | 99 | 68 | ALC40(1)152EP350 |
| 350 | 2200 | FP | 45 x 105 | 6.79 | 12.06 | 77 | 53 | ALC40(1)222FP350 |
| 350 | 2700 | KP | 50 x 105 | 7.34 | 12.08 | 66 | 45 | ALC40(1)272KP350 |
| 400 | 100 | BB | 25 x 30 | 0.85 | 2.09 | 1193 | 788 | ALC40(1)101BB400 |
| 400 | 120 | BC | 25 x 35 | 1.00 | 2.45 | 991 | 653 | ALC40(1)121BC400 |
| 400 | 150 | BD | 25 x 40 | 1.17 | 2.83 | 794 | 524 | ALC40(1)151BD400 |
| 400 | 150 | CB | 30 x 30 | 1.14 | 2.46 | 835 | 562 | ALC40(1)151CB400 |
| 400 | 180 | CC | 30 x 35 | 1.31 | 2.88 | 690 | 463 | ALC40(1)181CC400 |
| 400 | 220 | CD | 30 x 40 | 1.54 | 3.33 | 565 | 379 | ALC40(1)221CD400 |
| 400 | 220 | EB | 40 x 30 | 1.88 | 4.36 | 521 | 320 | ALC40(1)221EB400 |
| 400 | 270 | DC | 35 x 35 | 1.73 | 3.23 | 470 | 322 | ALC40(1)271DC400 |
| 400 | 270 | EC | 40 x 35 | 2.21 | 4.95 | 430 | 266 | ALC40(1)271EC400 |
| 400 | 330 | CF | 30 x 50 | 1.98 | 4.02 | 383 | 258 | ALC40(1)331CF400 |
| 400 | 330 | DD | 35 x 40 | 1.98 | 3.64 | 386 | 266 | ALC40(1)331DD400 |
| 400 | 330 | ED | 40 x 40 | 2.56 | 5.76 | 350 | 216 | ALC40(1)331ED400 |
| 400 | 390 | DF | 35 x 50 | 2.64 | 4.66 | 323 | 221 | ALC40(1)391DF400 |
| 400 | 390 | EE | 40 x 45 | 2.88 | 6.48 | 295 | 182 | ALC40(1)391EE400 |
| 400 | 470 | DE | 35 x 45 | 2.50 | 4.73 | 300 | 192 | ALC40(1)471DE400 |
| 400 | 470 | DF | 35 x 50 | 2.51 | 4.40 | 277 | 192 | ALC40(1)471DF400 |
| 400 | 470 | DH | 35 x 60 | 3.04 | 5.78 | 270 | 185 | ALC40(1)471DH400 |
| 400 | 470 | EF | 40 x 50 | 3.28 | 7.30 | 245 | 151 | ALC40(1)471EF400 |
| 400 | 560 | EG | 40 x 55 | 3.62 | 7.78 | 209 | 130 | ALC40(1)561EG400 |
| 400 | 680 | DL | 35 x 80 | 3.72 | 6.69 | 200 | 131 | ALC40(1)681DL400 |
| 400 | 680 | EH | 40 x 60 | 4.08 | 8.58 | 173 | 107 | ALC40(1)681EH400 |
| 400 | 1000 | EL | 40 x 80 | 4.85 | 10.16 | 118 | 73 | ALC40(1)102EL400 |
| 400 | 1200 | EP | 40 x 105 | 5.76 | 11.46 | 103 | 70 | ALC40(1)122EP400 |
| 400 | 1800 | FP | 45 x 105 | 6.48 | 12.04 | 82 | 55 | ALC40(1)182FP400 |
| 400 | 2200 | KP | 50 x 105 | 7.02 | 12.08 | 70 | 47 | ALC40(1)222KP400 |
| 450 | 47 | BB | 25 x 30 | 0.66 | 1.74 | 2011 | 1392 | ALC40(1)470BB450 |
| 450 | 56 | BC | 25 x 35 | 0.76 | 2.03 | 1687 | 1168 | ALC40(1)560BC450 |
| 450 | 68 | BD | 25 x 40 | 0.88 | 2.34 | 1391 | 963 | ALC40(1)680BD450 |
| 450 | 68 | CB | 30 x 30 | 0.87 | 2.19 | 1403 | 974 | ALC40(1)680CB450 |
| 450 | 82 | CC | 30 x 35 | 1.01 | 2.54 | 1163 | 807 | ALC40(1)820CC450 |
| 450 | 100 | CD | 30 x 40 | 1.18 | 2.95 | 955 | 663 | ALC40(1)101CD450 |
| 450 | 120 | DC | 35 x 35 | 1.36 | 3.11 | 810 | 565 | ALC40(1)121DC450 |
| 450 | 150 | CF | 30 x 50 | 1.54 | 3.67 | 642 | 446 | ALC40(1)151CF450 |
| 450 | 150 | DD | 35 x 40 | 1.57 | 3.53 | 651 | 454 | ALC40(1)151DD450 |
| 450 | 150 | EB | 40 x 30 | 1.73 | 4.14 | 642 | 447 | ALC40(1)151EB450 |
| 450 | 180 | DF | 35 x 50 | 1.88 | 4.27 | 541 | 377 | ALC40(1)181DF450 |
| 450 | 180 | EC | 40 x 35 | 2.01 | 4.70 | 538 | 374 | ALC40(1)181EC450 |
| 450 | 220 | DF | 35 x 50 | 2.28 | 4.71 | 449 | 315 | ALC40(1)221DF450 |
| 450 | 220 | ED | 40 x 40 | 2.34 | 5.47 | 440 | 306 | ALC40(1)221ED450 |
| 450 | 270 | EF | 40 x 50 | 2.80 | 6.74 | 356 | 248 | ALC40(1)271EF450 |
| VDC | Rated Capacitance | Size Code | Case Size | Ripple Current | | ESR | Impedance | Part Number |

(1) Termination code: See Termination Tables for available options.

Table 1 – Ratings & Part Number Reference cont.

| VDC | Rated Capacitance | Size Code | Case Size | Ripple Current | | ESR Maximum | Impedance Maximum | Part Number |
|-----|---------------------|-----------|------------|---------------------|---------------------|---------------------|---------------------|------------------|
| | 100 Hz 20°C (µF) | | D x L (mm) | 100 Hz 105°C (A) | 10 kHz 105°C (A) | 100 Hz 20°C (mΩ) | 10 kHz 20°C (mΩ) | |
| 450 | 330 | DF | 35 x 50 | 2.53 | 5.14 | 206 | 140 | ALC40(1)331DF450 |
| 450 | 330 | DH | 35 x 60 | 2.91 | 5.53 | 285 | 198 | ALC40(1)331DH450 |
| 450 | 330 | EG | 40 x 55 | 3.14 | 7.29 | 293 | 204 | ALC40(1)331EG450 |
| 450 | 390 | EH | 40 x 60 | 3.50 | 8.04 | 249 | 174 | ALC40(1)391EH450 |
| 450 | 470 | DH | 35 X 60 | 3.00 | 5.82 | 232 | 148 | ALC40(1)471DH450 |
| 450 | 470 | DL | 35 x 80 | 3.51 | 6.68 | 203 | 138 | ALC40(1)471DL450 |
| 450 | 560 | EL | 40 x 80 | 4.32 | 9.57 | 175 | 122 | ALC40(1)561EL450 |
| 450 | 820 | EL | 40 X 80 | 4.30 | 10.04 | 154 | 98 | ALC40(1)821EL450 |
| 450 | 820 | EP | 40 x 105 | 5.34 | 11.05 | 121 | 85 | ALC40(1)821EP450 |
| 450 | 1200 | FP | 45 x 105 | 5.84 | 11.64 | 105 | 71 | ALC40(1)122FP450 |
| 450 | 1500 | KP | 50 x 105 | 6.44 | 11.85 | 86 | 59 | ALC40(1)152KP450 |
| 500 | 56 | BB | 25 x 30 | 0.75 | 1.58 | 3930 | 3170 | ALC40(1)560BB500 |
| 500 | 68 | BC | 25 x 35 | 0.85 | 1.81 | 3240 | 2610 | ALC40(1)680BC500 |
| 500 | 82 | BD | 25 x 40 | 0.97 | 2.05 | 2690 | 2170 | ALC40(1)820BD500 |
| 500 | 82 | CB | 30 x 30 | 1.00 | 2.03 | 2700 | 2180 | ALC40(1)820CB500 |
| 500 | 120 | CC | 30 x 35 | 1.26 | 2.51 | 1850 | 1500 | ALC40(1)121CC500 |
| 500 | 150 | DC | 35 x 35 | 1.51 | 2.88 | 1500 | 1210 | ALC40(1)151DC500 |
| 500 | 180 | CF | 30 x 50 | 1.67 | 3.34 | 1230 | 1000 | ALC40(1)181CF500 |
| 500 | 180 | DD | 35 x 40 | 1.71 | 3.26 | 1250 | 1010 | ALC40(1)181DD500 |
| 500 | 180 | EB | 40 x 30 | 1.77 | 3.55 | 1250 | 1010 | ALC40(1)181EB500 |
| 500 | 220 | EC | 40 x 35 | 2.03 | 4.09 | 1020 | 820 | ALC40(1)221EC500 |
| 500 | 270 | DF | 35 x 50 | 2.20 | 4.06 | 840 | 680 | ALC40(1)271DF500 |
| 500 | 270 | ED | 40 x 40 | 2.32 | 4.66 | 830 | 670 | ALC40(1)271ED500 |
| 500 | 330 | DH | 35 x 60 | 2.52 | 4.62 | 690 | 560 | ALC40(1)331DH500 |
| 500 | 390 | EF | 40 x 50 | 2.94 | 5.81 | 580 | 470 | ALC40(1)391EF500 |
| 500 | 470 | DL | 35 x 80 | 3.14 | 5.61 | 480 | 390 | ALC40(1)471DL500 |
| 500 | 470 | EG | 40 x 55 | 3.30 | 6.42 | 480 | 390 | ALC40(1)471EG500 |
| 500 | 680 | EL | 40 x 80 | 4.25 | 8.14 | 330 | 270 | ALC40(1)681EL500 |
| 500 | 820 | EP | 40 x 105 | 4.71 | 8.95 | 280 | 220 | ALC40(1)821EP500 |
| 500 | 1000 | FP | 45 x 105 | 5.52 | 10.08 | 230 | 190 | ALC40(1)102FP500 |
| 500 | 1200 | KP | 50 x 105 | 6.27 | 11.00 | 190 | 160 | ALC40(1)122KP500 |
| VDC | Rated Capacitance | Size Code | Case Size | Ripple Current | | ESR | Impedance | Part Number |

(1) Termination code: See Termination Tables for available options.

Mechanical Data

Polarity and Reversed Voltage

Aluminium Electrolytic capacitors manufactured for use in DC applications contain an anode foil and a cathode foil. As such, they are polarized devices and must be connected with the +ve to the anode foil and the -ve to the cathode foil. If this were to be reversed then the electrolytic process that took place in forming the oxide layer on the anode would be recreated in trying to form an oxide layer on the cathode. In forming the cathode foil in this way, heat would be generated and gas given off within the capacitor, usually leading to catastrophic failure.

The cathode foil already possesses a thin stabilized oxide layer. This thin oxide layer is equivalent to a forming voltage of approximately 2 V. As a result, the capacitor can withstand a voltage reversal of up to 2 V for short periods. Above this voltage, the formation process will commence. Aluminium Electrolytic capacitors can also be manufactured for use in intermittent AC applications by using two anode foils in place of one anode and one cathode.

Mounting Position

The capacitor can be mounted upright or inclined to a horizontal position.

Insulating Resistance

≥ 100 MΩ at 100 VDC across insulating sleeve. UL recognized sleeving is available for custom parts in this range, upon request.

(UL No. E358957)

Voltage Proof

≥ 2,500 VDC across insulating sleeve.

Safety Vent

A safety vent for overpressure is featured on either the base (opposing end to the terminals) or the side of the can. This appears in the form of a grooved section on the surface of the can, which is a weakened area and designed to relieve build-up of internal pressure due to overstress or catastrophic failure.

Marking

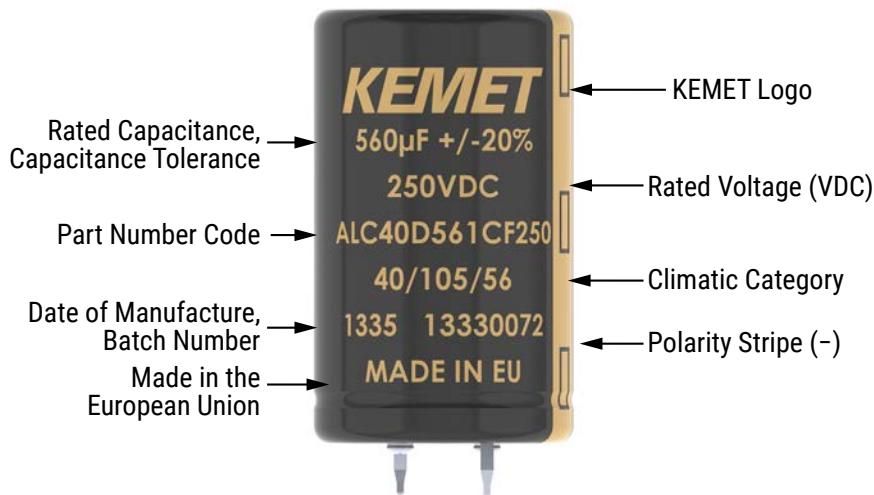

Construction

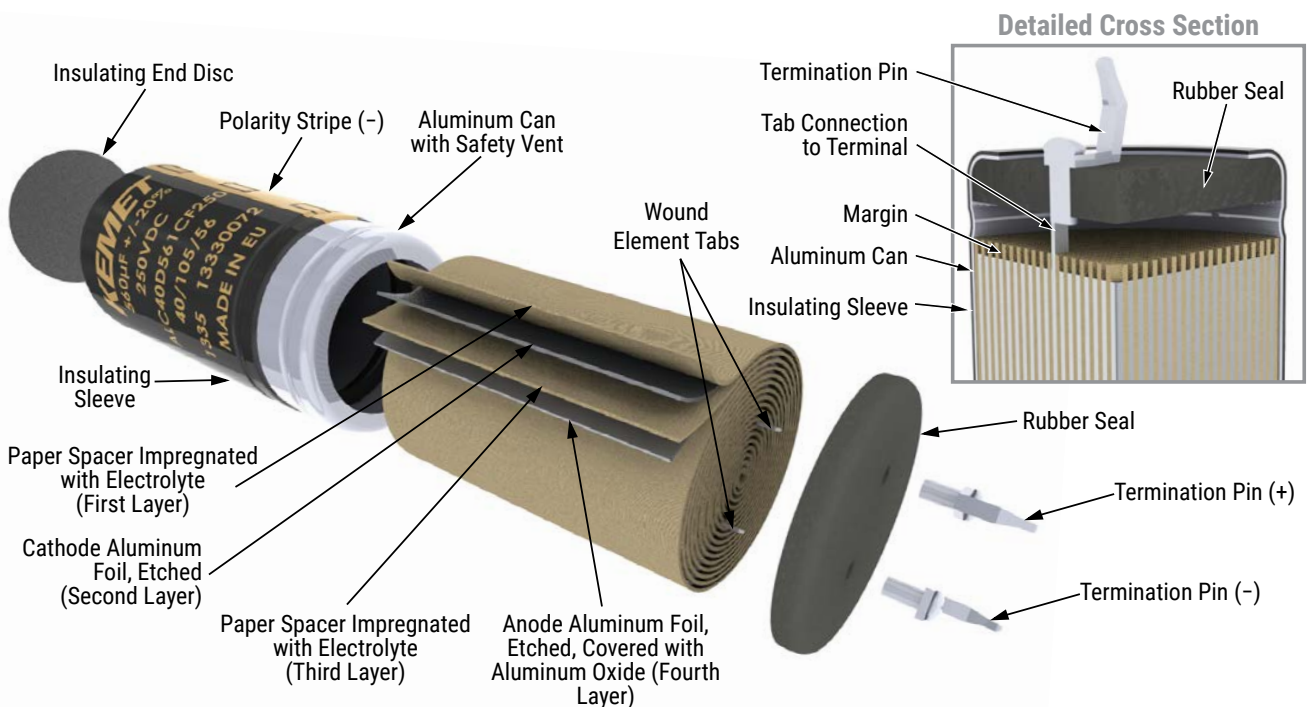

Construction Data

The manufacturing process begins with the anode foil being electrochemically etched to increase the surface area and then “formed” to produce the aluminum oxide layer. Both the anode and cathode foils are then interleaved with absorbent paper and wound into a cylinder. During the winding process, aluminum tabs are attached to each foil to provide the electrical contact.

The deck, complete with terminals, is attached to the tabs and then folded down to rest on top of the winding. The complete winding is impregnated with electrolyte before being housed in a suitable container, usually an aluminum can, and sealed. Throughout the process, all materials inside the housing must be maintained at the highest purity and be compatible with the electrolyte.

Each capacitor is aged and tested before being sleeved and packed. The purpose of aging is to repair any damage in the oxide layer and thus reduce the leakage current to a very low level. Aging is normally carried out at the rated temperature of the capacitor and is accomplished by applying voltage to the device while carefully controlling the supply current. The process may take several hours to complete.

Damage to the oxide layer can occur due to variety of reasons:

- Slitting of the anode foil after forming
- Attaching the tabs to the anode foil
- Minor mechanical damage caused during winding

A sample from each batch is taken by the quality department after completion of the production process. This sample size is controlled by the use of recognized sampling tables defined in BS 6001.

The following tests are applied and may be varied at the request of the customer. In this case the batch, or special procedure, will determine the course of action.

Electrical:

- Leakage current
- Capacitance
- ESR
- Impedance
- Tan Delta

Mechanical/Visual:

- Overall dimensions
- Torque test of mounting stud
- Print detail
- Box labels
- Packaging, including packed quantity



KEMET Electronics Corporation Sales Offices

For a complete list of our global sales offices, please visit www.kemet.com/sales.

Disclaimer

All product specifications, statements, information and data (collectively, the "Information") in this datasheet are subject to change. The customer is responsible for checking and verifying the extent to which the Information contained in this publication is applicable to an order at the time the order is placed. All Information given herein is believed to be accurate and reliable, but it is presented without guarantee, warranty, or responsibility of any kind, expressed or implied.

Statements of suitability for certain applications are based on KEMET Electronics Corporation's ("KEMET") knowledge of typical operating conditions for such applications, but are not intended to constitute – and KEMET specifically disclaims – any warranty concerning suitability for a specific customer application or use. The Information is intended for use only by customers who have the requisite experience and capability to determine the correct products for their application. Any technical advice inferred from this Information or otherwise provided by KEMET with reference to the use of KEMET's products is given gratis, and KEMET assumes no obligation or liability for the advice given or results obtained.

Although KEMET designs and manufactures its products to the most stringent quality and safety standards, given the current state of the art, isolated component failures may still occur. Accordingly, customer applications which require a high degree of reliability or safety should employ suitable designs or other safeguards (such as installation of protective circuitry or redundancies) in order to ensure that the failure of an electrical component does not result in a risk of personal injury or property damage.

Although all product-related warnings, cautions and notes must be observed, the customer should not assume that all safety measures are indicated or that other measures may not be required.

KEMET is a registered trademark of KEMET Electronics Corporation.

Mouser Electronics

Authorized Distributor

Click to View Pricing, Inventory, Delivery & Lifecycle Information:

KEMET:

[ALC40A331DF450](#) [ALC40A471DE400](#) [ALC40A471DH450](#) [ALC40A561DH400](#) [ALC40A561DL450](#)
[ALC40A681DL450](#) [ALC40C102FL450](#) [ALC40C152FP450](#) [ALC40C821EJ400](#) [ALC40C821EL450](#) [ALC40A1046CF](#)
[ALC40A822DD063](#) [ALC40A102BC100](#) [ALC40A391BC200](#) [ALC40A471CB200](#) [ALC40A122DF200](#) [ALC40A221BB250](#)
[ALC40A331BD250](#) [ALC40A331CB250](#) [ALC40A681DD250](#) [ALC40A151BC350](#) [ALC40A221CC350](#)
[ALC40A331DC350](#) [ALC40A471DF350](#) [ALC40A101BB400](#) [ALC40A221CD400](#) [ALC40A331CF400](#)
[ALC40A331DD400](#) [ALC40A471DF400](#) [ALC40A681DL400](#) [ALC40A101CD450](#) [ALC40A221DF450](#) [ALC40C471DF400](#)
[ALC40C102EL400](#) [ALC40A221AB200](#) [ALC40A272AB040](#) [ALC40A332AD040](#) [ALC40A102DL400](#)
[ALC40A333EC025](#) [ALC40D153EH063](#) [ALC40D332BC063](#) [ALC40D152EF200](#) [ALC40D103BC025](#)
[ALC40D221EB400](#) [ALC40D682CF063](#) [ALC40D562CD063](#) [ALC40D101CD450](#) [ALC40D152CC100](#)
[ALC40D392BD063](#) [ALC40D681DL400](#) [ALC40D821EL450](#) [ALC40A221EC500](#) [ALC40A102EL400](#) [ALC40A222DC100](#)
[ALC40A680CB450](#) [ALC40A151CB400](#) [ALC40A562CD063](#) [ALC40A103DF063](#) [ALC40A391EH450](#)
[ALC40A681EH400](#) [ALC40C102ED200](#) [ALC40D680CB450](#) [ALC40G471EG500](#) [ALC40C681DL400](#) [ALC40A1045DD](#)