

## Small Round Water-resistive Connectors

- Water-resistive, compact connector meets IP67 requirements.
- Conventional M8 screw-mounting models are available along with S8 snap-in models that connect and disconnect with one touch.
- Ideal for a wide variety of FA and OA applications.
- Connectors on both cable ends require no harness work.
- Vibration-proof robot cable provided as a standard feature.



 Refer to *Safety Precautions* on page 9.

### Ratings and Specifications

Item	Model	XS3F/H/P/M	XS3R
Rated current		1 A	
Rated voltage		125 VDC	
Contact resistance (connector)		40 MΩ max. (20 mV max., 100 mA max.)	60 mΩ max. (20 mVDC max., 100 mA max.)
Insulation resistance		1,000 MΩ min. (at 500 VDC)	
Dielectric strength (connector)		1,000 VAC for 1 min (leakage current: 1 mA max.)	
Degree of protection		IP67(IEC529)	
Insertion tolerance		200 times min.	
Cable tensile strength		50 N	
Ambient operating temperature range		-25°C to 70°C	

### Materials and Finish

Item	Model	XS3F/H/R	XS3P/M
Pin block		PBT resin (UL 94V-0) light gray or black	
Contacts		Phosphor bronze/ nickel base, 0.4- μm gold plating	Brass/nickel base, 0.4-μm gold plating
Thread bracket (M8) Shell (S8)		Brass/nickel plating or SUS316L.	
Cover		PBT resin (UL 94V-0)	
O-ring		Rubber	

### Pin Arrangement (Engaged Side)

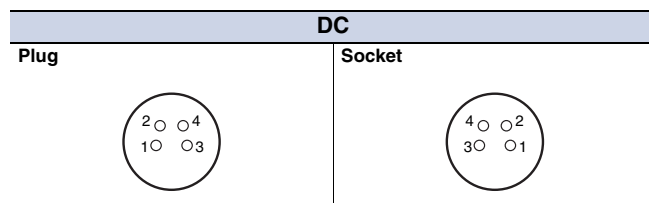

# XS3W

● M8 Screw-mounting Connectors with Vibration-proof Robot Cable

XS3W-M42□-4□□-R

## Dimensions

(Unit: mm)

### Straight/Straight Connectors

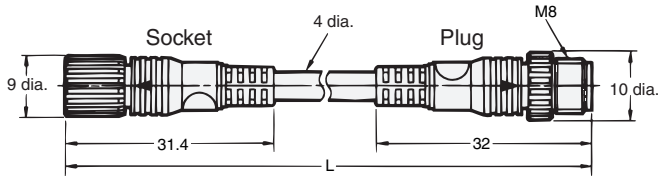

### Straight/L-shaped Connectors

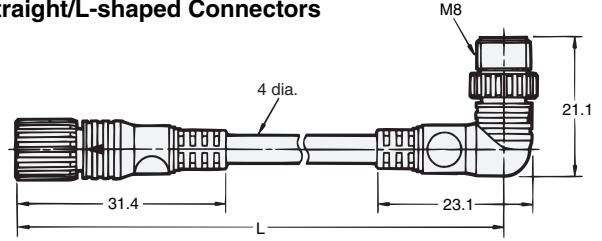

### L-shaped/L-shaped Connectors

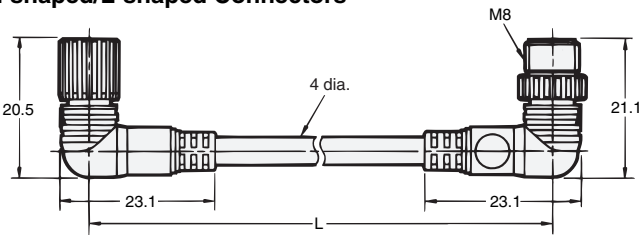

### L-shaped/Straight Connectors

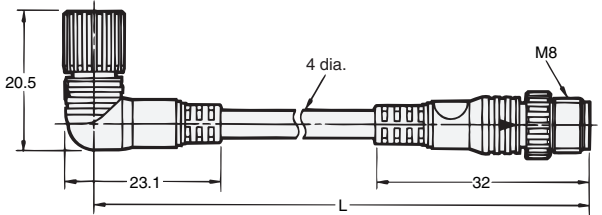

● S8 Snap-in Connectors with Vibration-proof Robot Cable

XS3W-S42□-4□□-R

## Dimensions

(Unit: mm)

### Straight/Straight Connectors

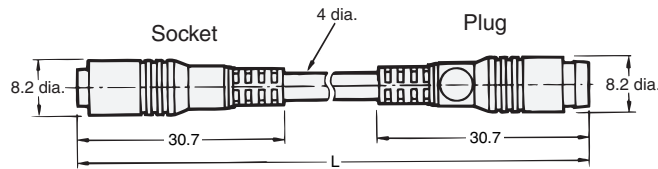

### Straight/L-shaped Connectors

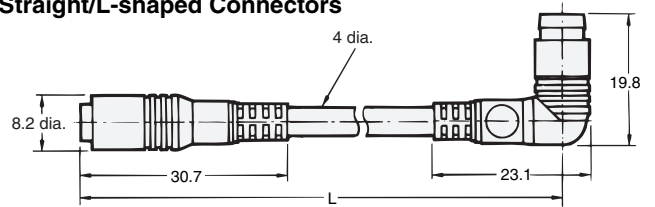

### L-shaped/L-shaped Connectors

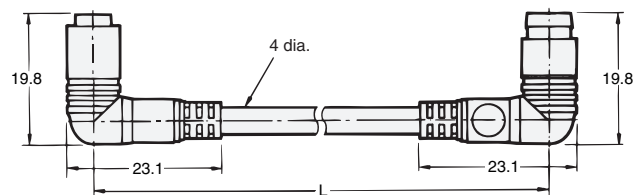

### L-shaped/Straight Connectors

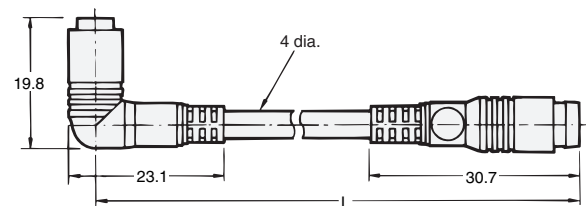

## Model Number Legend

Use this model number legend to identify products from their model number. When ordering, use a model number from the table in *Ordering Information*.

**XS3W-□42□-4□□-R**

1
2
3
4
5
6

- |   |  |  |  |
|---|--|--|--|
| <b>1. Fastening Method</b><br>M: M8<br>S: S | <b>3. Cable Connection Direction</b><br>1: Straight/straight<br>2: L-shaped/L-shaped<br>3: Straight (socket)/L-shaped (plug)<br>4: L-shaped (socket)/straight (plug) | <b>4. Connections</b><br>Pin No.<br>① ② ③ ④<br>4: Brown White Blue Black | <b>5. Cable Length</b><br>01: 1 m<br>02: 2 m<br>05: 5 m          |
| <b>2. Connector Poles</b><br>4: 4 poles     |  |  | <b>6. Cable Specifications</b><br>R: Vibration-proof robot cable |

## Wiring Diagram

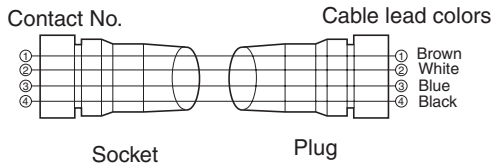

## Mating Connectors

Item	Socket side	Plug side
XS3W(M8)	XS3M (M8/S8) XS3H (M8)	XS3F(M8) XS3W(M8) XS3P(M8)
XS3W(S8)	XS3M (M8/S8) XS3H (M8)	XS3F(S8) XS3W(S8) XS3P(S8)

Note 1. Cables can be extended with more than one XS3W.  
 2. M8 screw models and S8 snap-in models cannot be connected to each other.

## Ordering Information

Item	Cable connection direction	No. of cable cores	Cable length L (m)	Model
M8 Connectors Vibration-proof robot cable	Straight/Straight	4	1	XS3W-M421-401-R
			2	XS3W-M421-402-R
			5	XS3W-M421-405-R
	L-shaped/L-shaped		2	XS3W-M422-402-R
			5	XS3W-M422-405-R
			2	XS3W-M423-402-R
	L-shaped/Straight		5	XS3W-M423-405-R
			2	XS3W-M424-402-R
5		XS3W-M424-405-R		
2		XS3W-S421-401-R		
S8 Connectors Vibration-proof robot cable	Straight/Straight	4	2	XS3W-S421-402-R
			5	XS3W-S421-405-R
			2	XS3W-S422-402-R
	L-shaped/L-shaped		5	XS3W-S422-405-R
			2	XS3W-S423-402-R
			5	XS3W-S423-405-R
	L-shaped/Straight		2	XS3W-S424-402-R
			5	XS3W-S424-405-R

# XS3F Sockets on One Cable End

● M8 Screw-on Cables with Vibration-proof Robot Cable/Standard Cable

XS3F-□42□-4□□-□

## Dimensions

(Unit: mm)

### Straight Connectors

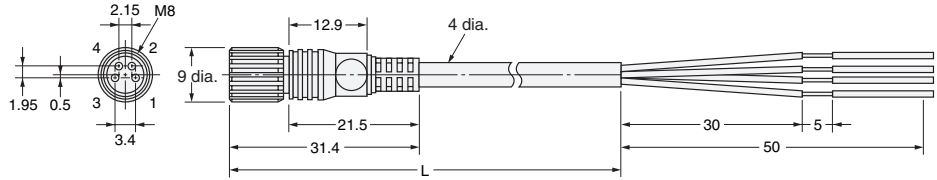

### L-shaped Connectors

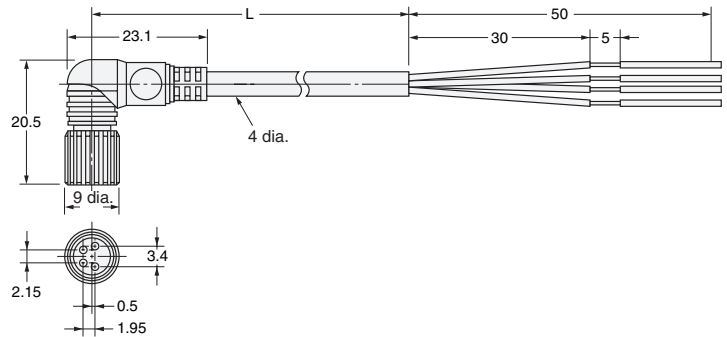
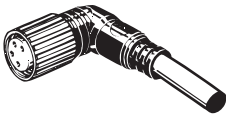

● S8 Snap-in Connectors with Vibration-proof Robot Cable

XS3F-S42□-4□□-R

## Dimensions

(Unit: mm)

### Straight Connectors

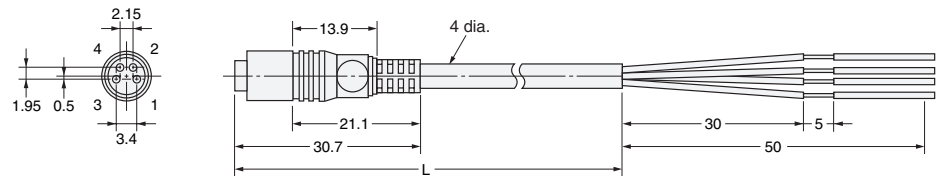

### L-shaped Connectors

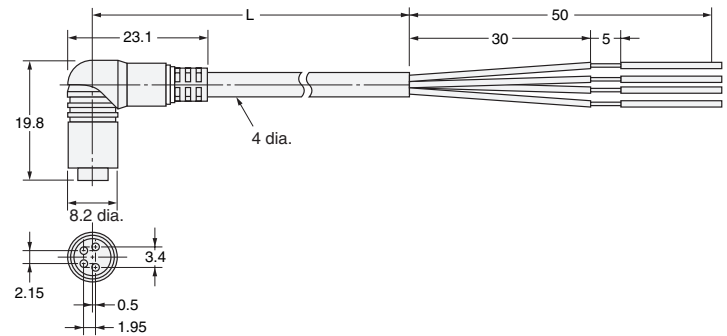

## Model Number Legend

Use this model number legend to identify products from their model number. When ordering, use a model number from the table in *Ordering Information*.

**XS3F-** **42** **-4**  **-** 

1 2
3 4 5
6

### 1. Fastening Method

M: M8  
 S: S8  
 E: M8  
 SUS316L Lock

### 2. Connector Poles

4: 4 poles

### 3. Cable Connection Direction

1: Straight  
 2: L-shaped

### 4. Connections

Pin No.  
①
②
③
④  
 4: Brown White Blue Black

### 5. Cable Length

01: 1 m  
 02: 2 m  
 05: 5 m

### 6. Cable Specifications

A: Standard cable  
 R: Vibration-proof robot cable

## Wiring Diagram

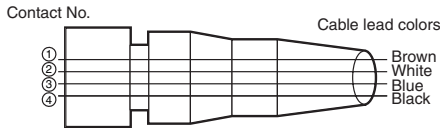

## Mating Connectors

Item	Model
XS3F(M8)	XS3M (M8/S8), XS3H (M8), XS3W (M8)
XS3F(S8)	XS3M (M8/S8), XS3H (M8), XS3W (M8)

Note: M8 screw models and S8 snap-in models cannot be connected to each other.

## Ordering Information

### M8 Models

Item	Cable connection direction	No. of cable cores	Cable length L (m)	Model
Standard cable	Straight	4	2	XS3F-M421-402-A
			5	XS3F-M421-405-A
	L-shaped		2	XS3F-M422-402-A
			5	XS3F-M422-405-A
Vibration-proof robot cable	Straight	4	1	XS3F-M421-401-R
			2	XS3F-M421-402-R
			5	XS3F-M421-405-R
	L-shaped		1	XS3F-M422-401-R
			2	XS3F-M422-402-R
			5	XS3F-M422-405-R
Standard SUS316L cable lock	Straight	4	2	XS3F-E421-402-A
			5	XS3F-E421-405-A
	L-shaped		2	XS3F-E422-402-A
			5	XS3F-E422-405-A

### S8 Models

Cable connection direction	No. of cable cores	Cable length (m)	Model
Straight	4	1	XS3F-S421-401-R
		2	XS3F-S421-402-R
		5	XS3F-S421-405-R
L-shaped		1	XS3F-S422-401-R
		2	XS3F-S422-402-R
		5	XS3F-S422-405-R

# XS3H Plugs on One Cable End

● M8 Screw-on Connectors with Vibration-proof Robot Cable

XS3H-M42□-4□□-R

## Dimensions

(Unit: mm)

### Straight Connectors

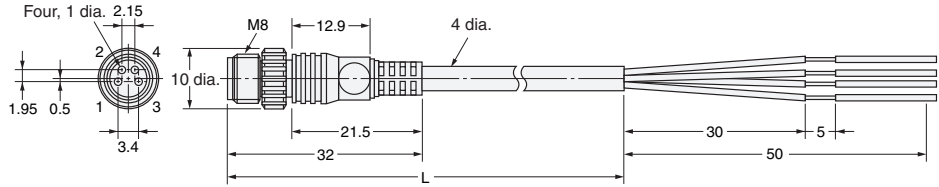
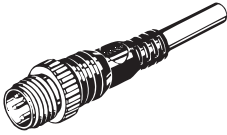

### L-shaped Connectors

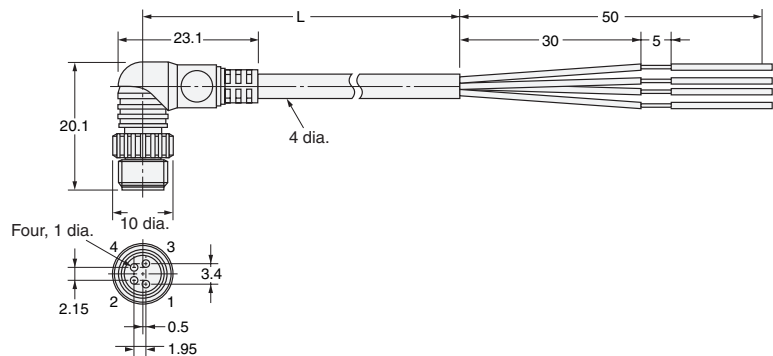
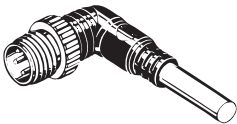

● S8 Snap-in Connectors with Vibration-proof Robot Cable

XS3H-S42□-4□□-R

## Dimensions

(Unit: mm)

### Straight Connectors

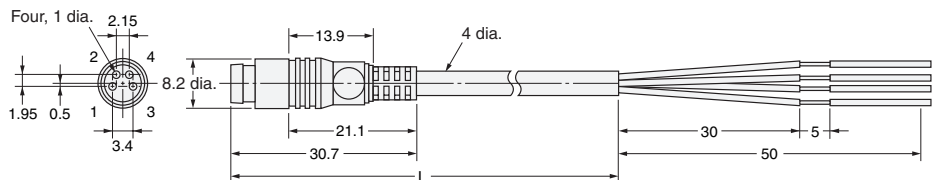

### L-shaped Connectors

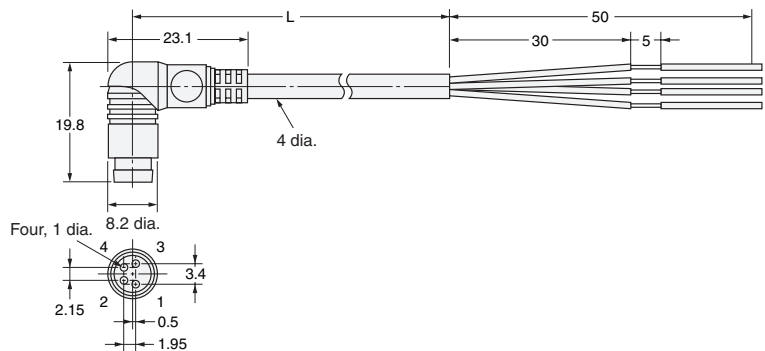

## Model Number Legend

Use this model number legend to identify products from their model number. When ordering, use a model number from the table in *Ordering Information*.

**XS3H-□42□-4□□-R**

1 2
3 4 5
6

### 1. Fastening Method

M: M8  
S: S8

### 2. Connector Poles

4: 4 poles

### 3. Cable Connection

#### Direction

1: Straight  
2: L-shaped

### 4. Connections

#### Pin No.

① ② ③ ④  
4: Brown White Blue Black

### 5. Cable Length

C3: 0.3 m  
01: 1 m

### 6. Cable Specifications

R: Vibration-proof robot cable

## Wiring Diagram

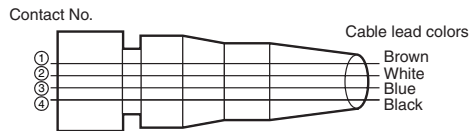

## Mating Connectors

Item	Model
XS3H(M8)	XS3F (M8), XS3W (M8), XS3P (M8)
XS3H(S8)	XS3F (S8), XS3W (S8), XS3P (S8)

Note: M8 screw models and S8 snap-in models cannot be connected to each other.

## Ordering Information

### M8 Model

Cable connection direction	No. of cable cores	Cable length L (m)	Model
Straight	4	0.3	XS3H-M421-4C3-R
		1	XS3H-M421-401-R
L-shaped		0.3	XS3H-M422-4C3-R
		1	XS3H-M422-401-R

### S8 Model

Cable connection direction	No. of cable cores	Cable length L (m)	Model
Straight	4	0.3	XS3H-S421-4C3-R
		1	XS3H-S421-401-R
L-shaped		0.3	XS3H-S422-4C3-R
		1	XS3H-S422-401-R

# XS3P Panel-mounting Sockets for Terminal Boxes

- M8 Screw-mounting Sockets with DIP Pins
- M8 Screw-mounting Sockets with Solder Cup Pins
- M8 Screw-mounting Sockets with Solder Cup Pins

**XS3P-M421-1**  
**XS3P-M421-2**  
**XS3P-M422-2**

## Dimensions

(Unit: mm)

### XS3P-M421-1 (DIP Pins)

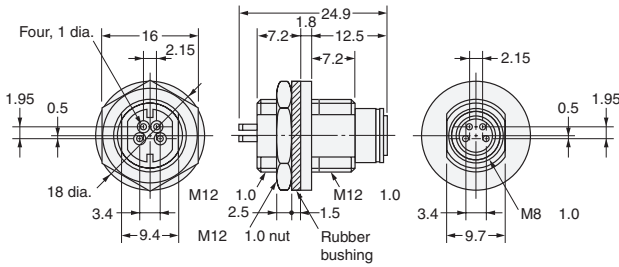

### XS3P-M421-2 (Solder Cup Pins)

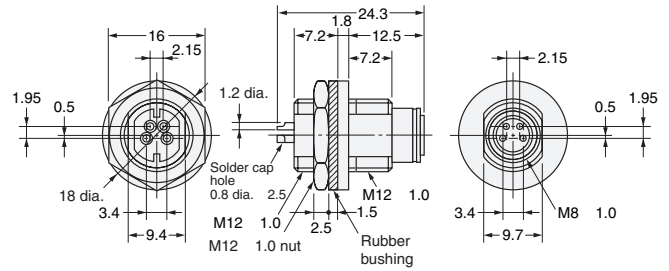

### XS3P-M422-2 (Solder Cup Pins), Rear Lock Slim Models

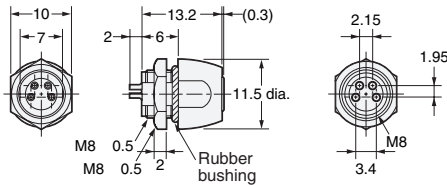

- S8 Snap-in Sockets with DIP Pins
- S8 Snap-in Sockets with Solder Cup Pins

**XS3P-S421-1**  
**XS3P-S421-2**

## Dimensions

(Unit: mm)

### XS3P-S421-1 (DIP Pins)

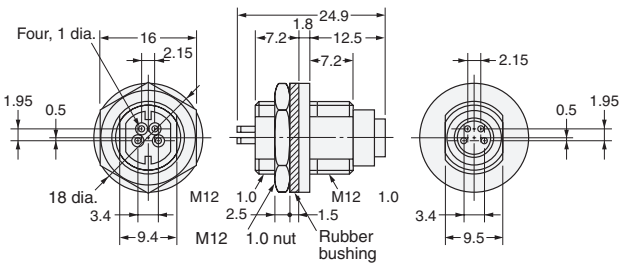

### XS3P-S421-2 (Solder Cup Pins)

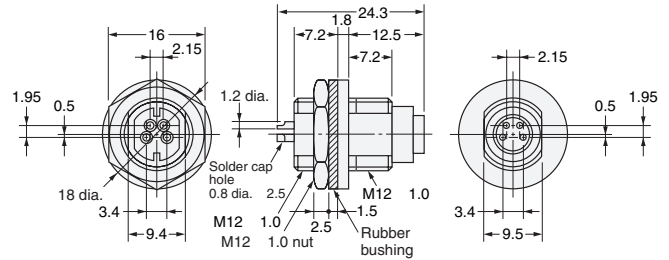



Mounting Dimensions for XS3P Screw-on Models and Snap-in Models

(Unit: mm)

Panel Cutouts

XS3P-□421

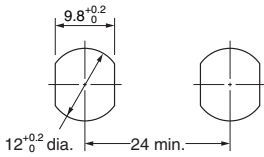

Note: The panel thickness is 1 to 3 mm.

XS3P-M422-2

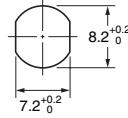

PCB-mounting Dimensions

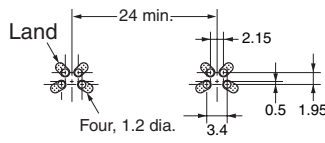

Note: The panel thickness is 2.4 mm maximum.

Panel-mounting Dimensions

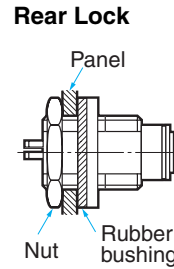

Front Lock

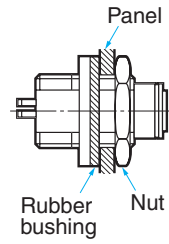

Mating Connectors

Item	Model
XS3P(M8)	XS3H (M8), XS3W (M8)
XS3P(S8)	XS3H (S8), XS3W (S8)

Note: M8 screw models and S8 snap-in models cannot be connected to each other.

Ordering Information

Connection method	Panel mounting	Pin shape	Model	Minimum order
M8 screw-mounting	Front lock or rear lock	DIP pins	XS3P-M421-1	50
		Solder cup pins	XS3P-M421-2	
	Rear lock	Solder cup pins	XS3P-M422-2	
S8 snap-in	Front lock or rear lock	DIP pins	XS3P-S421-1	
		Solder cup pins	XS3P-S421-2	

Note: Orders are accepted in multiples of the minimum order.

Safety Precautions

In addition to the following information, also refer to *Safety Precautions* on page 12

Precautions for Correct Use

Panel Mounting

- When mounting XS3P Panel-mounting Connectors to panels, refer to *Panel-mounting Dimensions* and provide rubber bushings and nuts for the Connectors. Apply a tightening torque of between 0.4 and 0.6 N·m to mount the Connectors.

# XS3M Sensor Embedded Plugs

- Embedded Plugs with Screw Threads and DIP Pins
- Embedded Plugs with Screw Threads and Solder Cup Pins

**XS3M-K421-1**  
**XS3M-K421-2**

## Dimensions

(Unit: mm)

### XS3M-K421-1

#### Embedded Model with DIP Pins

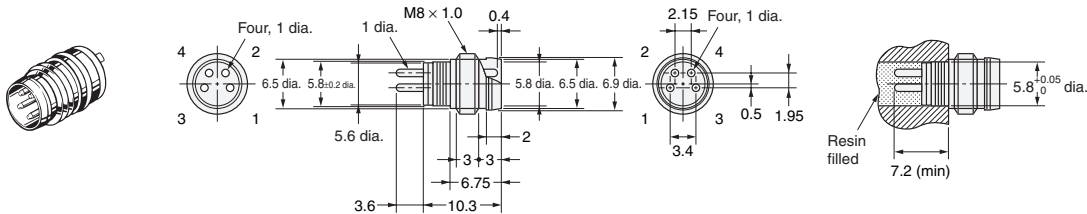

### XS3M-K421-2

#### Embedded Model with Solder Cup Pins

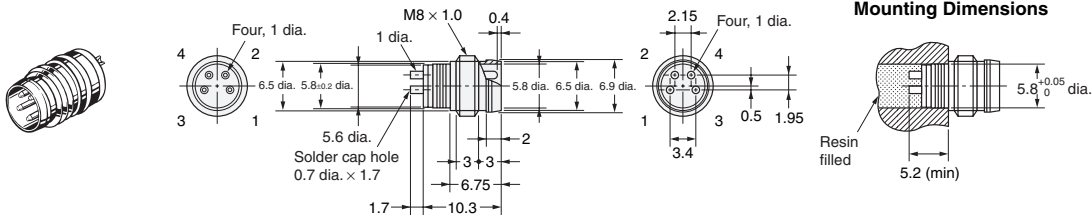

## Mating Connectors

Item	Model
XS3M	XS3F (M8/S8), XS3W (M8/S8)

Note: The plug can be connected to both M8 screw and S8 snap-in models.

## Ordering Information

Connection method	Pin shape	Model	Minimum order
Embedded model	DIP pins	<b>XS3M-K421-1</b>	200
	Solder cup pins	<b>XS3M-K421-2</b>	

Note: Orders are accepted in multiples of the minimum order.

## XS3 M8/S8 Connector Cover

### Dust Cover

#### XS3Z-13

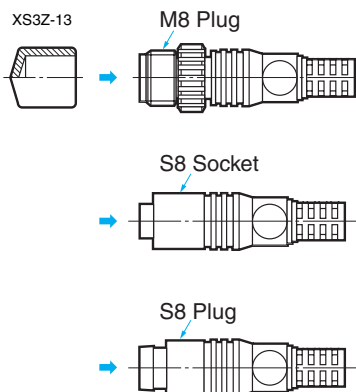

#### XS3Z-15

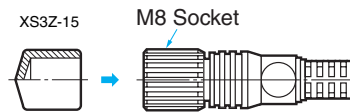

The Dust Cover is for dust prevention and does not ensure IP67. When mounting the Dust Cover to a Connector, be sure to press the Dust Cover onto the Connector until the Connector is fully inserted into the Dust Cover.

Model	Material	Suitable connector	
		Model	Mounting portion
XS3Z-13	Acrylic resin/transparent	XS3H/XS3M	M8 plug
		XS3F	S8 socket
		XS3H	S8 plug
XS3Z-15		XS3F	M8 socket

# XS3R Y-Joint Plug/Socket Connectors

● Screw-on Models (M8)

With Standard Cable:  
Without Cable:

XS3R-M426-1□□□-A  
XS3R-M426-□

## Dimensions

(Unit: mm)

XS3R-M426-1□□□-A

Connectors on Both Cable Ends (Y-Joint Plug/Socket)

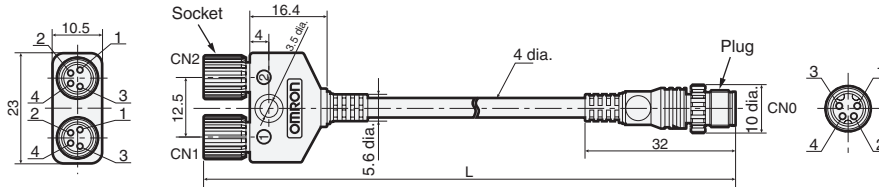

XS3R-M426-1□□□0-A

Connector on One Cable End (Y-Joint/Socket)

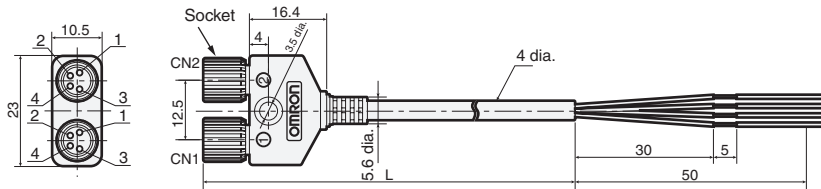

XS3R-M426-□

Connector on Both Ends (Y-Joint Plug/Socket) without Cable

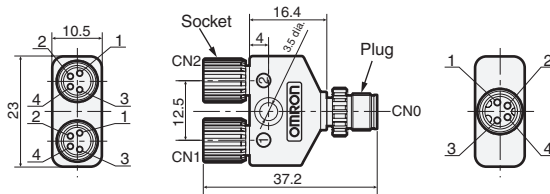

## Wiring Diagram

XS3R-M426-1□□□-A

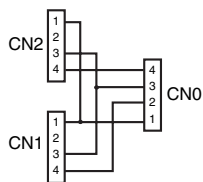

XS3R-M426-1□□□0-A

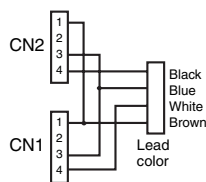

XS3R-M426-1

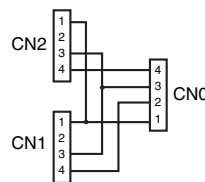

XS3R-M426-5

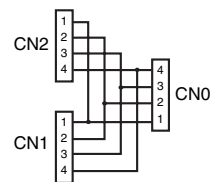

## Mating Connectors

Item	Model
XS3R(M8)	XS3F(M8)
	XS3H(M8)
	XS3W(M8)
	XS3P(M8)

## Ordering Information

For M8 Connectors

Cable	Connector	Cable length L (m)	Model	Minimum order
With cable	Connectors on both cable ends	0.5	XS3R-M426-1C51-A	5
		1	XS3R-M426-1011-A	
		2	XS3R-M426-1021-A	
		3	XS3R-M426-1031-A	
	Connector on one cable end	2	XS3R-M426-1020-A	
Without cable	Connectors on both cable ends	5	XS3R-M426-1050-A	10
		---	XS3R-M426-1 XS3R-M426-5	

## Safety Precautions

### Precautions for Correct Use

Do not use the product in atmospheres or environments that exceed product ratings.

#### Connections

- The XS3 and XS2 Sensor I/O Connectors cannot be connected to each other.
- When using Sensors with Connectors or Limit Switches, use the Sensor I/O Connectors specified in the catalog.
- Do not connect M8 screw models and S8 snap-in models together, otherwise the proper degree of protection of the Connectors will not be maintained.

#### Connector Connection and Disconnection

- Before connecting or disconnecting Connectors, make sure that no power is being supplied to the Connectors.
- When connecting or disconnecting Connectors, be sure to hold the Connectors by hand. Do not disconnect the Connectors by pulling the cable.
- Do not touch the engagement side of any Connector with wet hands. If there is any water on the Connector or near the Connector, be sure to wipe off the water before connecting or disconnecting the Connector, otherwise the Connector may short-circuit internally or not ensure good insulation.
- Make sure that engagement side of any Connector is free of metal dust or power.
- Do not use pliers to tighten mounting the thread bracket, otherwise the thread bracket may be damaged. Be sure to tighten each thread bracket by hand within a torque of 0.2 N·m. If the thread bracket is not tightened securely, the Connector may not maintain its proper degree of protection or the thread bracket may fall off due to vibration.
- Fully insert S8 snap-in models until the Connectors are hidden by the metal casing of the opposite parts, otherwise the Connectors will not maintain their proper degree of protection or the thread brackets may become loose due to vibration.

#### Cable Wire Color

- The M8/S8 Sensor I/O Connectors use the following lead wire colors.

Model		Pin No.			
		1	2	3	4
For DC	8-mm-dia. DC4	Brown	White	Blue	Black

#### Degree of Protection

- Do not impose external force continuously on the joints of pin blocks and covers, otherwise the Connectors may not keep its proper degree of protection (i.e., IP67).
- Connectors are not fully watertight. Do not use them underwater.
- The Connectors are not oil-resistant. Do not use them where they would be subject to oil.
- If Connectors are used in places with vibration or shock, secure the engaged side of each Connector, otherwise the Connectors may be disconnected or fail to maintain their proper degree of protection.
- Connectors are of resin mold construction. Do not impose excessive force on them.

#### Storage

Do not store Connectors for long periods of time in the following locations

- Locations subject to dust or high humidity
- Locations subject to ammonia gas or sulfide gas

#### Installation

- Do not make any cable bends near the base of the Unit.
- Any bends made must have a minimum radius of 36 mm.

## Read and Understand This Catalog

Please read and understand this catalog before purchasing the products. Please consult your OMRON representative if you have any questions or comments.

## Warranty and Limitations of Liability

### WARRANTY

OMRON's exclusive warranty is that the products are free from defects in materials and workmanship for a period of one year (or other period if specified) from date of sale by OMRON.

OMRON MAKES NO WARRANTY OR REPRESENTATION, EXPRESS OR IMPLIED, REGARDING NON-INFRINGEMENT, MERCHANTABILITY, OR FITNESS FOR PARTICULAR PURPOSE OF THE PRODUCTS. ANY BUYER OR USER ACKNOWLEDGES THAT THE BUYER OR USER ALONE HAS DETERMINED THAT THE PRODUCTS WILL SUITABLY MEET THE REQUIREMENTS OF THEIR INTENDED USE. OMRON DISCLAIMS ALL OTHER WARRANTIES, EXPRESS OR IMPLIED.

### LIMITATIONS OF LIABILITY

OMRON SHALL NOT BE RESPONSIBLE FOR SPECIAL, INDIRECT, OR CONSEQUENTIAL DAMAGES, LOSS OF PROFITS OR COMMERCIAL LOSS IN ANY WAY CONNECTED WITH THE PRODUCTS, WHETHER SUCH CLAIM IS BASED ON CONTRACT, WARRANTY, NEGLIGENCE, OR STRICT LIABILITY.

In no event shall the responsibility of OMRON for any act exceed the individual price of the product on which liability is asserted.

IN NO EVENT SHALL OMRON BE RESPONSIBLE FOR WARRANTY, REPAIR, OR OTHER CLAIMS REGARDING THE PRODUCTS UNLESS OMRON'S ANALYSIS CONFIRMS THAT THE PRODUCTS WERE PROPERLY HANDLED, STORED, INSTALLED, AND MAINTAINED AND NOT SUBJECT TO CONTAMINATION, ABUSE, MISUSE, OR INAPPROPRIATE MODIFICATION OR REPAIR.

## Application Considerations

### SUITABILITY FOR USE

OMRON shall not be responsible for conformity with any standards, codes, or regulations that apply to the combination of products in the customer's application or use of the products.

At the customer's request, OMRON will provide applicable third party certification documents identifying ratings and limitations of use that apply to the products. This information by itself is not sufficient for a complete determination of the suitability of the products in combination with the end product, machine, system, or other application or use.

The following are some examples of applications for which particular attention must be given. This is not intended to be an exhaustive list of all possible uses of the products, nor is it intended to imply that the uses listed may be suitable for the products:

- Outdoor use, uses involving potential chemical contamination or electrical interference, or conditions or uses not described in this catalog.
- Nuclear energy control systems, combustion systems, railroad systems, aviation systems, medical equipment, amusement machines, vehicles, safety equipment, and installations subject to separate industry or government regulations.
- Systems, machines, and equipment that could present a risk to life or property.

Please know and observe all prohibitions of use applicable to the products.

NEVER USE THE PRODUCTS FOR AN APPLICATION INVOLVING SERIOUS RISK TO LIFE OR PROPERTY WITHOUT ENSURING THAT THE SYSTEM AS A WHOLE HAS BEEN DESIGNED TO ADDRESS THE RISKS, AND THAT THE OMRON PRODUCTS ARE PROPERLY RATED AND INSTALLED FOR THE INTENDED USE WITHIN THE OVERALL EQUIPMENT OR SYSTEM.

### PROGRAMMABLE PRODUCTS

OMRON shall not be responsible for the user's programming of a programmable product, or any consequence thereof.

## Disclaimers

### CHANGE IN SPECIFICATIONS

Product specifications and accessories may be changed at any time based on improvements and other reasons.

It is our practice to change model numbers when published ratings or features are changed, or when significant construction changes are made. However, some specifications of the products may be changed without any notice. When in doubt, special model numbers may be assigned to fix or establish key specifications for your application on your request. Please consult with your OMRON representative at any time to confirm actual specifications of purchased products.

### DIMENSIONS AND WEIGHTS

Dimensions and weights are nominal and are not to be used for manufacturing purposes, even when tolerances are shown.

### PERFORMANCE DATA

Performance data given in this catalog is provided as a guide for the user in determining suitability and does not constitute a warranty. It may represent the result of OMRON's test conditions, and the users must correlate it to actual application requirements. Actual performance is subject to the OMRON Warranty and Limitations of Liability.

### ERRORS AND OMISSIONS

The information in this document has been carefully checked and is believed to be accurate; however, no responsibility is assumed for clerical, typographical, or proofreading errors, or omissions.

2011.11

In the interest of product improvement, specifications are subject to change without notice.

**OMRON Corporation**  
Industrial Automation Company

<http://www.ia.omron.com/>

(c)Copyright OMRON Corporation 2011 All Right Reserved.

# Mouser Electronics

Authorized Distributor

Click to View Pricing, Inventory, Delivery & Lifecycle Information:

## Omron:

[XS3F-M421-410-R](#) [XS3F-E421-402-A](#) [XS3F-E421-405-A](#) [XS3F-E421-410-A](#) [XS3F-E422-402-A](#) [XS3F-E422-405-A](#)  
[XS3F-E422-410-A](#) [XS3P-M421-2](#) [XS3W-M421-401-R](#) [XS3W-M421-402-R](#) [XS3P-M421-1](#) [XS3F-M422-410-A](#) [XS3H-M421-401-R](#)