

**SERIES:** VSK-S10-T | **DESCRIPTION:** AC-DC POWER SUPPLY

**FEATURES**

- up to 10 W continuous output
- encapsulated compact case
- universal input (85~264 Vac)
- single regulated output from 3.3~24 Vdc
- over voltage, short circuit, and short circuit protection
- CE, UL safety approval
- efficiency up to 83%



| MODEL           | output voltage | output current | output power | ripple and noise <sup>1</sup> | efficiency |
|-----------------|----------------|----------------|--------------|-------------------------------|------------|
|                 | (Vdc)          | max (A)        | max (W)      | max (mVp-p)                   | max (%)    |
| VSK-S10-3R3UA-T | 3.3            | 2              | 6.6          | 100                           | 72         |
| VSK-S10-5UA-T   | 5              | 2              | 10           | 100                           | 76         |
| VSK-S10-9UA-T   | 9              | 1.1            | 10           | 100                           | 80         |
| VSK-S10-12UA-T  | 12             | 0.9            | 10           | 100                           | 81         |
| VSK-S10-15UA-T  | 15             | 0.7            | 10           | 100                           | 82         |
| VSK-S10-24UA-T  | 24             | 0.45           | 10           | 100                           | 83         |

Notes: 1. Ripple and noise are measured at 20 MHz BW by "parallel cable" method with 1 µF ceramic and 10 µF electrolytic capacitors on the output.

**PART NUMBER KEY**

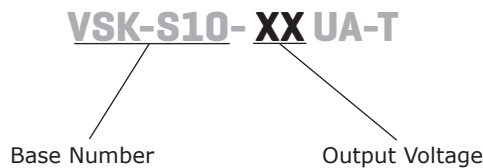

**INPUT**

| parameter                 | conditions/description                         | min | typ   | max | units |
|---------------------------|--|-----|-------|-----|-------|
| voltage                   |  | 85  |       | 264 | Vac   |
|                           |  | 100 |       | 370 | Vdc   |
| frequency                 |  | 47  |       | 440 | Hz    |
| current                   | at 110 Vac                                     |     | 230   |     | mA    |
|                           | at 230 Vac                                     |     | 150   |     | mA    |
| inrush current            | at 110 Vac                                     |     | 10    |     | A     |
|                           | at 230 Vac                                     |     | 20    |     | A     |
| input fuse                | recommended external 2 A/250 V, slow-blow type |     |       |     |       |
| temperature coefficient   |  |     | ±0.02 |     | %/°C  |
| no load power consumption |  |     | 0.5   |     | W     |

**OUTPUT**

| parameter            | conditions/description | min | typ  | max    | units |
|----------------------|------------------------|-----|------|--------|-------|
| capcitive load       | 3.3 Vdc model          |     |      | 15,000 | µF    |
|                      | 5 Vdc model            |     |      | 12,000 | µF    |
|                      | 9 Vdc model            |     |      | 6000   | µF    |
|                      | 12 Vdc model           |     |      | 2000   | µF    |
|                      | 15 Vdc model           |     |      | 1500   | µF    |
|                      | 24 Vdc model           |     |      | 500    | µF    |
| line regulation      | full load              |     | ±0.5 |        | %     |
| load regulation      | at 10~100% load        |     | ±1   |        | %     |
| voltage set accuracy | 3.3 Vdc model          |     | ±3   |        | %     |
|                      | all other models       |     | ±2   |        | %     |
| hold-up time         | at 230 Vac             |     | 80   |        | ms    |
| switching frequency  |                        |     | 65   |        | kHz   |

**PROTECTIONS**

| parameter                | conditions/description | min | typ | max | units |
|--------------------------|------------------------|-----|-----|-----|-------|
| over voltage protection  | 3.3, 5 Vdc models      |     |     | 7.5 | Vdc   |
|                          | 9 Vdc model            |     |     | 15  | Vdc   |
|                          | 12, 15 Vdc models      |     |     | 20  | Vdc   |
|                          | 24 Vdc model           |     |     | 30  | Vdc   |
| over current protection  |                        | 110 |     |     | %     |
| short circuit protection | auto recovery          |     |     |     |       |

**SAFETY & COMPLIANCE**

| parameter           | conditions/description   | min   | typ | max | units |
|---------------------|--|-------|-----|-----|-------|
| isolation voltage   | input to output  | 4,000 |     |     | Vac   |
| safety approvals    | UL60950-1  |       |     |     |       |
| safety class        | Class II   |       |     |     |       |
| conducted emissions | CISPR11/EN55011, Class A, CISPR11/EN55011, Class B (external circuit required, see figure 2) |       |     |     |       |
| radiated emissions  | CISPR11/EN55011, Class A, CISPR11/EN55011, Class B (external circuit required, see figure 2) |       |     |     |       |
| ESD                 | IEC/EN61000-4-2 Class B, contact ±6 kV/air ±8kV  |       |     |     |       |
| radiated immunity   | IEC/EN61000-4-3 Class A, 10V/m   |       |     |     |       |
| EFT/burst           | IEC/EN61000-4-4 Class B, ±2 kV   |       |     |     |       |
|                     | IEC/EN61000-4-4 Class B, ±4 kV (external circuit required, see figure 2)                     |       |     |     |       |
| surge               | IEC/EN61000-4-5 Class B, ±1 kV (external circuit required, see figure 1)                     |       |     |     |       |
|                     | IEC/EN61000-4-5 Class B, ±2 kV / ±4 kV (external circuit required, see figure 2)             |       |     |     |       |
| conducted immunity  | IEC/EN61000-4-6 Class A, 10 Vr.m.s   |       |     |     |       |

## SAFETY & COMPLIANCE (CONTINUED)

| parameter                    | conditions/description           | min     | typ | max | units |
|------------------------------|----------------------------------|---------|-----|-----|-------|
| PFM                          | IEC/EN61000-4-8 Class A, 10 A/m  |         |     |     |       |
| voltage dips & interruptions | IEC/EN61000-4-11 Class B, 0%-70% |         |     |     |       |
| MTBF                         | as per MIL-HDBK-217F, at 25°C    | 300,000 |     |     | hours |
| RoHS                         | 2011/65/EU                       |         |     |     |       |

## ENVIRONMENTAL

| parameter             | conditions/description | min | typ | max | units |
|-----------------------|------------------------|-----|-----|-----|-------|
| operating temperature | see derating curves    | -25 |     | 70  | °C    |
| storage temperature   |                        | -25 |     | 105 | °C    |
| storage humidity      |                        |     |     | 95  | %     |

## DERATING CURVES

load vs. ambient temperature

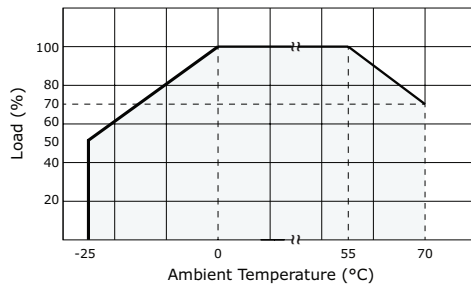

load vs. input voltage (Vac)

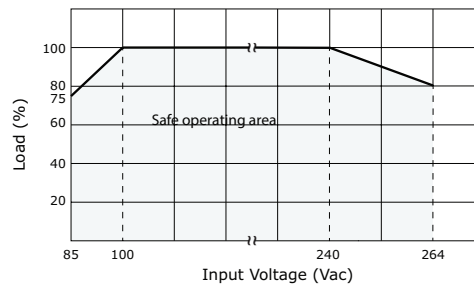

load vs. input voltage (Vdc)

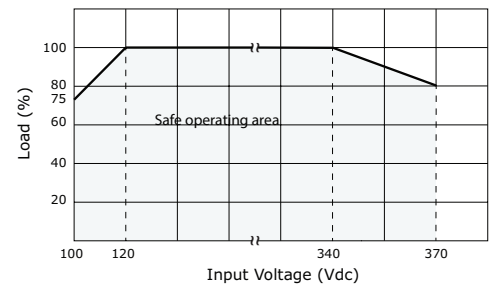

## MECHANICAL

| parameter  | conditions/description                           | min | typ | max | units |
|------------|--|-----|-----|-----|-------|
| dimensions | 76 x 31.50 x 27.80 (2.992 x 1.240 x 1.0944 inch) |     |     |     | mm    |
| material   | UL94V-0  |     |     |     |       |
| weight     |  |     | 70  |     | g     |

## MECHANICAL DRAWING

units: mm [inch]  
tolerance: ±0.50 [±0.020]

wire range: 24~12 AWG

| PIN CONNECTIONS |          |
|-----------------|----------|
| PIN             | FUNCTION |
| 1               | AC(N)    |
| 2               | AC(L)    |
| 3               | +Vo      |
| 4               | -Vo      |

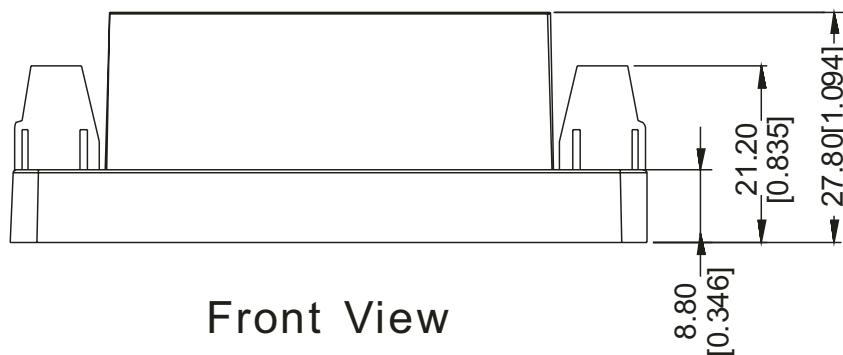
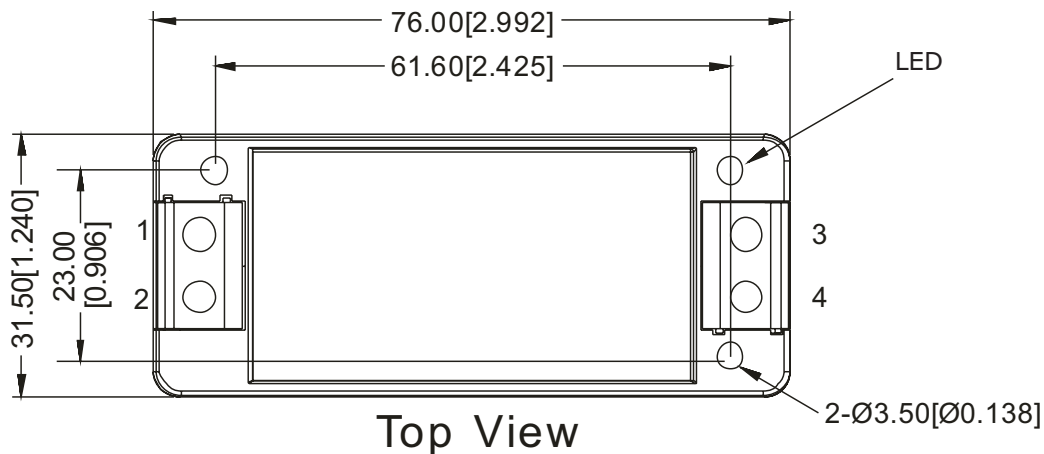

## TYPICAL APPLICATION CIRCUIT

Figure 1



Table 1

| Recommended External Circuit Components |                 |                 |          |         |         |        |
|---|-----------------|-----------------|----------|---------|---------|--------|
| MODEL                                   | C1 <sup>1</sup> | C2 <sup>1</sup> | TVS      | FUSE    | MOV     | NTC    |
| VSK-S10-3R3UA-T                         | 1 $\mu$ F/50V   | 220 $\mu$ F/10V | SMBJ7.0A | 2A/250V | S14K300 | 10D-10 |
| VSK-S10-5UA-T                           | 1 $\mu$ F/50V   | 220 $\mu$ F/10V | SMBJ7.0A | 2A/250V | S14K300 | 10D-10 |
| VSK-S10-9UA-T                           | 1 $\mu$ F/50V   | 120 $\mu$ F/25V | SMBJ12A  | 2A/250V | S14K300 | 10D-10 |
| VSK-S10-12UA-T                          | 1 $\mu$ F/50V   | 120 $\mu$ F/25V | SMBJ20A  | 2A/250V | S14K300 | 10D-10 |
| VSK-S10-15UA-T                          | 1 $\mu$ F/50V   | 120 $\mu$ F/25V | SMBJ20A  | 2A/250V | S14K300 | 10D-10 |
| VSK-S10-24UA-T                          | 1 $\mu$ F/50V   | 68 $\mu$ F/35V  | SMBJ30A  | 2A/250V | S14K300 | 10D-10 |

Note: 1. Output filtering capacitor C1 is a ceramic capacitor that is used to filter high frequency noise. C2 is an electrolytic capacitor. It is recommended to use high frequency and low impedance electrolytic capacitors. For capacitance and current of capacitor please refer to the manufacturer's datasheet. Voltage derating of capacitor should be 80% or above.

## EMC RECOMMENDED CIRCUIT

Figure 2

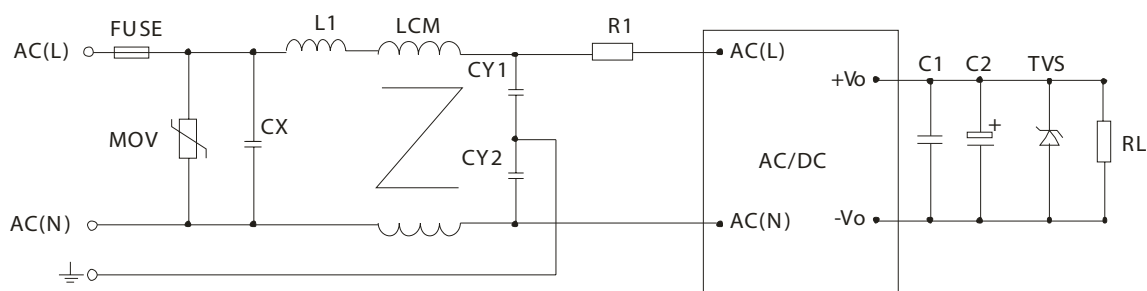

Table 2

| Recommended External Circuit Components |         |            |                    |       |                  |                 |             |             |
|---|---------|------------|--------------------|-------|------------------|-----------------|-------------|-------------|
| FUSE                                    | MOV     | CY1, CY2   | CX                 | LCM   | L1               | R1              | C1, C2,     | TVS         |
| 2A/250 Vdc slow fusing                  | S14K300 | 1nF/400VAC | 0.1 $\mu$ F/275VAC | 2.2mH | 4.7 $\mu$ H/2.0A | 12 $\Omega$ /3W | see Table 1 | see Table 1 |

Note: 1. All specifications measured at Ta=25°C, humidity <75%, nominal Vac input voltage, and rated output load, unless otherwise specified.

## REVISION HISTORY

---

| rev. | description                                  | date       |
|------|--|------------|
| 1.0  | initial release                              | 09/06/2012 |
| 1.01 | updated mechanical drawing and product photo | 11/28/2012 |
| 1.02 | updated spec                                 | 03/08/2013 |
| 1.03 | changed internal IC, updated datasheet       | 06/08/2015 |

The revision history provided is for informational purposes only and is believed to be accurate.



**CUI INC**<sup>®</sup>

**Headquarters**  
20050 SW 112th Ave.  
Tualatin, OR 97062  
**800.275.4899**

Fax 503.612.2383  
**cui.com**  
techsupport@cui.com

CUI offers a two (2) year limited warranty. Complete warranty information is listed on our website.

CUI reserves the right to make changes to the product at any time without notice. Information provided by CUI is believed to be accurate and reliable. However, no responsibility is assumed by CUI for its use, nor for any infringements of patents or other rights of third parties which may result from its use.

CUI products are not authorized or warranted for use as critical components in equipment that requires an extremely high level of reliability. A critical component is any component of a life support device or system whose failure to perform can be reasonably expected to cause the failure of the life support device or system, or to affect its safety or effectiveness.