

BDW42G (NPN), BDW46G, BDW47G (PNP)

Darlington Complementary Silicon Power Transistors

This series of plastic, medium-power silicon NPN and PNP Darlington transistors are designed for general purpose and low speed switching applications.

Features

- High DC Current Gain – $h_{FE} = 2500$ (typ) @ $I_C = 5.0$ Adc.
- Collector Emitter Sustaining Voltage @ 30 mAdc:
 $V_{CE(sus)} = 80$ Vdc (min) – BDW46
 100 Vdc (min) – BDW42/BDW47
- Low Collector Emitter Saturation Voltage
 $V_{CE(sat)} = 2.0$ Vdc (max) @ $I_C = 5.0$ Adc
 3.0 Vdc (max) @ $I_C = 10.0$ Adc
- Monolithic Construction with Built-In Base Emitter Shunt resistors
- TO-220 Compact Package
- These Devices are Pb-Free and are RoHS Compliant*

MAXIMUM RATINGS

Rating	Symbol	Value	Unit
Collector-Emitter Voltage BDW46 BDW42, BDW47	V_{CEO}	80 100	Vdc
Collector-Base Voltage BDW46 BDW42, BDW47	V_{CB}	80 100	Vdc
Emitter-Base Voltage	V_{EB}	5.0	Vdc
Collector Current	I_C	15	Adc
Base Current	I_B	0.5	Adc
Total Device Dissipation @ $T_C = 25^\circ\text{C}$ Derate above 25°C	P_D	85 0.68	W W/ $^\circ\text{C}$
Operating and Storage Junction Temperature Range	T_J, T_{stg}	-55 to +150	$^\circ\text{C}$

Stresses exceeding those listed in the Maximum Ratings table may damage the device. If any of these limits are exceeded, device functionality should not be assumed, damage may occur and reliability may be affected.

THERMAL CHARACTERISTICS

Characteristic	Symbol	Max	Unit
Thermal Resistance, Junction-to-Case	$R_{\theta JC}$	1.47	$^\circ\text{C/W}$

*For additional information on our Pb-Free strategy and soldering details, please download the ON Semiconductor Soldering and Mounting Techniques Reference Manual, SOLDERRM/D.



ON Semiconductor®

www.onsemi.com

15 AMP DARLINGTON COMPLEMENTARY SILICON POWER TRANSISTORS 80-100 VOLT, 85 WATT

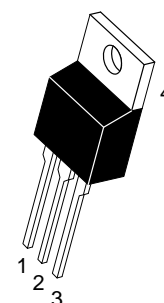

TO-220
CASE 221A
STYLE 1

MARKING DIAGRAM

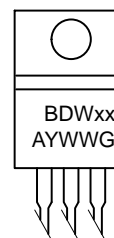

BDWxx = Device Code
x = 42, 46, or 47
A = Assembly Location
Y = Year
WW = Work Week
G = Pb-Free Package

ORDERING INFORMATION

Device	Package	Shipping
BDW42G	TO-220 (Pb-Free)	50 Units/Rail
BDW46G	TO-220 (Pb-Free)	50 Units/Rail
BDW47G	TO-220 (Pb-Free)	50 Units/Rail

BDW42G (NPN), BDW46G, BDW47G (PNP)

ELECTRICAL CHARACTERISTICS ($T_C = 25^\circ\text{C}$ unless otherwise noted)

Characteristic	Symbol	Min	Max	Unit
----------------	--------	-----	-----	------

OFF CHARACTERISTICS

Collector Emitter Sustaining Voltage (Note 1) ($I_C = 30 \text{ mAdc}$, $I_B = 0$)	BDW46 BDW42/BDW47	$V_{CEO(sus)}$	80 100	– –	Vdc
Collector Cutoff Current ($V_{CE} = 40 \text{ Vdc}$, $I_B = 0$) ($V_{CE} = 50 \text{ Vdc}$, $I_B = 0$)	BDW46 BDW42/BDW47	I_{CEO}	– –	2.0 2.0	mAdc
Collector Cutoff Current ($V_{CB} = 80 \text{ Vdc}$, $I_E = 0$) ($V_{CB} = 100 \text{ Vdc}$, $I_E = 0$)	BDW46 BDW42/BDW47	I_{CBO}	– –	1.0 1.0	mAdc
Emitter Cutoff Current ($V_{BE} = 5.0 \text{ Vdc}$, $I_C = 0$)		I_{EBO}	–	2.0	mAdc

ON CHARACTERISTICS (Note 1)

DC Current Gain ($I_C = 5.0 \text{ Adc}$, $V_{CE} = 4.0 \text{ Vdc}$) ($I_C = 10 \text{ Adc}$, $V_{CE} = 4.0 \text{ Vdc}$)	h_{FE}	1000 250	– –	
Collector–Emitter Saturation Voltage ($I_C = 5.0 \text{ Adc}$, $I_B = 10 \text{ mAdc}$) ($I_C = 10 \text{ Adc}$, $I_B = 50 \text{ mAdc}$)	$V_{CE(sat)}$	– –	2.0 3.0	Vdc
Base–Emitter On Voltage ($I_C = 10 \text{ Adc}$, $V_{CE} = 4.0 \text{ Vdc}$)	$V_{BE(on)}$	–	3.0	Vdc

SECOND BREAKDOWN (Note 2)

Second Breakdown Collector Current with Base Forward Biased	$I_{S/b}$			Adc
BDW42	$V_{CE} = 28.4 \text{ Vdc}$	3.0	–	
	$V_{CE} = 40 \text{ Vdc}$	1.2	–	
BDW46/BDW47	$V_{CE} = 22.5 \text{ Vdc}$	3.8	–	
	$V_{CE} = 36 \text{ Vdc}$	1.2	–	

DYNAMIC CHARACTERISTICS

Magnitude of common emitter small signal short circuit current transfer ratio ($I_C = 3.0 \text{ Adc}$, $V_{CE} = 3.0 \text{ Vdc}$, $f = 1.0 \text{ MHz}$)	f_T	4.0	–	MHz
Output Capacitance ($V_{CB} = 10 \text{ Vdc}$, $I_E = 0$, $f = 0.1 \text{ MHz}$)	C_{ob}	– –	200 300	pF
Small–Signal Current Gain ($I_C = 3.0 \text{ Adc}$, $V_{CE} = 3.0 \text{ Vdc}$, $f = 1.0 \text{ kHz}$)	h_{fe}	300	–	

Product parametric performance is indicated in the Electrical Characteristics for the listed test conditions, unless otherwise noted. Product performance may not be indicated by the Electrical Characteristics if operated under different conditions.

1. Pulse Test: Pulse Width = 300 μs , Duty Cycle = 2.0%.
2. Pulse Test non repetitive: Pulse Width = 250 ms.

BDW42G (NPN), BDW46G, BDW47G (PNP)

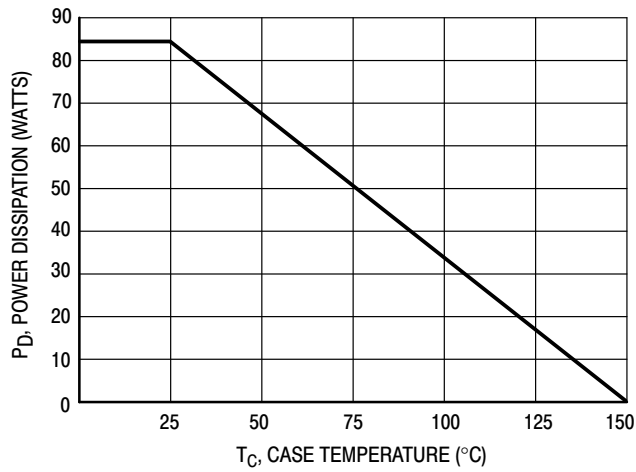

Figure 1. Power Temperature Derating Curve

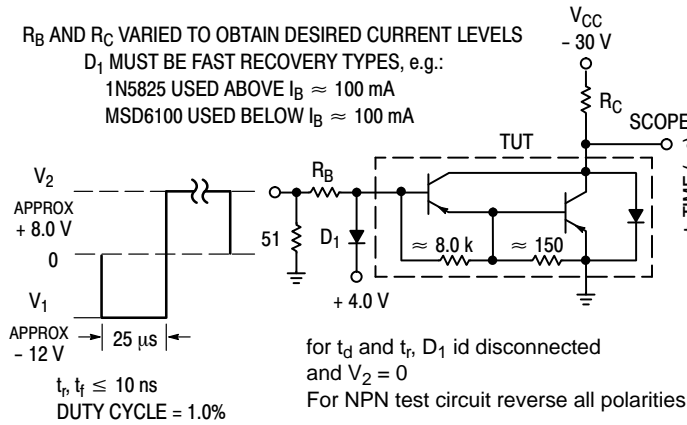

Figure 2. Switching Times Test Circuit

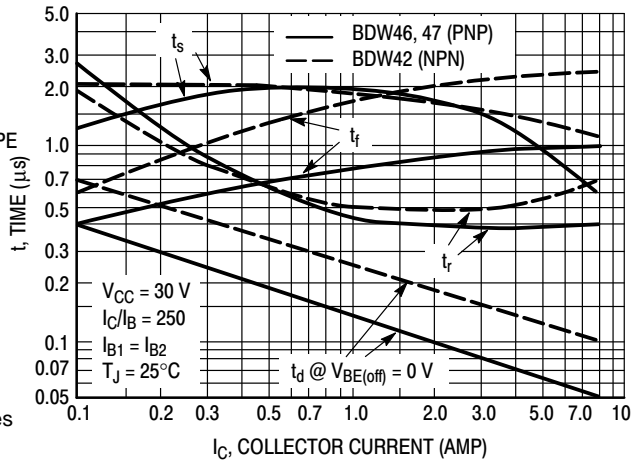

Figure 3. Switching Times

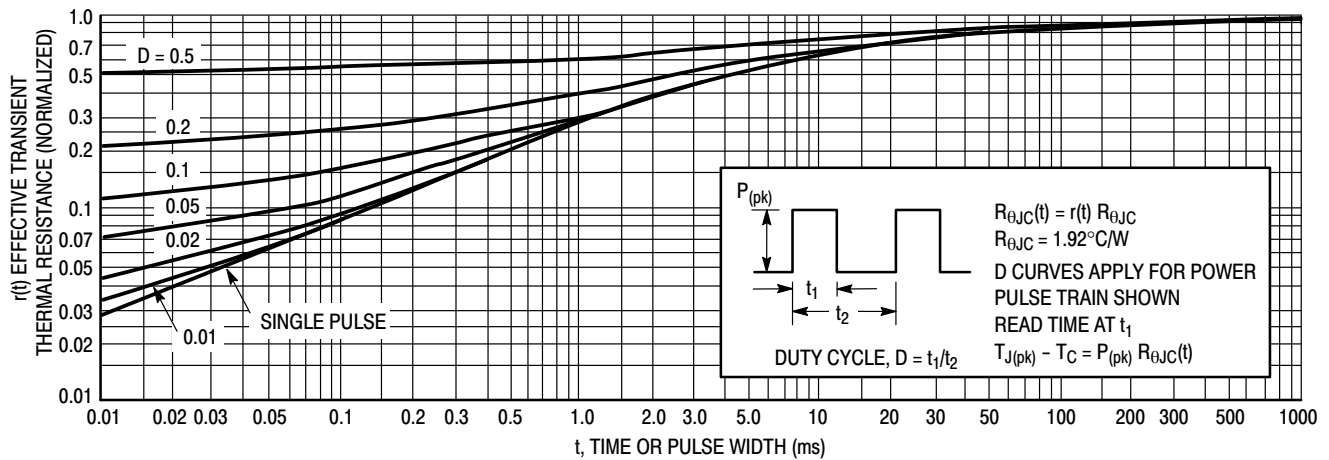

Figure 4. Thermal Response

BDW42G (NPN), BDW46G, BDW47G (PNP)

ACTIVE-REGION SAFE OPERATING AREA

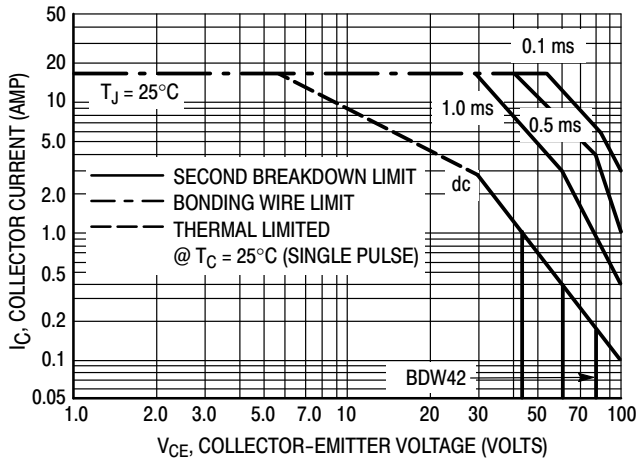

Figure 5. BDW42



Figure 6. BDW46 and BDW47

There are two limitations on the power handling ability of a transistor: average junction temperature and second breakdown. Safe operating area curves indicate $I_C - V_{CE}$ limits of the transistor that must be observed for reliable operation; i.e., the transistor must not be subjected to greater dissipation than the curves indicate. The data of Figure 5 and 6 is based on $T_{J(pk)} = 200^\circ\text{C}$; T_C is variable depending on conditions.

Second breakdown pulse limits are valid for duty cycles to 10% provided $T_{J(pk)} \leq 200^\circ\text{C}$. $T_{J(pk)}$ may be calculated from the data in Figure 4. At high case temperatures, thermal limitations will reduce the power that can be handled to values less than the limitations imposed by second breakdown.

*Linear extrapolation

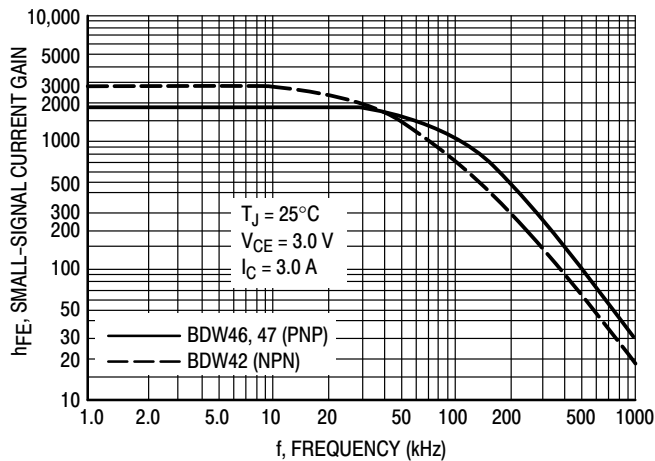

Figure 7. Small-Signal Current Gain

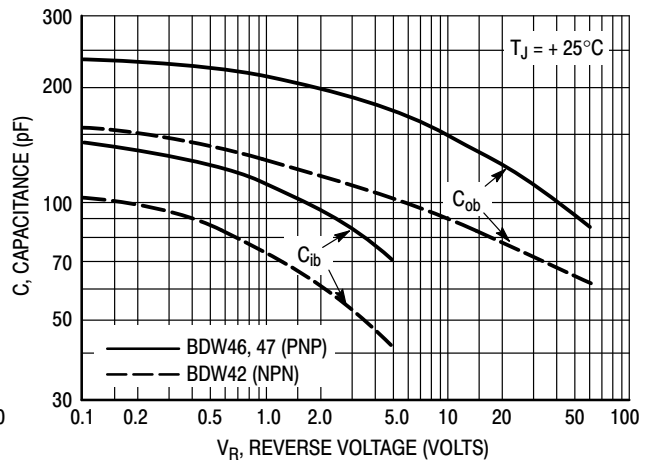

Figure 8. Capacitance

BDW42G (NPN), BDW46G, BDW47G (PNP)

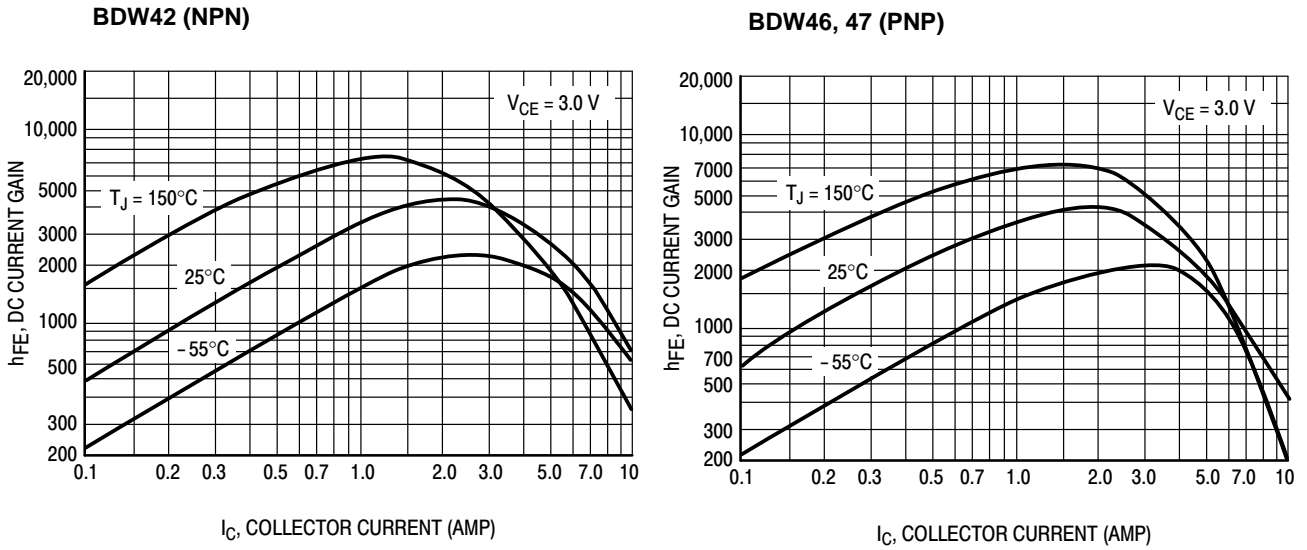

Figure 9. DC Current Gain

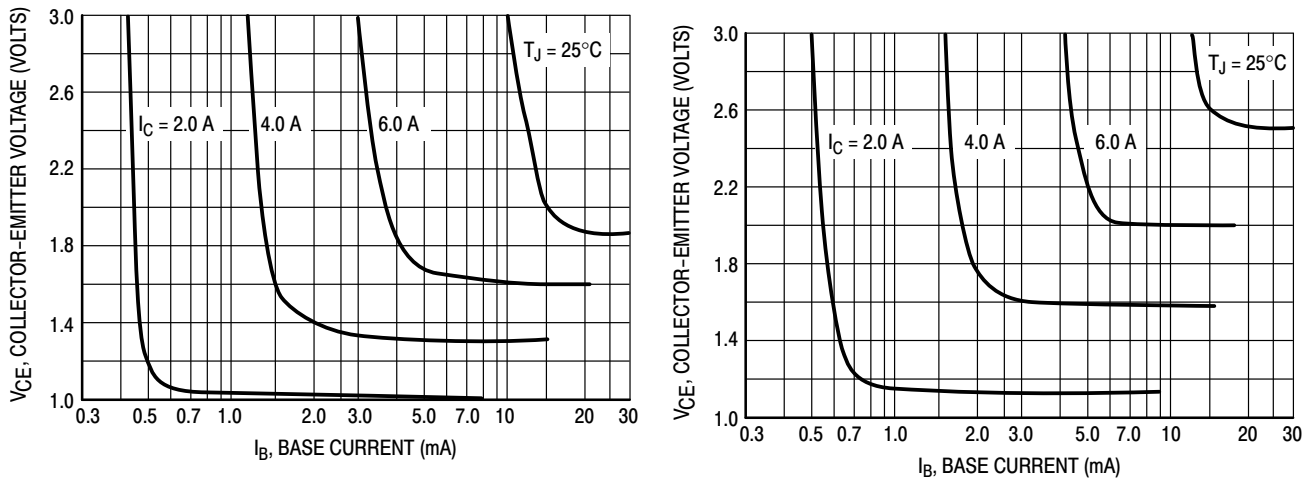

Figure 10. Collector Saturation Region

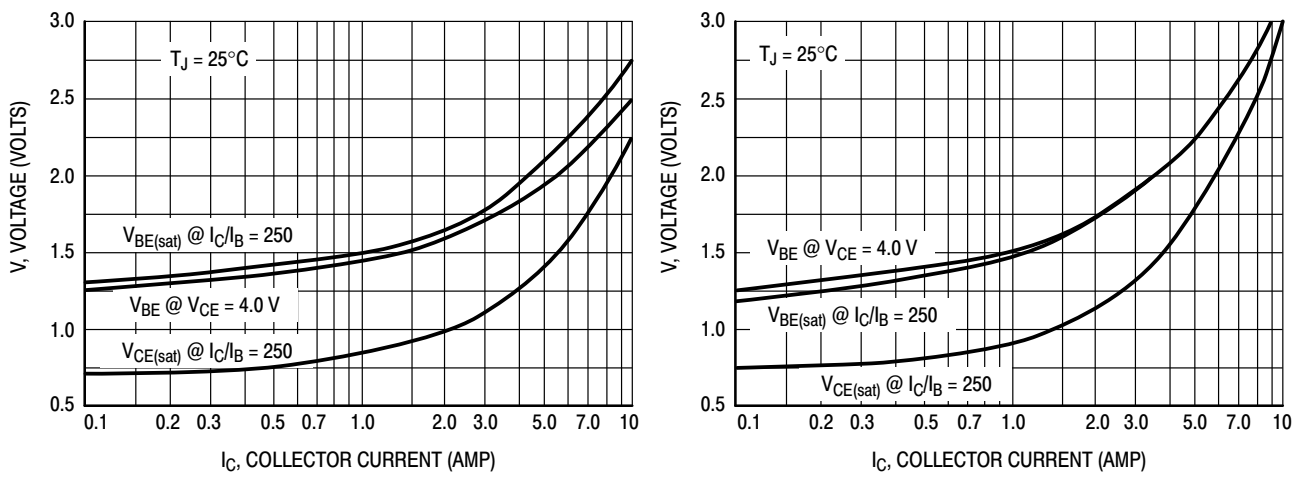
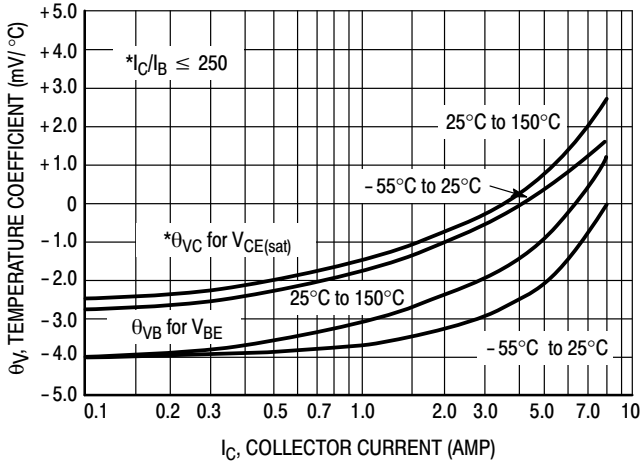

Figure 11. "On" Voltages

BDW42G (NPN), BDW46G, BDW47G (PNP)

BDW42 (NPN)



BDW46, 47 (PNP)

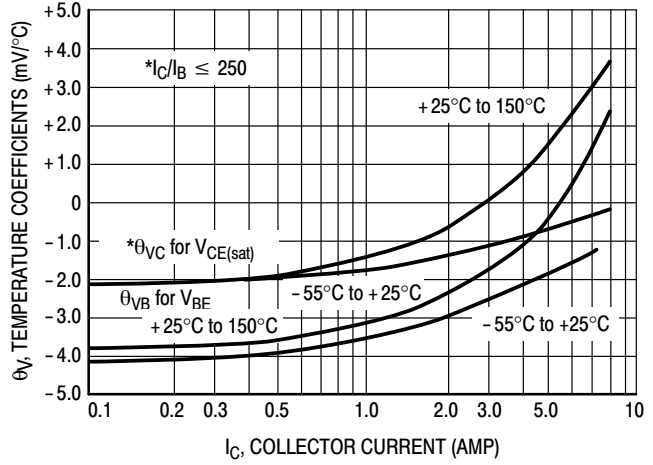

Figure 12. Temperature Coefficients

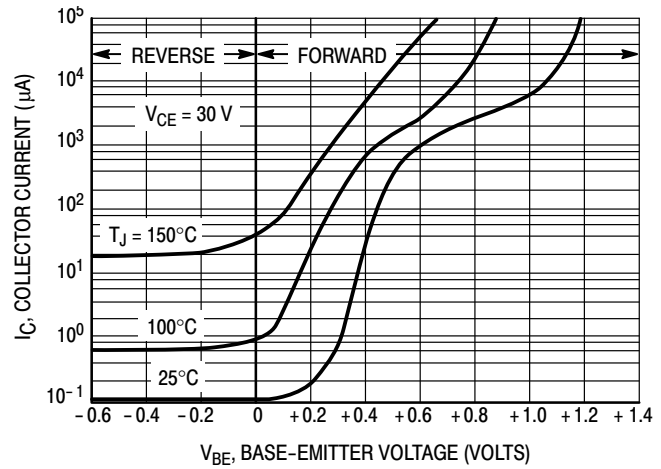
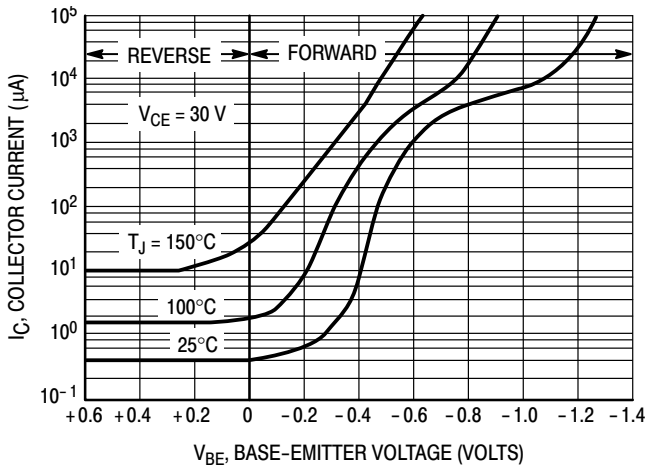

Figure 13. Collector Cut-Off Region

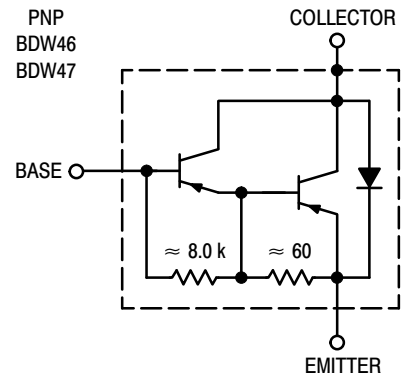
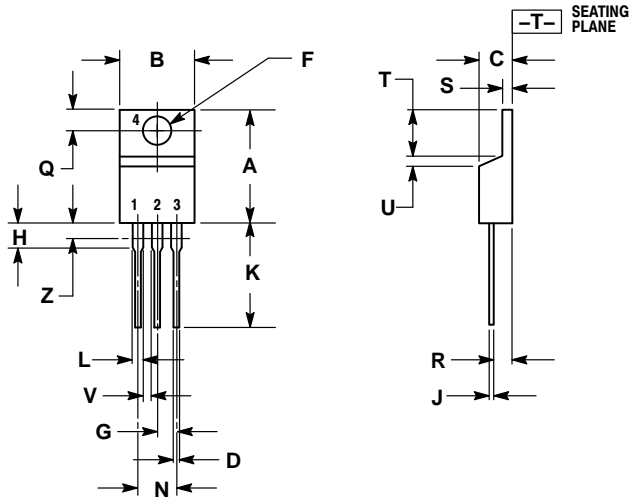

Figure 14. Darlington Schematic

BDW42G (NPN), BDW46G, BDW47G (PNP)

PACKAGE DIMENSIONS

TO-220
CASE 221A-09
ISSUE AH



NOTES:

1. DIMENSIONING AND TOLERANCING PER ANSI Y14.5M, 1982.
2. CONTROLLING DIMENSION: INCH.
3. DIMENSION Z DEFINES A ZONE WHERE ALL BODY AND LEAD IRREGULARITIES ARE ALLOWED.

DIM	INCHES		MILLIMETERS	
	MIN	MAX	MIN	MAX
A	0.570	0.620	14.48	15.75
B	0.380	0.415	9.66	10.53
C	0.160	0.190	4.07	4.83
D	0.025	0.038	0.64	0.96
F	0.142	0.161	3.61	4.09
G	0.095	0.105	2.42	2.66
H	0.110	0.161	2.80	4.10
J	0.014	0.024	0.36	0.61
K	0.500	0.562	12.70	14.27
L	0.045	0.060	1.15	1.52
N	0.190	0.210	4.83	5.33
Q	0.100	0.120	2.54	3.04
R	0.080	0.110	2.04	2.79
S	0.045	0.055	1.15	1.39
T	0.235	0.255	5.97	6.47
U	0.000	0.050	0.00	1.27
V	0.045	---	1.15	---
Z	---	0.080	---	2.04

STYLE 1:

- PIN 1. BASE
2. COLLECTOR
3. EMITTER
4. COLLECTOR

ON Semiconductor and are trademarks of Semiconductor Components Industries, LLC dba ON Semiconductor or its subsidiaries in the United States and/or other countries. ON Semiconductor owns the rights to a number of patents, trademarks, copyrights, trade secrets, and other intellectual property. A listing of ON Semiconductor's product/patent coverage may be accessed at www.onsemi.com/site/pdf/Patent-Marking.pdf. ON Semiconductor reserves the right to make changes without further notice to any products herein. ON Semiconductor makes no warranty, representation or guarantee regarding the suitability of its products for any particular purpose, nor does ON Semiconductor assume any liability arising out of the application or use of any product or circuit, and specifically disclaims any and all liability, including without limitation special, consequential or incidental damages. Buyer is responsible for its products and applications using ON Semiconductor products, including compliance with all laws, regulations and safety requirements or standards, regardless of any support or applications information provided by ON Semiconductor. "Typical" parameters which may be provided in ON Semiconductor data sheets and/or specifications can and do vary in different applications and actual performance may vary over time. All operating parameters, including "Typicals" must be validated for each customer application by customer's technical experts. ON Semiconductor does not convey any license under its patent rights nor the rights of others. ON Semiconductor products are not designed, intended, or authorized for use as a critical component in life support systems or any FDA Class 3 medical devices or medical devices with a same or similar classification in a foreign jurisdiction or any devices intended for implantation in the human body. Should Buyer purchase or use ON Semiconductor products for any such unintended or unauthorized application, Buyer shall indemnify and hold ON Semiconductor and its officers, employees, subsidiaries, affiliates, and distributors harmless against all claims, costs, damages, and expenses, and reasonable attorney fees arising out of, directly or indirectly, any claim of personal injury or death associated with such unintended or unauthorized use, even if such claim alleges that ON Semiconductor was negligent regarding the design or manufacture of the part. ON Semiconductor is an Equal Opportunity/Affirmative Action Employer. This literature is subject to all applicable copyright laws and is not for resale in any manner.

PUBLICATION ORDERING INFORMATION

LITERATURE FULFILLMENT:

Literature Distribution Center for ON Semiconductor
19521 E. 32nd Pkwy, Aurora, Colorado 80011 USA
Phone: 303-675-2175 or 800-344-3860 Toll Free USA/Canada
Fax: 303-675-2176 or 800-344-3867 Toll Free USA/Canada
Email: orderlit@onsemi.com

N. American Technical Support: 800-282-9855 Toll Free
USA/Canada
Europe, Middle East and Africa Technical Support:
Phone: 421 33 790 2910
Japan Customer Focus Center
Phone: 81-3-5817-1050

ON Semiconductor Website: www.onsemi.com
Order Literature: <http://www.onsemi.com/orderlit>

For additional information, please contact your local Sales Representative

Mouser Electronics

Authorized Distributor

Click to View Pricing, Inventory, Delivery & Lifecycle Information:

[ON Semiconductor:](#)

[BDW42G](#) [BDW46G](#) [BDW47G](#)