

RIGHT ANGLE

HOUSING: 41815-N-AN-*** (WITH RAMP)
HOUSING: 41815-N-DN-*** (WITHOUT RAMP)

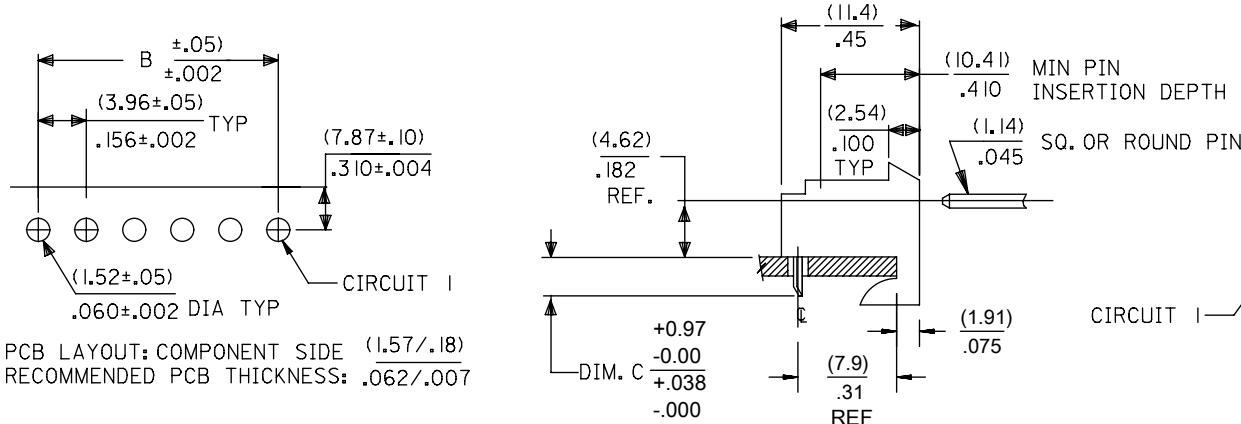

PCB LAYOUT: COMPONENT SIDE (1.57/.18)
RECOMMENDED PCB THICKNESS: .062/.007

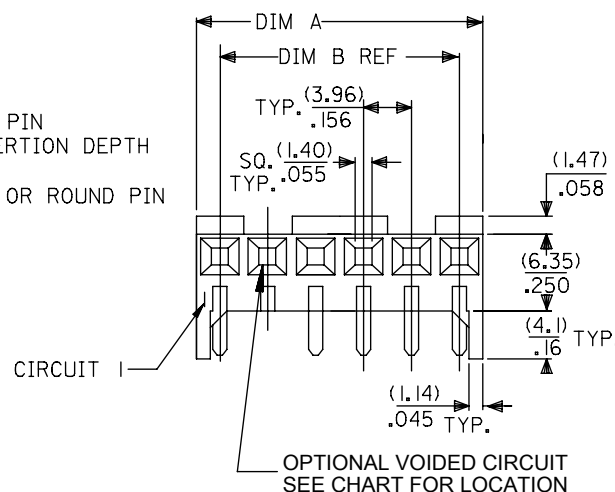

MIN PIN INSERTION DEPTH
SQ. OR ROUND PIN
OPTIONAL VOIDED CIRCUIT SEE CHART FOR LOCATION

BOTTOM ENTRY

HOUSING: 41815-N-AN-*** (WITH RAMP)
HOUSING: 41815-N-DN-*** (WITHOUT RAMP)

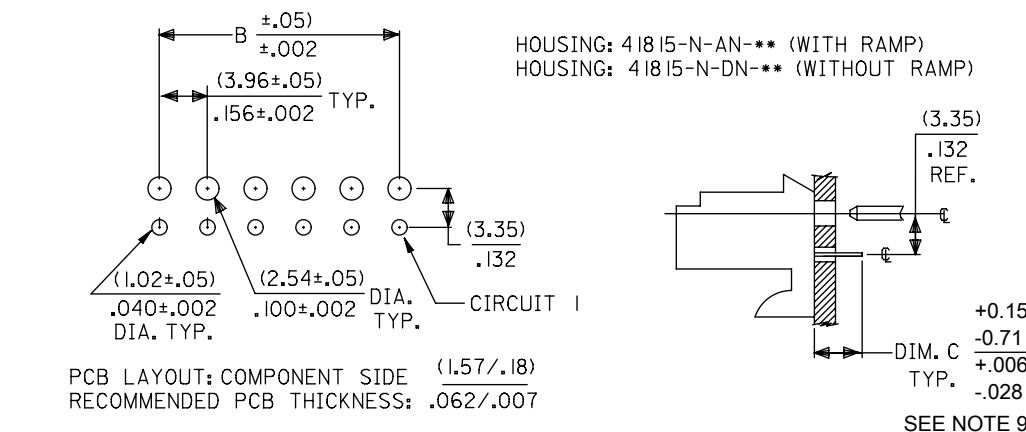

PCB LAYOUT: COMPONENT SIDE (1.57/.18)
RECOMMENDED PCB THICKNESS: .062/.007

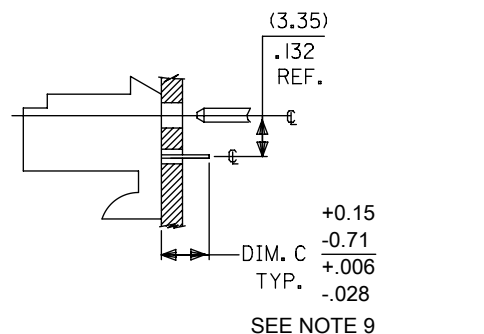

TOP ENTRY

HOUSING: 41815-N-AN-*** (WITH RAMP)
HOUSING: 41815-N-DN-*** (WITHOUT RAMP)

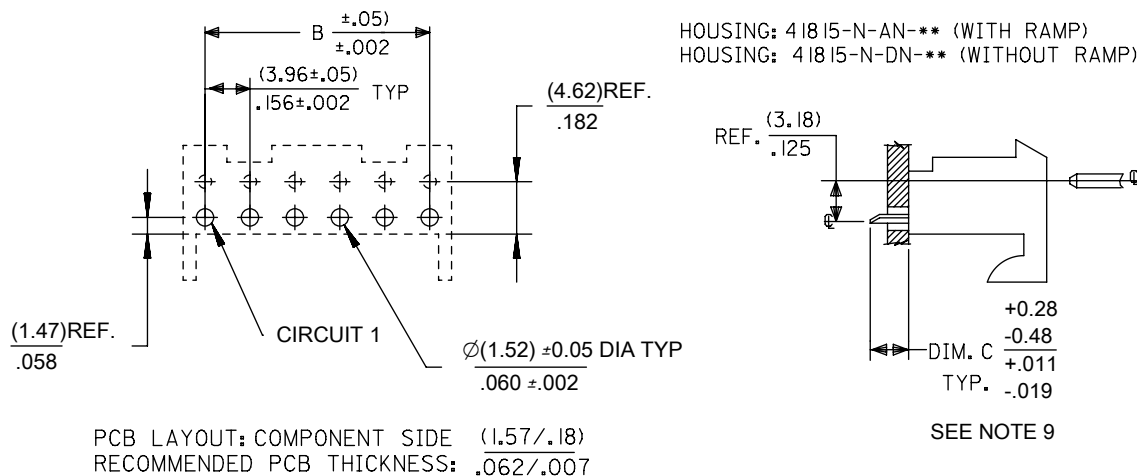

PCB LAYOUT: COMPONENT SIDE (1.57/.18)
RECOMMENDED PCB THICKNESS: .062/.007

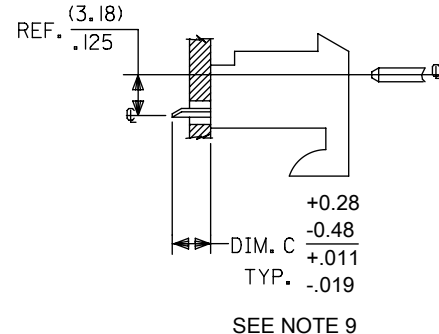

DIM. B	DIM. A	NO. OF CKTS
(3.96)	(7.82±.25)	2
.156	.308±.010	2
(7.92)	(11.79±.25)	3
.312	.464±.010	3
(11.89)	(15.75±.25)	4
.468	.620±.010	4
(15.85)	(19.71±.25)	5
.624	.776±.010	5
(19.81)	(23.67±.25)	6
.780	.932±.010	6
(23.77)	(27.64±.30)	7
.936	1.088±.012	7
(27.74)	(31.60±.25)	8
1.092	1.244±.012	8
(31.70)	(35.56±.30)	9
1.248	1.400±.012	9
(35.66)	(39.52±.30)	10
1.404	1.556±.012	10
(39.62)	(43.48±.30)	11
1.560	1.712±.012	11
(43.59)	(47.45±.30)	12
1.716	1.868±.012	12
(47.55)	(51.41±.30)	13
1.872	2.024±.012	13
(51.51)	(55.37±.36)	14
2.028	2.180±.014	14
(55.47)	(59.33±.36)	15
2.184	2.336±.014	15

NOTES:

- MATERIAL: HOUSING: POLYESTER, RATED UL 94V-0, COLOR: NATURAL (WHITE)
- FINISH:
 - (197) = OVERALL REFLOWED MATTE TIN: 0.00152/.000060 MIN OVER 0.00127/.000050 MIN NICKEL.
 - (208) = SELECT GOLD: 0.00038/.000015 MIN, SELECT TIN: 0.00254/.000100 MIN, OVERALL NICKEL UNDERPLATE: 0.00127/.000050 MIN.
 - (228) = SELECT GOLD: 0.00076/.000030 MIN, SELECT TIN: 0.00254/.000100 MIN, OVERALL NICKEL UNDERPLATE: 0.00127/.000050 MIN.
 - (909) = OVERALL TIN: 0.00254/.000100 MIN.
- PRODUCT SPECIFICATION: PS-08-50
- PACKAGING: SEE CHARTS
- FOR TOP ENTRY AND RIGHT ANGLE ASSEMBLIES WITH LOWER INSERTION FORCE USE SINGLE BEAM CONTACT. (TERMINAL NO. 4244)
- SOLDERABILITY: WHEN PARTS ARE SOLDERED AT A TEMPERATURE OF 230°C (446°F) FOR 5 SECONDS EACH SOLDERED SURFACE SHALL BE A MINIMUM OF 95% COVERED WITH A SMOOTH CONTINUOUS ADHERENT COATING. FOR ADDITIONAL INFORMATION SEE SMES-152.
- PARTS ARE STACKABLE END TO END ON (3.96)/.156 CENTERLINE.
- THIS PART CONFORMS TO CLASS B REQUIREMENTS OF COSMETIC SPEC PS-45499-002.
- DIMENSION 'C' MEASURED WITH TERMINAL PUSHED IN AGAINST THE STOP.

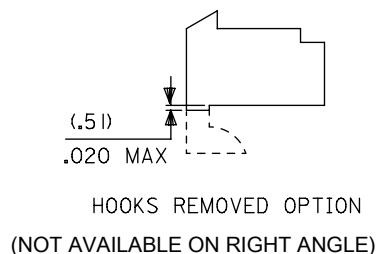

HOOKS REMOVED OPTION
(NOT AVAILABLE ON RIGHT ANGLE)

QUALITY SYMBOLS	THIS DRAWING CONTAINS INFORMATION THAT IS PROPRIETARY TO MOLEX ELECTRONIC TECHNOLOGIES, LLC AND SHOULD NOT BE USED WITHOUT WRITTEN PERMISSION								
FA = 0	DIM C TOLERANCE EC NO: 107740 DRWN: MKIPPER CHK'D: JBELL APPR: FSMITH 2016/08/22 2016/08/24 2016/08/26	GENERAL TOLERANCES (UNLESS SPECIFIED)		DIMENSION UNITS	SCALE				
FB = 0		MM	INCH	MM/IN	NTS				
FC = 0		4 PLACES	±	±	DRWN BY		DATE		
FD = 0		3 PLACES	±	± 0.01	SAMIEC		1987/01/28		
FE = 0		2 PLACES	± 0.25	± 0.015	CHK'D BY		DATE		
FF = 0		1 PLACES	± 0.38	±	SAMIEC		1987/01/28		
FG = 0		0 PLACES	±	±	APPR BY		DATE		
FH = 0		ANGULAR TOL ± 0.5		SAMIEC	1987/01/28				
FI = 0		DRAFT WHERE APPLICABLE MUST REMAIN WITHIN DIMENSIONS		DRAWING SIZE	THIRD ANGLE PROJECTION				
FJ = 0		B							
RELEASE STATUS		RELEASE DATE		SERIES		MATERIAL NUMBER		CUSTOMER	
				41815		SEE CHART		GENERAL MARKET	
				DOCUMENT NUMBER		DOC TYPE		DOC PART	
				SDA-41815		PSD		000	
				SHEET NUMBER				1 OF *	



KK 156 PCB ASSY 2-15 CKT

41815 SERIES

Assy. Proc:	RIGHT ANGLE
Housing No:	41815-N-AN
Options	WITH RAMP
Terminal No:	2144-BA-A1AA-197B
Term Matl:	PHOS BRONZE
Plating:	197 TIN
Dim C:	(3.68) / .145
Voids:	NONE
Hooks Cut:	NO
Packaging:	PK-41815-001 TRAY

Assy. Proc:	RIGHT ANGLE
Housing No:	41815-N-AN
Options	WITH RAMP
Terminal No:	2144-BA-A1AA-208B
Term Matl:	PHOS BRONZE
Plating:	208 – 15 GOLD
Dim C:	(3.68) / .145
Voids:	NONE
Hooks Cut:	NO
Packaging:	PK-41815-001 TRAY

Assy. Proc:	BOTTOM ENTRY
Housing No:	41815-N-AN
Options	WITH RAMP
Terminal No:	6298-1-197
Term Matl:	PHOS BRONZE
Plating:	197 – TIN
Dim C:	(3.18)/. 125
Voids:	NONE
Hooks Cut:	NO
Packaging:	PK-41815-001 TRAY

Assy. Proc:	BOTTOM ENTRY
Housing No:	41815-N-AN
Options	WITH RAMP
Terminal No:	6298-1-208
Term Matl:	PHOS BRONZE
Plating:	208 – 15 GOLD
Dim C:	(3.18)/. 125
Voids:	NONE
Hooks Cut:	NO
Packaging:	PK-41815-001 TRAY

Ckts	Material No	Engineer Number
2	09-48-1024	A-41815-0002
3	09-48-1034	A-41815-0003
4	09-48-1044	A-41815-0004
5	09-48-1054	A-41815-0005
6	09-48-1064	A-41815-0006
7	09-48-1074	A-41815-0007
8	09-48-1084	A-41815-0008
9	09-48-1094	A-41815-0009
10	09-48-1104	A-41815-0010
11	09-48-1114	A-41815-0011
12	09-48-1124	A-41815-0012
13	09-48-1134	A-41815-0013
14	09-48-1144	A-41815-0014
15	09-48-1154	A-41815-0015

Material No	Engineer Number
09-48-5024	A-41815-0016
09-48-5034	A-41815-0017
09-48-5044	A-41815-0018
09-48-5054	A-41815-0019
09-48-5064	A-41815-0020
09-48-5074	A-41815-0021
09-48-5084	A-41815-0022
09-48-5094	A-41815-0023
09-48-5104	A-41815-0024
09-48-5114	A-41815-0025
09-48-5124	A-41815-0026
09-48-5134	A-41815-0027
09-48-5144	A-41815-0028
09-48-5154	A-41815-0029

Material No	Engineer Number
09-48-4029	A-41815-0030
09-48-4039	A-41815-0031
09-48-4049	A-41815-0032
09-48-4059	A-41815-0033
09-48-4069	A-41815-0034
09-48-4079	A-41815-0035
09-48-4089	A-41815-0036
09-48-4099	A-41815-0037
09-48-4109	A-41815-0038
09-48-4119	A-41815-0039
09-48-4129	A-41815-0040
09-48-4139	A-41815-0041
09-48-4149	A-41815-0042
09-48-4159	A-41815-0043

Material No	Engineer Number
09-48-5026	A-41815-0044
09-48-5036	A-41815-0045
09-48-5046	A-41815-0046
09-48-5056	A-41815-0047
09-48-5066	A-41815-0048
09-48-5076	A-41815-0049
09-48-5086	A-41815-0050
09-48-5096	A-41815-0051
09-48-5106	A-41815-0052
09-48-5116	A-41815-0053
09-48-5126	A-41815-0054
09-48-5136	A-41815-0055
09-48-5146	A-41815-0056
09-48-5156	A-41815-0057

AN4	<u>REV:</u>		<u>ECR/ECN INFORMATION:</u>		KK 156 HOUSING ASSY PCB 41815 SERIES DWG			<u>SHEET No.</u>
			<u>EC NO.</u>	121254				- 2 -
			<u>DATE:</u>	8/30/2017				
<u>DOCUMENT NUMBER:</u>			<u>CREATED / REVISED BY:</u>		<u>CHECKED BY:</u>		<u>APPROVED BY:</u>	
SDA-41815			SS06		SS06		ISHWARG	



KK 156 PCB ASSY 2-15 CKT

41815 SERIES

	Assy. Proc:	TOP ENTRY	Assy. Proc:	TOP ENTRY	Assy. Proc:	BOTTOM ENTRY	Assy. Proc:	TOP ENTRY
	Housing No:	41815-N-AN	Housing No:	41815-N-AN	Housing No:	41815-N-AN	Housing No:	41815-N-AN
	Options	WITH RAMP	Options	WITH RAMP	Options	WITH RAMP	Options	WITH RAMP
	Terminal No:	2144-BA-A1AA-197B	Terminal No:	2144-BA-A1AA-208B	Terminal No:	2188-1-P909	Terminal No:	2144-AA-A1AA-P909B
	Term Matl:	PHOS BRONZE	Term Matl:	PHOS BRONZE	Term Matl:	BRASS	Term Matl:	BRASS
	Plating:	197 – TIN	Plating:	208 – 15 GOLD	Plating:	P909 – TIN	Plating:	P909 – TIN
	Dim C:	(3.05) / .120	Dim C:	(3.05) / .120	Dim C:	(3.18) / .125	Dim C:	(3.05) / .120
	Voids:	NONE	Voids:	NONE	Voids:	NONE	Voids:	NONE
	Hooks Cut:	NO	Hooks Cut:	NO	Hooks Cut:	NO	Hooks Cut:	YES
	Packaging:	PK-41815-001 TRAY	Packaging:	PK-41815-001 TRAY	Packaging:	PK-41815-001 TRAY	Packaging:	PK-41815-001 TRAY
Ckts	Material No	Engineer Number	Material No	Engineer Number	Material No	Engineer Number	Material No	Engineer Number
2	09-48-4028	A-41815-0058	09-48-5025	A-41815-0072	09-48-2022	A-41815-0100	09-48-2025	A-41815-0114
3	09-48-4038	A-41815-0059	09-48-5035	A-41815-0073	09-48-2032	A-41815-0101	09-48-2035	A-41815-0115
4	09-48-4048	A-41815-0060	09-48-5045	A-41815-0074	09-48-2042	A-41815-0102	09-48-2045	A-41815-0116
5	09-48-4058	A-41815-0061	09-48-5055	A-41815-0075	09-48-2052	A-41815-0103	09-48-2055	A-41815-0117
6	09-48-4068	A-41815-0062	09-48-5065	A-41815-0076	09-48-2062	A-41815-0104	09-48-2065	A-41815-0118
7	09-48-4078	A-41815-0063	09-48-5075	A-41815-0077	09-48-2072	A-41815-0105	09-48-2075	A-41815-0119
8	09-48-4088	A-41815-0064	09-48-5085	A-41815-0078	09-48-2082	A-41815-0106	09-48-2085	A-41815-0120
9	09-48-4098	A-41815-0065	09-48-5095	A-41815-0079	09-48-2092	A-41815-0107	09-48-2095	A-41815-0121
10	09-48-4108	A-41815-0066	09-48-5105	A-41815-0080	09-48-2102	A-41815-0108	09-48-2105	A-41815-0122
11	09-48-4118	A-41815-0067	09-48-5115	A-41815-0081	09-48-2112	A-41815-0109	09-48-2115	A-41815-0123
12	09-48-4128	A-41815-0068	09-48-5125	A-41815-0082	09-48-2122	A-41815-0110	09-48-2125	A-41815-0124
13	09-48-4138	A-41815-0069	09-48-5135	A-41815-0083	09-48-2132	A-41815-0111	09-48-2135	A-41815-0125
14	09-48-4148	A-41815-0070	09-48-5145	A-41815-0084	09-48-2142	A-41815-0112	09-48-2145	A-41815-0126
15	09-48-4158	A-41815-0071	09-48-5155	A-41815-0085	09-48-2152	A-41815-0113	09-48-2155	A-41815-0127

AN4	<u>REV:</u>		<u>ECR/ECN INFORMATION:</u>		KK 156 HOUSING ASSY PCB 41815 SERIES DWG			<u>SHEET No.</u>
			<u>EC NO.</u>	121254				- 3 -
			<u>DATE:</u>	8/30/2017				
<u>DOCUMENT NUMBER:</u>			<u>CREATED / REVISED BY:</u>		<u>CHECKED BY:</u>		<u>APPROVED BY:</u>	
SDA-41815			SS06		SS06		ISHWARG	



KK 156 PCB ASSY 2-15 CKT

41815 SERIES

Ckts	Assy. Proc:		Assy. Proc:		Assy. Proc:		Assy. Proc:	
	Material No	Engineer Number	Material No	Engineer Number	Material No	Engineer Number	Material No	Engineer Number
2			09-48-4021	A-41815-0170	41815-0184	A-41815-0184	09-48-2021	A-41815-0198
3			09-48-4031	A-41815-0171	09-48-5030	A-41815-0185	09-48-2031	A-41815-0199
4			09-48-4041	A-41815-0172	09-48-5040	A-41815-0186	09-48-2041	A-41815-0200
5			09-48-4051	A-41815-0173	09-48-5050	A-41815-0187	09-48-2051	A-41815-0201
6			09-48-4061	A-41815-0174	41815-0188	A-41815-0188	09-48-2061	A-41815-0202
7			09-48-4071	A-41815-0175	41815-0189	A-41815-0189	09-48-2071	A-41815-0203
8			09-48-4081	A-41815-0176	09-48-5080	A-41815-0190	09-48-2081	A-41815-0204
9			09-48-4091	A-41815-0177	41815-0191	A-41815-0191	09-48-2091	A-41815-0205
10			09-48-4101	A-41815-0178	09-48-5100	A-41815-0192	09-48-2101	A-41815-0206
11			09-48-4111	A-41815-0179	41815-0193	A-41815-0193	09-48-2111	A-41815-0207
12			09-48-4121	A-41815-0180	41815-0194	A-41815-0194	09-48-2121	A-41815-0208
13			09-48-4131	A-41815-0181	41815-0195	A-41815-0195	09-48-2131	A-41815-0209
14			09-48-4141	A-41815-0182	41815-0196	A-41815-0196	09-48-2141	A-41815-0210
15			09-48-4151	A-41815-0183	41815-0197	A-41815-0197	09-48-2151	A-41815-0211

AN4	ECR/ECN INFORMATION:		TITLE: KK 156 HOUSING ASSY PCB 41815 SERIES DWG	SHEET No.
	EC NO.	121254		- 4 -
	DATE:	8/30/2017		
DOCUMENT NUMBER: SDA-41815		CREATED / REVISED BY: SS06	CHECKED BY: SS06	APPROVED BY: ISHWARG



KK 156 PCB ASSY 2-15 CKT

41815 SERIES

Ckts	Material No	Engineer Number	Material No	Engineer Number	Material No	Engineer Number	Material No	Engineer Number
2	09-48-5023	A-41815-0313	41815-0327	A-41815-0327			41815-0355	A-41815-0355
3	09-48-5033	A-41815-0314	41815-0328	A-41815-0328			41815-0356	A-41815-0356
4	09-48-5043	A-41815-0315	41815-0329	A-41815-0329			09-48-2047	A-41815-0357
5	09-48-5053	A-41815-0316	09-48-2056	A-41815-0330			41815-0358	A-41815-0358
6	09-48-5063	A-41815-0317	41815-0331	A-41815-0331			41815-0359	A-41815-0359
7	09-48-5073	A-41815-0318	41815-0332	A-41815-0332			41815-0360	A-41815-0360
8	09-48-5083	A-41815-0319	09-48-2086	A-41815-0333			41815-0361	A-41815-0361
9	09-48-5093	A-41815-0320	41815-0334	A-41815-0334			41815-0362	A-41815-0362
10	09-48-5103	A-41815-0321	09-48-2106	A-41815-0335			09-48-2107	A-41815-0363
11	09-48-5113	A-41815-0322	41815-0336	A-41815-0336			41815-0364	A-41815-0364
12	09-48-5123	A-41815-0323	41815-0337	A-41815-0337			41815-0365	A-41815-0365
13	09-48-5133	A-41815-0324	41815-0338	A-41815-0338			41815-0366	A-41815-0366
14	09-48-5143	A-41815-0325	41815-0339	A-41815-0339			41815-0367	A-41815-0367
15	09-48-5153	A-41815-0326	41815-0340	A-41815-0340			41815-0368	A-41815-0368

REV:	ECR/ECN INFORMATION:	TITLE:			SHEET No.	
AN4	EC NO.	121254		<h1 style="margin: 0;">KK 156 HOUSING ASSY PCB</h1> <h2 style="margin: 0;">41815 SERIES DWG</h2>		- 5 -
	DATE:	8/30/2017				
DOCUMENT NUMBER:		CREATED / REVISED BY:		CHECKED BY:		APPROVED BY:
SDA-41815		SS06		SS06		ISHWARG



KK 156 PCB ASSY 2-15 CKT

41815 SERIES

	Assy. Proc:	RIGHT ANGLE	Assy. Proc:	RIGHT ANGLE	Assy. Proc:	RIGHT ANGLE	Assy. Proc:	BOTTOM ENTRY
	Housing No:	41815-N-AN	Housing No:	41815-N-AN	Housing No:	41815-N-AN	Housing No:	41815-N-AN
	Options	WITH RAMP	Options	WITH RAMP	Options	WITH RAMP	Options	WITH RAMP
	Terminal No:	4244-A-197A	Terminal No:	2144-AA-A1AA-208B	Terminal No:	2188-1-208	Terminal No:	2188-1-208
	Term Matl:	PHOS BRONZE	Term Matl:	BRASS	Term Matl:	BRASS	Term Matl:	BRASS
	Plating:	197 – TIN	Plating:	208 – 15 GOLD	Plating:	208 – 15 GOLD	Plating:	208 – 15 GOLD
	Dim C:	(3.68) / .145	Dim C:	(3.68) / .145	Dim C:	(3.18) / .125	Dim C:	(3.18) / .125
	Voids:	NONE	Voids:	NONE	Voids:	NONE	Voids:	NONE
	Hooks Cut:	NO	Hooks Cut:	NO	Hooks Cut:	NO	Hooks Cut:	NO
	Packaging:	PK-41815-001 TRAY	Packaging:	PK-41815-001 TRAY	Packaging:	PK-41815-001 TRAY	Packaging:	PK-41815-001 TRAY
Ckts	Material No	Engineer Number	Material No	Engineer Number	Material No	Engineer Number	Material No	Engineer Number
2	09-48-1023	A-41815-0369			09-48-3025	A-41815-0425	09-48-3024	A-41815-0439
3	09-48-1033	A-41815-0370			09-48-3035	A-41815-0426	09-48-3034	A-41815-0440
4	09-48-1043	A-41815-0371			09-48-3045	A-41815-0427	09-48-3044	A-41815-0441
5	09-48-1053	A-41815-0372			09-48-3055	A-41815-0428	09-48-3054	A-41815-0442
6	09-48-1063	A-41815-0373			09-48-3065	A-41815-0429	09-48-3064	A-41815-0443
7	09-48-1073	A-41815-0374			09-48-3075	A-41815-0430	09-48-3074	A-41815-0444
8	09-48-1083	A-41815-0375			09-48-3085	A-41815-0431	09-48-3084	A-41815-0445
9	09-48-1093	A-41815-0376			09-48-3095	A-41815-0432	09-48-3094	A-41815-0446
10	09-48-1103	A-41815-0377			09-48-3105	A-41815-0433	09-48-3104	A-41815-0447
11	09-48-1113	A-41815-0378			09-48-3115	A-41815-0434	09-48-3114	A-41815-0448
12	09-48-1123	A-41815-0379			09-48-3125	A-41815-0435	09-48-3124	A-41815-0449
13	09-48-1133	A-41815-0380			09-48-3135	A-41815-0436	09-48-3134	A-41815-0450
14	09-48-1143	A-41815-0381			09-48-3145	A-41815-0437	09-48-3144	A-41815-0451
15	09-48-1153	A-41815-0382			09-48-3155	A-41815-0438	09-48-3154	A-41815-0452

REV:	ECR/ECN INFORMATION:	TITLE:	SHEET No.
AN4	EC NO. 121254	KK 156 HOUSING ASSY PCB 41815 SERIES DWG	- 6 -
	DATE: 8/30/2017		
DOCUMENT NUMBER:		CREATED / REVISED BY:	CHECKED BY:
SDA-41815		SS06	SS06
		APPROVED BY:	
		ISHWARG	



KK 156 PCB ASSY 2-15 CKT

41815 SERIES

Assy. Proc:	TOP ENTRY
Housing No:	41815-N-AN
Options	WITH RAMP
Terminal No:	2144-AA-A1AA-P909B
Term Matl:	BRASS
Plating:	P909 – TIN
Dim C:	(3.05) / .120
Voids:	NONE
Hooks Cut:	NO
Packaging:	PK-41815-001 TRAY

Assy. Proc:	TOP ENTRY
Housing No:	41815-N-AN
Options	WITH RAMP
Terminal No:	2144-AA-A1AA-208B
Term Matl:	BRASS
Plating:	208 – 15 GOLD
Dim C:	(3.05) / .120
Voids:	NONE
Hooks Cut:	NO
Packaging:	PK-41815-001 TRAY

Assy. Proc:	RIGHT ANGLE
Housing No:	41815-N-AN
Options	WITH RAMP
Terminal No:	2144-BA-A1AA-P909B
Term Matl:	PHOS BRONZE
Plating:	P909 – TIN
Dim C:	(3.68) / .145
Voids:	NONE
Hooks Cut:	NO
Packaging:	PK-41815-001 TRAY

Assy. Proc:	BOTTOM ENTRY
Housing No:	41815-N-AN
Options	WITH RAMP
Terminal No:	6298-1-P909
Term Matl:	PHOS BRONZE
Plating:	P909 – TIN
Dim C:	(3.18) / .125
Voids:	NONE
Hooks Cut:	NO
Packaging:	PK-41815-001 TRAY

Ckts	Material No	Engineer Number
2	09-48-2023	A-41815-0453
3	09-48-2033	A-41815-0454
4	09-48-2043	A-41815-0455
5	09-48-2053	A-41815-0456
6	09-48-2063	A-41815-0457
7	09-48-2073	A-41815-0458
8	09-48-2083	A-41815-0459
9	09-48-2093	A-41815-0460
10	09-48-2103	A-41815-0461
11	09-48-2113	A-41815-0462
12	09-48-2123	A-41815-0463
13	09-48-2133	A-41815-0464
14	09-48-2143	A-41815-0465
15	09-48-2153	A-41815-0466

Material No	Engineer Number
09-48-3026	A-41815-0467
09-48-3036	A-41815-0468
09-48-3046	A-41815-0469
09-48-3056	A-41815-0470
09-48-3066	A-41815-0471
09-48-3076	A-41815-0472
09-48-3086	A-41815-0473
09-48-3096	A-41815-0474
09-48-3106	A-41815-0475
09-48-3116	A-41815-0476
09-48-3126	A-41815-0477
09-48-3136	A-41815-0478
09-48-3146	A-41815-0479
09-48-3156	A-41815-0480

Material No	Engineer Number
09-48-2020	A-41815-0481
09-48-2030	A-41815-0482
09-48-2040	A-41815-0483
09-48-2050	A-41815-0484
09-48-2060	A-41815-0485
09-48-2070	A-41815-0486
09-48-2080	A-41815-0487
09-48-2090	A-41815-0488
09-48-2100	A-41815-0489
09-48-2110	A-41815-0490
09-48-2120	A-41815-0491
09-48-2130	A-41815-0492
09-48-2140	A-41815-0493
09-48-2150	A-41815-0494

Material No	Engineer Number
09-48-2029	A-41815-0495
09-48-2039	A-41815-0496
09-48-2049	A-41815-0497
09-48-2059	A-41815-0498
09-48-2069	A-41815-0499
09-48-2079	A-41815-0500
09-48-2089	A-41815-0501
09-48-2099	A-41815-0502
09-48-2109	A-41815-0503
09-48-2119	A-41815-0504
09-48-2129	A-41815-0505
09-48-2139	A-41815-0506
09-48-2149	A-41815-0507
09-48-2159	A-41815-0508

REV: AN4	ECR/ECN INFORMATION:		TITLE: KK 156 HOUSING ASSY PCB 41815 SERIES DWG	SHEET No.
	EC NO.	121254		- 7 -
	DATE:	8/30/2017		
DOCUMENT NUMBER: SDA-41815		CREATED / REVISED BY: SS06	CHECKED BY: SS06	APPROVED BY: ISHWARG



KK 156 PCB ASSY 2-15 CKT

41815 SERIES

Assy. Proc:	TOP ENTRY
Housing No:	41815-N-AN
Options	WITH RAMP
Terminal No:	2144-BA-A1AA-P909B
Term Matl:	PHOS BRONZE
Plating:	P909 – TIN
Dim C:	(3.05) / .120
Voids:	NONE
Hooks Cut:	NO
Packaging:	PK-41815-001 TRAY

Assy. Proc:	TOP ENTRY
Housing No:	41815-N-AN
Options	WITH RAMP
Terminal No:	2144-BA-A1AA-197B
Term Matl:	PHOS BRONZE
Plating:	197 – TIN
Dim C:	(3.05) / .120
Voids:	NONE
Hooks Cut:	YES
Packaging:	PK-41815-001 TRAY

Assy. Proc:	TOP ENTRY
Housing No:	41815-N-AN
Options	WITH RAMP
Terminal No:	2144-BA-A1AA-208B
Term Matl:	PHOS BRONZE
Plating:	208 – 15 GOLD
Dim C:	(3.05) / .120
Voids:	NONE
Hooks Cut:	YES
Packaging:	PK-41815-001 TRAY

Assy. Proc:	BOTTOM ENTRY
Housing No:	41815-N-AN
Options	WITH RAMP
Terminal No:	2188-1-208
Term Matl:	BRASS
Plating:	208 – 15 GOLD
Dim C:	(3.18) / .125
Voids:	TERMINAL VOID 2
Hooks Cut:	NO
Packaging:	PK-41815-001 TRAY

Ckts	Material No	Engineer Number
2	09-48-2028	A-41815-0509
3	09-48-2038	A-41815-0510
4	09-48-2048	A-41815-0511
5	09-48-2058	A-41815-0512
6	09-48-2068	A-41815-0513
7	09-48-2078	A-41815-0514
8	09-48-2088	A-41815-0515
9	09-48-2098	A-41815-0516
10	09-48-2108	A-41815-0517
11	09-48-2118	A-41815-0518
12	09-48-2128	A-41815-0519
13	09-48-2138	A-41815-0520
14	09-48-2148	A-41815-0521
15	09-48-2158	A-41815-0522

Material No	Engineer Number
09-48-5028	A-41815-0523
09-48-5038	A-41815-0524
09-48-5048	A-41815-0525
09-48-5058	A-41815-0526
09-48-5068	A-41815-0527
09-48-5078	A-41815-0528
09-48-5088	A-41815-0529
09-48-5098	A-41815-0530
09-48-5108	A-41815-0531
09-48-5118	A-41815-0532
09-48-5128	A-41815-0533
09-48-5138	A-41815-0534
09-48-5148	A-41815-0535
09-48-5158	A-41815-0536

Material No	Engineer Number
09-48-1025	A-41815-0537
09-48-1035	A-41815-0538
09-48-1045	A-41815-0539
09-48-1055	A-41815-0540
09-48-1065	A-41815-0541
09-48-1075	A-41815-0542
09-48-1085	A-41815-0543
09-48-1095	A-41815-0544
09-48-1105	A-41815-0545
09-48-1115	A-41815-0546
09-48-1125	A-41815-0547
09-48-1135	A-41815-0548
09-48-1145	A-41815-0549
09-48-1155	A-41815-0550

Material No	Engineer Number
41815-0551	41815-0551
41815-0552	41815-0552
41815-0553	41815-0553
41815-0554	41815-0554
41815-0555	41815-0555
41815-0556	41815-0556
41815-0557	41815-0557
41815-0558	41815-0558
41815-0559	41815-0559
41815-0560	41815-0560
41815-0561	41815-0561
41815-0562	41815-0562
41815-0563	41815-0563

REV: AN4	ECR/ECN INFORMATION:		TITLE: KK 156 HOUSING ASSY PCB 41815 SERIES DWG	<u>SHEET No.</u>
	EC NO.	121254		- 8 -
	DATE:	8/30/2017		
DOCUMENT NUMBER: SDA-41815		CREATED / REVISED BY: SS06	CHECKED BY: SS06	APPROVED BY: ISHWARG



KK 156 PCB ASSY 2-15 CKT

41815 SERIES

	Assy. Proc:	BOTTOM ENTRY	Assy. Proc:	BOTTOM ENTRY	Assy. Proc:	RIGHT ANGLE	Assy. Proc:	TOP ENTRY
	Housing No:	41815-N-DN	Housing No:	41815-N-DN	Housing No:	41815-N-A15-7	Housing No:	41815-N-DN
	Options	WITHOUT RAMPS	Options	WITHOUT RAMPS	Options	WITH RAMP	Options	WITHOUT RAMP
	Terminal No:	6298-1-197	Terminal No:	6298-1-197	Terminal No:	2144-BA-A1AA-197B	Terminal No:	2144-BA-A1AA-197B
	Term Matl:	PHOS BRONZE	Term Matl:	PHOS BRONZE	Term Matl:	PHOS BRONZE	Term Matl:	PHOS BRONZE
	Plating:	197 – TIN	Plating:	197 – TIN	Plating:	197 – TIN	Plating:	197 – TIN
	Dim C:	3.18 / .125	Dim C:	3.18 / .125	Dim C:	(3.68) / .145	Dim C:	(3.05)/.120
	Voids:	NONE	Voids:	TERMINAL VOID 2	Voids:	TERMINAL VOID 7	Voids:	NONE
	Hooks Cut:	NO	Hooks Cut:	NO	Hooks Cut:	NO	Hooks Cut:	YES
	Packaging:	PK-41815-001 TRAY	Packaging:	PK-41815-001 TRAY	Packaging:	PK-41815-001 TRAY	Packaging:	PK-41815-001 TRAY
Ckts	Material No	Engineer Number	Material No	Engineer Number	Material No	Engineer Number	Material No	Engineer Number
2	41815-0564	A-41815-0564					41815-0601	A-41815-0601
3	41815-0565	A-41815-0565	41815-0579	A-41815-0579			41815-0602	A-41815-0602
4	41815-0566	A-41815-0566	41815-0580	A-41815-0580				
5	41815-0567	A-41815-0567	41815-0581	A-41815-0581				
6	41815-0568	A-41815-0568	41815-0582	A-41815-0582			41815-0605	A-41815-0605
7	41815-0569	A-41815-0569	41815-0583	A-41815-0583				
8	41815-0570	A-41815-0570	41815-0584	A-41815-0584				
9	41815-0571	A-41815-0571	41815-0585	A-41815-0585				
10	41815-0572	A-41815-0572	41815-0586	A-41815-0586				
11	41815-0573	A-41815-0573	41815-0587	A-41815-0587				
12	41815-0574	A-41815-0574	41815-0588	A-41815-0588				
13	41815-0575	A-41815-0575	41815-0589	A-41815-0589				
14	41815-0576	A-41815-0576	41815-0590	A-41815-0590				
15	41815-0577	A-41815-0577	41815-0591	A-41815-0591	41815-0600	A-41815-0600		

AN4	<u>REV:</u>		<u>ECR/ECN INFORMATION:</u>		KK 156 HOUSING ASSY PCB 41815 SERIES DWG			<u>SHEET No.</u>
			<u>EC NO.</u>	121254				- 9 -
			<u>DATE:</u>	8/30/2017				
<u>DOCUMENT NUMBER:</u>			<u>CREATED / REVISED BY:</u>		<u>CHECKED BY:</u>		<u>APPROVED BY:</u>	
SDA-41815			SS06		SS06		ISHWARG	



KK 156 PCB ASSY 2-15 CKT

41815 SERIES

	Assy. Proc:	RIGHT ANGLE	Assy. Proc:	TOP ENTRY	Assy. Proc:	RIGHT ANGLE	Assy. Proc:	BOTTOM ENTRY
	Housing No:	41815-N-DN	Housing No:	41815-N-DN	Housing No:	41815-N-AN	Housing No:	41815-N-DN
	Options	WITHOUT RAMP	Options	WITHOUT RAMP	Options	WITH RAMP	Options	WITHOUT RAMP
	Terminal No:	2144-BA-A1AA-197B	Terminal No:	2144-AA-A1AA-P909B	Terminal No:	2144-BA-A1AA-197B	Terminal No:	6298-197
	Term Matl:	PHOS BRONZE	Term Matl:	BRASS	Term Matl:	PHOS BRONZE	Term Matl:	PHOS BRONZE
	Plating:	197 – TIN	Plating:	P909 – TIN	Plating:	197 TIN	Plating:	197 – TIN
	Dim C:	(3.68) / .145	Dim C:	(3.05) / .120	Dim C:	(3.68) / .145	Dim C:	(4.06) / .160
	Voids:	NONE	Voids:	NONE	Voids:	TERMINAL VOID 2, 4	Voids:	NONE
	Hooks Cut:	NO	Hooks Cut:	YES	Hooks Cut:	NO	Hooks Cut:	YES
	Packaging:	PK-41815-001 TRAY	Packaging:	PK-41815-001 TRAY	Packaging:	PK-41815-001 TRAY	Packaging:	PK-41815-001 TRAY
Ckts	Material No	Engineer Number	Material No	Engineer Number	Material No	Engineer Number	Material No	Engineer Number
2	41815-0630	A-41815-0630					41815-0672	A-41815-0672
3	41815-0631	A-41815-0631						
4	41815-0632	A-41815-0632	41815-0646	A-41815-0646			41815-0674	A-41815-0674
5	41815-0633	A-41815-0633			41815-0661	A-41815-0661		
6	41815-0634	A-41815-0634						
7	41815-0635	A-41815-0635						
8	41815-0636	A-41815-0636						
9	41815-0637	A-41815-0637						
10	41815-0638	A-41815-0638						
11	41815-0639	A-41815-0639						
12	41815-0640	A-41815-0640						
13	41815-0641	A-41815-0641						
14	41815-0642	A-41815-0642						
15	41815-0643	A-41815-0643						

REV: AN4	ECR/ECN INFORMATION:		TITLE: KK 156 HOUSING ASSY PCB 41815 SERIES DWG	SHEET No.
	EC NO.	121254		- 10 -
	DATE:	8/30/2017		
DOCUMENT NUMBER: SDA-41815		CREATED / REVISED BY: SS06	CHECKED BY: SS06	APPROVED BY: ISHWARG



KK 156 PCB ASSY 2-15 CKT

41815 SERIES

	Assy. Proc:	RIGHT ANGLE	Assy. Proc:	Assy. Proc:	Assy. Proc:
	Housing No:	41815-N-AN	Housing No:	Housing No:	Housing No:
	Options	WITH RAMP	Options	Options	Options
	Terminal No:	2144-BA-A1AA-197B	Terminal No:	Terminal No:	Terminal No:
	Term Matl:	PHOS BRONZE	Term Matl:	Term Matl:	Term Matl:
	Plating:	197 TIN	Plating:	Plating:	Plating:
	Dim C:	(3.68) / .145	Dim C:	Dim C:	Dim C:
	Voids:	TERMINAL VOID 2	Voids:	Voids:	Voids:
	Hooks Cut:	NO	Hooks Cut:	Hooks Cut:	Hooks Cut:
	Packaging:	PK-41815-001 TRAY	Packaging:	Packaging:	Packaging:
Ckts	Material No	Engineer Number	Material No	Material No	Material No
2					
3	41815-0687	A-41815-0687			
4					
5					
6					
7					
8					
9					
10					
11					
12					
13					
14					
15					

REV:	ECR/ECN INFORMATION:	TITLE:	SHEET No.
AN4	EC NO. 121254	KK 156 HOUSING ASSY PCB 41815 SERIES DWG	- 11 -
	DATE: 8/30/2017		
DOCUMENT NUMBER:		CREATED / REVISED BY:	CHECKED BY:
SDA-41815		SS06	SS06
		APPROVED BY:	
		ISHWARG	

Mouser Electronics

Authorized Distributor

Click to View Pricing, Inventory, Delivery & Lifecycle Information:

[Molex:](#)

[09-48-2021](#)