

# 4-Pin Super Flux White LED Lamp Orca R Series (5mm Dome)

# BIVAR

## R20WHT-5-0080

- ◆ RoHS Compliant
- ◆ Low Profile Dome Lens
- ◆ Automatic Insertion Compatible — Tubular Packaging
- ◆ Automatic Placement Compatible
- ◆ High Intensity Output
- ◆ High Power Efficiency



Bivar **R20WHT-5-0080** comes with low profile package design incorporating higher forward current to maximize intensity while minimizing the number of LEDs required to achieve uniform and enhanced light distribution. Low power consumption with quick response time means savings in electricity.

Bivar **R20WHT-5-0080** can be coupled with reflectors or lenses for optimal light distribution needs. Typical applications are automotive exterior lighting, decorative interior or exterior lighting, specialty stage lighting, and electronic signage.

| Part Number   | Material       | Emitted Color | Intensity Typ. mcd | Lens Color  | Viewing Angle |
|---------------|----------------|---------------|--------------------|-------------|---------------|
| R20WHT-5-0080 | InGaN/Sapphire | White         | 6000               | Water Clear | 80°           |

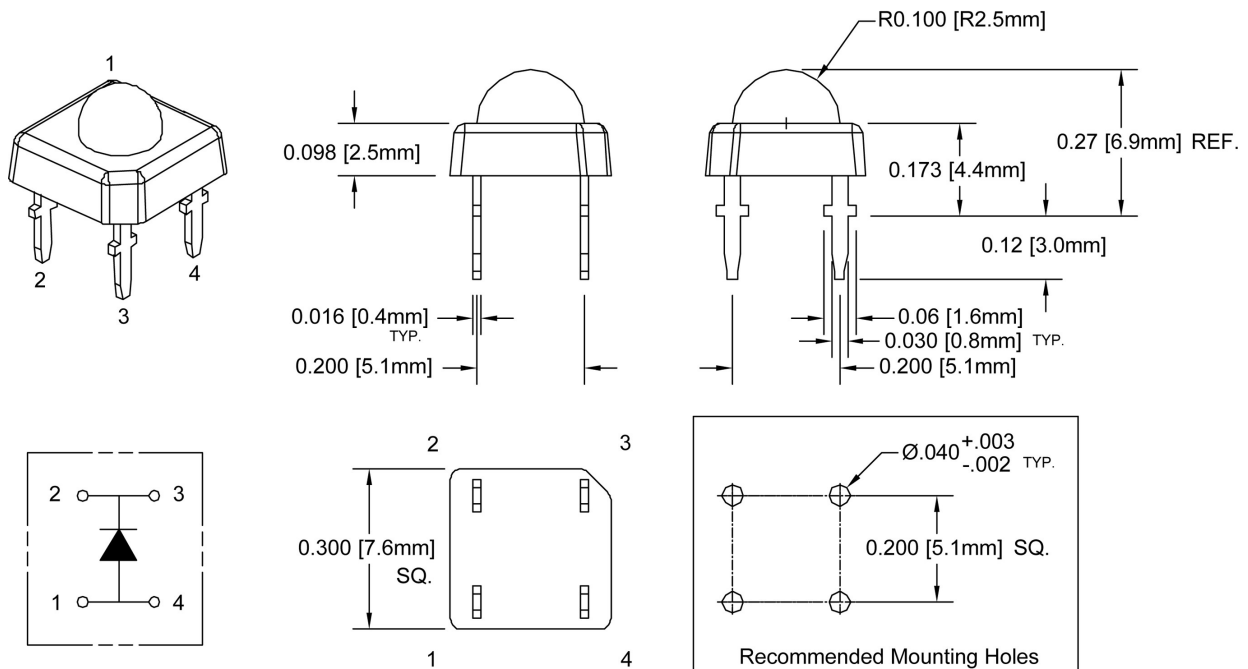

### Outline Drawings Notes:

1. All dimensions are in inches [millimeters].
2. Standard tolerance:  $\pm 0.010''$  unless otherwise noted.
3. Tolerance of overall epoxy outline:  $\pm 0.020''$  unless otherwise noted.
4. Epoxy meniscus may extend to 0.060" max.



Bivar reserves the right to make changes at any time.

# 4-Pin Super Flux White LED Lamp R20WHT-5-0080



## Absolute Maximum Ratings

$T_A = 25^\circ\text{C}$  unless otherwise noted

|  |             |
|--|-------------|
| Power Dissipation  | 220 mW      |
| Forward Current ( DC )   | 50 mA       |
| Peak Forward Current <sup>1</sup>  | 100 mA      |
| Electrostatic Discharge ( Class1 )   | 2000 V      |
| Reverse Voltage  | 5 V         |
| Operating Temperature Range  | -25 ~ +80°C |
| Storage Temperature Range  | -30 ~ +80°C |
| Lead Soldering Temperature ( 3 mm from the base of the epoxy bulb ) <sup>2</sup> | 260°C       |

- Notes: 1. 10% Duty Cycle, Pulse Width  $\leq 0.1$  msec.  
2. Solder time less than 5 seconds at temperature extreme.

## Electrical Characteristics

$T_A = 25^\circ\text{C}$  &  $I_F = 20$  mA unless otherwise noted

| Emitting Color | Forward Voltage (V) <sup>1</sup> |     |     | Recommend Forward Current (mA) | Reverse Current ( $\mu\text{A}$ )<br>$V_R=5\text{V}$ | Chromaticity Coordinates (XY) <sup>2</sup> / CCT (Kelvin) | Luminous Intensity (mcd) <sup>3</sup> |      | Viewing Angle $2\theta_{1/2}$ (deg) |
|----------------|----------------------------------|-----|-----|--------------------------------|--|---|---------------------------------------|------|-------------------------------------|
|                | MIN                              | TYP | MAX | TYP                            | MAX  | TYP   | MIN                                   | TYP  | TYP                                 |
| White          | 2.7                              | 3.2 | 3.6 | 20                             | 10   | X=0.31, Y=0.33<br>6000K                                   | 3000                                  | 6000 | 80                                  |

- Notes: 1. Tolerance of Forward Voltage :  $\pm 0.05\text{V}$ .  
2. Tolerance of Chromaticity Coordinates :  $\pm 0.02$ .  
3. Tolerance of Luminous Intensity :  $\pm 15\%$ .

## Directivity Radiation

$T_A = 25^\circ\text{C}$  unless otherwise noted

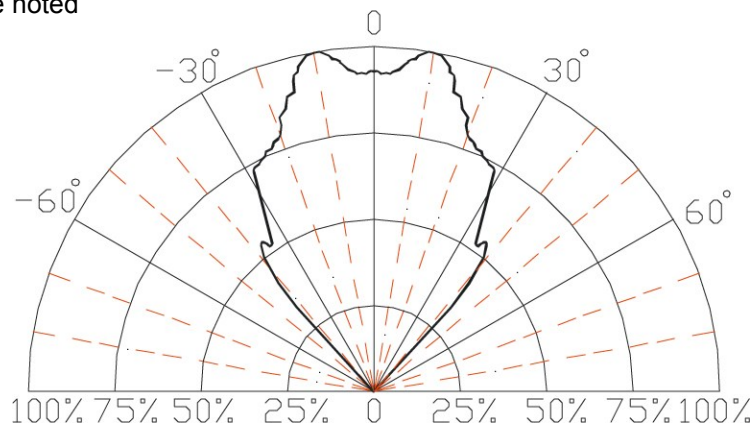

Relative Luminous Intensity vs. Radiation Angle

Bivar reserves the right to make changes at any time.

# 4-Pin Super Flux White LED Lamp R20WHT-5-0080



## Typical Electrical / Optical Characteristics Curves

$T_A = 25^\circ\text{C}$  unless otherwise noted

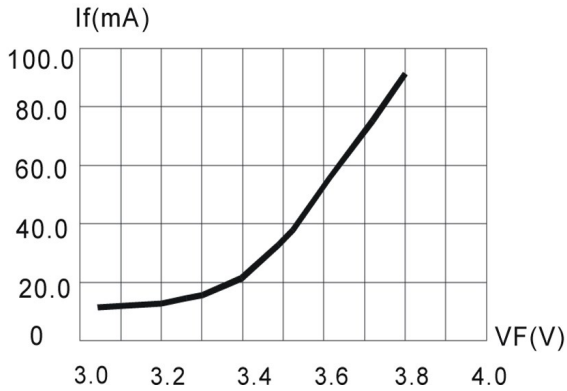

Fig.1 Forward Current vs. Forward Voltage

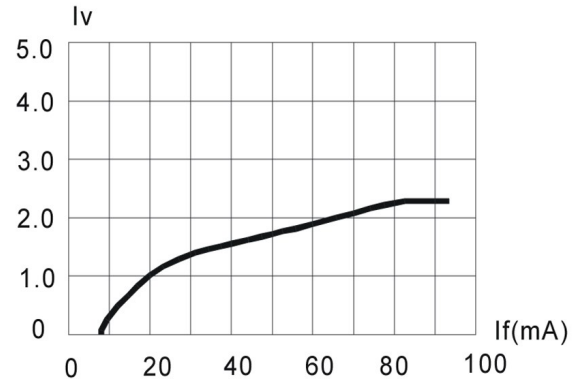

Fig.2 Relative Luminous Intensity vs. Forward Current

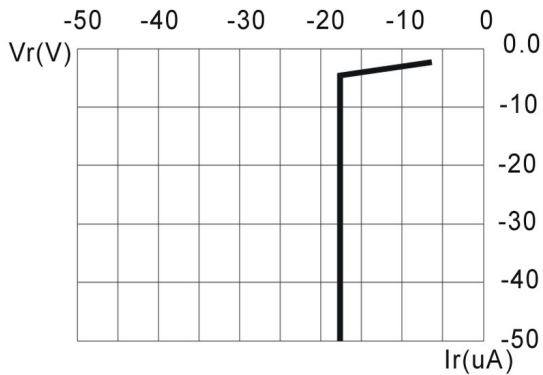

Fig.3 Reverse Current vs. Reverse Voltage

Half Width =  $\Delta\lambda_{35\text{nm}}$   
Domi WL = 470nm

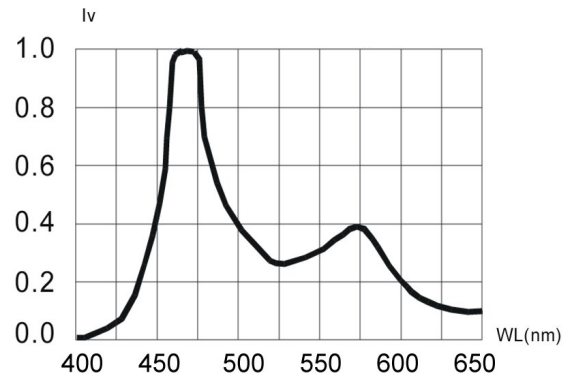

Fig.4 Relative Luminous Intensity vs. Wavelength

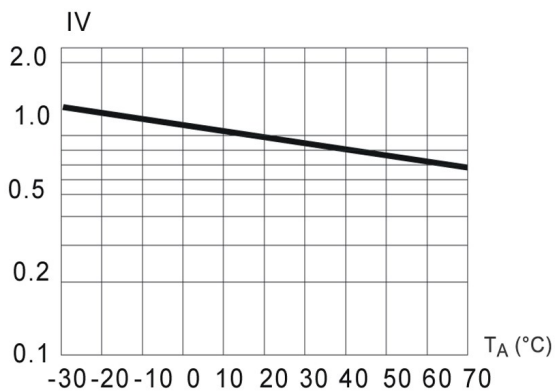

Fig.5 Relative Luminous Intensity vs. Ambient Temperature

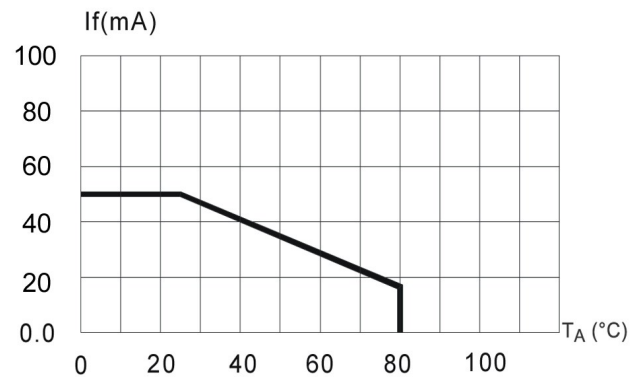

Fig.6 Maximum Forward Current vs. Ambient Temperature

Bivar reserves the right to make changes at any time.

# 4-Pin Super Flux White LED Lamp R20WHT-5-0080



## Recommended Soldering Conditions

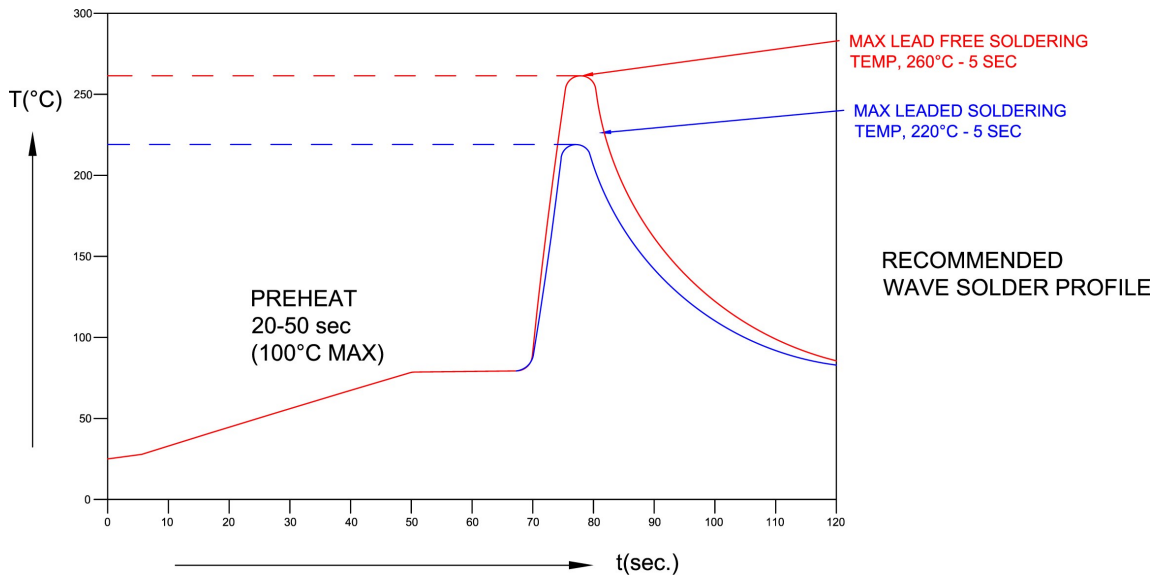

| Recommended Lead Free Wave Soldering Profile   |   |
|--|---|
| Preheat Temperature: 100°C Max.  | Peak Temperature: 260°C Max.            |
| Preheat Time: 20 ~ 50 Seconds  | Solder Time Above 217°C: 5 Seconds Max. |
| Note: Turn off top heater at preheat to prevent the lamp body directly exposed to the heat source. |   |

## Packaging and Labeling Plan

Bivar Orca R series Super Flux LEDs are packaged in tubes, each of which contains 60 LEDs; and each tube contains a rubber stopper at each end.

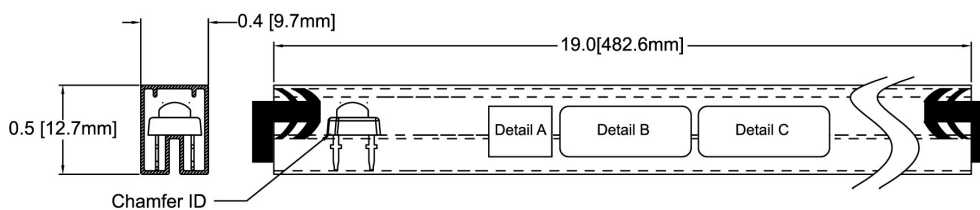

**Note: 60 pcs Max./Antistatic Tube**



Detail A

|               |                   |
|---------------|-------------------|
| BIVAR INC.    |                   |
| PO No.:XXXXXX | PN: RXXXXX-X-XXXX |

Detail B

|               |             |                 |
|---------------|-------------|-----------------|
| BIN: XXXX     | VF: X.X-X.X | QYT: 60 PCS     |
| XXXX-XXXX mcd | XXX-XXX nm  | DATE:XXXX/XX/XX |

Detail C

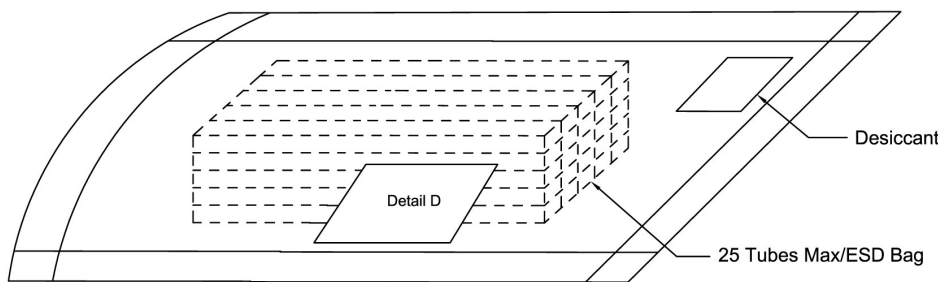

**Note: 1500 pcs Max/ESD bag**

|                                 |  |
|---------------------------------|--|
| <b>Bivar, Inc.</b> MSL 1        |  |
| 4 Thomas, Irvine, CA 92618-2593 |  |
| LOT: XXX.XXXXX.XX               |  |
|                                 |  |
| Part: <b>RXXXXX-X-XXXX</b>      |  |
| Quantity: <b>1.5</b>            |  |

Detail D

Bivar reserves the right to make changes at any time.

# Mouser Electronics

Authorized Distributor

Click to View Pricing, Inventory, Delivery & Lifecycle Information:

[BIVAR:](#)

[R20WHT-5-0080](#)