

GENERAL DESCRIPTION

This document describes the specifications for the IDTF1150 Zero-Distortion™ RF to IF Downconverting Mixer. This device is part of a series of downconverting mixers offered with high side or low side injection options for all UTRA bands. See the Part# Matrix for the details of all devices in this series.

The F1150 dual channel device is designed to operate with a single 5V supply. It is optimized for operation in a Multi-mode, Multi-carrier BaseStation Receiver for RF bands from 1700 - 2200 MHz with High Side Injection. IF frequencies from 50 to 450 MHz are supported. Nominally, the device offers +40 dBm Output IP3 with 335 mA of I_{CC}. Alternately one can adjust 4 resistor values and a toggle pin to run the device in low current mode with +36 dBm Output IP3 and 235 mA of I_{CC}.

COMPETITIVE ADVANTAGE

In typical basestation receivers the RF to IF mixer dominates the linearity performance for the entire receive system. Zero-Distortion mixers dramatically improve the maximum signal levels (IM₃ tones) that the BTS can withstand at a desired Signal to Noise Ratio (SNR.) Alternately, one can run the device in Low Current Mode to reduce Power consumption significantly. IDT's innovative design allows realization of either benefit.

- ✓ IP₃₀: ↑ **5 dB** STD Mode, ↑ **2 dB** LC Mode
- ✓ Dissipation: ↓ **40%** LC Mode, ↓ **12%** STD Mode
- ✓ Allows for higher RF gain improving **Sensitivity**



FEATURES

- Dual Path for Diversity Systems
- Ideal for Multi-Carrier Systems
- 8.5 dB Gain (200 MHz IF)
- Ultra linear +38 dBm IP₃₀ (350 MHz IF)
- Ultra linear **+40 dBm IP₃₀ (200 MHz IF)**
- Low NF < 10 dB
- 200 Ω output impedance
- Ultra high +13 dBm P1dB_I
- **Pin Compatible** with existing solutions
- 6x6 36 pin package
- **Power Down mode**
- < 200 nsec settling from Power Down
- Minimizes Synth pulling in Standby Mode
- Low Current Mode : **I_{CC} = 235 mA**
- Standard Mode: I_{CC} = 335 mA

DEVICE BLOCK DIAGRAM

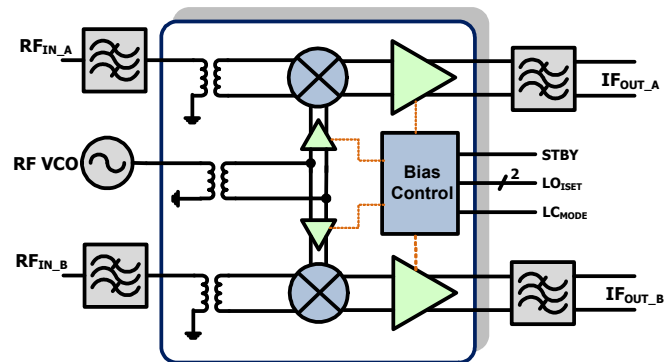

PART# MATRIX

Part#	RF freq range	UTRA bands	IF freq range	Typ. Gain	Injection
F1100	698 - 915	5,6,8,12,13,14,17,19,20	50 - 450	8.5	High Side
F1102	698 - 915	5,6,8,12,13,14,17,19,20	50 - 250	8.5	Both
F1150	1700 - 2200	1,2,3,4,9,10, 33, 34,35, 36, 37,39	50 - 450	8.5	High Side
F1152	1400 - 2200	1,2,3,4,9,10,11,21 ¹ , 24 ¹ , 33, 34,35, 36, 37,39	50 - 350	8.4	Low Side
F1162	2200 - 2700	7,38,40,41 ²	50 - 500	8.9	Both

1 - with High side injection
2 - With High side or Low side injection

ORDERING INFORMATION

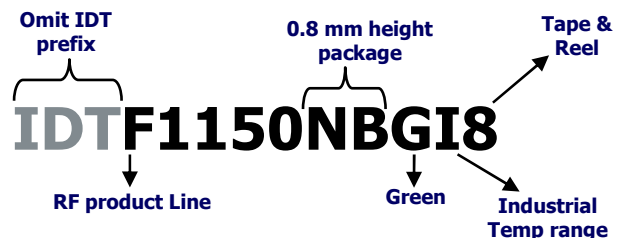

ABSOLUTE MAXIMUM RATINGS

VCC to GND	-0.3V to +5.5V
STBY, LC _{MODE}	-0.3V to (VCC ₋ + 0.3V)
IF_A+, IF_B+, IF_A-, IF_B-, LO_IN	-0.3V to (VCC ₋ + 0.3V)
LO1_ADJ, LO2_ADJ, IF_BiasA, IF_BiasB to GND	-0.3V to +1.2V
RF Input Power (RF_IN[A+, A-, B+, B-])	+20dBm
Continuous Power Dissipation	2.2W
θ_{JA} (Junction – Ambient)	+35°C/W
θ_{JC} (Junction – Case) The Case is defined as the exposed paddle	+2.1°C/W
Operating Temperature Range (Case Temperature)	T _C = -40°C to +100°C
Maximum Junction Temperature	150°C
Storage Temperature Range	-65°C to +150°C
Lead Temperature (soldering, 10s) .	+260°C

Stresses above those listed above may cause permanent damage to the device. Functional operation of the device at these or any other conditions above those indicated in the operational section of this specification is not implied. Exposure to absolute maximum rating conditions for extended periods may affect device reliability.

RF to IF Dual Downconverting Mixer
1700 - 2200 MHz F1150NBGI
IDTF1150 SPECIFICATION (1700 – 2200 MHz MIXER w/HIGH SIDE INJECTION)

Specifications apply at $V_{CC} = +5.0V$, $F_{RF} = 1850 \text{ MHz}$, $F_{IF} = 350\text{MHz}$, $P_{LO} = 0 \text{ dBm}$, $T_C = +25^\circ\text{C}$, $STBY = GND$, $LC_{MODE} = V_{IH}$ (STD Mode), EVKit BOM = Standard Mode, Transformer Loss included (not de-embedded) unless otherwise noted.

Parameter	Comment	Symbol	min	typ	max	units
Logic Input High	For Standby, LC_{MODE} Pins	V_{IH}	2			V
Logic Input Low	For Standby, LC_{MODE} Pins	V_{IL}			0.8	V
Logic Current	For Standby, LC_{MODE} Pins	I_{IH}, I_{IL}	-30		+30	μA
Supply Voltage(s)	All V_{CC} pins	V_{CC}		4.75 to 5.25		V
Operating Temperature Range	Case Temperature	T_{CASE}		-40 to +100		degC
Supply Current	Total V_{CC} , STD Mode ▪ Total Both Channels	I_{STD}		334	375	mA
Supply Current	Total V_{CC} , LC Mode ▪ $LC_{MODE} = GND$ ▪ EVkit BOM = LC Mode ▪ Total Both Channels	I_{LC}		235	260	mA
Supply Current	Standby Mode ▪ $STBY = V_{IH}$ ▪ Total Both Channels	I_{STBY}		23	30	mA
RF Freq Range	Operating Range	F_{RF}		1700 to 2200		MHz
IF Freq Range	Operating Range	F_{IF}		50 to 450		MHz
LO Freq Range	High Side Injection	F_{LO}		1750 to 2650		MHz
LO Power		P_{LO}		-3 to +6		dBm
RF Input Impedance	Single Ended <i>Return Loss ~17 dB</i>	Z_{RF}		50		Ω
IF Output Impedance	Differential <i>Return Loss ~ 13 dB</i>	Z_{IF}		200		Ω
LO port Impedance	Single Ended <i>Return Loss ~15 dB</i>	Z_{LO}		50		Ω
Settling Time	<ul style="list-style-type: none"> Pin = -13 dBm Gate STBY from V_{IH} to V_{IL} Time for IF Signal to settle to within 0.1 dB of final value 	T_{SETT}		0.155		μsec
Gain STD Mode	Conversion Gain <ul style="list-style-type: none"> $F_{RF} = 1710 \text{ MHz}$ $LC_{MODE} = V_{IH}$ EVkit BOM = STD Mode $F_{IF} = 350 \text{ MHz}$ 	G_{STD}	7.0	8.1	8.6	dB
Gain LC Mode	Conversion Gain <ul style="list-style-type: none"> $F_{RF} = 2050 \text{ MHz}$ $LC_{MODE} = GND$ EVkit BOM = LC Mode $F_{IF} = 200 \text{ MHz}$ 	G_{LC}	7.2	8.2	8.8	dB
NF STD Mode	Noise Figure	NF_{STD}		10		dB

IDTF1150 SPECIFICATION (CONTINUED)

Parameter	Comment	Symbol	min	typ	max	units
NF LC Mode	Noise Figure <ul style="list-style-type: none"> LC_{MODE} = GND EVKit BOM = LC Mode F_{IF} = 200 MHz 	NF _{LC}		9.6		dB
NF w/Blocker	<ul style="list-style-type: none"> -100 MHz offset blocker P_{IN} = +4 dBm F_{IF} = 250 MHz 	NF _{BLK}		17.5		dB
Output IP3 – Narrowband	<ul style="list-style-type: none"> P_{IN} = -10 dBm per tone 800 KHz Tone Separation 	IP3 _{O1}	36	38		dBm
Output IP3 – Wideband	<ul style="list-style-type: none"> P_{IN} = -10 dBm per tone 30 MHz Tone Separation 	IP3 _{O2}		37		dBm
Output IP3 – LC _{MODE}	<ul style="list-style-type: none"> P_{IN} = -5 dBm per tone F_{RF} = 1850 MHz F_{IF} = 200 MHz 800 KHz Tone Separation LC_{MODE} = GND EVKit BOM = LC Mode 	IP3 _{O3}	33	36		dBm
2RF – 2LO rejection	<ul style="list-style-type: none"> P_{RF} = -10 dBm Frequency = F_{RF} + ½ F_{IF} 	2x2		-74	-64	dBc
1 dB Compression	<ul style="list-style-type: none"> Input referred 	P1dB _{I1}	12	12.8		dBm
1 dB Compression - LC _{MODE}	<ul style="list-style-type: none"> Input referred LC_{MODE} = GND EVKit BOM = LC Mode F_{IF} = 200 MHz 	P1dB _{I2}	8	10.6		dBm
Gain Comp. w/blocker	<ul style="list-style-type: none"> Blocker → unmodulated tone P_{IN} = +8 dBm, -100 MHz offset Signal Pin Tone = -20 dBm Measure ΔG of signal F_{IF} = 250 MHz 	ΔG _{AC}		0.15		dB
Channel Isolation	IF_B Pout vs. IF_A w/ RF_A input	ISO _C		52		dB
LO to IF leakage		ISO _{LI}		-39	-35	dBm
RF to IF leakage	P _{in} = -10 dBm	ISO _{RI}		-30	-22.5	dBm
LO to RF leakage		ISO _{LR}		-40		dBm

1 – Items in min/max columns in ***bold italics*** are Guaranteed by Test

2 – All other Items in min/max columns are Guaranteed by Design Characterization

TYPICAL OPERATING CONDITIONS

Unless otherwise Noted, the following Apply

- High Side Injection, 350 MHz IF & 200 MHz IF
- RF frequency = 1850 MHz for single point measurements
- Average of Channel A & Channel B
- Pin = -10 dBm, 800KHz Tone Spacing
- Use the Decoder example below for the Typ Op graphs on pages 6 – 10 & 13 - 17

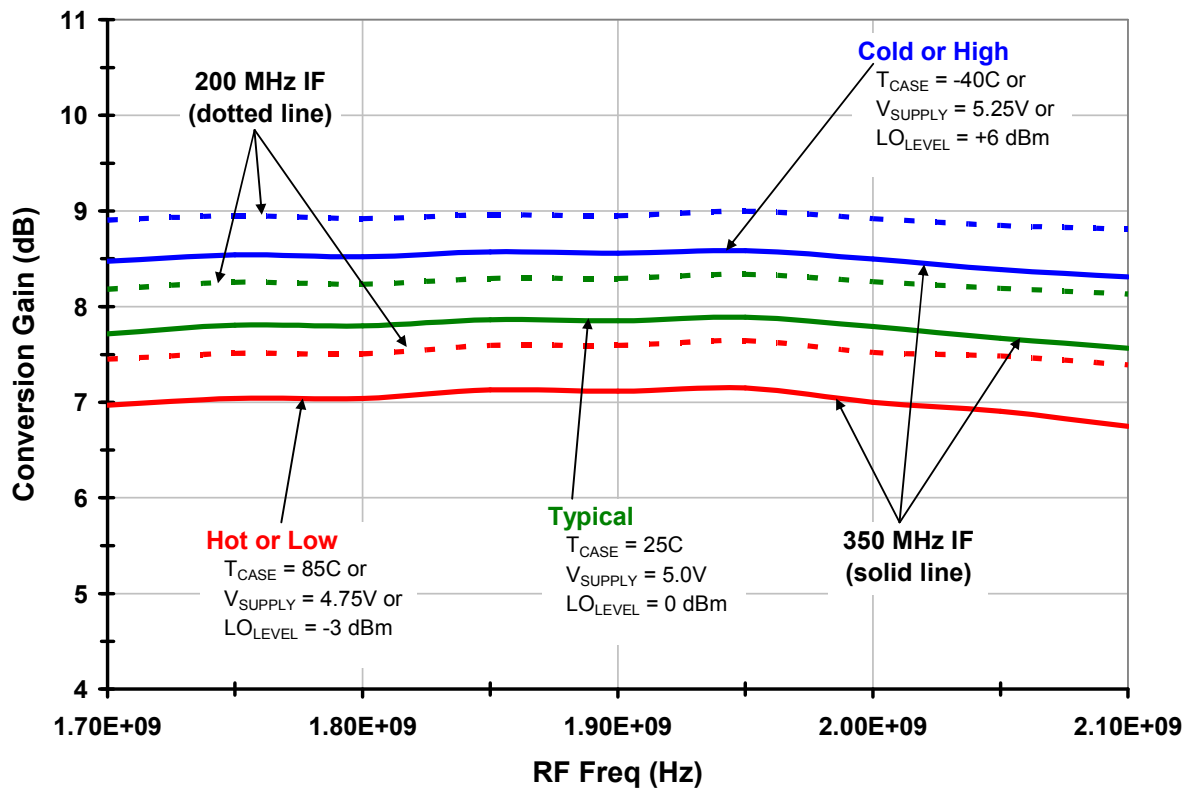

TYPICAL OPERATING CONDITIONS STD MODE (1) — SEE TRACE DECODER ON PAGE 5

Gain vs. Temperature

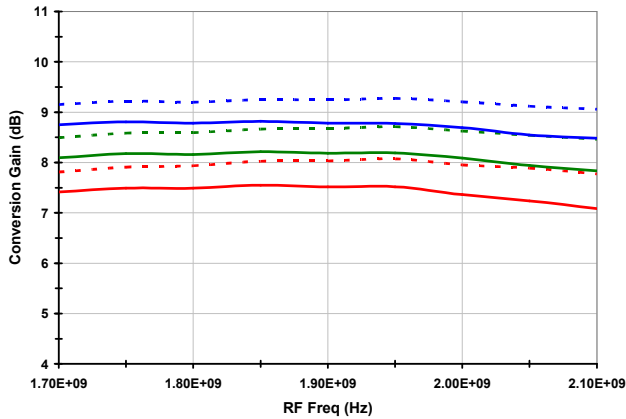

Gain vs. V_{CC}

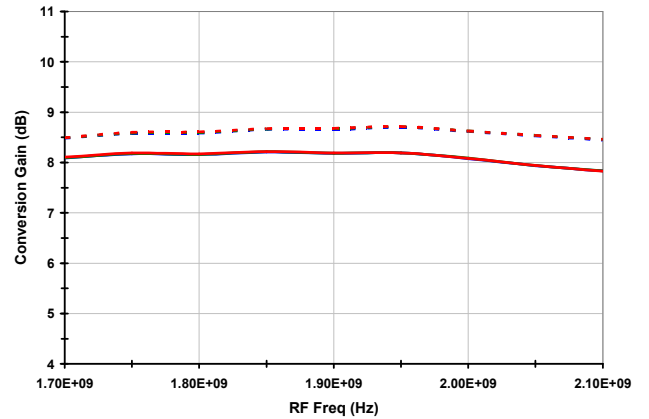

Gain vs. LO Level

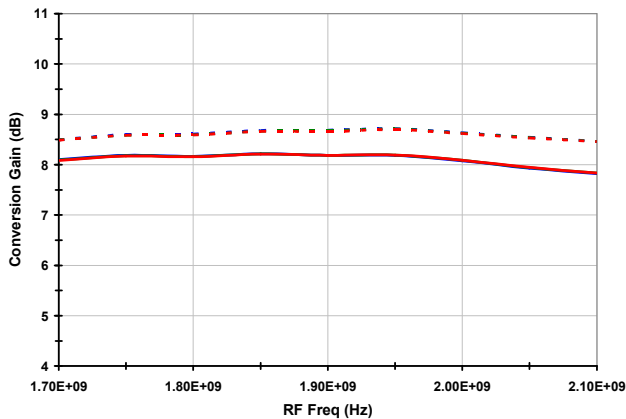

Output IP3 vs. Temperature

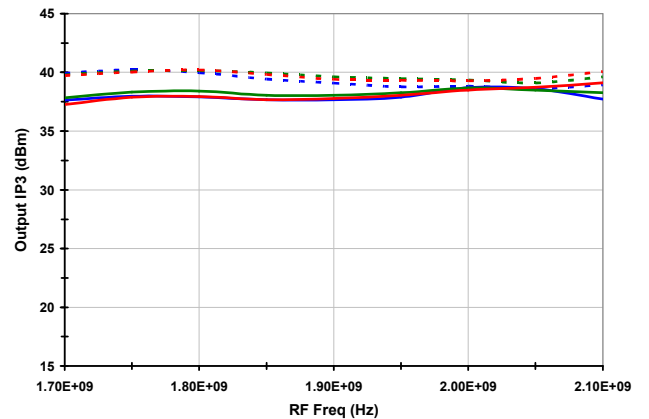

Output IP3 vs. V_{CC}

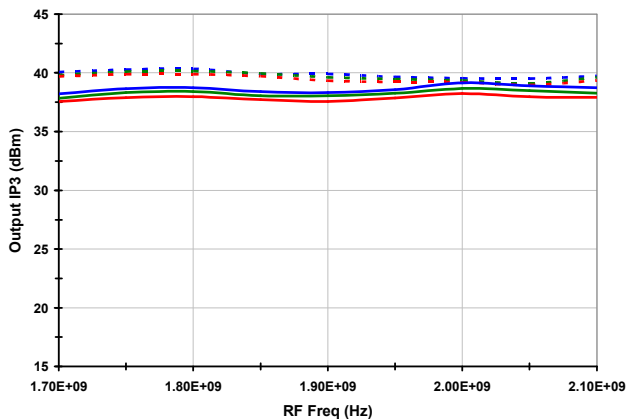

Output IP3 vs. LO Level

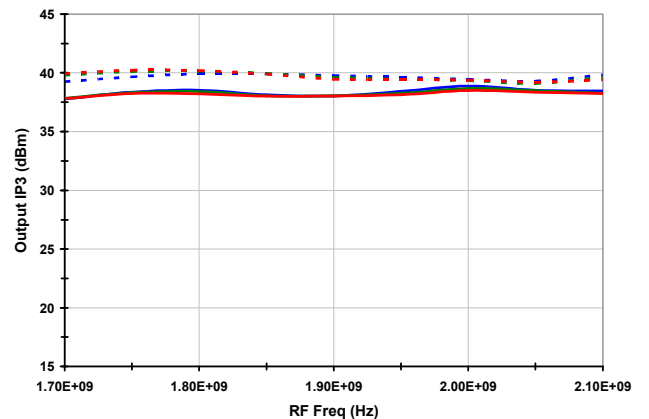

TYPICAL OPERATING CONDITIONS STD MODE (2) - SEE TRACE DECODER ON PAGE 5

P1dB vs. Temperature

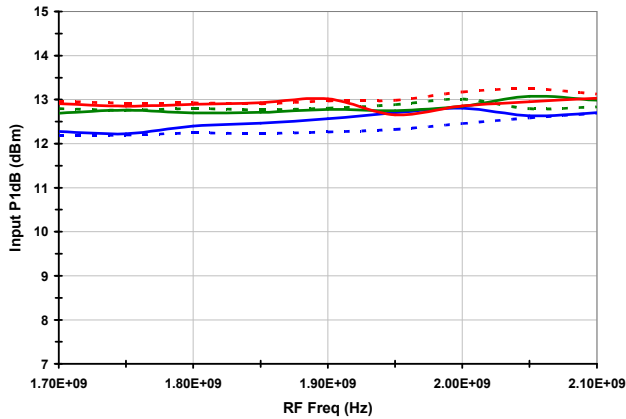

P1dB vs. V_{CC}

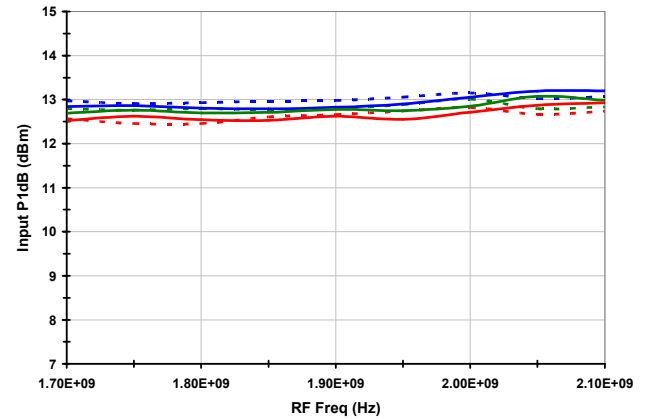

P1dB vs. LO Level

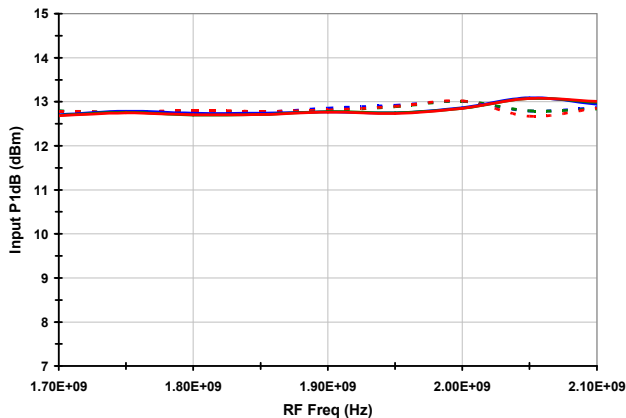

2RF x 2LO rejection vs. Temperature

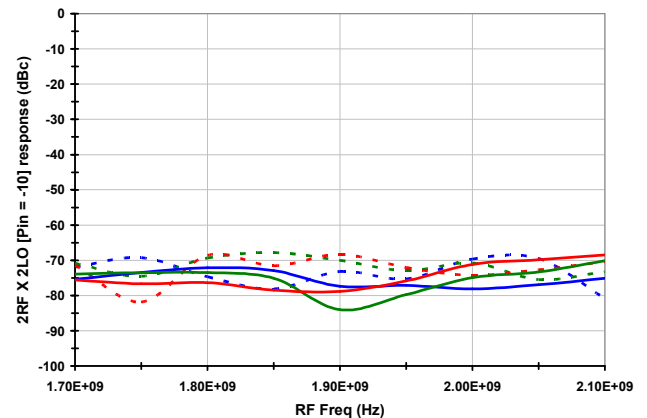

2RF x 2LO Rejection vs. V_{CC}

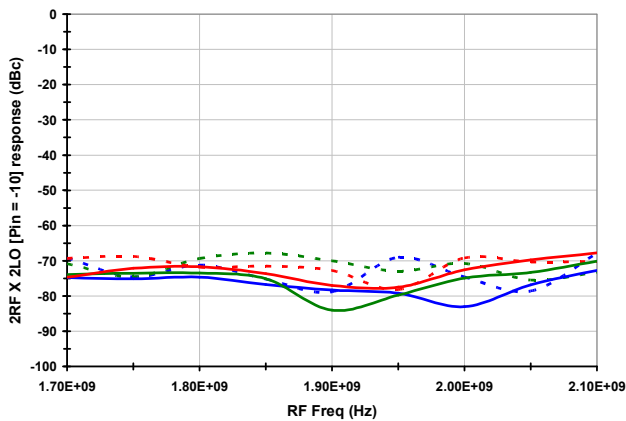

2RF x 2LO rejection vs. LO Level

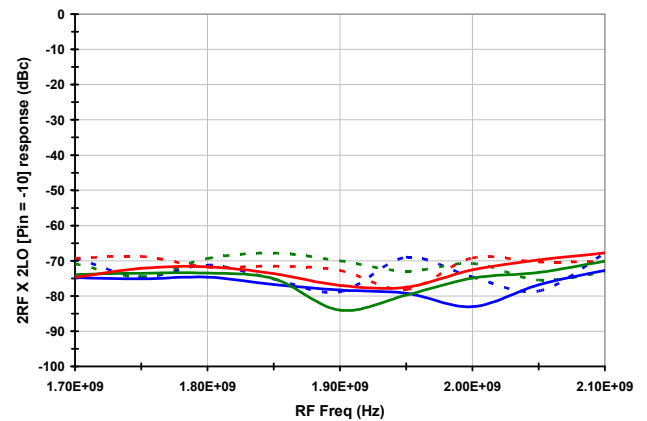

TYPICAL OPERATING CONDITIONS STD MODE (3) – SEE TRACE DECODER ON PAGE 5

I_{CC} vs. Temperature

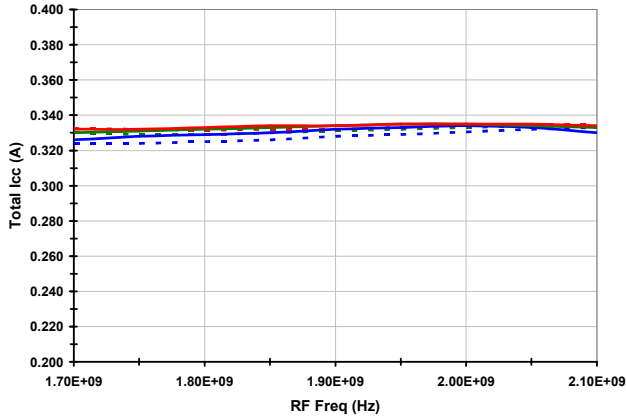

I_{CC} vs. V_{CC}

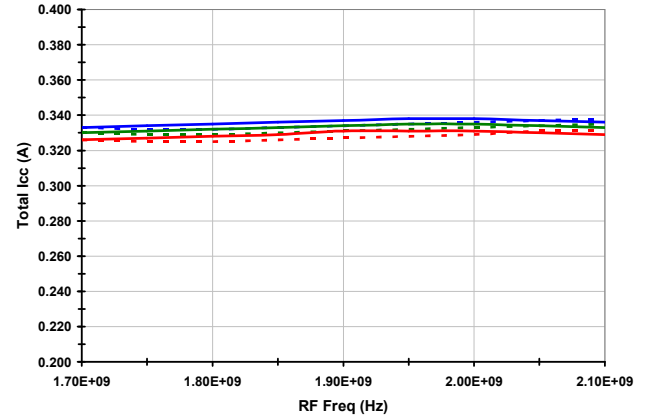

I_{CC} vs. LO Level

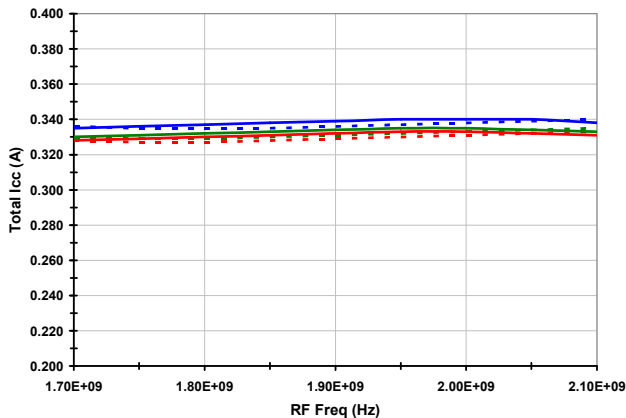

LO-IF Leakage vs. Temperature

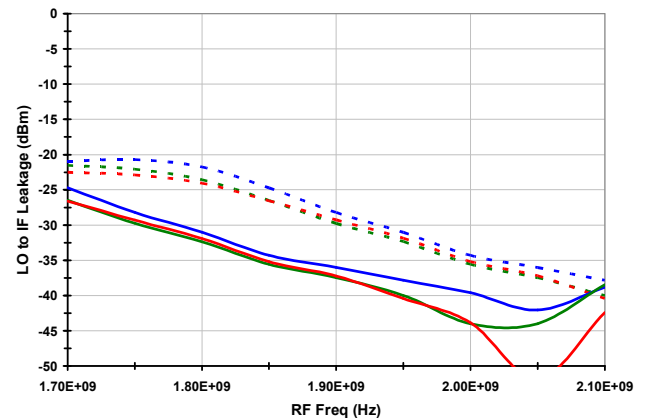

LO-IF Leakage vs. V_{CC}

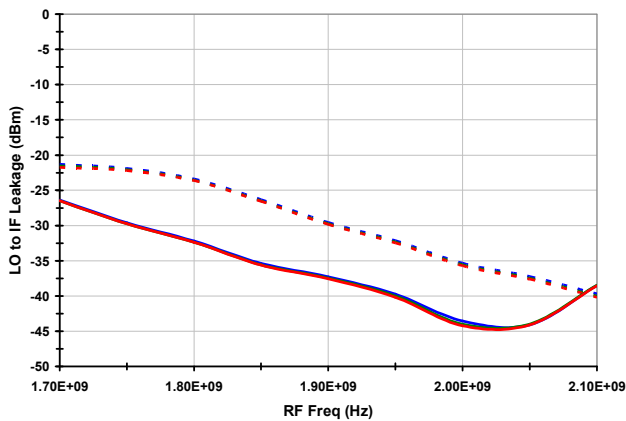

LO-IF Leakage vs. LO Level

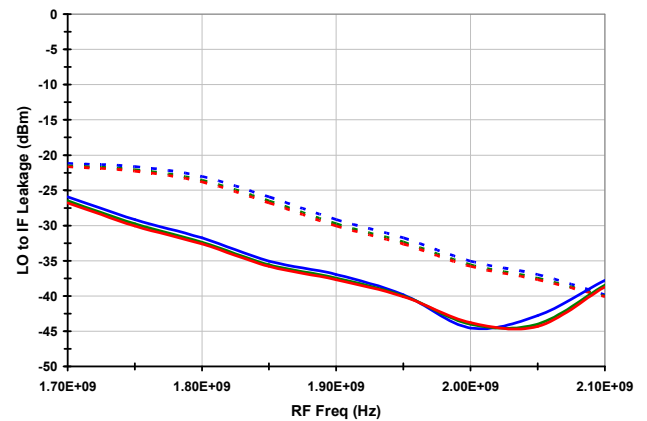

TYPICAL OPERATING CONDITIONS STD MODE (4) – SEE TRACE DECODER ON PAGE 5

RF-IF Leakage vs. Temperature

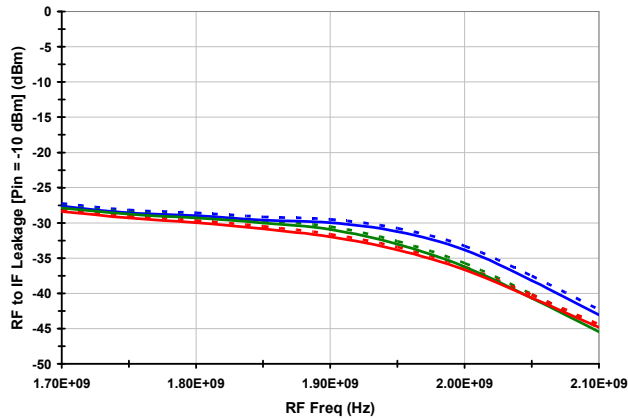

RF-IF Leakage vs. V_{CC}

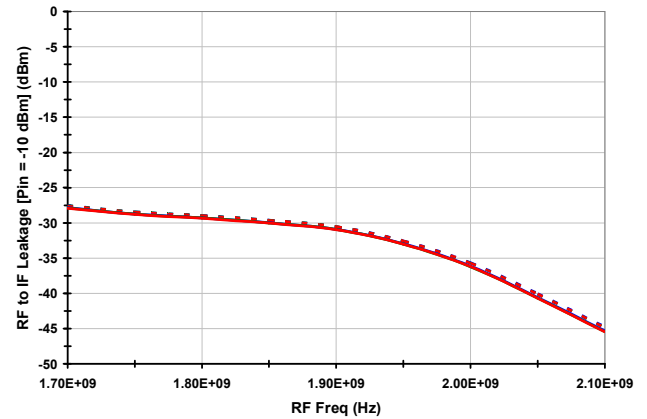

RF-IF Leakage vs. LO Level

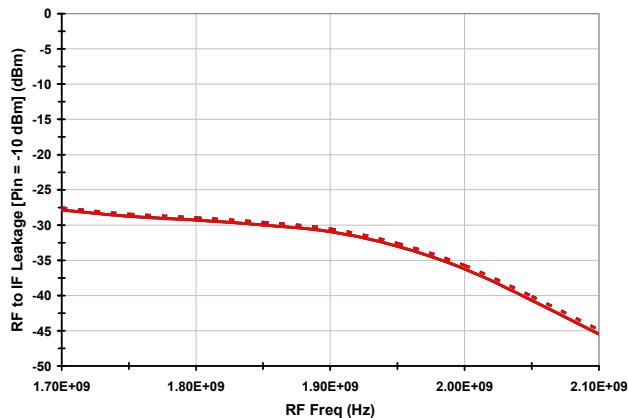

3RF X 3LO Rejection vs. Temperature

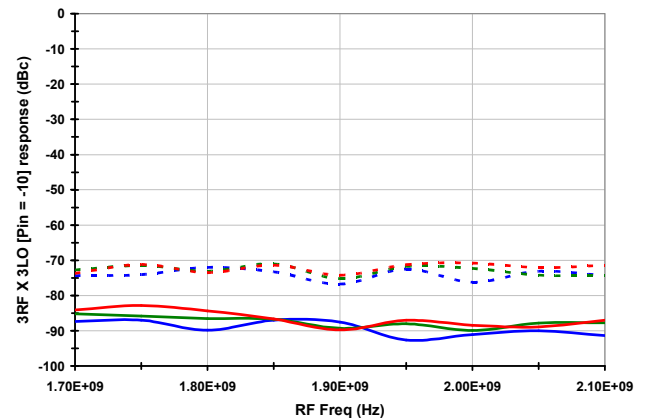

3RF X 3LO Rejection vs. V_{CC}

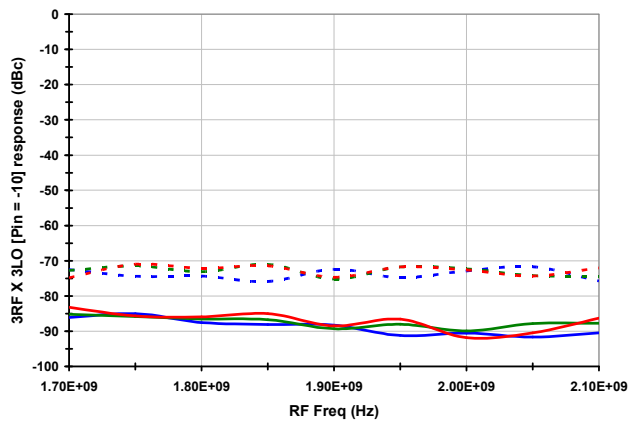

3RF X 3LO Rejection vs. LO Level

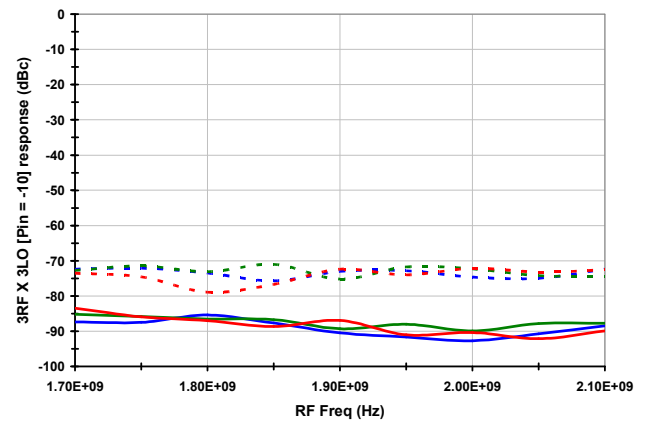

TYPICAL OPERATING CONDITIONS STD MODE (5) – SEE TRACE DECODER ON PAGE 5

Channel Isolation vs. Temperature

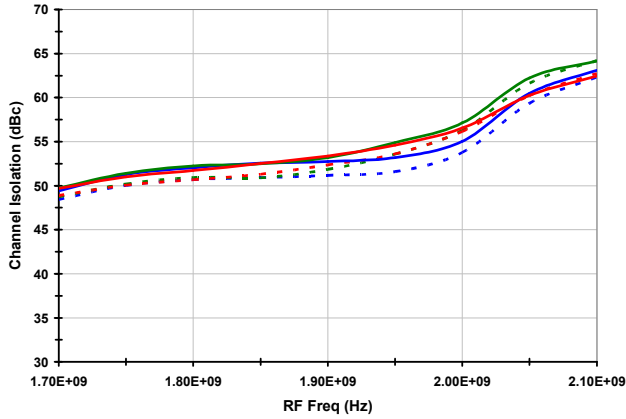

Channel Isolation vs. V_{CC}

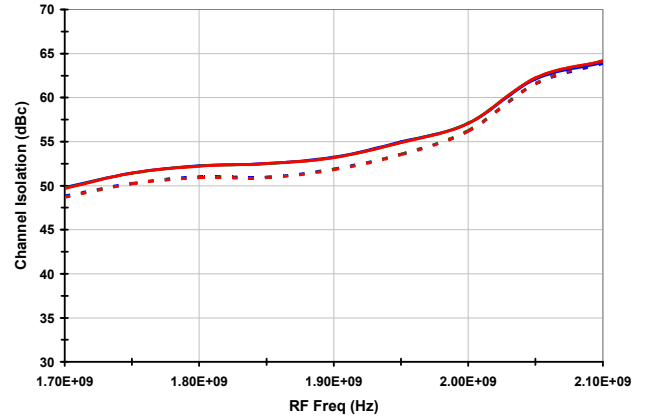

Channel Isolation vs. LO Level

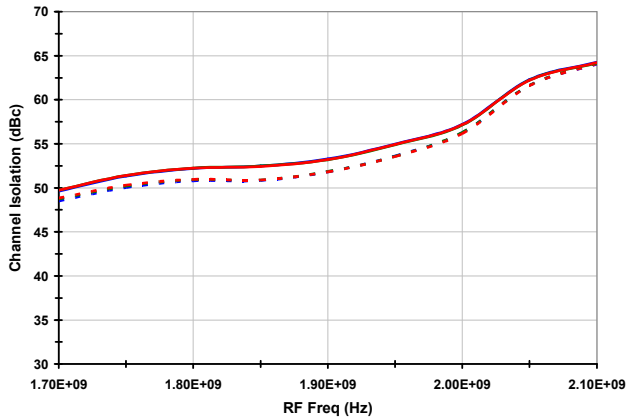

Noise Figure vs. Temperature



Noise Figure vs. V_{CC}

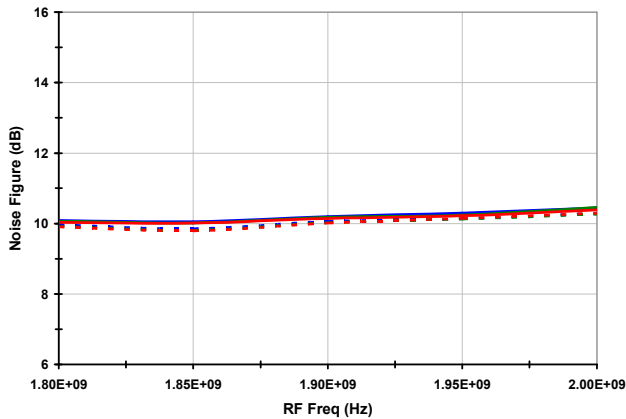

Noise Figure ChA vs. ChB

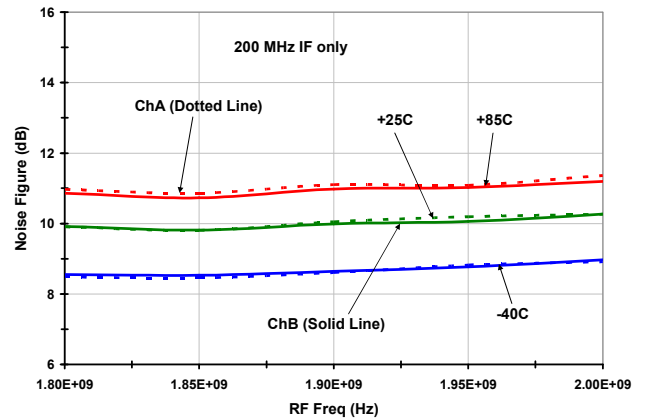

TYPICAL OPERATING CONDITIONS – GENERAL (-1-)

NF v. Blocker (RF = 1850 MHz, IF = 250 MHz, T_A = 25C)

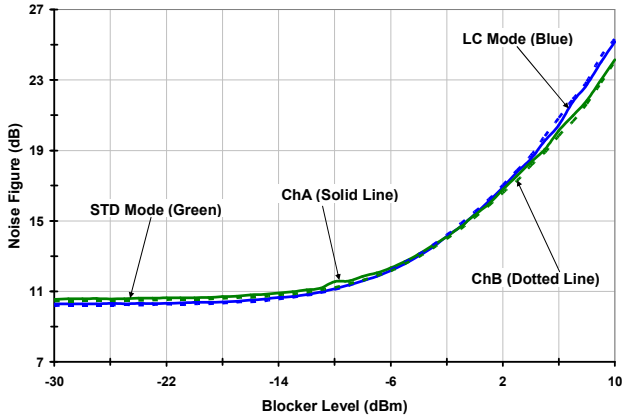

5x-4 Spur (+5 dBm Pin, IF = 350 MHz, STD Mode)

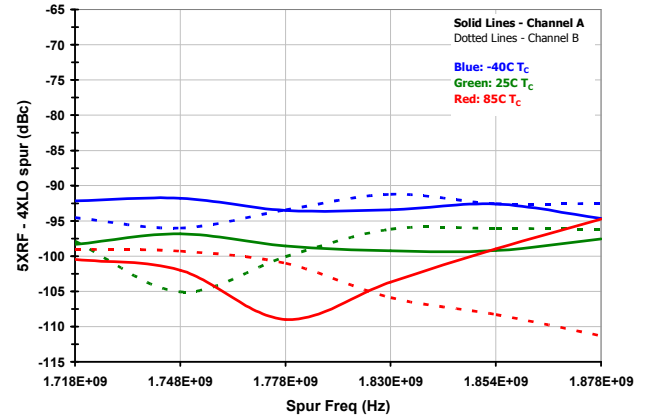

Settling Time (STBY -> V_{IL})

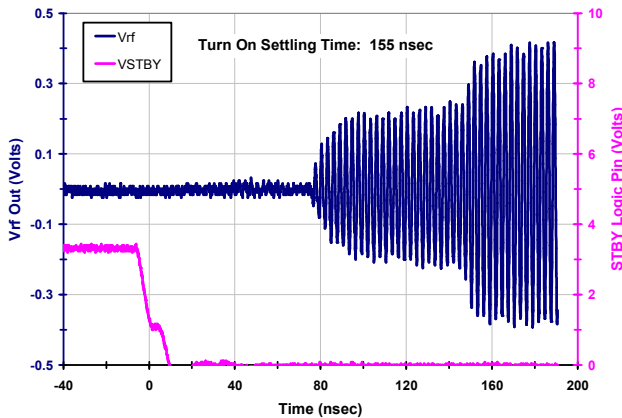

Settling Time (STBY -> V_{IH})

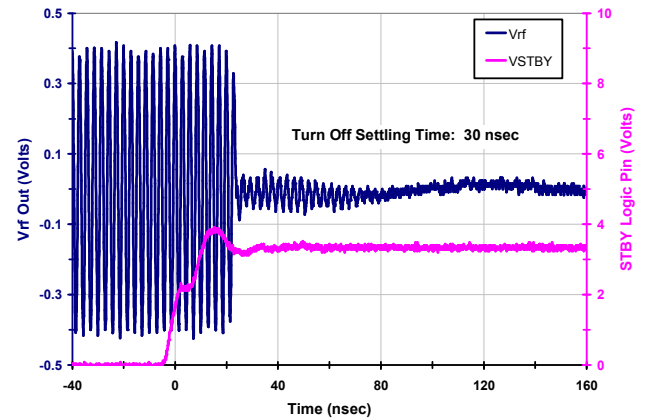

EVKit LO Port Match (T_A = 25C, P_{MEAS} = 0 dBm)

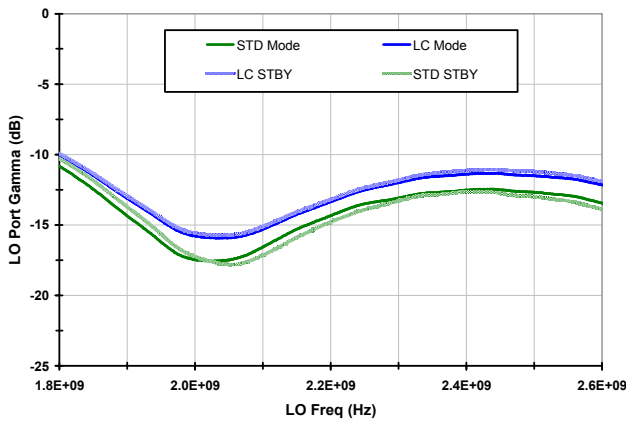

EVkit RF Port Match (T_A = 25C)

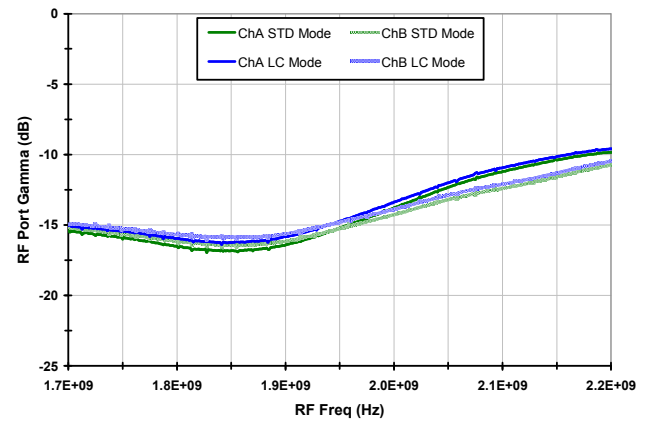

TYPICAL OPERATING CONDITIONS – GENERAL (-2-)

EVkit IF Port Match ($T_A = 25C$)

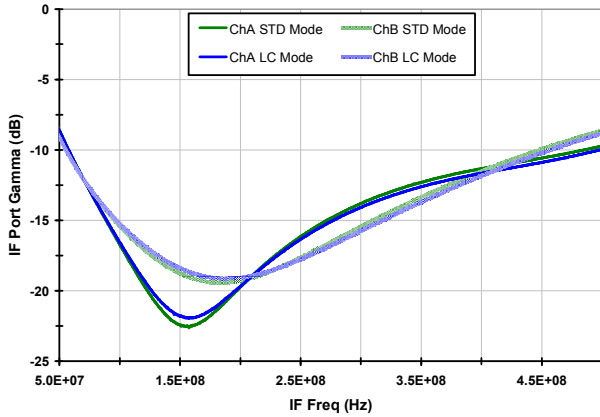

Small Signal Compression (IF = 250 MHz, STD Mode)

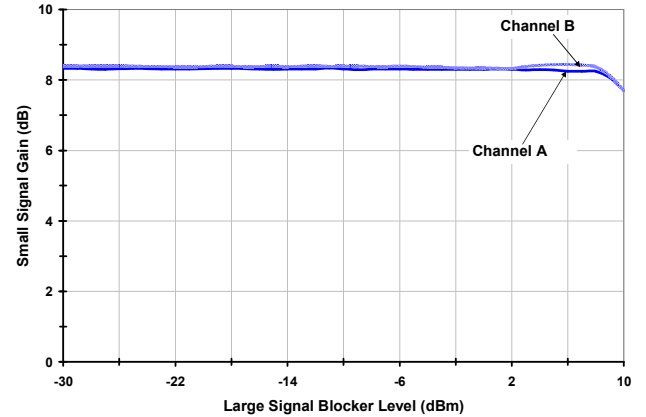

IP_{3O} vs. Tone Δf ($T_A = 25C$, Freq = 1850 MHz)

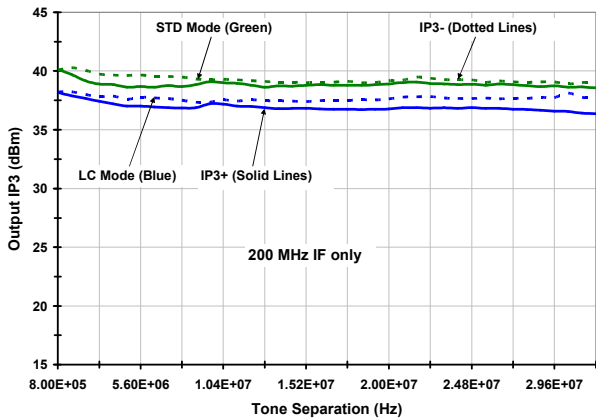

IP_{3O} vs. RF Power ($T_A = 25C$, Freq = 1850 MHz)

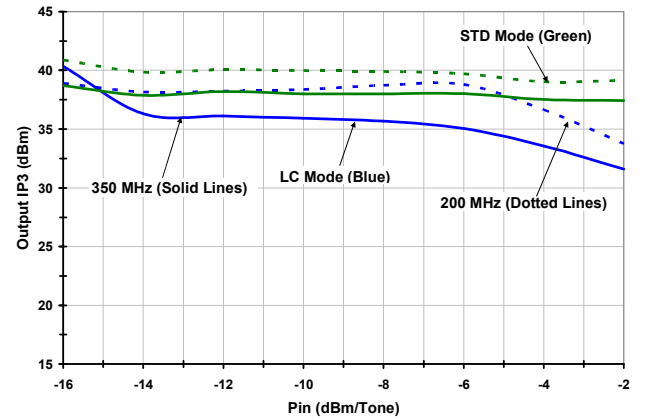

Gain Distribution (N = 2348, F_{RF} = 1710M, F_{IF} = 350M)

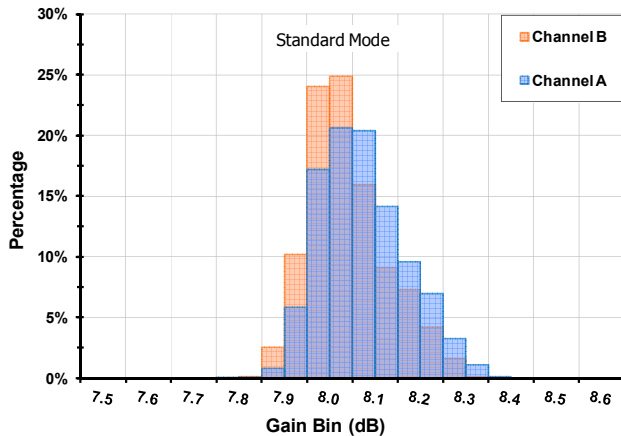

IP_{3O} Distribution (N = 2348, F_{RF} = 1850M, F_{IF} = 200M)

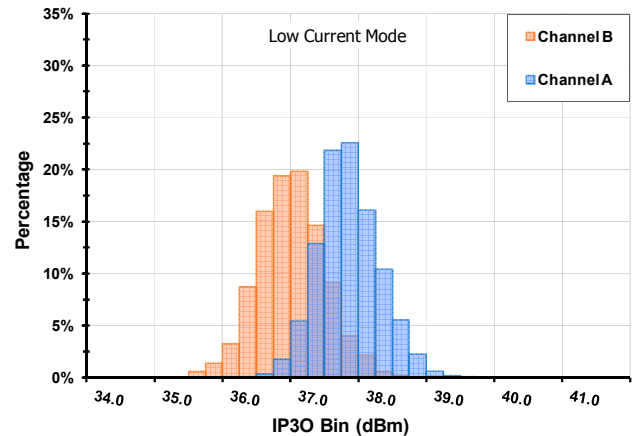

TYPICAL OPERATING CONDITIONS LC MODE (1) — SEE TRACE DECODER ON PAGE 5

Gain vs. Temperature

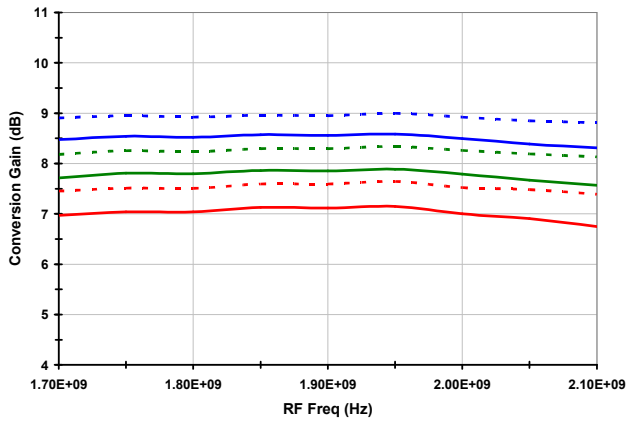

Gain vs. V_{CC}

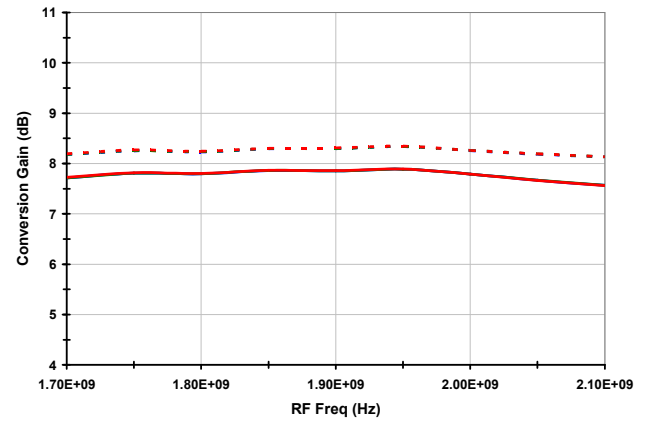

Gain vs. LO Level

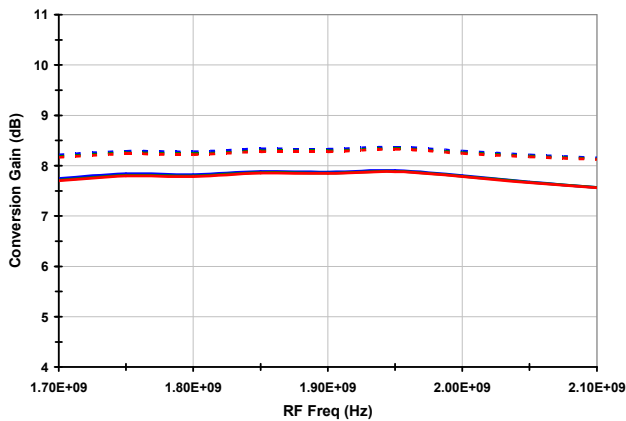

Output IP3 vs. Temperature

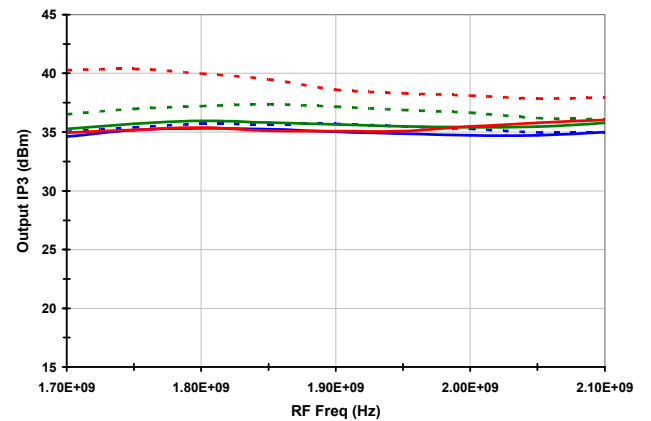

Output IP3 vs. V_{CC}

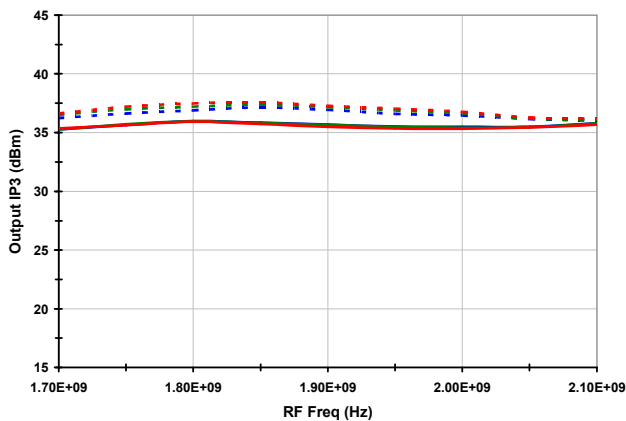

Output IP3 vs. LO Level

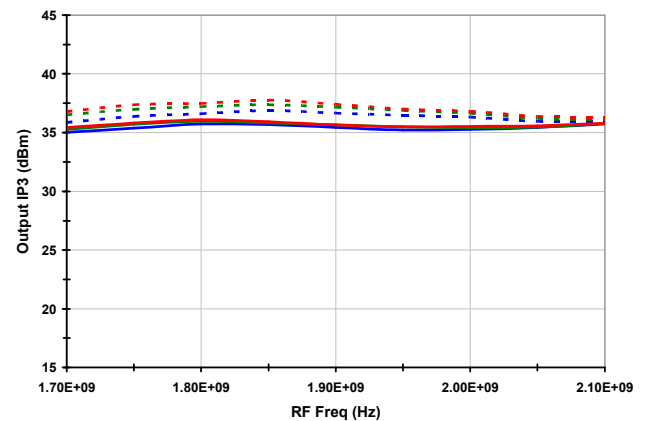

TYPICAL OPERATING CONDITIONS LC MODE (2) - SEE TRACE DECODER ON PAGE 5

P1dB vs. Temperature

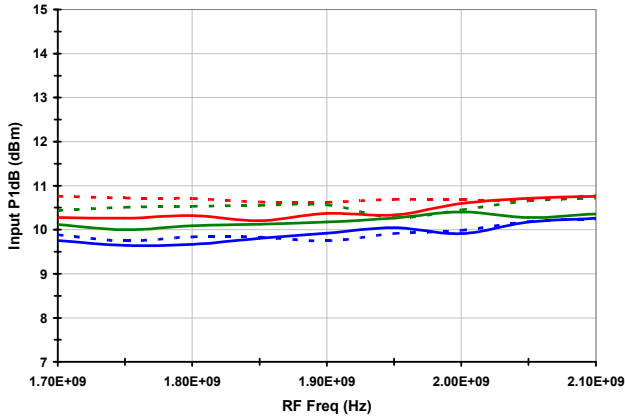

P1dB vs. V_{CC}

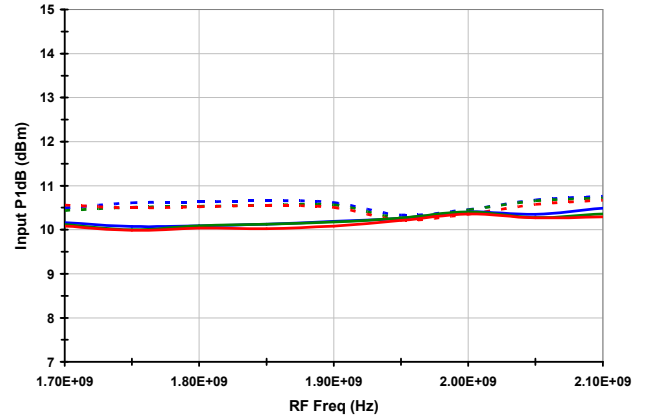

P1dB vs. LO Level

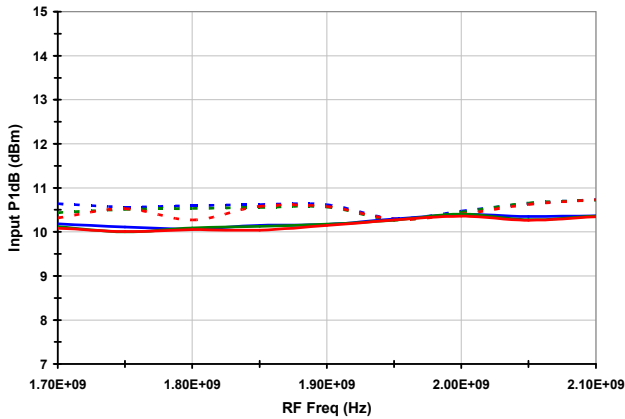

2RF x 2LO rejection vs. Temperature

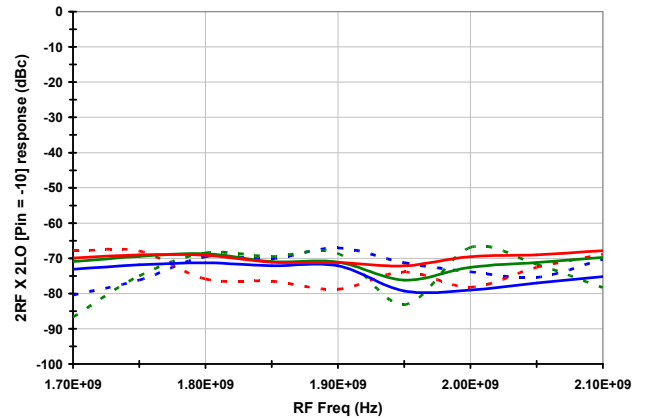

2RF x 2LO Rejection vs. V_{CC}

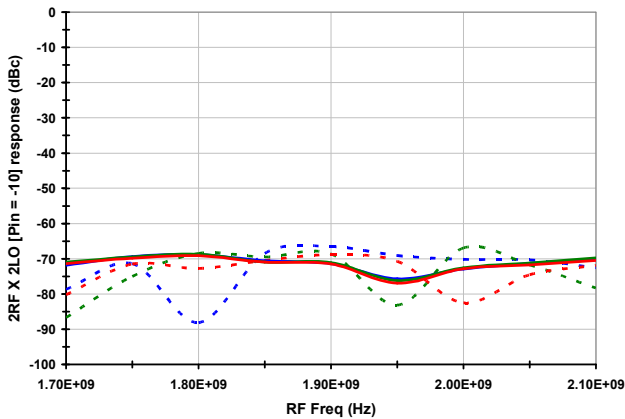

2RF x 2LO rejection vs. LO Level

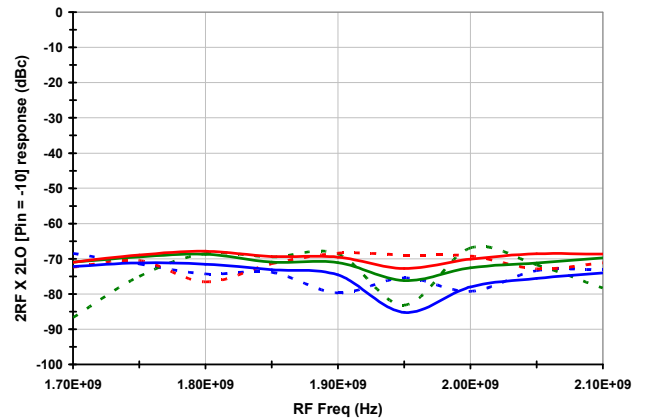

TYPICAL OPERATING CONDITIONS LC MODE (3) — SEE TRACE DECODER ON PAGE 5

I_{CC} vs. Temperature

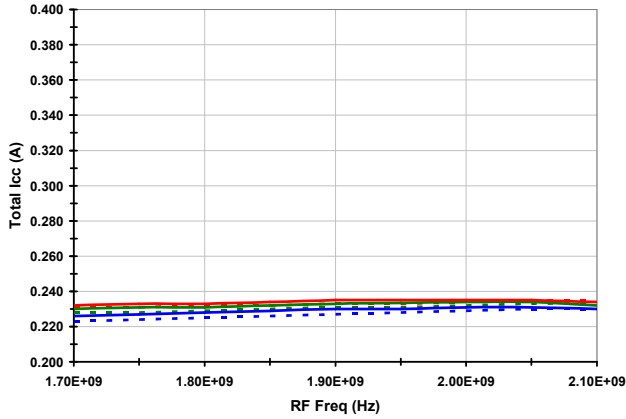

I_{CC} vs. V_{CC}

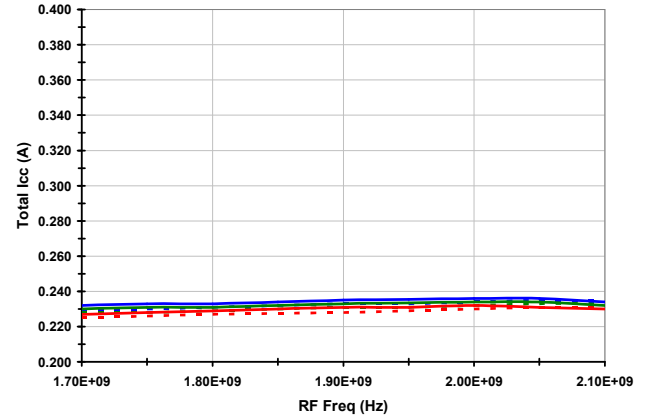

I_{CC} vs. LO Level

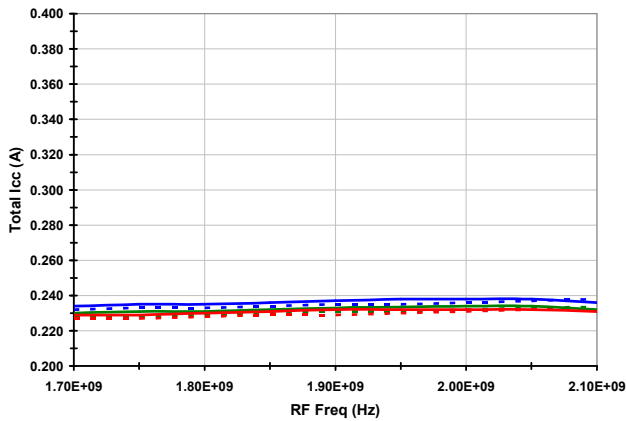

LO-IF Leakage vs. Temperature

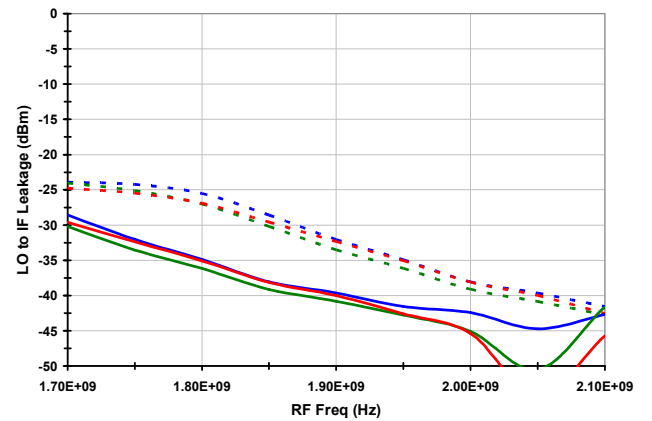

LO-IF Leakage vs. V_{CC}

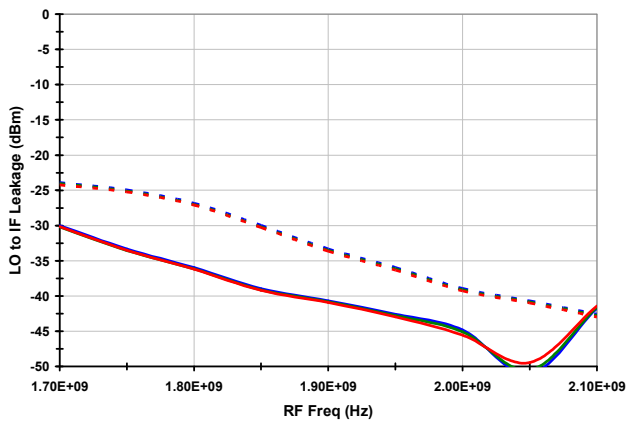

LO-IF Leakage vs. LO Level

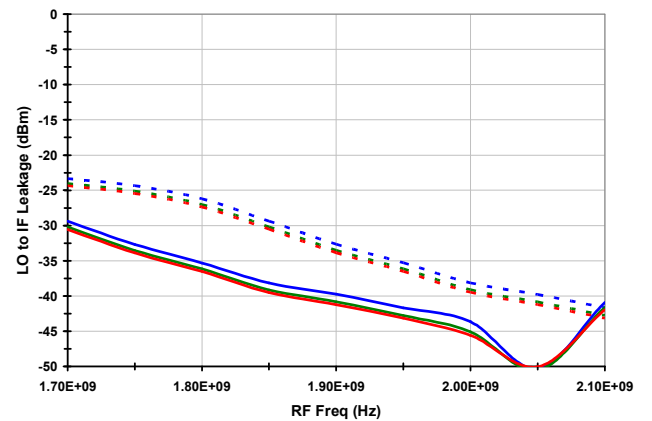

TYPICAL OPERATING CONDITIONS LC MODE (4) — SEE TRACE DECODER ON PAGE 5

RF-IF Leakage vs. Temperature

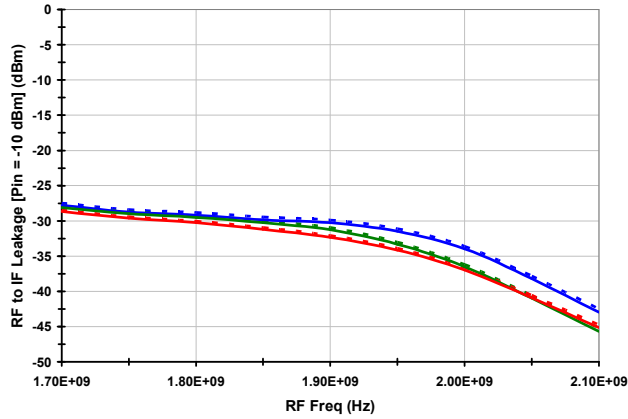

RF-IF Leakage vs. V_{CC}

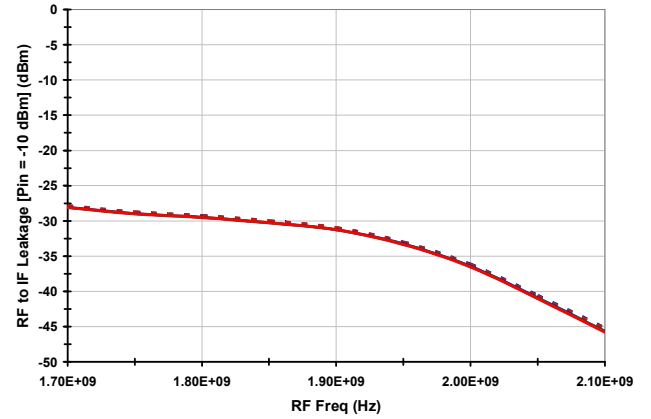

RF-IF Leakage vs. LO Level

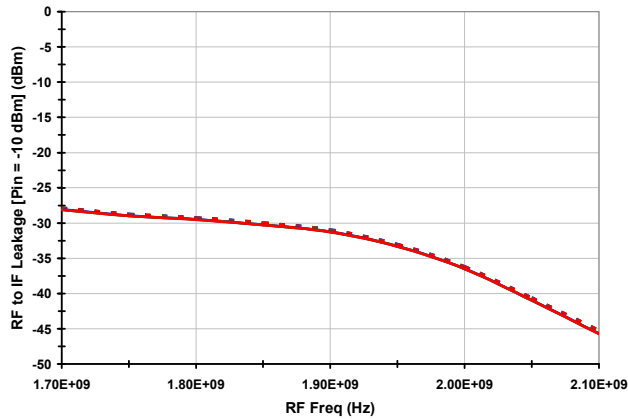

3RF X 3LO Rejection vs. Temperature

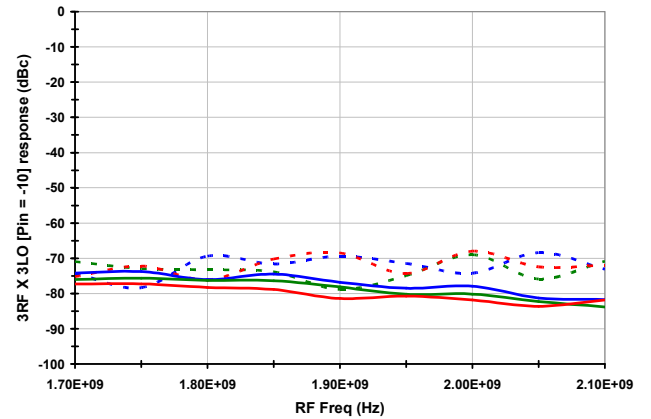

3RF X 3LO Rejection vs. V_{CC}

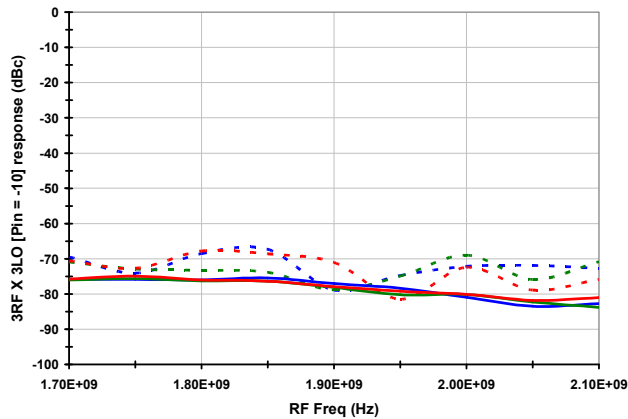

3RF X 3LO Rejection vs. LO Level

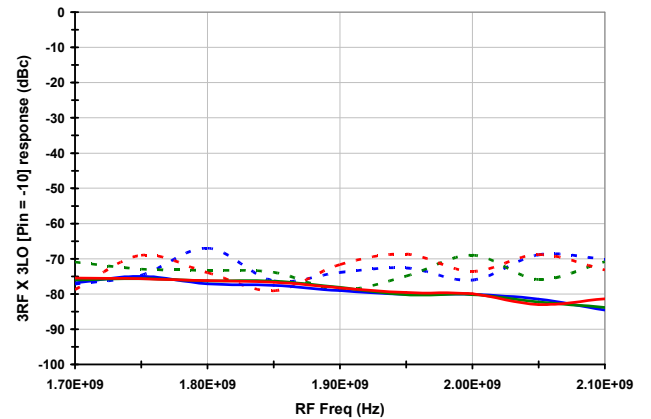

TYPICAL OPERATING CONDITIONS LC MODE (5) – SEE TRACE DECODER ON PAGE 5

Channel Isolation vs. Temperature

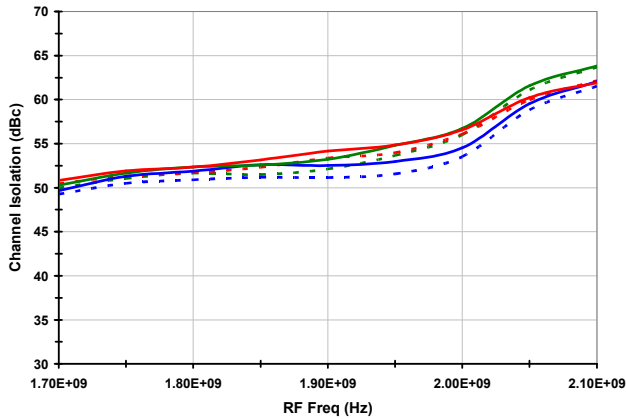

Channel Isolation vs. V_{CC}

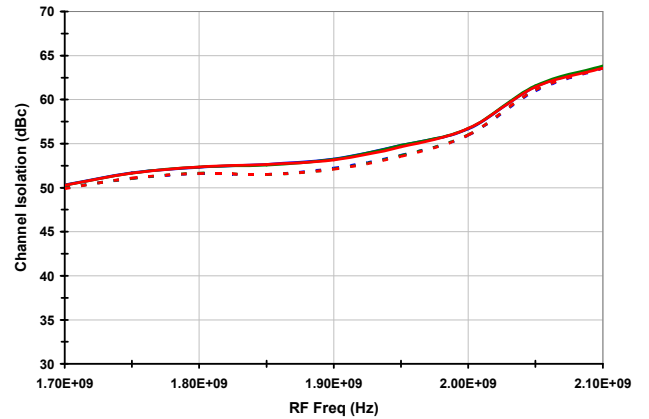

Channel Isolation vs. LO Level

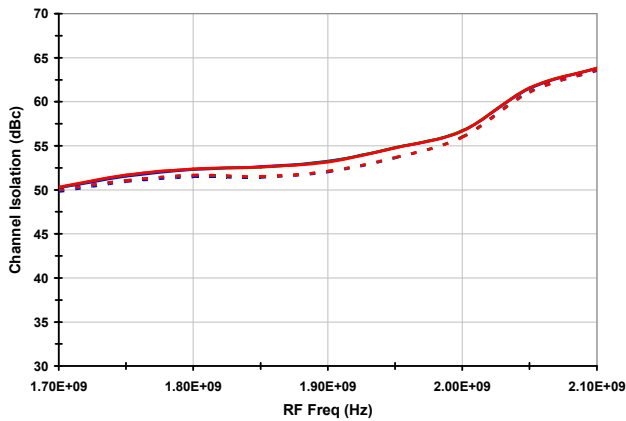

Noise Figure vs. Temperature

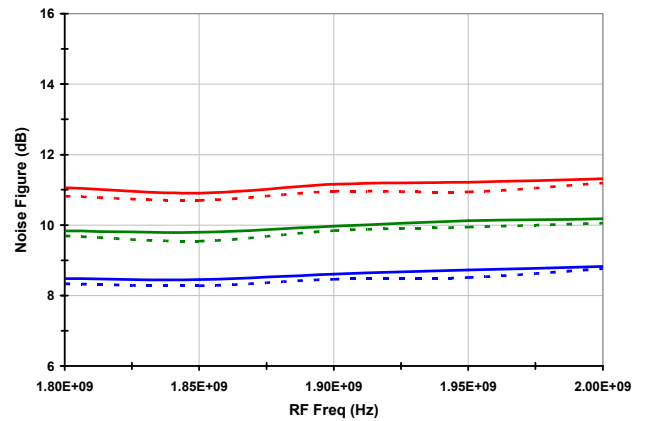

Noise Figure vs. V_{CC}

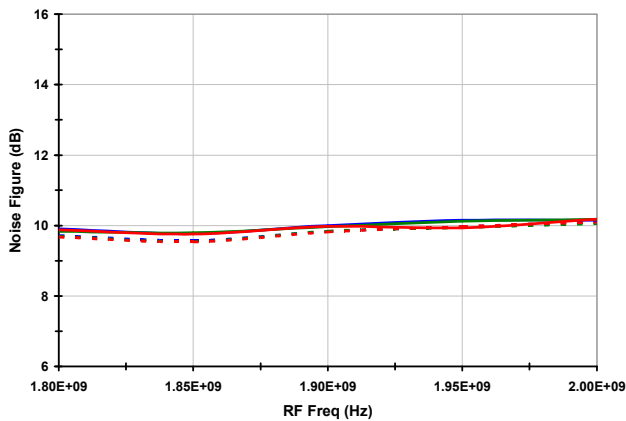

Noise Figure ChA vs. ChB

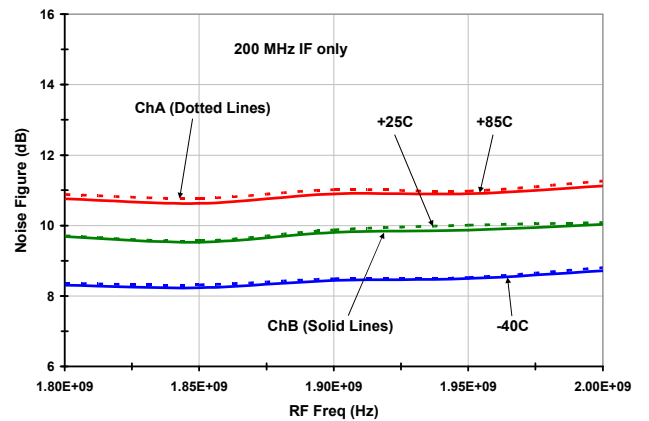

RF to IF Dual Downconverting Mixer

1700 - 2200 MHz F1150NBGI

HIGH TEMP OPERATING CONDITIONS [200 MHz IF] (1)

Gain [EVKit de-embedded]

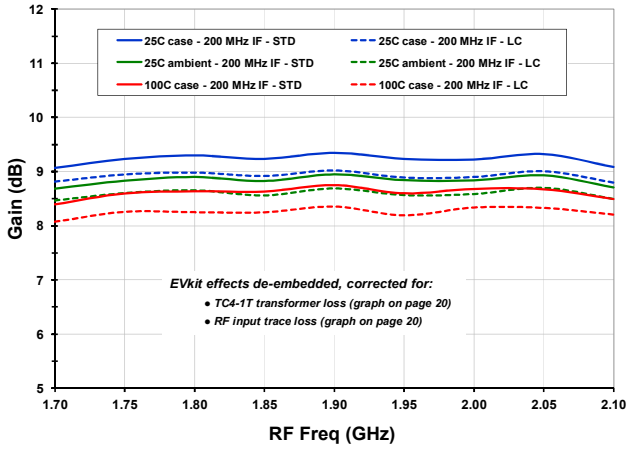

Output IP3 [EVkit de-embedded]

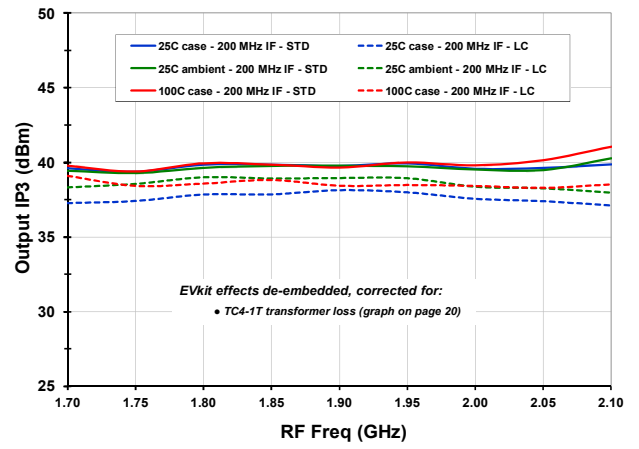

2RF x 2LO rejection

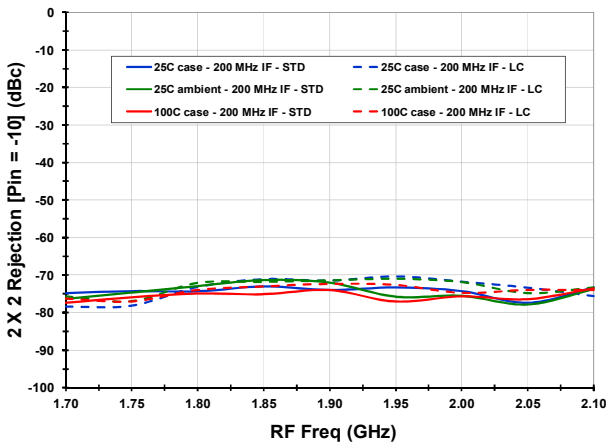

Input 1dB Compression

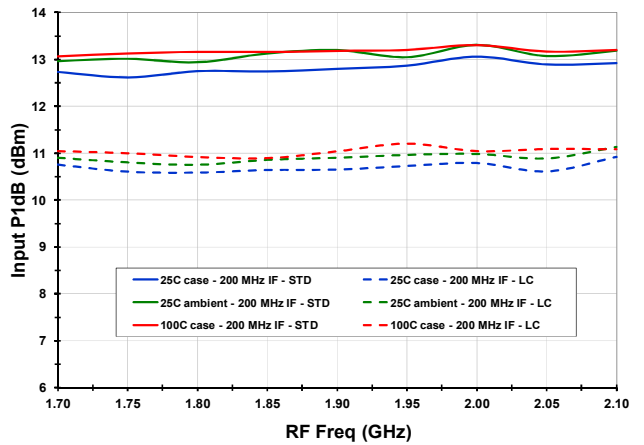

LO - IF leakage

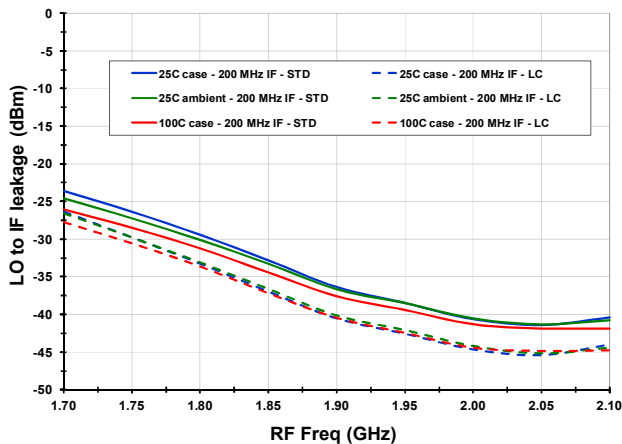

3RF x 3LO rejection

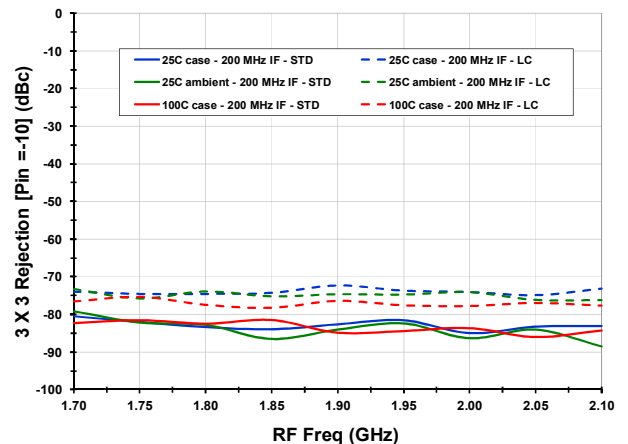

HIGH TEMP OPERATING CONDITIONS [350 MHz IF] (2)

Gain [EVKit de-embedded]

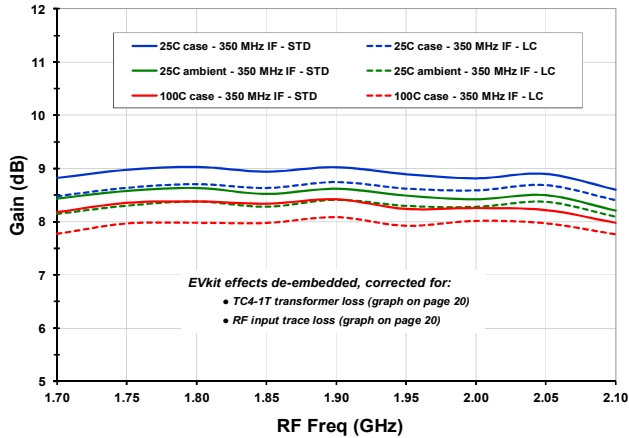

Output IP3 [EVkit de-embedded]

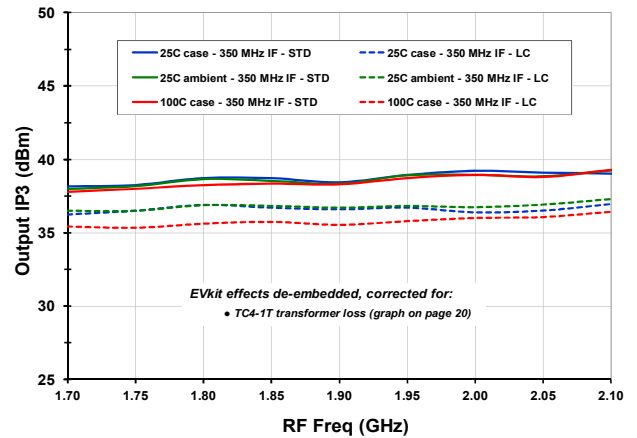

2RF x 2LO rejection

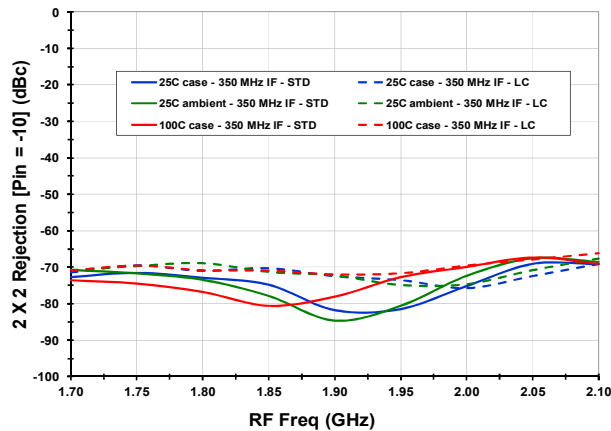

Input 1dB Compression

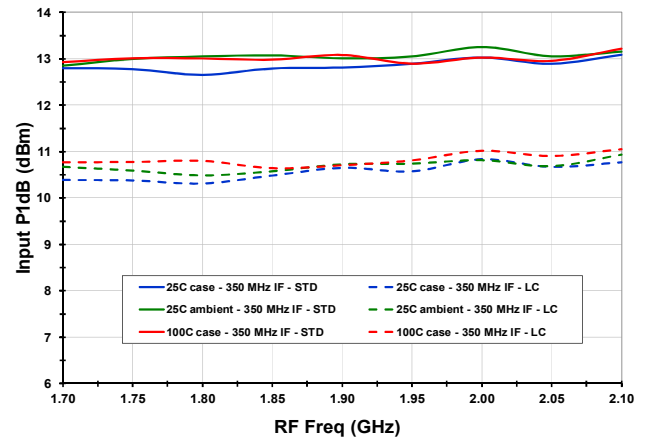

LO - IF leakage

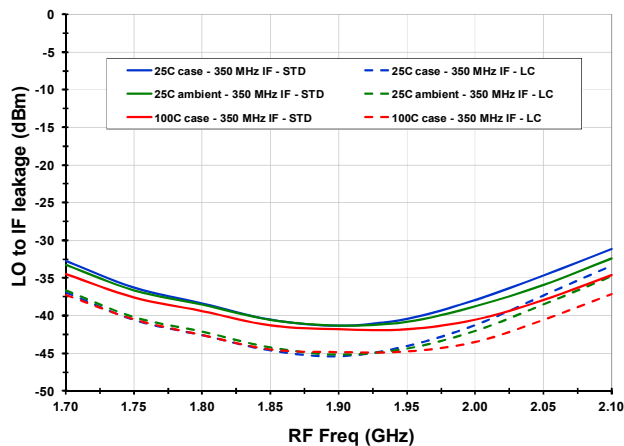

RF - IF leakage

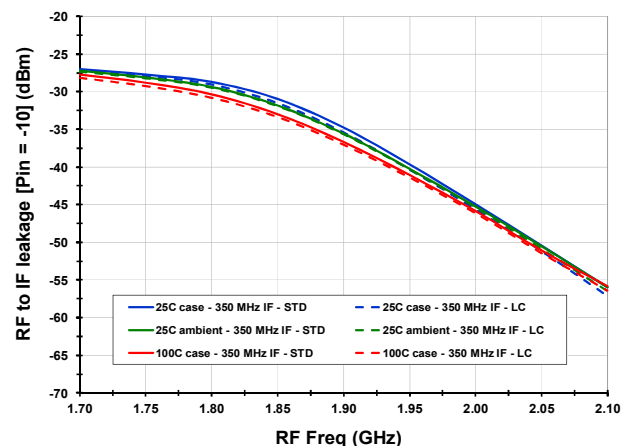

HIGH TEMP OPERATING CONDITIONS [GENERAL] (3)

Channel Isolation

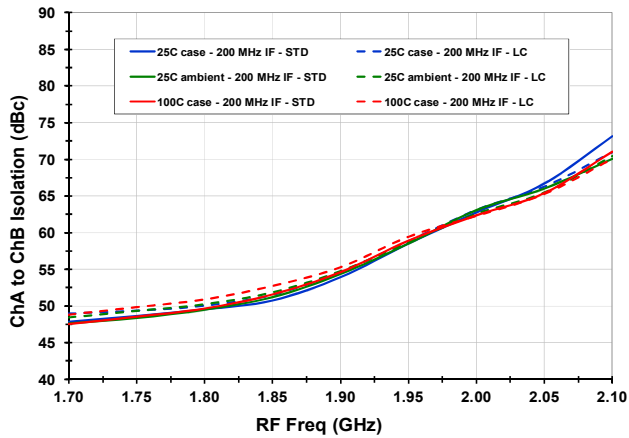

Output IP2

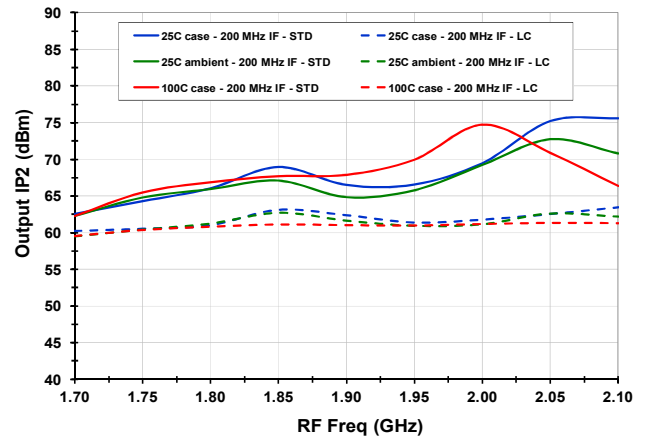

Noise Figure [EVkit de-embedded]

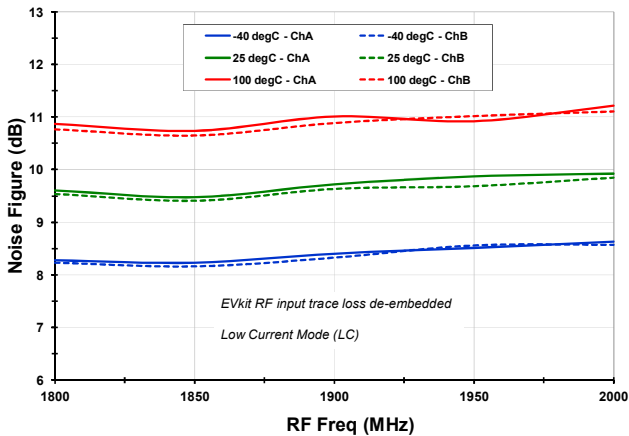

Output 1dB Compression [EVkit de-embedded]

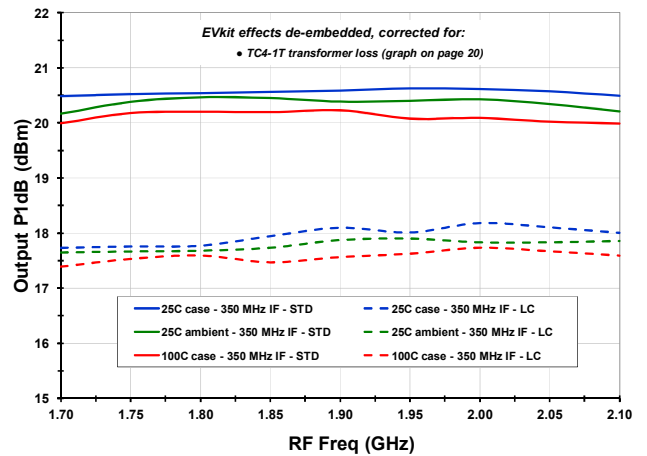

EVkit RF trace loss

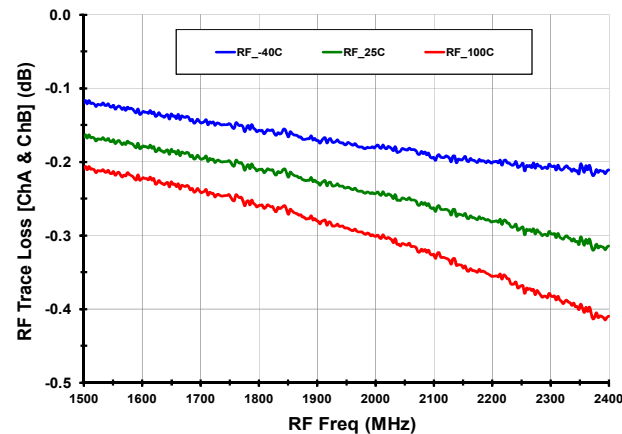

EVkit Transformer Loss

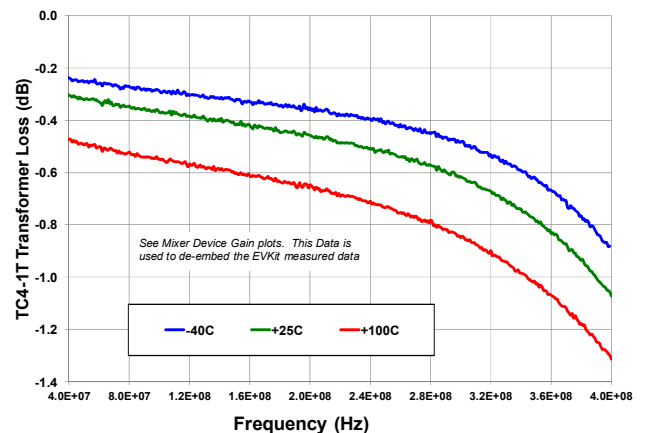

RF to IF Dual Downconverting Mixer

1700 - 2200 MHz F1150NBGI

PACKAGE DRAWING (6X6 QFN)

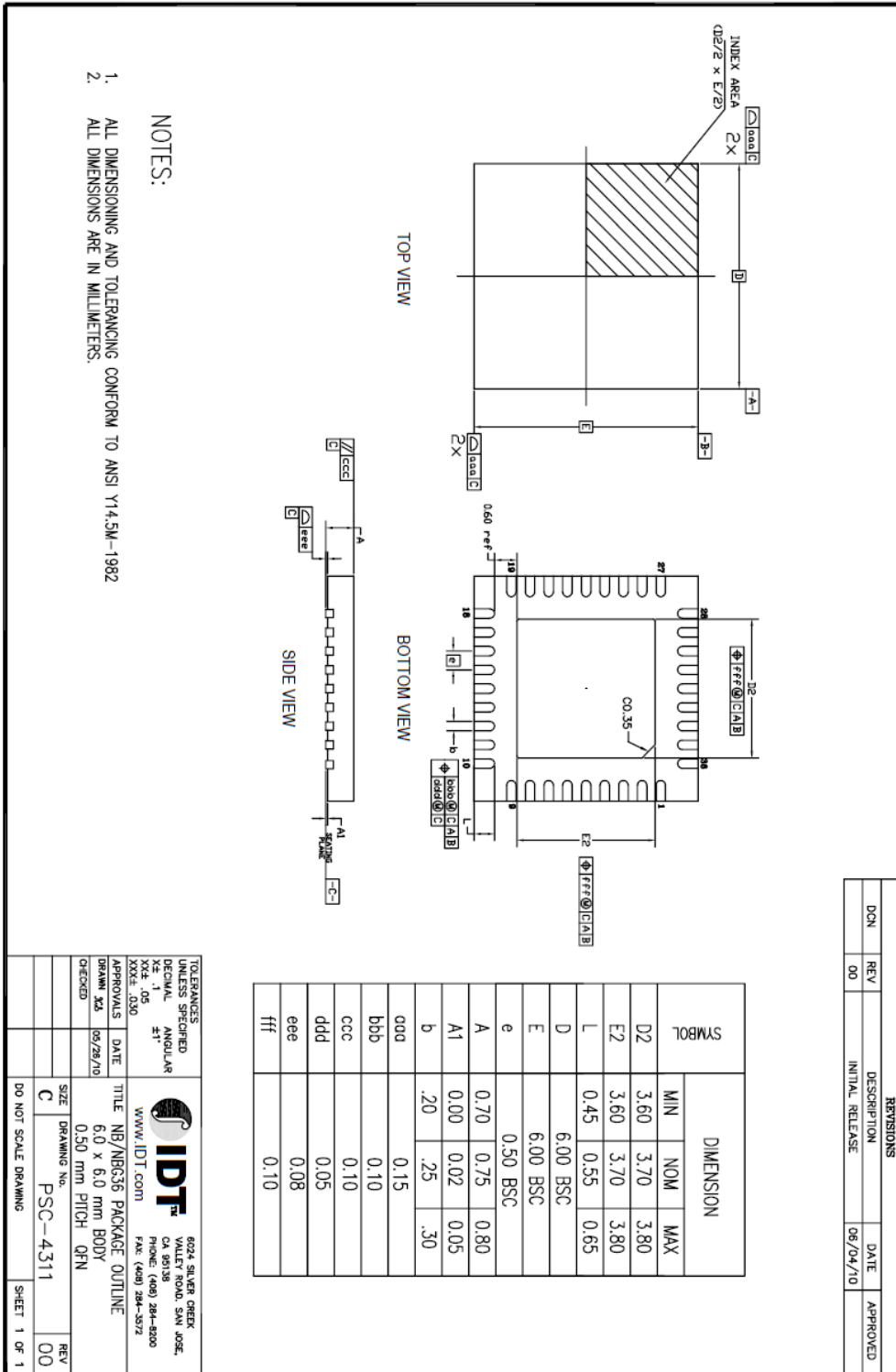

REVISIONS			
DCN	REV	DESCRIPTION	DATE
00	00	INITIAL RELEASE	09/04/10

TOLERANCES UNLESS SPECIFIED		6024 SILVER CREEK	
DECIMAL	ANGULAR	VALLEY ROAD, SAN JOSE, CA 95138	
XX.X	.05	PHONE: (408) 284-8500	
XXX.X	.030	FAX: (408) 284-8572	
APPROVALS		DATE	
DRAWN	19/28/10	TITLE	
CHECKED		NB/NB635 PACKAGE OUTLINE	
SIZE		DRAWING No.	
C		PSC-4311	
DO NOT SCALE DRAWING		REV	
		00	
		SHEET 1 OF 1	

RF to IF Dual Downconverting Mixer

1700 - 2200 MHz F1150NBGI

PINOUTS

Black Text denotes recommended external connection

Red Text denotes internal Function or Connection

- DB GND = Downbonded to Paddle

- Internal NC = Pin not connected

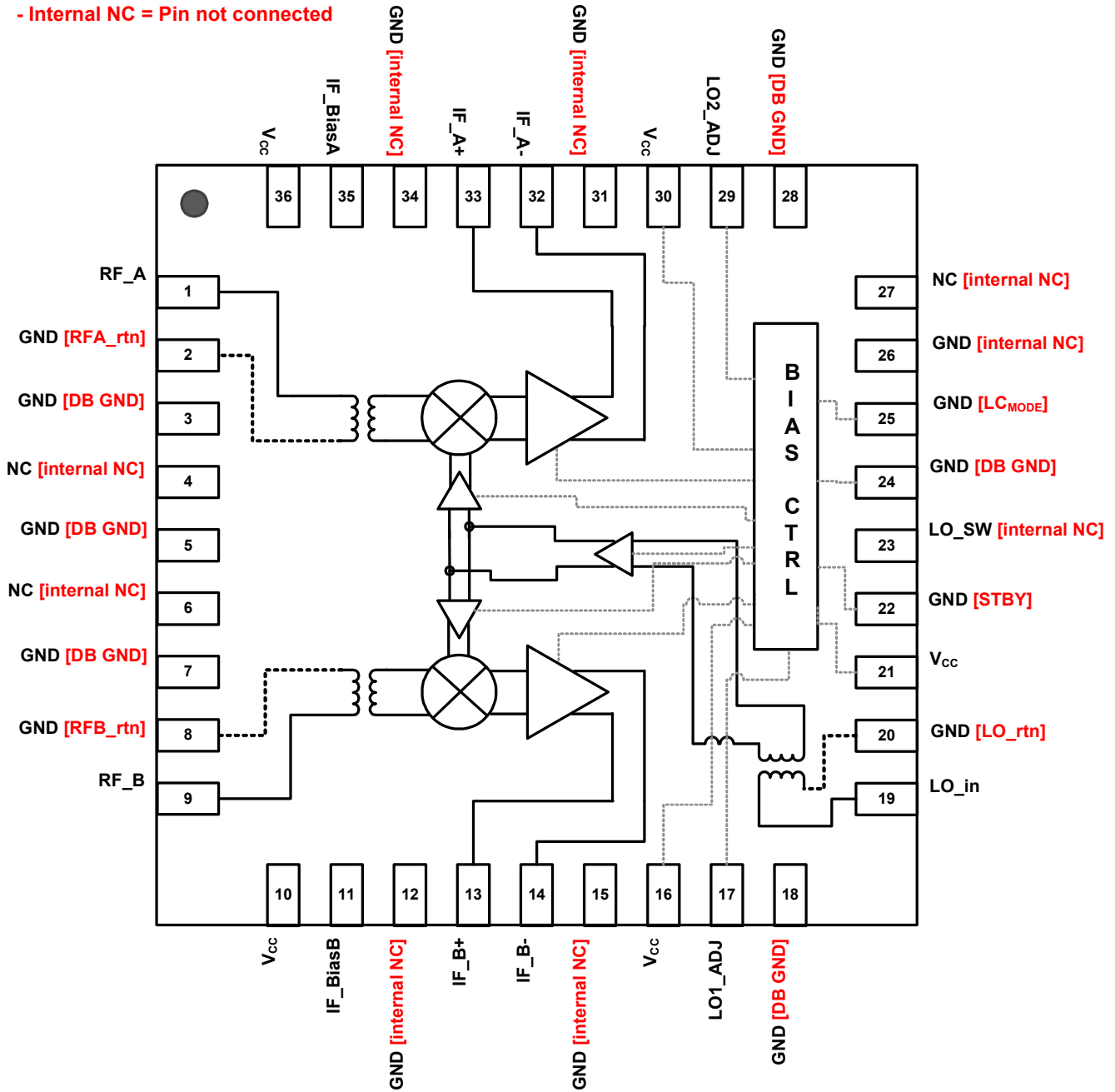

PIN DESCRIPTIONS

Pin(s)	Name	Function
1	RF_A	Main Channel RF Input. Internally matched to 50Ω. DO NOT apply DC to these pins
2, 8, 20	RF_Artn, RF_Brtn, LO_rtn	Transformer Ground Returns. Ground these pins.
3, 5, 7, 18, 22, 24, 28	GND	Ground these pins.
4, 6, 12, 15, 31, 23, 26, 27, 34	N.C.	No Connection. Not internally connected. OK to connect to Vcc. OK to connect to GND
10, 16, 21, 30, 36	VCC	Power Supplies. Bypass to GND with capacitors shown in the Typical Application Circuit as close as possible to pin.
9	RF_B	Diversity Channel RF Input. Internally matched to 50Ω
11	IF_BiasB	Connect the specified resistor from this pin to ground to set the bias for the Diversity IF amplifier. This is NOT a current set resistor
13, 14	IFB+, IFB-	Diversity Mixer Differential IF Output. Connect pullup inductors from each of these pins to VCC (see the Typical Application Circuit).
17	LO1_ADJ	Connect the specified resistor for either Standard or LC mode from this pin to ground to set the LO common buffer Icc
19	LO_in	Local Oscillator Input. Connect the LO to this port through a series 3 pF capacitor
25	LC_MODE	Low_Current Mode. Set this pin to low or ground for LC mode. Set to high or No-Connect for Standard mode. There is an internal pull-up resistor.
22	STBY	STBY Mode. Pull this pin high for Standby mode (~20 mA). Pull low or Ground for normal Operation
29	LO2_ADJ	Connect the specified resistor for either Standard or LC mode from this pin to ground to set the LO drive buffers Icc
32, 33	IFA-, IFA+	Main Mixer Differential IF Output. Connect pullup inductors from each of these pins to VCC (see the Typical Application Circuit).
35	IF_BiasA	Connect the specified resistor from this pin to ground to set the bias for the Main IF amplifier. This is NOT a current set resistor
	— EP	Exposed Pad. Internally connected to GND. Solder this exposed pad to a PCB pad that uses multiple ground vias to provide heat transfer out of the device into the PCB ground planes. These multiple via grounds are also required to achieve the noted RF performance.

EVKIT SCHEMATIC

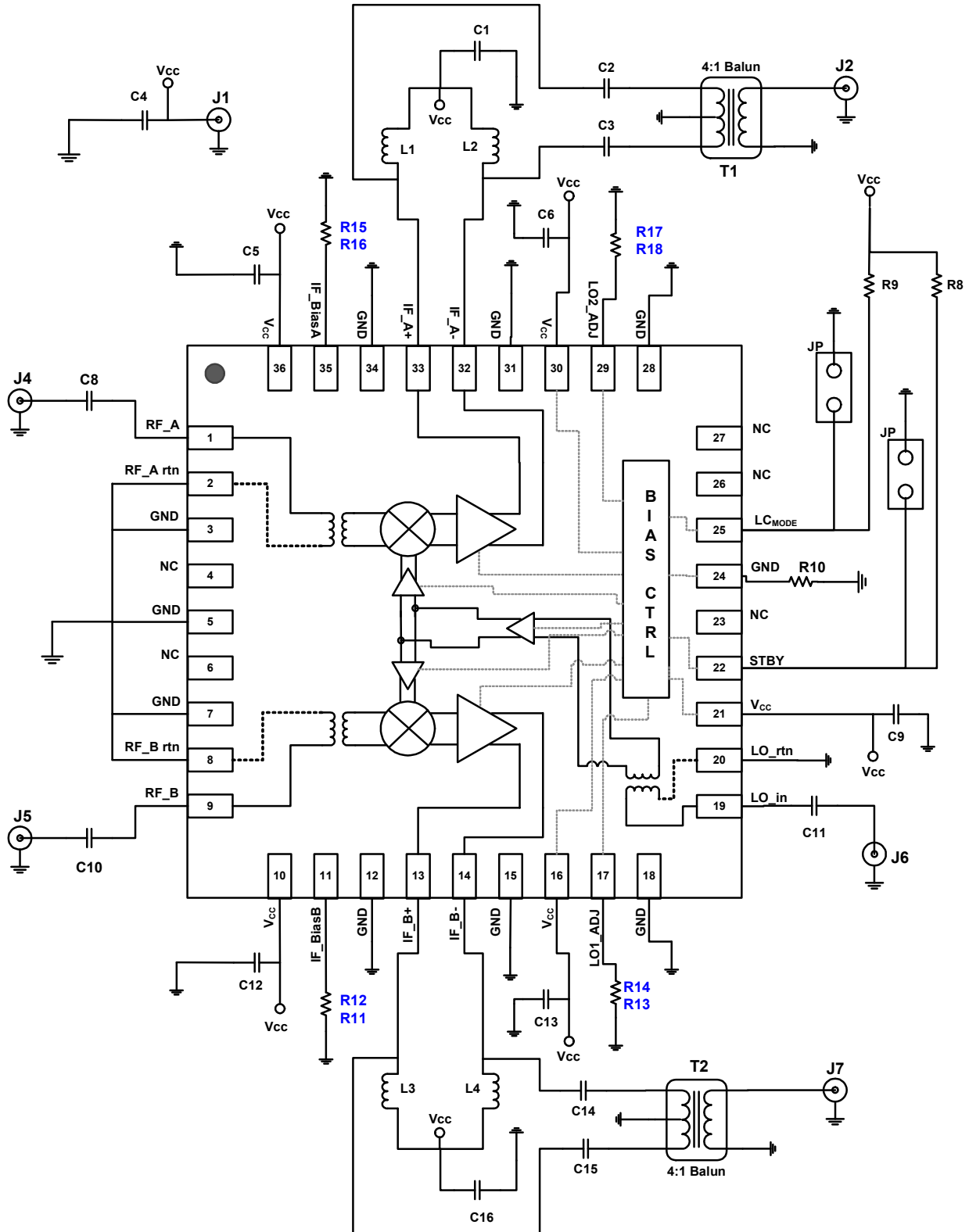

EVKIT PICTURE/LAYOUT/OPERATION

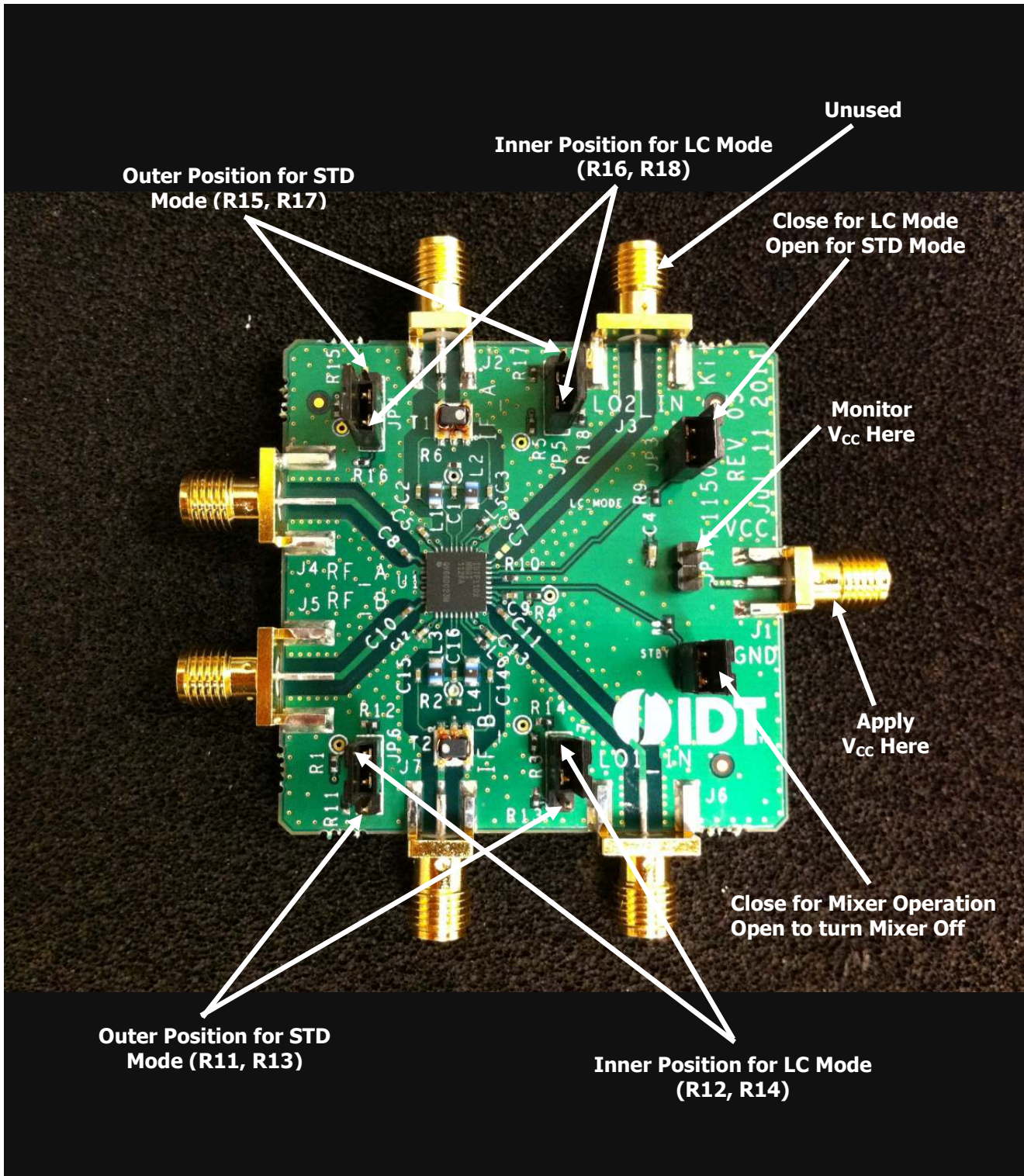

RF to IF Dual Downconverting Mixer
1700 - 2200 MHz F1150NBGI
EVKIT BOM

For Standard Mode, Open the LC_{MODE} jumper in conjunction with positioning the 4 dual jumpers to select the resistors in **red**.

For Low Current Mode close the LC_{MODE} jumper in conjunction with positioning the 4 dual jumpers to select the resistors in **blue**.

F1150 BOM

Item #	Value	Size	Desc	Mfr. Part #	Mfr.	Part Reference	Qty
1	10nF	0402	CAP CER 10000PF 16V 10% X7R 0402	GRM155R71C103KA01D	MURATA	C1,5,6,9,12,13,16	7
2	1000pF	0402	CAP CER 1000PF 50V C0G 0402	GRM1555C1H102JA01D	MURATA	C2,3,14,15	4
3	1.2nH	0402	0402CS-1N2XJLU Ceramic Chip Inductor	0402CS-1N2XJLU	COILCRAFT	C8,10	2
4	3pF	0402	CAP CER 3PF 0402	GRM1555C1H3R0CZ01D	MURATA	C11	1
5	10uF	0603	CAP CER 10UF 6.3V X5R 0603	GRM188R60J106ME47D	MURATA	C4	1
6	Header 2 Pin	TH 2	CONN HEADER VERT SGL 2POS GOLD	961102-6404-AR	3M	JP1,2,3	3
7	Header 3 Pin	TH 3	CONN HEADER VERT SGL 3POS GOLD	961103-6404-AR	3M	JP4,5,6,7	4
8	SMA_END_LAUNCH	.062	SMA_END_LAUNCH	142-0711-821	Emerson Johnson	J1,2,3,4,5,6,7	7
9	270nH	0805	0805CS (2012) Ceramic Chip Inductor	0805CS-271XJLB	COILCRAFT	L1,2,3,4	4
10	27	0402	RES 27 OHM 1/10W 1% 0402 SMD	ERJ-2RKF27R0X	Panasonic	R11,15	2
11	63	0402	RES 63 OHM 1/10W 1% 0402 SMD	ERJ-2RKF63R0X	Panasonic	R12,16	2
12	91	0402	RES 91.0 OHM 1/10W 1% 0402 SMD	ERJ-2RKF91R0X	Panasonic	R13	1
13	180	0402	RES 180 OHM 1/10W 1% 0402 SMD	ERJ-2RKF1800X	Panasonic	R14	1
14	1.91K	0402	RES 1.91K OHM 1/10W 1% 0402 SMD	ERJ-2RKF1911X	Panasonic	R18	1
15	1.21K	0402	RES 1.21K OHM 1/10W 1% 0402 SMD	ERJ-2RKF1211X	Panasonic	R17	1
16	47K	0402	RES 47.0K OHM 1/16W 1% 0402 SMD	RC0402FR-0747KL	Yageo	R8,9	2
17	0	0402	RES 0.0 OHM 1/10W 0402 SMD	ERJ-2GE0R00X	Panasonic	R1,2,3,4,5,6,7,10	10
18	4:1 Balun	SM-22	4:1 Center Tap Balun	TC4-1TG2+	Mini Circuits	T1,2	2
19	F1150ZM (021)	QFN-36	Diversity Downconverter		IDT	U1	1
20	PCB			F1150 EVKit Rev5			1

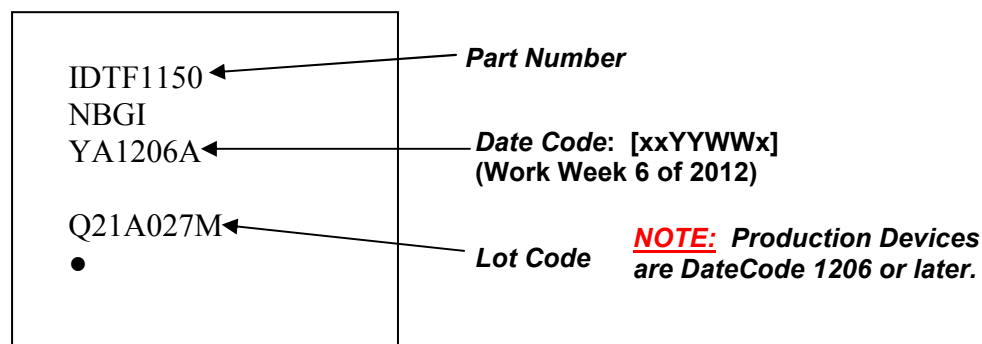
TOPMARKINGS

Mouser Electronics

Authorized Distributor

Click to View Pricing, Inventory, Delivery & Lifecycle Information:

[IDT \(Integrated Device Technology\):](#)

[F1150NBGI8](#) [F1150NBGI](#)