

LMP92064EVM BoosterPack User's Guide

This user's guide describes the characteristics, operation and use of the BOOST-LMP92064EVM. It also discusses how to setup and configure the software and hardware for a typical operation. This user's guide also includes printed circuit board (PCB) layout drawings, an electrical schematic and a bill of materials of the board. Throughout this document, the terms *BoosterPack*, *evaluation board*, *evaluation module* or *EVM* may be used and they are synonymous with the BOOST-LMP92064EVM.

Contents

1	Overview	1
2	EVM Components	2
3	Software Setup	5
4	EVM Setup and Operation	6
5	Other Software Features	9
6	PCB Layout	11
7	Schematic	14
8	Bill of Materials	15

List of Figures

1	LMP92064EVM BoosterPack overview	2
2	Pinout of headers for LaunchPad	3
3	Example setup	6
4	LMP92064EVM BoosterPack and MSP-EXP430F5529LP LaunchPad	7
5	BoosterPack attached to the MSP430 LaunchPad	7
6	Main tab	8
7	Registers tab	9
8	Graph tab	10
9	Top Components View	11
10	Top Layer Routing	11
11	Bottom Layer Routing	12
12	Mid Layer 1 Routing (Ground)	12
13	Mid Layer 2 Routing (Power)	13
14	Schematic	14

List of Tables

1	J1 and J2 pinout description	3
2	J3 and J4 pinout description	4
3	Bill of Materials	15

1 Overview

The Texas Instruments LMP92064 BoosterPack helps designers evaluate the operation and performance of the [LMP92064](#). The LMP92064 is a precision, low-side, digital current sensor and voltage monitor with a digital SPI interface. The LMP92064 features a current sense and a voltage sense channel, which are sampled simultaneously by independent 12-bit ADC converters.

The LMP92064 BoosterPack is designed to operate with a Texas Instruments MSP430 LaunchPad ([MSP-EXP430F5529LP](http://www.ti.com/launchpad)) connected to a PC. The LaunchPad is purchased separately and more information about the LaunchPad series can be found at <http://www.ti.com/launchpad>. A graphical user interface (GUI) is available for installation on a Windows PC and provides access to the registers of the LMP92064, allows reading ADC data and plotting it on the PC screen.

The BoosterPack includes digital isolators on the SPI lines that provide galvanic isolation for applications where the ground of the system being monitored may be at a different potential, like an isolated power supply.

2 EVM Components

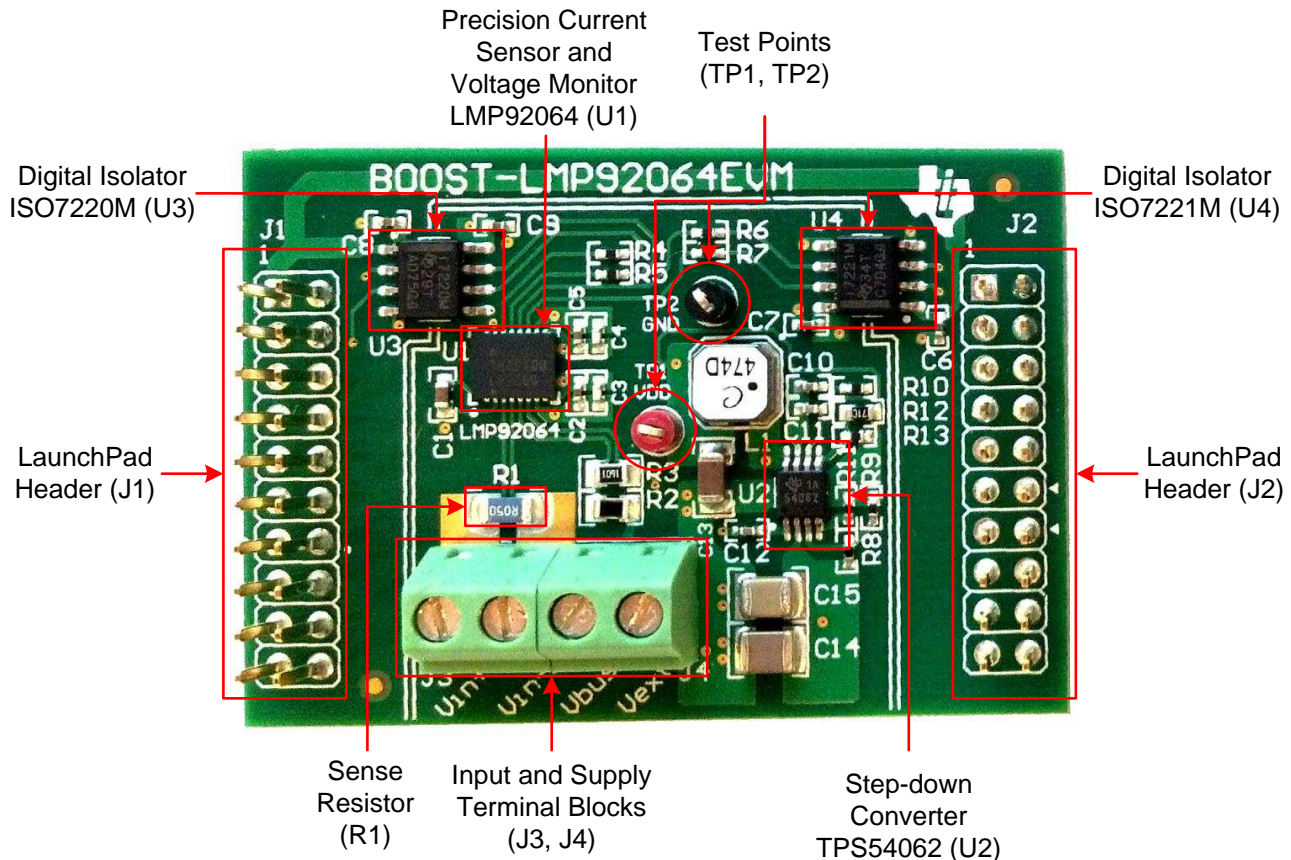

Figure 1. LMP92064EVM BoosterPack overview

U1 – LMP92064: Precision current sensor and voltage monitor. The LMP92064 measures (1) the voltage drop across R1 due to a load current flowing in though Vin+ and out through Vin- and (2) the voltage on R3 generated from a resistive voltage divider between R3 and R2 from the voltage applied at Vbus.

U2 – TPS54062: Synchronous step-down converter with low non-switching supply current. The TPS54062 and supporting circuit converts the voltage applied at Vext by stepping it down to 5V. The input voltage range of the step-down circuit (Vext) is from 12V to 48V.

U3, U4 – ISO7220M, ISO7221M: 150Mbps dual digital isolators connected between the SPI pins of the LMP92064 (CSB, SCLK, SDI, SDO) and headers J1 and J2.

TP1 – VDD: This test point is connected to the supply pin of the LMP92064 and the output of the step-down circuit. The typical voltage on this test point is around 5V.

TP2 – Ground: This test point is connected to the ground plane of the non-isolated area (inside area delimited by a double line on the top silkscreen).

J1, J2 – LaunchPad Headers: The connectors J1 and J2 are two 10x2 headers used to connect the LMP92064 BoosterPack to the MSP430 LaunchPad. Figure 2 shows a top view of the connectors with corresponding pin labels.

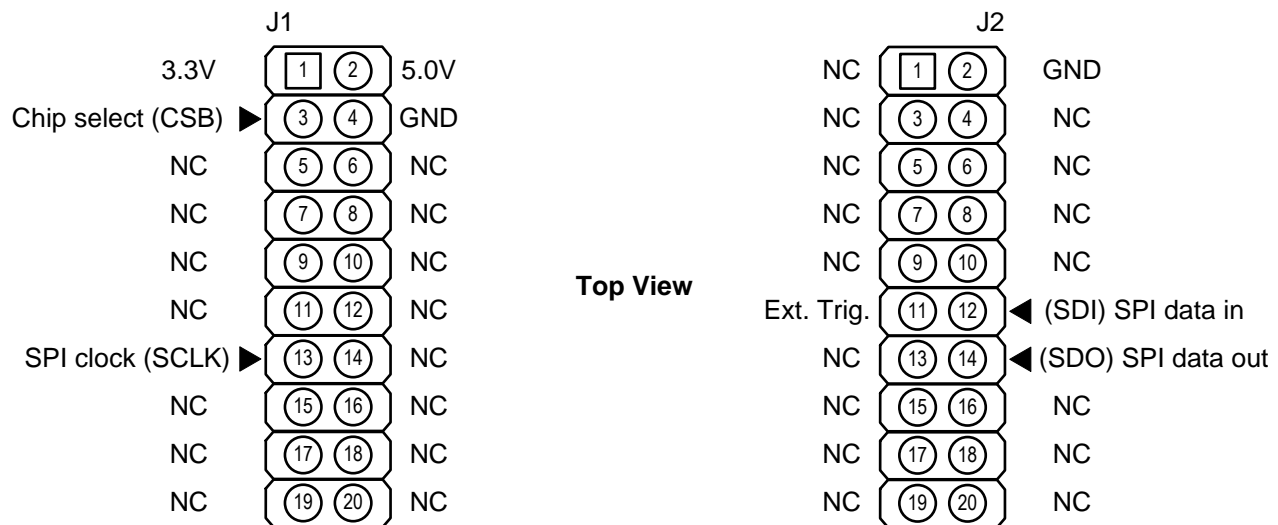

Figure 2. Pinout of headers for LaunchPad

The headers provide voltage supply connections, ground connections and SPI interface connections. A description of the pins is provided in Table 1.

Table 1. J1 and J2 pinout description

Connector	Pin Number	Description
J1	1	3.3V generated by the MSP430 LaunchPad. The 3.3V supply is used on the BoosterPack to power the isolated side of U3 and U4.
	2	5.0V generated by the MSP430 LaunchPad. The 5.0V supply is not used.
	3	Active low the chip select (CSB)
	4	Ground connection on the isolated side.
	5-12	No connection on BoosterPack ⁽¹⁾
	13	SPI clock (SCLK)
	14-20	No connection on BoosterPack ⁽¹⁾
J2	1	No connection on BoosterPack ⁽¹⁾
	2	Ground connection on the isolated side.
	3-10	No connection on BoosterPack ⁽¹⁾
	11	External trigger for LaunchPad (optional)
	12	SPI master out slave in (SDI)
	13	No connection on BoosterPack ⁽¹⁾
	14	SPI master in slave out (SDO)
15-20	No connection on BoosterPack ⁽¹⁾	

⁽¹⁾ Refer to LaunchPad documentation for pin description

R1 – Sense resistor: Preassembled 0.05Ω current sense resistor (0.5W). The current through this resistor should be limited to its power rating to avoid damaging the component and/or board.

R2, R3 – Voltage divider: These resistors create a resistive divider for the voltage channel of the LMP92064. R2 is a 46.4kΩ resistor and R3 is a 1.6kΩ resistor. The voltage at the voltage channel is:

$$V_{INVP} = V_{BUS} \frac{R3}{R2 + R3} \quad (1)$$

The ratio of the resistors are chosen such that the division of the maximum expected VBUS voltage remains below 2.048V, which is the full-scale range of the LMP92064's voltage channel.

J3, J4 – Input and supply terminal blocks: These terminal blocks allow connecting the BoosterPack to a system and monitor load current and supply for an accurate power calculation. J3 is used to connect the Boosterpack in series (low-side) of a load and J4 is used to connect the BoosterPack to the supply of that load. The load current should not exceed the power rating of the sense resistor (R1) and the load supply should be limited to 48V. [Table 2](#) provides a more detailed description of the terminal block pins.

Table 2. J3 and J4 pinout description

Connector	Pin Number	Description
J3	1	Vin+ should connect to the low side of the load being monitored. On the BoosterPack, this terminal connects to R1 and the positive pin of the current channel of the LMP92064.
	2	Vin- should connect to ground of the system being monitored. On the BoosterPack, this terminal connects to R1 and the negative pin of the current channel of the LMP92064. This pin also serves as the ground reference of the non-isolated area of the BoosterPack.
J4	1	Vbus should connect to the positive terminal of the load's power supply. On the BoosterPack, this terminal connects to R2. The negative terminal of the load's power supply should connect to Vin- as shown in Figure 3 .
	2	Vext should connect to the positive terminal of the load's power supply or other power supply. On the BoosterPack, this terminal is connected to the step-down converter circuit and the input voltage range is from 12V to 48V. The negative terminal of the power supply should connect to Vin- as shown in Figure 3 .

3 Software Setup

Complete all the steps on this page before launching the LMP92064EVM GUI software for the first time.

3.1 Graphical User Interface (GUI)

The latest software for the BoosterPack can be downloaded from ti.com. The software must be installed before connecting the boards to the PC. The software is compatible with Windows XP and Windows 7.

To install the software:

1. Navigate to <http://www.ti.com/tool/boost-imp92064evm>, scroll down to the **Software** section and download the latest version of the evaluation software.
2. Unzip the downloaded file into a known directory and run the "setup.exe" file located in [Unzip location]\LMP92064EVM_Software_vXX\Installer\Volume
3. Follow the on-screen instructions to install the software; when the installation completes, click the *Finish* button to exit.

3.2 LaunchPad Firmware Upgrade

The microprocessor on the MSP-EXP430F5529LP LaunchPad must be re-programmed with custom firmware to operate with the GUI and the LMP92064EVM BoosterPack. Updating the firmware requires the installation of the MSP430 USB Firmware Upgrade Example, which can be downloaded from the TI website.

MSP430 Firmware Upgrade application installation

1. Navigate to <http://www.ti.com/tool/msp430usbdevpack> and click on **Get Software**.
2. Scroll-down to the end of the page to find the **USB Collateral Installers** section.
3. Click on MSP430_USB_Firmware_Upgrade_Example-x-x-x-Setup.exe to download the tool; the page will redirect to a submission form.
4. Complete the information requested and submit the form; if approved, a download button will appear.
5. Run the installation file and follow the on-screen instructions until completion. When asked about the setup type, select **Application Only**. Click *Finish* when done.

Firmware upgrade

1. Download the latest copy of the firmware from the tools page of the LMP92064EVM BoosterPack: <http://www.ti.com/tool/boost-imp92064evm>
2. Open the MSP430 USB Firmware Upgrade application. By default, the application can be launched from **Start >> Programs >> Texas Instruments >> MSP430 USB Firmware Upgrade Example**.
3. Click *Next* to proceed on the first prompt; read and accept the license agreement and click *Next* to continue.
4. Enable the *Select Firmware radio* button and browse to open the downloaded firmware.
5. Press the BSL button on the MSP430 LaunchPad and connect to the PC with a USB cable; if detected, the text on the Firmware Upgrade tool will change from *No device connected* to *Found 1 device*.
6. Click on the *Upgrade Firmware* button. When done, close the application and unplug the USB cable..

3.3 Update USB Driver

1. Connect the USB cable from the LaunchPad to the PC, open the Device Manager and find the MSP430-USB Example device. Right-click and choose *Update Driver Software*.
2. Select the *Browse my computer for driver software* option. Navigate and select the *Driver* folder located in the directory where the LMP92064 evaluation software was extracted.
3. If prompted with a warning window, select **Install this driver software anyway** for Windows to proceed with the installation.
4. Close the setup window when the installation is complete. The Device Manager should now display an **MSP430 Virtual COM Port** item followed by a COM port number. Take note of this number as it will be required to connect to the board from the GUI.

4 EVM Setup and Operation

4.1 Required Hardware

- 1x MSP-EXP430F5529LP LaunchPad
- 1x USB to microUSB cable
- 1x Power supply (48V, >1A)
- 1x Programmable load or current source of 1A
- Miscellaneous cables

4.2 Connections

1. Attach the LMP92064 BoosterPack on the MSP430 LaunchPad using connectors J1 and J2. The BoosterPack should sit easily over the LaunchPad (see [Figure 4](#) and [Figure 5](#) for reference).
2. With the output disabled, connect the positive terminal of the power supply to the programmable load and the negative terminal of the power supply to the Vin- terminal of the BoosterPack. Configure the supply's output to 48V and the current limit to 1.02A.
3. Also, connect the positive terminal of the power supply to the Vbus and the Vext terminals of the BoosterPack. It is recommended to use a star connection as depicted in [Figure 3](#).
4. Connect the negative terminal of the programmable load to the Vin+ terminal of the BoosterPack.

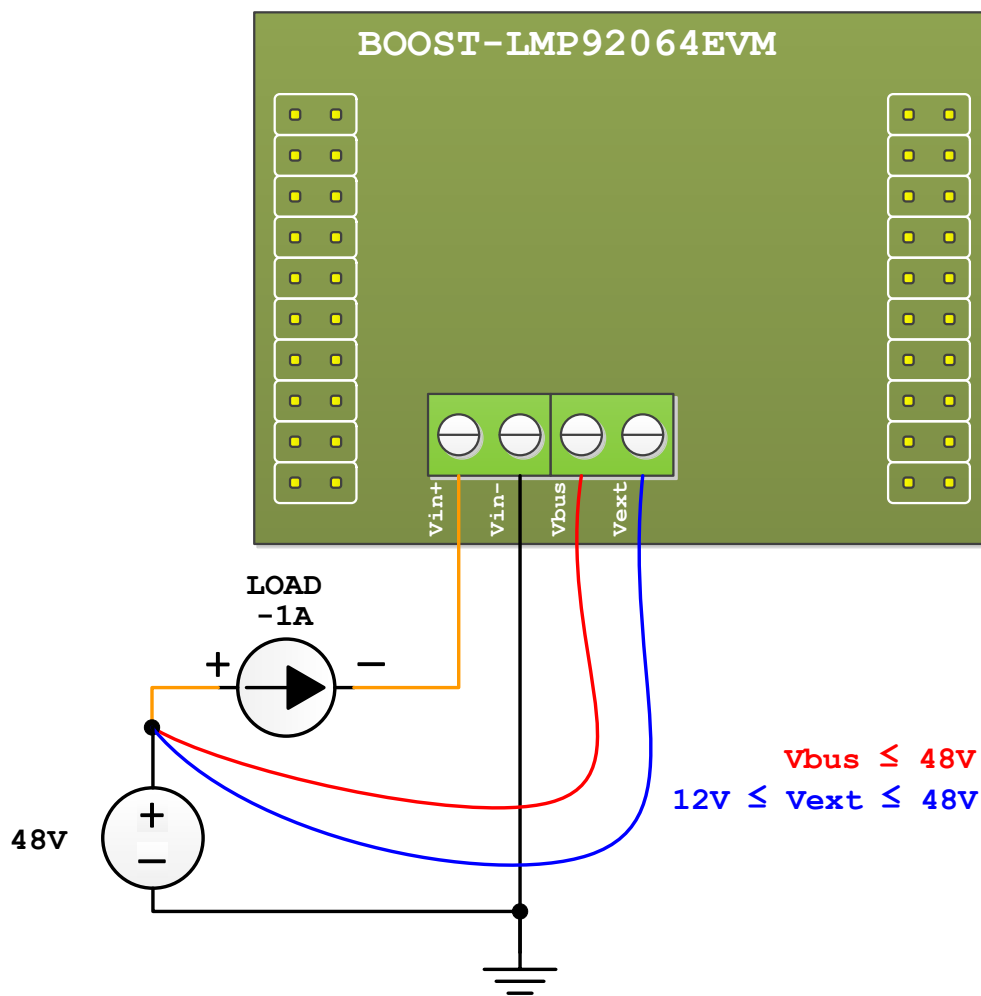

Figure 3. Example setup

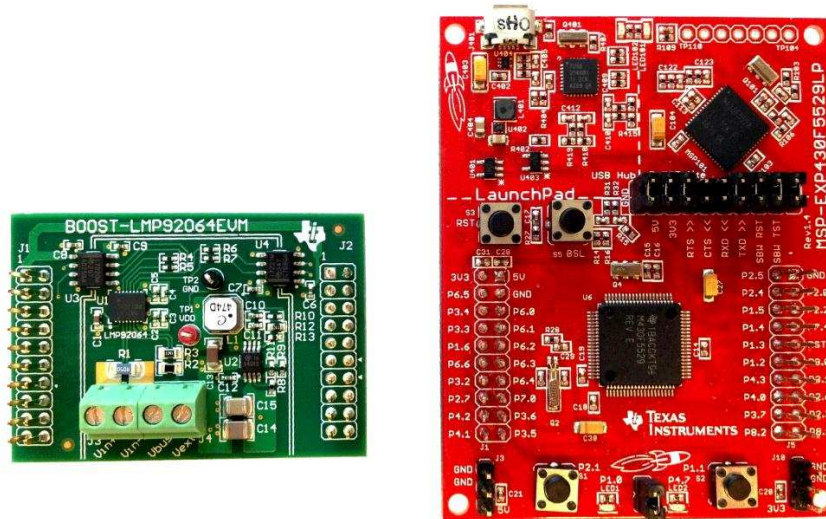

Figure 4. LMP92064EVM BoosterPack and MSP-EXP430F5529LP LaunchPad

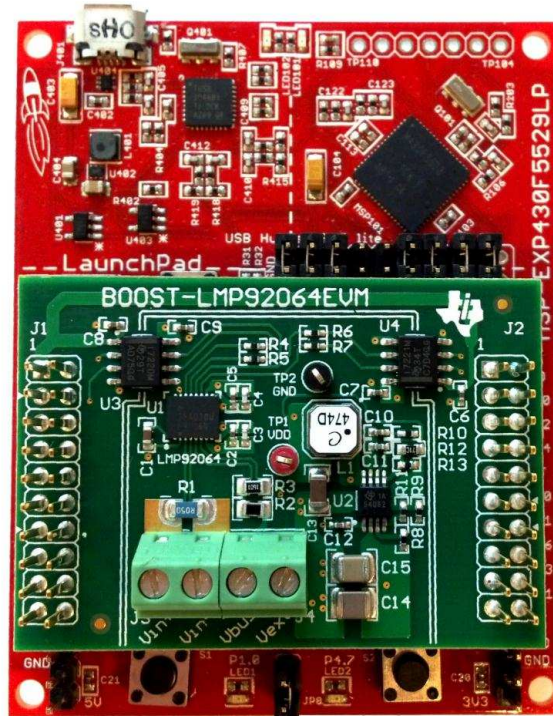

Figure 5. BoosterPack attached to the MSP430 LaunchPad

4.3 Power-up Sequence

1. Enable the output of the power supply (previously configured to 48V).
2. Configure the current load to sink 1A and enable it.
3. Connect the USB cable from the LaunchPad to the PC.

4.4 Running the Software

The GUI can be run from the Start Menu; by default, it is located in a folder called LMP92064.

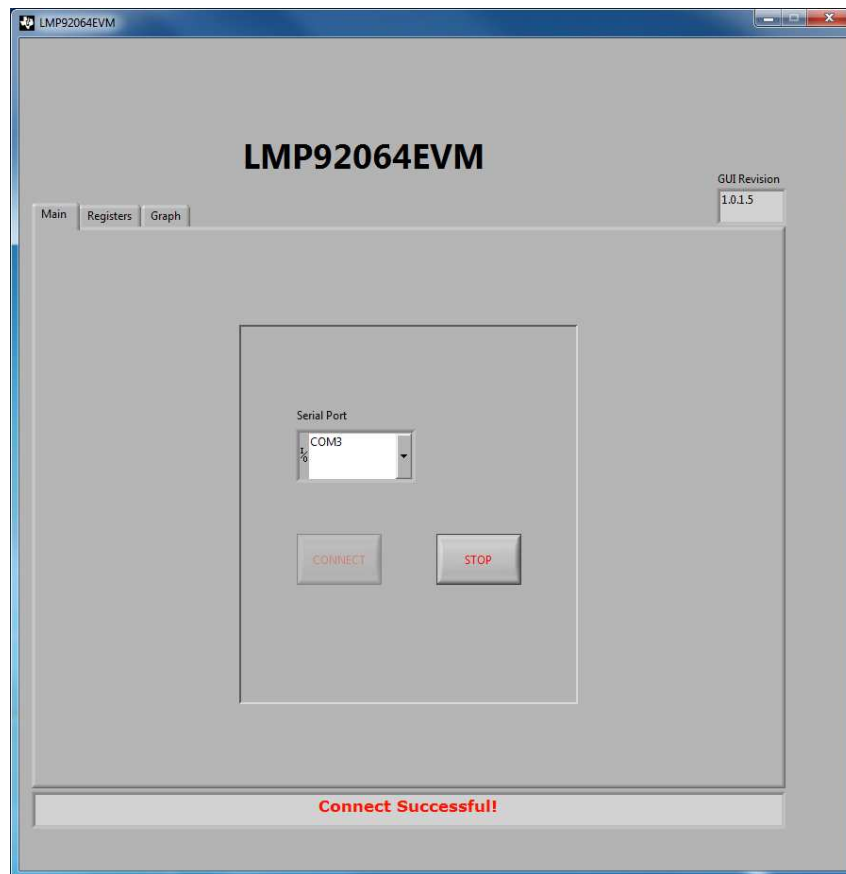

Figure 6. Main tab

1. Enter the serial port number in the *Main* GUI tab and click on CONNECT. If the board is found, the GUI returns a “Connect Successful!” message.
2. Go to the *Graph* tab and click on the Start Graph button to begin capturing and plotting data. By default, the Y-axis units are set to Output Code.
3. Click on Stop Graph to stop capturing and plotting data.
 - (a) **Voltage Channel:** The voltage channel measures the 48V connected to Vbus through a resistive divider of R3 = 1.6kΩ and R2 = 46.4kΩ. The output code is calculated as:

$$V_{CODE} = 48V \times \frac{1.6k\Omega}{48k\Omega} \times \frac{4096}{V_{REF}} \quad (2)$$

Where $V_{REF} = 2.048V$

- (b) **Current Channel:** The current channel measures the load current (1A) flowing through R1 = 50mΩ. The output code is calculated as:

$$C_{CODE} = \frac{1A \times 50m\Omega \times 4096 \times Gain}{V_{ref}} \quad (3)$$

Where Gain = 25 and $V_{REF} = 2.048V$

4.5 Power-down

1. Go back to the Main tab and click on the STOP button to disconnect the COM port and stop the execution of the GUI. Close the application and disconnect the USB cable.
2. Disable the programmable load.
3. Disable the output of the power supply.

5 Other Software Features

5.1 Registers Tab

The **Registers** tab provides access to the registers of the LMP92064 to execute read and write commands. Refer to the latest datasheet for details about each register.

Note that register 0x0000 – CONFIG_A is a buffered register. Writing a value to this register moves the data into a buffer, and in order to move this data to the real register location, a write to the 0x000F – REG_UPDATE register is required.

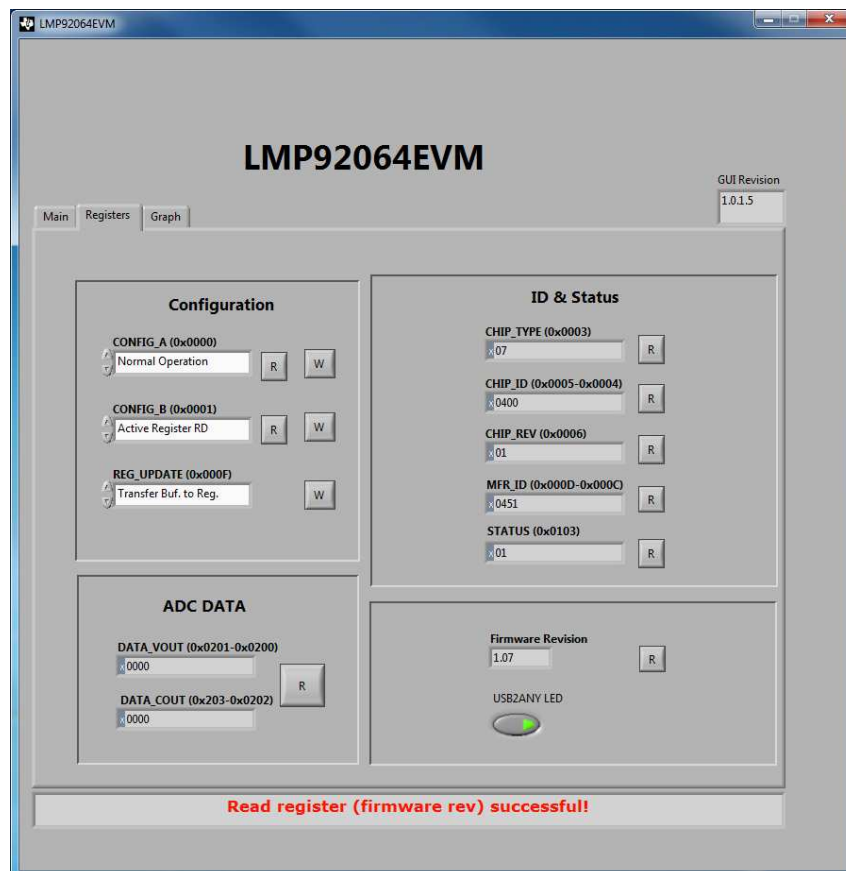

Figure 7. Registers tab

5.2 Graph Tab

The **Graph** tab allows capturing and displaying data from the Voltage and Current channel simultaneously. By default, the Y-axis scale is set to ADC codes, but it can be configured to display the data in milli-volts (mV) by enabling the *Y-axis in mV* check-box. This is an ideal analog-to-digital calculation assuming no accuracy errors.

A data capture is started by clicking on the **Start Graph** button and is stopped by clicking on the **Stop Graph** button. The data can be saved into a comma-separated value (CSV) file by enabling the *Save to File* check-box. When starting the data capture, you will be prompted to select a location and filename to save the data. Data is always saved as ADC output codes in HEX format.

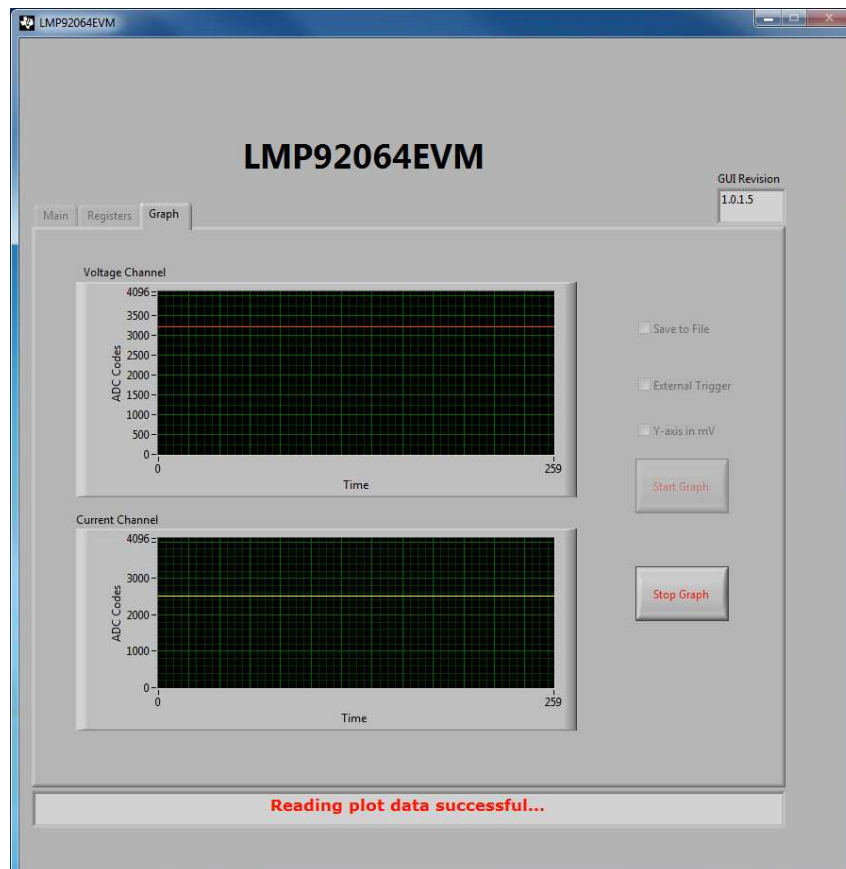

Figure 8. Graph tab

The data capture software uses an internal time trigger, collecting blocks of 10 current and voltage data samples every 500 μ s. An external signal can be used to trigger the capture of each of these 10 sample blocks:

1. Connect a 2 kHz or slower clock (3.3V compliant) to pin 11 of J2 on the BoosterPack.
2. Enable the **External Trigger** check-box and start the data capture.

Blocks of data are captured at every falling edge of the trigger pulse.

6 PCB Layout

NOTE: Note: The board layout is not to scale. The following figures are intended to show how the board is laid out; it is not intended to be used for manufacturing LMP92064EVM BoosterPack PCBs.

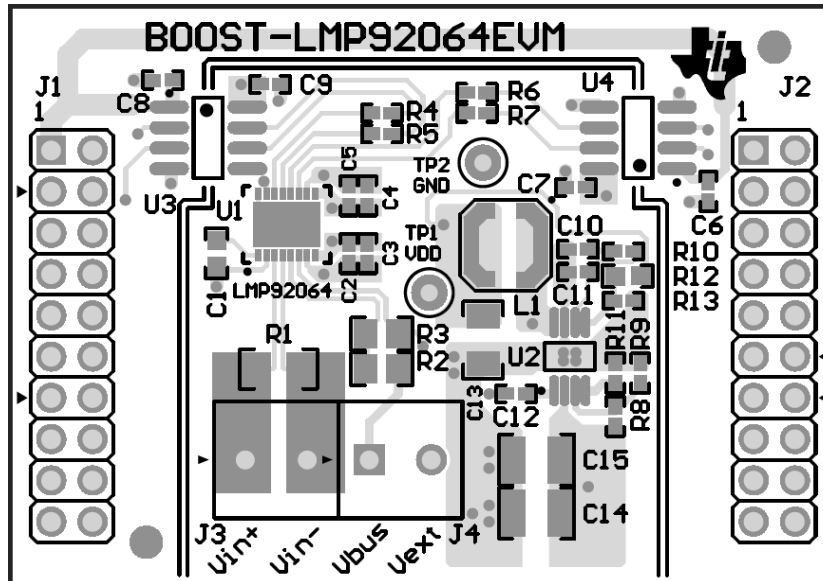

Figure 9. Top Components View

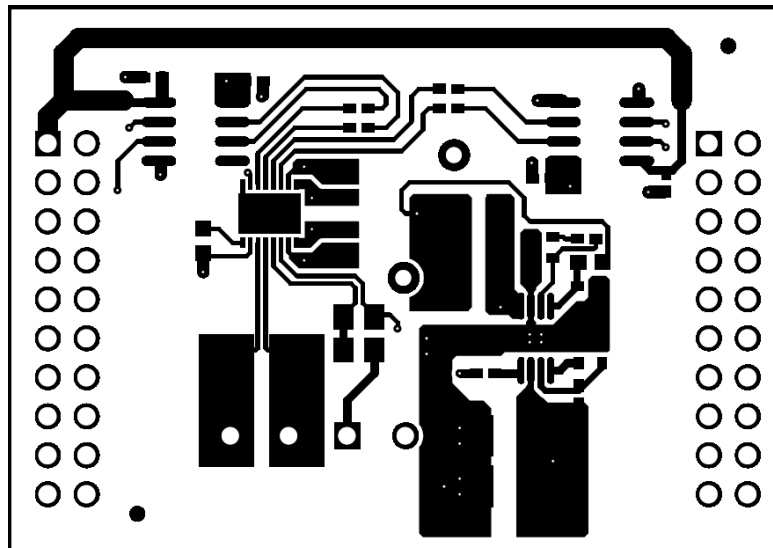

Figure 10. Top Layer Routing

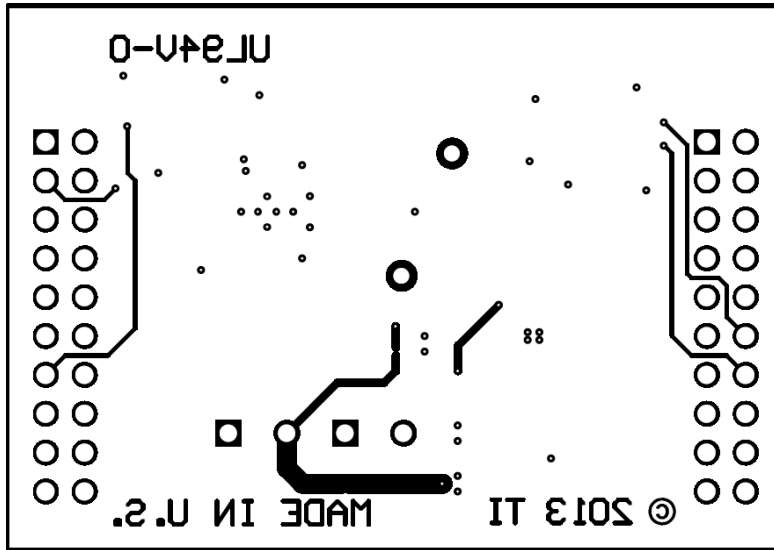

Figure 11. Bottom Layer Routing

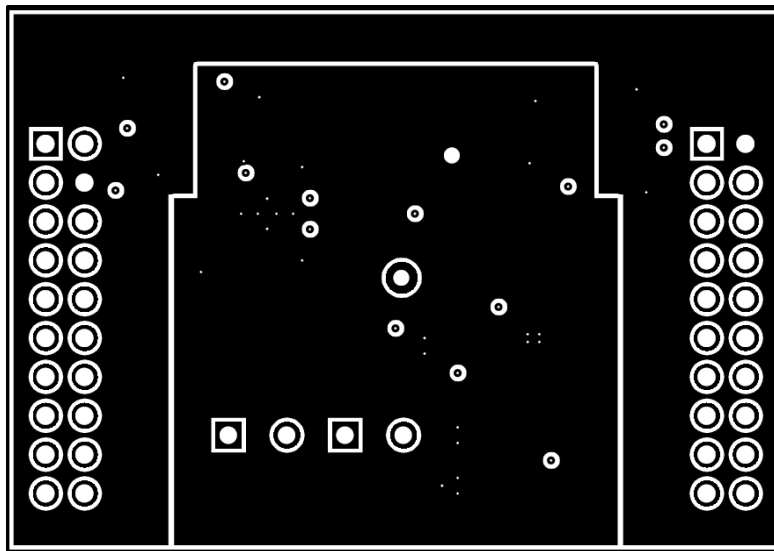

Figure 12. Mid Layer 1 Routing (Ground)

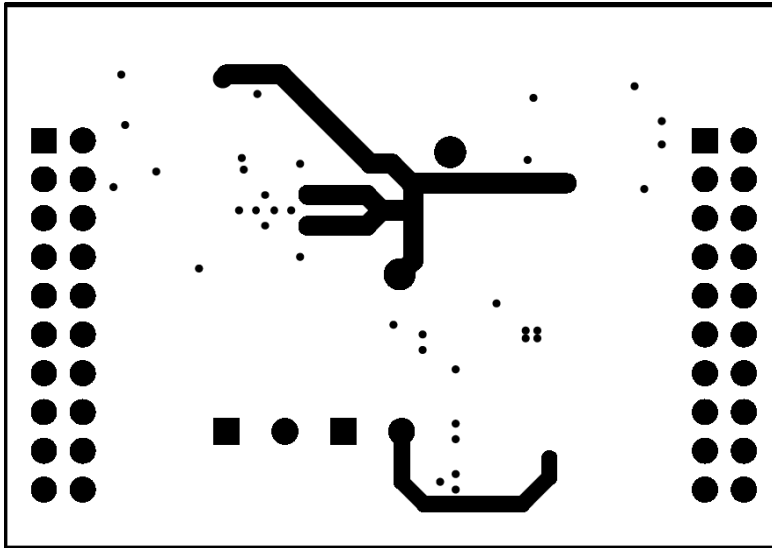

Figure 13. Mid Layer 2 Routing (Power)

7 Schematic

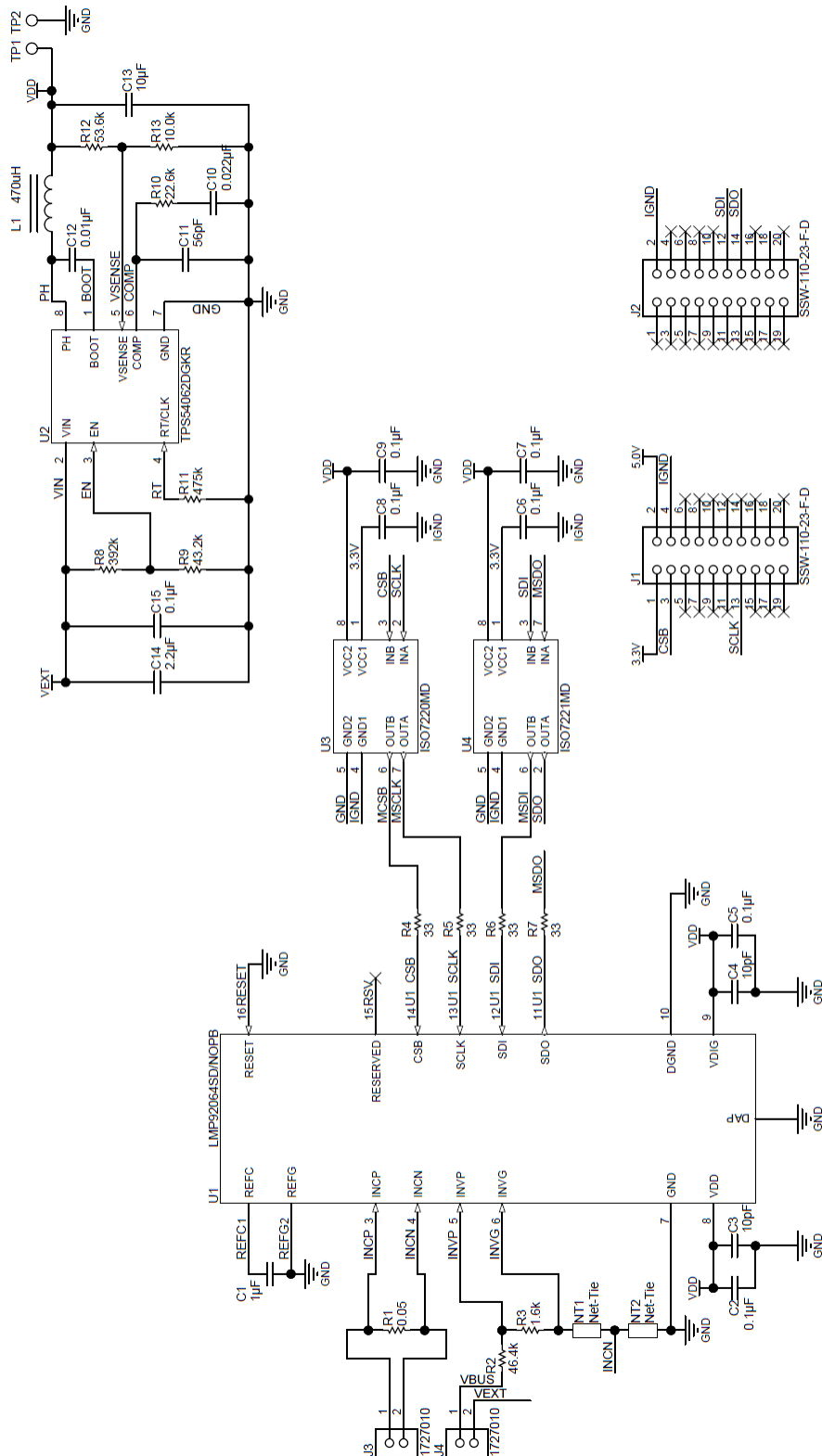

Figure 14. Schematic

8 Bill of Materials

Table 3. Bill of Materials

Item No.	Ref Des	Description	Vendor/Mfr	Part Number
1	EVM	BOOST-LMP92064EVM	Texas Instruments	SV601022
2	C1	CAP, CERM, 1uF, 16V, +/-10%, X7R, 0603	TDK	C1608X7R1C105K080AC
3	C2, C5, C6, C7, C8, C9	CAP, CERM, 0.1uF, 16V, +/-10%, X7R, 0402	MuRata	GRM155R71C104KA88D
4	C3, C4	CAP, CERM, 10pF, 50V, +/-5%, COG/NPO, 0402	MuRata	GRM1555C1H100JA01D
5	C10	CAP, CERM, 0.022uF, 50V, +/-10%, X7R, 0402	MuRata	GRM155R71H223KA12D
6	C11	CAP, CERM, 56pF, 50V, +/-5%, COG/NPO, 0402	MuRata	GRM1555C1H560JA01D
7	C12	CAP, CERM, 0.01uF, 25V, +/-10%, X8R, 0402	TDK	C1005X8R1E103K050BA
8	C13	CAP, CERM, 10uF, 25V, +/-10%, X5R, 1206	MuRata	GRM31CR61E106KA12L
9	C14	CAP, CERM, 2.2uF, 100V, +/-10%, X7R, 1210	Taiyo Yuden	HMK325B7225KN-T
10	C15	CAP, CERM, 0.1uF, 100V, +/-10%, X7R, 1210	Vishay-Vitramon	VJ1210Y104KBBAT4X
11	J1, J2	Connector, Receptacle, 100mil, 10x2, Gold plated, TH	Samtec	SSW-110-23-F-D
12	J3, J4	Conn Term Block, 2POS, 3.81mm, TH	Phoenix Contact	1727010
13	L1	Inductor, Shielded Drum Core, Ferrite, 470uH, 0.15A, 2.8 ohm, SMD	Coilcraft	LPS5030-474MLB
14	R1	RES, 0.05 ohm, 1%, 0.5W, 1206	TT Electronics/IRC	LRC-LR1206LF-01-R050F
15	R2	RES, 46.4k ohm, 0.1%, 0.125W, 0805	Susumu Co LTD	RG2012P-4642-B-T5
16	R3	RES, 1.6k ohm, 5%, 0.125W, 0805	Vishay-Dale	CRCW08051K60JNEA
17	R4, R5, R6, R7	RES, 33 ohm, 5%, 0.063W, 0402	Vishay-Dale	CRCW040233R0JNED
18	R8	RES, 392k ohm, 1%, 0.063W, 0402	Vishay-Dale	CRCW0402392KFKED
19	R9	RES, 43.2k ohm, 1%, 0.063W, 0402	Vishay-Dale	CRCW040243K2FKED
20	R10	RES, 22.6k ohm, 1%, 0.063W, 0402	Vishay-Dale	CRCW040222K6FKED
21	R11	RES, 475k ohm, 1%, 0.063W, 0402	Vishay-Dale	CRCW0402475KFKED
22	R12	RES, 53.6k ohm, 1%, 0.1W, 0603	Vishay-Dale	CRCW060353K6FKEA
23	R13	RES, 10.0k ohm, 1%, 0.063W, 0402	Vishay-Dale	CRCW040210K0FKED
24	TP1	Test Point, Miniature, Red, TH	Keystone	5000
25	TP2	Test Point, Miniature, Black, TH	Keystone	5001
26	U1	Precision Low-Side, Digital Current Sensor and Voltage Monitor	Texas Instruments	LMP92064SD/NOPB
27	U2	Buck Step Down Regulator with 4.7 to 60 V Input and 0.8 to 58 V Output	Texas Instruments	TPS54062DGKR
28	U3	150 Mbps Dual Channels, 2 / 0, Digital Isolator	Texas Instruments	ISO7220MD
29	U4	150 Mbps Dual Channels, 1 / 1, Digital Isolator	Texas Instruments	ISO7221MD

STANDARD TERMS AND CONDITIONS FOR EVALUATION MODULES

1. *Delivery:* TI delivers TI evaluation boards, kits, or modules, including any accompanying demonstration software, components, or documentation (collectively, an "EVM" or "EVMs") to the User ("User") in accordance with the terms and conditions set forth herein. Acceptance of the EVM is expressly subject to the following terms and conditions.
 - 1.1 EVMs are intended solely for product or software developers for use in a research and development setting to facilitate feasibility evaluation, experimentation, or scientific analysis of TI semiconductors products. EVMs have no direct function and are not finished products. EVMs shall not be directly or indirectly assembled as a part or subassembly in any finished product. For clarification, any software or software tools provided with the EVM ("Software") shall not be subject to the terms and conditions set forth herein but rather shall be subject to the applicable terms and conditions that accompany such Software
 - 1.2 EVMs are not intended for consumer or household use. EVMs may not be sold, sublicensed, leased, rented, loaned, assigned, or otherwise distributed for commercial purposes by Users, in whole or in part, or used in any finished product or production system.
2. *Limited Warranty and Related Remedies/Disclaimers:*
 - 2.1 These terms and conditions do not apply to Software. The warranty, if any, for Software is covered in the applicable Software License Agreement.
 - 2.2 TI warrants that the TI EVM will conform to TI's published specifications for ninety (90) days after the date TI delivers such EVM to User. Notwithstanding the foregoing, TI shall not be liable for any defects that are caused by neglect, misuse or mistreatment by an entity other than TI, including improper installation or testing, or for any EVMs that have been altered or modified in any way by an entity other than TI. Moreover, TI shall not be liable for any defects that result from User's design, specifications or instructions for such EVMs. Testing and other quality control techniques are used to the extent TI deems necessary or as mandated by government requirements. TI does not test all parameters of each EVM.
 - 2.3 If any EVM fails to conform to the warranty set forth above, TI's sole liability shall be at its option to repair or replace such EVM, or credit User's account for such EVM. TI's liability under this warranty shall be limited to EVMs that are returned during the warranty period to the address designated by TI and that are determined by TI not to conform to such warranty. If TI elects to repair or replace such EVM, TI shall have a reasonable time to repair such EVM or provide replacements. Repaired EVMs shall be warranted for the remainder of the original warranty period. Replaced EVMs shall be warranted for a new full ninety (90) day warranty period.
3. *Regulatory Notices:*
 - 3.1 *United States*
 - 3.1.1 *Notice applicable to EVMs not FCC-Approved:*

This kit is designed to allow product developers to evaluate electronic components, circuitry, or software associated with the kit to determine whether to incorporate such items in a finished product and software developers to write software applications for use with the end product. This kit is not a finished product and when assembled may not be resold or otherwise marketed unless all required FCC equipment authorizations are first obtained. Operation is subject to the condition that this product not cause harmful interference to licensed radio stations and that this product accept harmful interference. Unless the assembled kit is designed to operate under part 15, part 18 or part 95 of this chapter, the operator of the kit must operate under the authority of an FCC license holder or must secure an experimental authorization under part 5 of this chapter.
 - 3.1.2 *For EVMs annotated as FCC – FEDERAL COMMUNICATIONS COMMISSION Part 15 Compliant:*

CAUTION

This device complies with part 15 of the FCC Rules. Operation is subject to the following two conditions: (1) This device may not cause harmful interference, and (2) this device must accept any interference received, including interference that may cause undesired operation.

Changes or modifications not expressly approved by the party responsible for compliance could void the user's authority to operate the equipment.

FCC Interference Statement for Class A EVM devices

NOTE: This equipment has been tested and found to comply with the limits for a Class A digital device, pursuant to part 15 of the FCC Rules. These limits are designed to provide reasonable protection against harmful interference when the equipment is operated in a commercial environment. This equipment generates, uses, and can radiate radio frequency energy and, if not installed and used in accordance with the instruction manual, may cause harmful interference to radio communications. Operation of this equipment in a residential area is likely to cause harmful interference in which case the user will be required to correct the interference at his own expense.

FCC Interference Statement for Class B EVM devices

NOTE: This equipment has been tested and found to comply with the limits for a Class B digital device, pursuant to part 15 of the FCC Rules. These limits are designed to provide reasonable protection against harmful interference in a residential installation. This equipment generates, uses and can radiate radio frequency energy and, if not installed and used in accordance with the instructions, may cause harmful interference to radio communications. However, there is no guarantee that interference will not occur in a particular installation. If this equipment does cause harmful interference to radio or television reception, which can be determined by turning the equipment off and on, the user is encouraged to try to correct the interference by one or more of the following measures:

- Reorient or relocate the receiving antenna.
- Increase the separation between the equipment and receiver.
- Connect the equipment into an outlet on a circuit different from that to which the receiver is connected.
- Consult the dealer or an experienced radio/TV technician for help.

3.2 Canada

3.2.1 For EVMs issued with an Industry Canada Certificate of Conformance to RSS-210

Concerning EVMs Including Radio Transmitters:

This device complies with Industry Canada license-exempt RSS standard(s). Operation is subject to the following two conditions: (1) this device may not cause interference, and (2) this device must accept any interference, including interference that may cause undesired operation of the device.

Concernant les EVMs avec appareils radio:

Le présent appareil est conforme aux CNR d'Industrie Canada applicables aux appareils radio exempts de licence. L'exploitation est autorisée aux deux conditions suivantes: (1) l'appareil ne doit pas produire de brouillage, et (2) l'utilisateur de l'appareil doit accepter tout brouillage radioélectrique subi, même si le brouillage est susceptible d'en compromettre le fonctionnement.

Concerning EVMs Including Detachable Antennas:

Under Industry Canada regulations, this radio transmitter may only operate using an antenna of a type and maximum (or lesser) gain approved for the transmitter by Industry Canada. To reduce potential radio interference to other users, the antenna type and its gain should be so chosen that the equivalent isotropically radiated power (e.i.r.p.) is not more than that necessary for successful communication. This radio transmitter has been approved by Industry Canada to operate with the antenna types listed in the user guide with the maximum permissible gain and required antenna impedance for each antenna type indicated. Antenna types not included in this list, having a gain greater than the maximum gain indicated for that type, are strictly prohibited for use with this device.

Concernant les EVMs avec antennes détachables

Conformément à la réglementation d'Industrie Canada, le présent émetteur radio peut fonctionner avec une antenne d'un type et d'un gain maximal (ou inférieur) approuvé pour l'émetteur par Industrie Canada. Dans le but de réduire les risques de brouillage radioélectrique à l'intention des autres utilisateurs, il faut choisir le type d'antenne et son gain de sorte que la puissance isotrope rayonnée équivalente (p.i.r.e.) ne dépasse pas l'intensité nécessaire à l'établissement d'une communication satisfaisante. Le présent émetteur radio a été approuvé par Industrie Canada pour fonctionner avec les types d'antenne énumérés dans le manuel d'usage et ayant un gain admissible maximal et l'impédance requise pour chaque type d'antenne. Les types d'antenne non inclus dans cette liste, ou dont le gain est supérieur au gain maximal indiqué, sont strictement interdits pour l'exploitation de l'émetteur.

3.3 Japan

3.3.1 *Notice for EVMs delivered in Japan:* Please see http://www.tij.co.jp/lstds/ti_ja/general/eStore/notice_01.page 日本国内に輸入される評価用キット、ボードについては、次のところをご覧ください。
http://www.tij.co.jp/lstds/ti_ja/general/eStore/notice_01.page

3.3.2 *Notice for Users of EVMs Considered "Radio Frequency Products" in Japan:* EVMs entering Japan may not be certified by TI as conforming to Technical Regulations of Radio Law of Japan.

If User uses EVMs in Japan, not certified to Technical Regulations of Radio Law of Japan, User is required by Radio Law of Japan to follow the instructions below with respect to EVMs:

1. Use EVMs in a shielded room or any other test facility as defined in the notification #173 issued by Ministry of Internal Affairs and Communications on March 28, 2006, based on Sub-section 1.1 of Article 6 of the Ministry's Rule for Enforcement of Radio Law of Japan,
2. Use EVMs only after User obtains the license of Test Radio Station as provided in Radio Law of Japan with respect to EVMs, or
3. Use of EVMs only after User obtains the Technical Regulations Conformity Certification as provided in Radio Law of Japan with respect to EVMs. Also, do not transfer EVMs, unless User gives the same notice above to the transferee. Please note that if User does not follow the instructions above, User will be subject to penalties of Radio Law of Japan.

【無線電波を送信する製品の開発キットをお使いになる際の注意事項】 開発キットの中には技術基準適合証明を受けていないものがあります。技術適合証明を受けていないものご使用に際しては、電波法遵守のため、以下のいずれかの措置を取っていただく必要がありますのでご注意ください。

1. 電波法施行規則第6条第1項第1号に基づく平成18年3月28日総務省告示第173号で定められた電波暗室等の試験設備でご使用いただく。
2. 実験局の免許を取得後ご使用いただく。
3. 技術基準適合証明を取得後ご使用いただく。

なお、本製品は、上記の「ご使用にあたっての注意」を譲渡先、移転先に通知しない限り、譲渡、移転できないものとします。

上記を遵守頂けない場合は、電波法の罰則が適用される可能性があることをご留意ください。日本テキサス・インスツルメンツ株式会社
東京都新宿区西新宿 6 丁目 2 4 番 1 号
西新宿三井ビル

3.3.3 *Notice for EVMs for Power Line Communication:* Please see http://www.tij.co.jp/llds/ti_ja/general/eStore/notice_02.page
電力線搬送波通信についての開発キットをお使いになる際の注意事項については、次のところをご覧ください。http://www.tij.co.jp/llds/ti_ja/general/eStore/notice_02.page

4 *EVM Use Restrictions and Warnings:*

4.1 EVMS ARE NOT FOR USE IN FUNCTIONAL SAFETY AND/OR SAFETY CRITICAL EVALUATIONS, INCLUDING BUT NOT LIMITED TO EVALUATIONS OF LIFE SUPPORT APPLICATIONS.

4.2 User must read and apply the user guide and other available documentation provided by TI regarding the EVM prior to handling or using the EVM, including without limitation any warning or restriction notices. The notices contain important safety information related to, for example, temperatures and voltages.

4.3 *Safety-Related Warnings and Restrictions:*

4.3.1 User shall operate the EVM within TI's recommended specifications and environmental considerations stated in the user guide, other available documentation provided by TI, and any other applicable requirements and employ reasonable and customary safeguards. Exceeding the specified performance ratings and specifications (including but not limited to input and output voltage, current, power, and environmental ranges) for the EVM may cause personal injury or death, or property damage. If there are questions concerning performance ratings and specifications, User should contact a TI field representative prior to connecting interface electronics including input power and intended loads. Any loads applied outside of the specified output range may also result in unintended and/or inaccurate operation and/or possible permanent damage to the EVM and/or interface electronics. Please consult the EVM user guide prior to connecting any load to the EVM output. If there is uncertainty as to the load specification, please contact a TI field representative. During normal operation, even with the inputs and outputs kept within the specified allowable ranges, some circuit components may have elevated case temperatures. These components include but are not limited to linear regulators, switching transistors, pass transistors, current sense resistors, and heat sinks, which can be identified using the information in the associated documentation. When working with the EVM, please be aware that the EVM may become very warm.

4.3.2 EVMs are intended solely for use by technically qualified, professional electronics experts who are familiar with the dangers and application risks associated with handling electrical mechanical components, systems, and subsystems. User assumes all responsibility and liability for proper and safe handling and use of the EVM by User or its employees, affiliates, contractors or designees. User assumes all responsibility and liability to ensure that any interfaces (electronic and/or mechanical) between the EVM and any human body are designed with suitable isolation and means to safely limit accessible leakage currents to minimize the risk of electrical shock hazard. User assumes all responsibility and liability for any improper or unsafe handling or use of the EVM by User or its employees, affiliates, contractors or designees.

4.4 User assumes all responsibility and liability to determine whether the EVM is subject to any applicable international, federal, state, or local laws and regulations related to User's handling and use of the EVM and, if applicable, User assumes all responsibility and liability for compliance in all respects with such laws and regulations. User assumes all responsibility and liability for proper disposal and recycling of the EVM consistent with all applicable international, federal, state, and local requirements.

5. *Accuracy of Information:* To the extent TI provides information on the availability and function of EVMs, TI attempts to be as accurate as possible. However, TI does not warrant the accuracy of EVM descriptions, EVM availability or other information on its websites as accurate, complete, reliable, current, or error-free.

6. *Disclaimers:*
- 6.1 EXCEPT AS SET FORTH ABOVE, EVMS AND ANY WRITTEN DESIGN MATERIALS PROVIDED WITH THE EVM (AND THE DESIGN OF THE EVM ITSELF) ARE PROVIDED "AS IS" AND "WITH ALL FAULTS." TI DISCLAIMS ALL OTHER WARRANTIES, EXPRESS OR IMPLIED, REGARDING SUCH ITEMS, INCLUDING BUT NOT LIMITED TO ANY IMPLIED WARRANTIES OF MERCHANTABILITY OR FITNESS FOR A PARTICULAR PURPOSE OR NON-INFRINGEMENT OF ANY THIRD PARTY PATENTS, COPYRIGHTS, TRADE SECRETS OR OTHER INTELLECTUAL PROPERTY RIGHTS.
- 6.2 EXCEPT FOR THE LIMITED RIGHT TO USE THE EVM SET FORTH HEREIN, NOTHING IN THESE TERMS AND CONDITIONS SHALL BE CONSTRUED AS GRANTING OR CONFERRING ANY RIGHTS BY LICENSE, PATENT, OR ANY OTHER INDUSTRIAL OR INTELLECTUAL PROPERTY RIGHT OF TI, ITS SUPPLIERS/LICENSORS OR ANY OTHER THIRD PARTY, TO USE THE EVM IN ANY FINISHED END-USER OR READY-TO-USE FINAL PRODUCT, OR FOR ANY INVENTION, DISCOVERY OR IMPROVEMENT MADE, CONCEIVED OR ACQUIRED PRIOR TO OR AFTER DELIVERY OF THE EVM.
7. *USER'S INDEMNITY OBLIGATIONS AND REPRESENTATIONS.* USER WILL DEFEND, INDEMNIFY AND HOLD TI, ITS LICENSORS AND THEIR REPRESENTATIVES HARMLESS FROM AND AGAINST ANY AND ALL CLAIMS, DAMAGES, LOSSES, EXPENSES, COSTS AND LIABILITIES (COLLECTIVELY, "CLAIMS") ARISING OUT OF OR IN CONNECTION WITH ANY HANDLING OR USE OF THE EVM THAT IS NOT IN ACCORDANCE WITH THESE TERMS AND CONDITIONS. THIS OBLIGATION SHALL APPLY WHETHER CLAIMS ARISE UNDER STATUTE, REGULATION, OR THE LAW OF TORT, CONTRACT OR ANY OTHER LEGAL THEORY, AND EVEN IF THE EVM FAILS TO PERFORM AS DESCRIBED OR EXPECTED.
8. *Limitations on Damages and Liability:*
- 8.1 *General Limitations.* IN NO EVENT SHALL TI BE LIABLE FOR ANY SPECIAL, COLLATERAL, INDIRECT, PUNITIVE, INCIDENTAL, CONSEQUENTIAL, OR EXEMPLARY DAMAGES IN CONNECTION WITH OR ARISING OUT OF THESE TERMS AND CONDITIONS OR THE USE OF THE EVMS PROVIDED HEREUNDER, REGARDLESS OF WHETHER TI HAS BEEN ADVISED OF THE POSSIBILITY OF SUCH DAMAGES. EXCLUDED DAMAGES INCLUDE, BUT ARE NOT LIMITED TO, COST OF REMOVAL OR REINSTALLATION, ANCILLARY COSTS TO THE PROCUREMENT OF SUBSTITUTE GOODS OR SERVICES, RETESTING, OUTSIDE COMPUTER TIME, LABOR COSTS, LOSS OF GOODWILL, LOSS OF PROFITS, LOSS OF SAVINGS, LOSS OF USE, LOSS OF DATA, OR BUSINESS INTERRUPTION. NO CLAIM, SUIT OR ACTION SHALL BE BROUGHT AGAINST TI MORE THAN ONE YEAR AFTER THE RELATED CAUSE OF ACTION HAS OCCURRED.
- 8.2 *Specific Limitations.* IN NO EVENT SHALL TI'S AGGREGATE LIABILITY FROM ANY WARRANTY OR OTHER OBLIGATION ARISING OUT OF OR IN CONNECTION WITH THESE TERMS AND CONDITIONS, OR ANY USE OF ANY TI EVM PROVIDED HEREUNDER, EXCEED THE TOTAL AMOUNT PAID TO TI FOR THE PARTICULAR UNITS SOLD UNDER THESE TERMS AND CONDITIONS WITH RESPECT TO WHICH LOSSES OR DAMAGES ARE CLAIMED. THE EXISTENCE OF MORE THAN ONE CLAIM AGAINST THE PARTICULAR UNITS SOLD TO USER UNDER THESE TERMS AND CONDITIONS SHALL NOT ENLARGE OR EXTEND THIS LIMIT.
9. *Return Policy.* Except as otherwise provided, TI does not offer any refunds, returns, or exchanges. Furthermore, no return of EVM(s) will be accepted if the package has been opened and no return of the EVM(s) will be accepted if they are damaged or otherwise not in a resalable condition. If User feels it has been incorrectly charged for the EVM(s) it ordered or that delivery violates the applicable order, User should contact TI. All refunds will be made in full within thirty (30) working days from the return of the components(s), excluding any postage or packaging costs.
10. *Governing Law:* These terms and conditions shall be governed by and interpreted in accordance with the laws of the State of Texas, without reference to conflict-of-laws principles. User agrees that non-exclusive jurisdiction for any dispute arising out of or relating to these terms and conditions lies within courts located in the State of Texas and consents to venue in Dallas County, Texas. Notwithstanding the foregoing, any judgment may be enforced in any United States or foreign court, and TI may seek injunctive relief in any United States or foreign court.

Mailing Address: Texas Instruments, Post Office Box 655303, Dallas, Texas 75265
Copyright © 2015, Texas Instruments Incorporated

IMPORTANT NOTICE

Texas Instruments Incorporated and its subsidiaries (TI) reserve the right to make corrections, enhancements, improvements and other changes to its semiconductor products and services per JESD46, latest issue, and to discontinue any product or service per JESD48, latest issue. Buyers should obtain the latest relevant information before placing orders and should verify that such information is current and complete. All semiconductor products (also referred to herein as "components") are sold subject to TI's terms and conditions of sale supplied at the time of order acknowledgment.

TI warrants performance of its components to the specifications applicable at the time of sale, in accordance with the warranty in TI's terms and conditions of sale of semiconductor products. Testing and other quality control techniques are used to the extent TI deems necessary to support this warranty. Except where mandated by applicable law, testing of all parameters of each component is not necessarily performed.

TI assumes no liability for applications assistance or the design of Buyers' products. Buyers are responsible for their products and applications using TI components. To minimize the risks associated with Buyers' products and applications, Buyers should provide adequate design and operating safeguards.

TI does not warrant or represent that any license, either express or implied, is granted under any patent right, copyright, mask work right, or other intellectual property right relating to any combination, machine, or process in which TI components or services are used. Information published by TI regarding third-party products or services does not constitute a license to use such products or services or a warranty or endorsement thereof. Use of such information may require a license from a third party under the patents or other intellectual property of the third party, or a license from TI under the patents or other intellectual property of TI.

Reproduction of significant portions of TI information in TI data books or data sheets is permissible only if reproduction is without alteration and is accompanied by all associated warranties, conditions, limitations, and notices. TI is not responsible or liable for such altered documentation. Information of third parties may be subject to additional restrictions.

Resale of TI components or services with statements different from or beyond the parameters stated by TI for that component or service voids all express and any implied warranties for the associated TI component or service and is an unfair and deceptive business practice. TI is not responsible or liable for any such statements.

Buyer acknowledges and agrees that it is solely responsible for compliance with all legal, regulatory and safety-related requirements concerning its products, and any use of TI components in its applications, notwithstanding any applications-related information or support that may be provided by TI. Buyer represents and agrees that it has all the necessary expertise to create and implement safeguards which anticipate dangerous consequences of failures, monitor failures and their consequences, lessen the likelihood of failures that might cause harm and take appropriate remedial actions. Buyer will fully indemnify TI and its representatives against any damages arising out of the use of any TI components in safety-critical applications.

In some cases, TI components may be promoted specifically to facilitate safety-related applications. With such components, TI's goal is to help enable customers to design and create their own end-product solutions that meet applicable functional safety standards and requirements. Nonetheless, such components are subject to these terms.

No TI components are authorized for use in FDA Class III (or similar life-critical medical equipment) unless authorized officers of the parties have executed a special agreement specifically governing such use.

Only those TI components which TI has specifically designated as military grade or "enhanced plastic" are designed and intended for use in military/aerospace applications or environments. Buyer acknowledges and agrees that any military or aerospace use of TI components which have **not** been so designated is solely at the Buyer's risk, and that Buyer is solely responsible for compliance with all legal and regulatory requirements in connection with such use.

TI has specifically designated certain components as meeting ISO/TS16949 requirements, mainly for automotive use. In any case of use of non-designated products, TI will not be responsible for any failure to meet ISO/TS16949.

Products

Audio	www.ti.com/audio
Amplifiers	amplifier.ti.com
Data Converters	dataconverter.ti.com
DLP® Products	www.dlp.com
DSP	dsp.ti.com
Clocks and Timers	www.ti.com/clocks
Interface	interface.ti.com
Logic	logic.ti.com
Power Mgmt	power.ti.com
Microcontrollers	microcontroller.ti.com
RFID	www.ti-rfid.com
OMAP Applications Processors	www.ti.com/omap
Wireless Connectivity	www.ti.com/wirelessconnectivity

Applications

Automotive and Transportation	www.ti.com/automotive
Communications and Telecom	www.ti.com/communications
Computers and Peripherals	www.ti.com/computers
Consumer Electronics	www.ti.com/consumer-apps
Energy and Lighting	www.ti.com/energy
Industrial	www.ti.com/industrial
Medical	www.ti.com/medical
Security	www.ti.com/security
Space, Avionics and Defense	www.ti.com/space-avionics-defense
Video and Imaging	www.ti.com/video

TI E2E Community

e2e.ti.com