



# 60×60×38 mm

**San Ace 60 9GA type** Low Power Consumption Fan

## General Specifications

- Material ..... Frame: Plastic (Flammability: UL 94V-0), Impeller: Plastic (Flammability: UL 94V-0)
- Expected life ..... See the table below. (L10 life: 90% survival rate for continuous operation in free air at 60°C, rated voltage)
- Motor protection function ..... Locked rotor burnout protection, Reverse polarity protection  
For details, please refer to p. 547.
- Dielectric strength ..... 50/60 Hz, 500 VAC, for 1 minute (between lead wire conductors and frame)
- Insulation resistance ..... 10 MΩ or more with a 500 VDC megger (between lead wire conductors and frame)
- Sound pressure level (SPL) ..... At 1 m away from the air inlet
- Storage temperature ..... -30 to +70°C (Non-condensing)
- Lead wire ..... ⊕Red ⊖Black (Sensor) Yellow (Control) Brown
- Mass ..... 130 g

## Specifications

The models listed below **have ribs and pulse sensors with PWM control function.** For models without ribs, append "1" to the end of model numbers.

Model no.	Rated voltage [V]	Operating voltage range [V]	PWM duty cycle* [%]	Rated current [A]	Rated input [W]	Rated speed [min <sup>-1</sup> ]	Max. airflow [m <sup>3</sup> /min] [CFM]	Max. static pressure [Pa] [inchH <sub>2</sub> O]	SPL [dB (A)]	Operating temperature [°C]	Expected life [h]	
9GA0612P1J03**	12	10.8 to 12.6	100	1.5	18.0	17500	1.75 62	820 3.3	63	-20 to +60	40000/60°C (70000/40°C)	
			20	0.1	1.2	4000	0.4 14	43 0.17	24			
10.8 to 13.2		100	0.95	11.4	14800	1.5 53	600 2.4	59	-20 to +70			
		20	0.1	1.2	4000	0.4 14	43 0.17	24				
		100	0.55	6.6	11500	1.15 40	375 1.5	52				
		-20 to +60	20	0.06	0.72	2600	0.27 9.5	20 0.08	19			
			100	0.95	11.4	14800	1.5 53	675 2.7	59			
			0	0.05	0.6	1480	0.134 4.7	8.3 0.03	16			
9GA0624P1J03**		24	21.6 to 25.2	100	0.75	18.0	17500	1.75 62	820 3.3	63		-20 to +60
				20	0.1	2.4	6200	0.63 22	104 0.42	35		
21.6 to 26.4			100	0.5	12	14800	1.5 53.0	600 2.4	59			
			20	0.06	1.44	5000	0.5 17.7	70 0.28	28			
	-20 to +60											
	-20 to +70											

\* PWM frequency: 25 kHz \*\* Fan does not rotate when PWM duty cycle is 0%.

The following sensor and control options are available for selection.

Differs according to the model. Refer to the table on pp. 570 to 571. Without sensor Pulse sensor Lock sensor

## Airflow - Static Pressure Characteristics / PWM Duty - Speed Characteristics Example

**9GA0612P1J03** With pulse sensor with PWM control function

PWM duty cycle

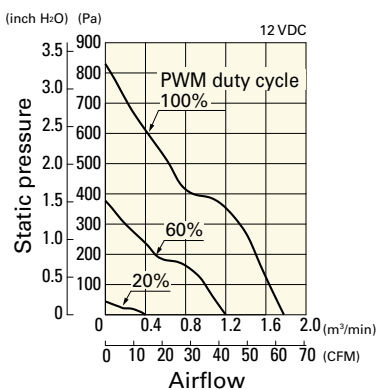

Operating voltage range

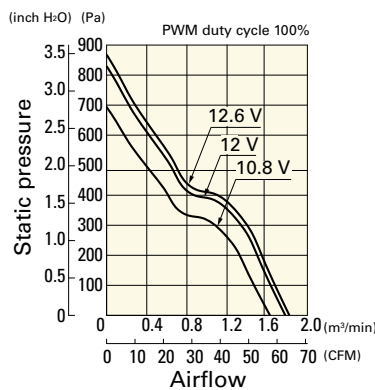

PWM duty - Speed characteristics example

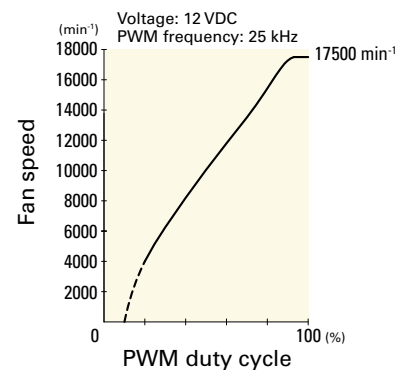

## Airflow - Static Pressure Characteristics / PWM Duty - Speed Characteristics Example

**9GA0612P1K03** With pulse sensor with PWM control function

PWM duty cycle

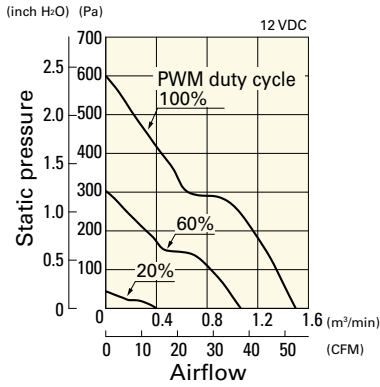

Operating voltage range

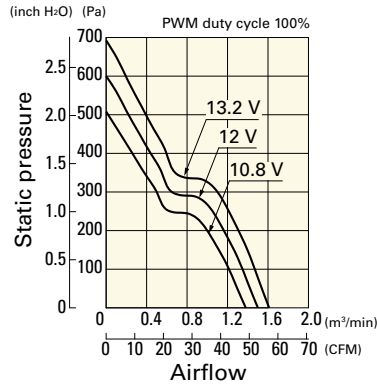

PWM duty - Speed characteristics example

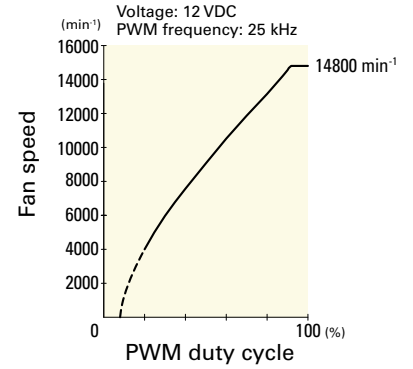

**9GA0612P1H03** With pulse sensor with PWM control function

PWM duty cycle

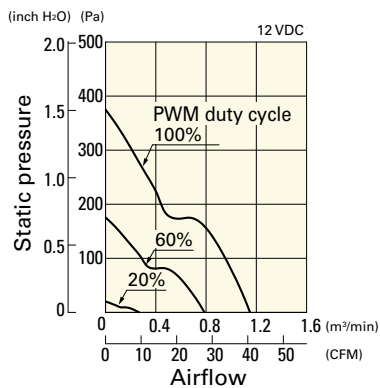

Operating voltage range

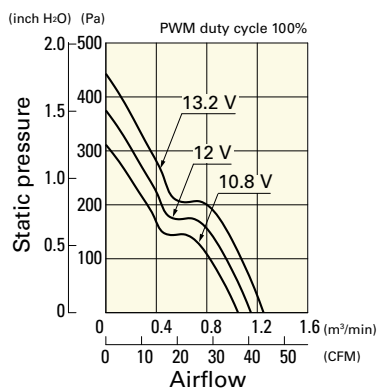

PWM duty - Speed characteristics example

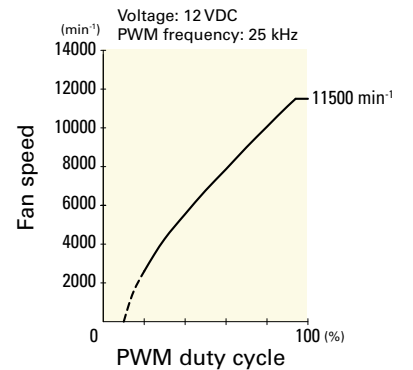

**9GA0612P1K60** With pulse sensor with PWM control function

PWM duty cycle

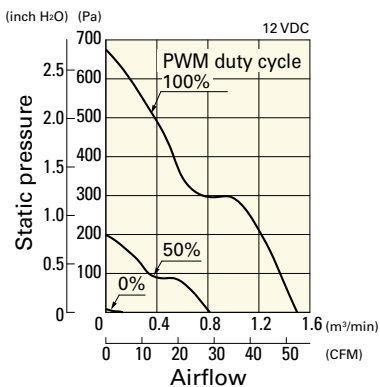

Operating voltage range

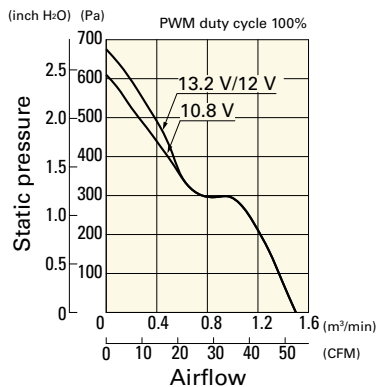

PWM duty - Speed characteristics example

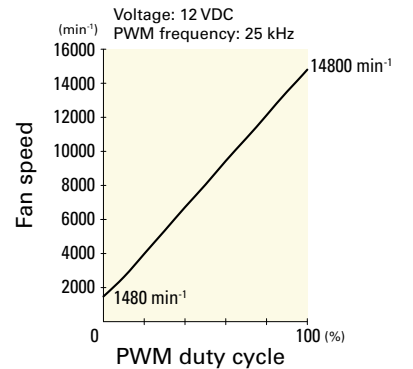

**9GA0624P1J03** With pulse sensor with PWM control function

PWM duty cycle

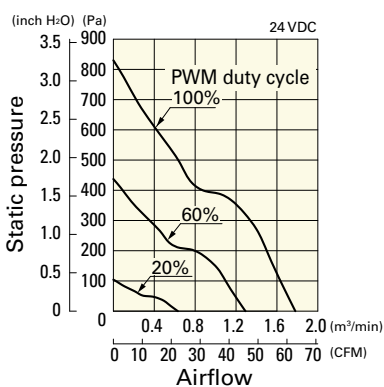

Operating voltage range

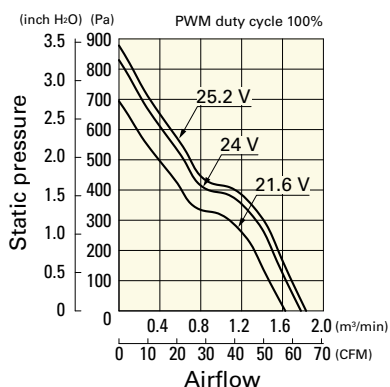

PWM duty - Speed characteristics example

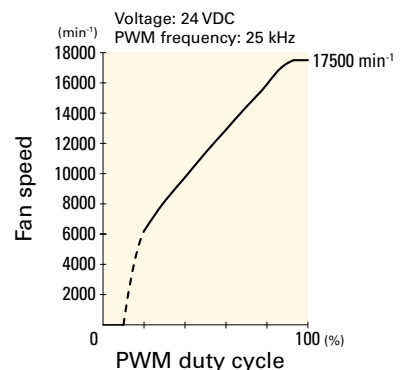

**Airflow - Static Pressure Characteristics / PWM Duty - Speed Characteristics Example**

**9GA0624P1K03** With pulse sensor with PWM control function

PWM duty cycle

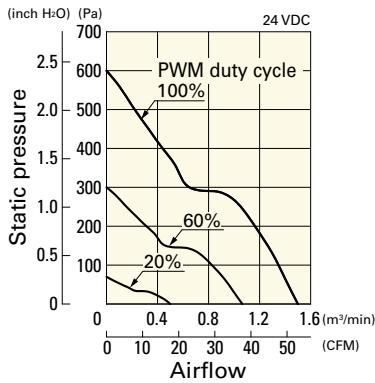

Operating voltage range

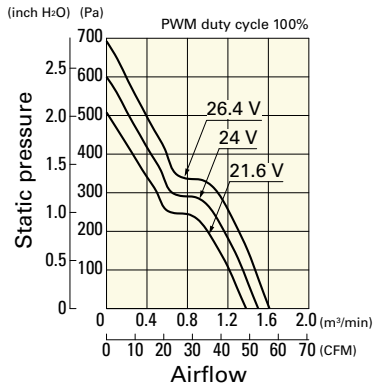

PWM duty - Speed characteristics example

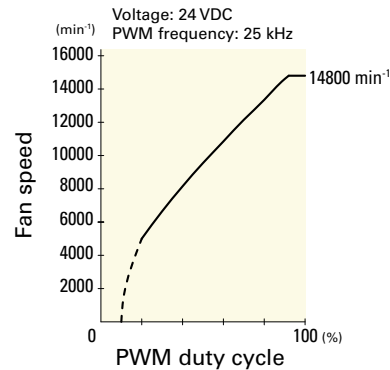

**Dimensions (unit: mm) (With ribs)**

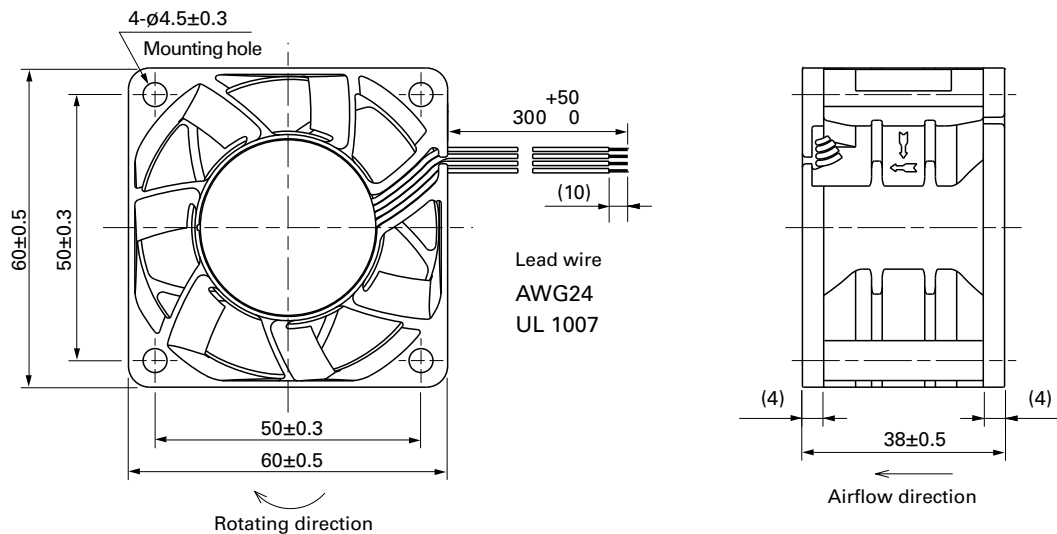

**Reference Dimensions of Mounting Holes and Vent Opening (unit: mm)**

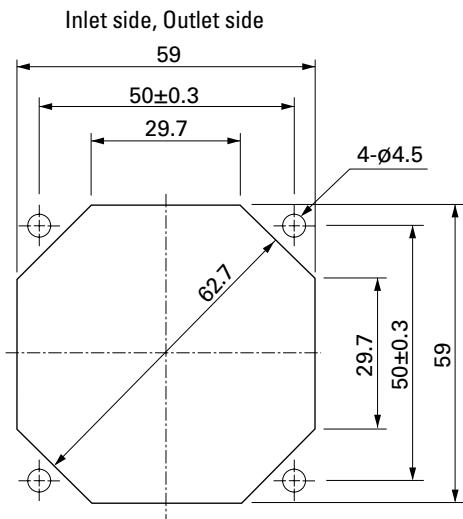

**Options**

**Finger guards** page: p. 532  
Model no.: 109-139E, 109-139H

**Resin finger guards** page: p. 539  
Model no.: 109-1003G

**Resin filter kits** page: p. 540  
Model no.: 109-1003F13 (13PPI), 109-1003F20 (20PPI),  
109-1003F30 (30PPI), 109-1003F40 (40PPI)

# Mouser Electronics

Authorized Distributor

Click to View Pricing, Inventory, Delivery & Lifecycle Information:

## Sanyo Denki:

[9GA0612P1J031](#) [9GA0612P1K031](#) [9GA0612P1H031](#) [9GA0612P1K03](#) [9GA0612P1K601](#) [9GA0612P1H03](#)  
[9GA0612P1J03](#) [9GA0624P1J031](#) [9GA0624P1K03](#) [9GA0624P1K031](#) [9GA0624P1J03](#) [9GA0612P1K60](#)  
[9GA0612J101](#) [9GA0624J101](#) [9GA0624J1011](#) [9GA0612H101](#) [9GA0612H1011](#) [9GA0624J102](#) [9GA0624J1021](#)  
[9GA0612H102](#) [9GA0612H1021](#) [9GA0612J1011](#) [9GA0612J102](#) [9GA0612J1021](#) [9GA0612J1D01](#) [9GA0612K101](#)  
[9GA0612K1011](#) [9GA0612K102](#) [9GA0612K1021](#) [9GA0612K1D011](#) [9GA0612K1D01](#)