

PROPER USE GUIDELINES

Cumulative Trauma Disorders can result from the prolonged use of manually powered hand tools. Hand tools are intended for occasional use and low volume applications. A wide selection of powered application equipment for extended-use, production operations is available.

Crimping Dies for SOLISTRAND Terminals and Splices

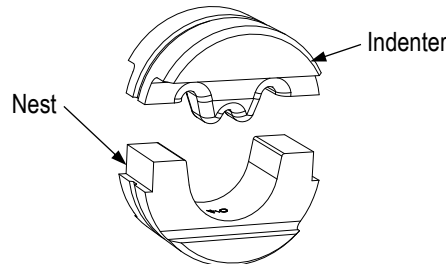

Dies		Nominal Wire Size		Typical Product	Mm ² [CMA Range]	Tool or Head Number
Nest	Indenter	mm ²	AWG			
1490413-1• 1-1490413-4† 3-1490413-3†	1490414-1•	7-8	8	33463 / RTT♦	6.637-10.539 [13,100-20,800]	Head Number 1490745-1 1490746-1† 1490747-1 Hydraulic Hand Tool Number 1490748-1 1490749-1† Hydraulic Battery Tools 2280116-1, -2 2161171-1, -2 2280308-1, -2
1490413-9●	1490414-2●					
1490413-2• 1-1490413-5† 3-1490413-4†	1490414-2•	13-15	6	33466 / RTT♦	10.539-16.771 [20,800-33,100]	
1-1490413-0●	1490414-2●					
1490413-3• 1-1490413-6† 3-1490413-5†	1490414-2•	21	4	34323 / BS△	16.771-26.653 [33,100-52,600]	
1-1490413-1●	1490414-2●					
1490413-4• 1-1490413-7† 3-1490413-6†	1490414-2•	34-35	2	35187 / PS▲	26.653-42.411 [52,600-83,700]	
1-1490413-2●	1490414-3●					
1490413-5• 1-1490413-8† 3-1490413-0†	1490414-3•	59-60	1/0	36946 / PS▲	42.411-60.551 [83,700-119,500]	
1-1490413-3●	1490414-3●					
1490413-6 1-1490413-9† 3-1490413-1†	1490414-3	67-70	2/0	36948 / PS▲	60.551-72.259 [119,500-150,500]	
1490413-7 2-1490413-0† 3-1490413-2†		80-95	3/0	36927 / RTT♦	72.259-96.274 [150,500-190,000]	
1490413-8 2-1490413-1†		100-125	4/0	36932 / RTT♦	96.274-117.049 [190,000-231,000]	

- Also used for STRATO-THERM* Heat Resistant Uninsulated Terminals
- ♦RTT = Ring Tongue Terminals
- △BS = Butt Splice
- ▲PS = Parallel Splice
- Dies for Heavy Duty Terminals
- †90°Bend Terminals

Figure 1

1. INTRODUCTION

This instruction sheet provides application instructions, maintenance, and inspection procedures for the dies listed in Figure 1. These dies crimp SOLISTRAND ring tongue terminals, butt splices, and parallel splices to solid or stranded copper wire (also listed in Figure 1).

The dies are used in Hydraulic Heads 1490745-1, 1490746-1, 1490747-1; Hydraulic Hand Tools 1490748-1, 1490749-1; and Hydraulic Battery Tools 2280116-[], 2161171-[], 2280308-[] (refer to Figure 1 and 2).



NOTE

All dimensions on this document are in metric units [with U. S. customary units in brackets]. Figures and illustrations are for reference only and are not drawn to scale.

Reasons for this revision are given in Section 7, REVISION SUMMARY.

**Tools Using Crimping Dies for SOLISTRAND
Terminals and Splices (Refer to Figure 1)**

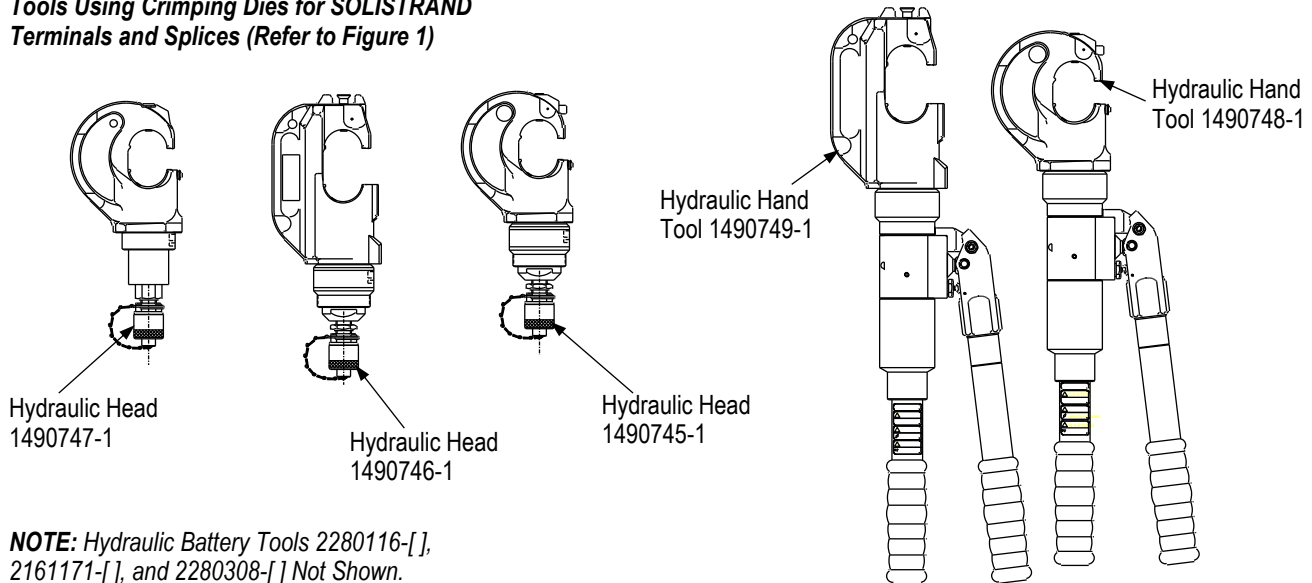

NOTE: Hydraulic Battery Tools 2280116-[], 2161171-[], and 2280308-[] Not Shown.

Figure 2

2. DESCRIPTION

Each die assembly consists of a nest and an indenter (ordered separately) which are retained in the crimping head by retainer pins. The nest is positioned in the yoke of the crimping head, and the indenter is positioned in the ram of the tool.

3. DIE INSTALLATION AND REMOVAL

Determine the correct die assembly, wire size, product number, and tool head to be used (refer to Figure 1).



CAUTION

Never operate the tool with the dies removed.

3.1. Die Installation (Figure 3)



DANGER

To avoid personal injury, be sure to exercise extreme caution when using the power unit. Avoid depressing the footswitch or trigger control when installing or removing dies.

1. Depress the upper die release button located in the “C”-head.
2. Slide the nest into place in “C”-head. See Figure 3.

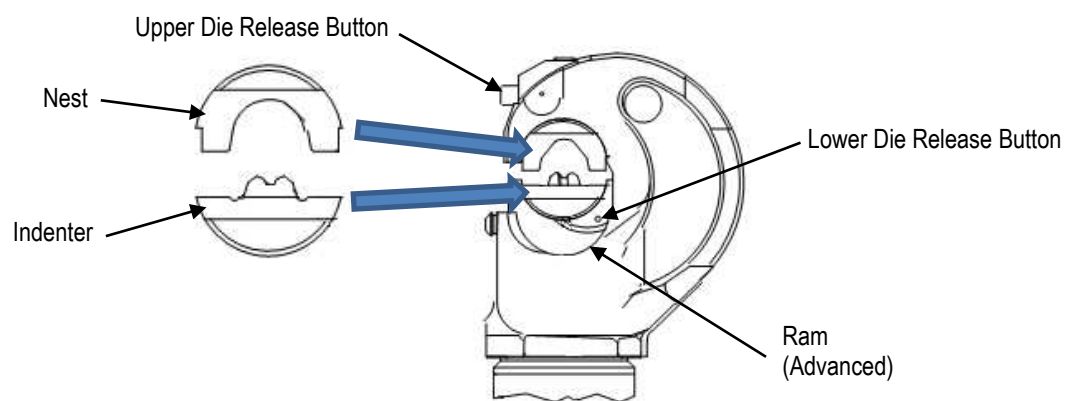

Figure 3

3. Release the button and rock the die back and forth until the nest snaps into position.
4. Activate the power unit until the lower die release button located in the ram is exposed.
5. Depress the release button.
6. Slide the indenter into position in the ram. See Figure 3.
7. Release the button and rock the indenter back and forth until the die snaps into position.
8. Return ram to the down position.

3.2. Die Removal (Figure 3)

1. Depress the upper release button located in the “C”-head and slide the nest out of the head.
2. Activate the power unit until the lower die release button (located in the ram) is exposed.
3. Depress the die release button and slide the indenter out of the ram.

4. WIRE STRIPPING AND CRIMPING PROCEDURES

4.1. Wire Stripping

Strip wire to the dimensions listed in Figure 4. Do NOT nick or cut the wire strands.

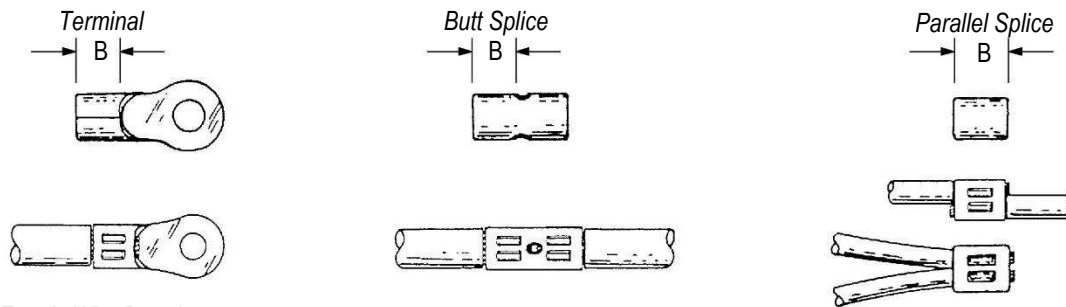

NOTE: "B" Equals Wire Barrel

NOMINAL WIRE SIZE		mm ² [CMA RANGE]	STRIP LENGTHS					
			RING TONGUE TERMINALS		BUTT SPLICES		PARALLEL SPLICES	
mm ²	AWG		MIN	MAX	MIN	MAX	MIN	MAX
7-8	8	6.637-10.539 [13,100-20,800]	8.334 [.328]	9.128 [.359]	10.319 [.406]	11.112 [.437]	10.319 [.406]	11.112 [.437]
13-15	6	10.539-16.771 [20,800-33,100]	9.922 [.391]	13.255 [.522]	11.906 [.469]	12.700 [.500]	11.112 [.437]	11.906 [.469]
21	4	16.771-26.653 [33,100-52,600]	11.509 [.453]	12.302 [.484]	13.493 [.531]	14.288 [.563]	13.493 [.531]	14.288 [.563]
34-35	2	26.653-42.411 [52,600-83,700]	13.096 [.516]	13.890 [.547]	15.081 [.594]	15.875 [.625]	15.081 [.594]	15.875 [.625]
59-60	1/0	42.411-60.551 [83,700-119,500]	18.653 [.734]	20.240 [.797]	15.875 [.625]	17.462 [.687]	17.462 [.687]	19.050 [.750]
67-70	2/0	60.551-72.259 [119,500-150,500]						
80-95	3/0	72.259-96.274 [150,500-190,000]	19.050 [.750]	20.637 [.812]	17.463 [.687]	19.050 [.750]	17.463 [.687]	19.050 [.750]
100-125	4/0	96.274-117.049 [190,000-231,000]	19.446 [.776]	20.637 [.812]	17.463 [.687]	19.050 [.750]	19.050 [.750]	20.637 [.812]

Figure 4

4.2. Crimping Procedure



DANGER

To avoid personal injury, be sure to exercise caution while holding terminals, splices or wire near the crimping area of power units.

1. Ensure that the wire range or size stamped on the terminal or splice corresponds with the wire size being used and the wire range or size stamped on the nest and indenter.
2. Center terminal or splice in nest as shown in Figure 5. For best results, when brazed seam on terminal or splice is visible, position seam toward indenter.
3. Activate power unit so that ram advances and holds terminal or splice in place. Do NOT deform terminal or splice wire barrel.
4. Insert stripped wire into terminal or **parallel splice** until end of conductor is flush with or extended slightly beyond end of wire barrel.
5. Insert stripped wire into **butt splice** until end of conductor butts against splice wire stop.
6. Activate power unit to complete the crimp.



NOTE

If terminal sticks in die after crimping, grasp wire close to crimp and apply a rocking motion to remove from die.

7. If terminal sticks in die after crimping, grasp wire close to crimp and apply a rocking motion to remove from die.
8. Refer to Paragraph 5.1, *Crimp Inspection*, for standard terminal, butt splice, and parallel splice crimp inspection.

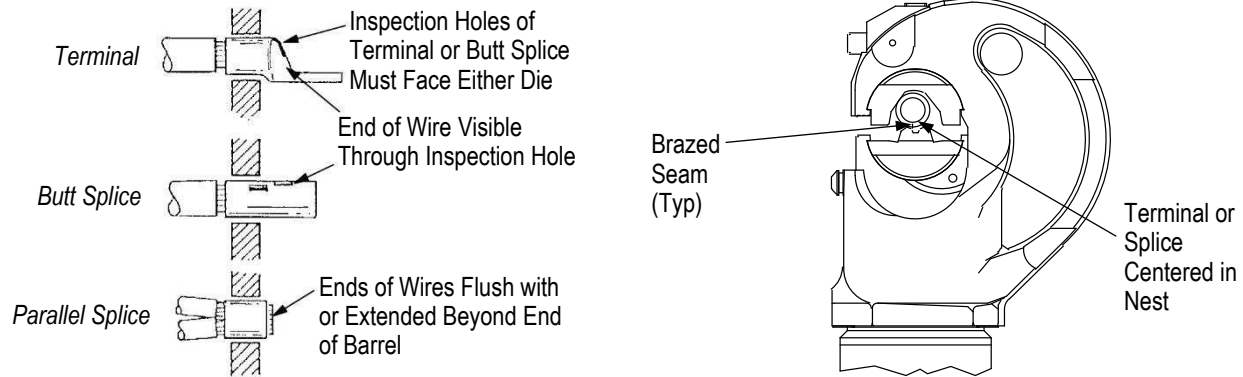

Figure 5

5. INSPECTION/MAINTENANCE



DANGER

To avoid personal injury, disconnect the power supply before performing maintenance, adjustments, inspections and repairs.

5.1. Crimp Inspection (Figure 6)



NOTE

The accompanying procedure is included as an aid to the tool operator ONLY. It is not intended to serve as a quality control procedure for qualifying finished crimps on SOLISTRAND terminals or splices.

Inspect crimped terminals or splices by checking the features described in Figure 6. Use only terminals or splices that meet the conditions shown in the ACCEPT column. Terminals and splices displaying the features shown in the REJECT column can be avoided by careful use of these instructions and by performing the maintenance and inspection procedures described in Paragraphs in 5.2 and 5.3.

5.2. Daily Maintenance

It is recommended that each operator of the dies be made aware of, and responsible for, the following steps of daily maintenance:

1. It is recommended that each operator of the dies be made aware of, and responsible for, the following steps of daily maintenance:
2. If dies are coated with oil or preservative, wipe clean - particularly in the crimping areas - before placing them in use.
3. When dies are not in use, make certain all surfaces are protected with a THIN coat of any good SAE 20 motor oil, and mate and store them in a clean, dry area.

5.3. Periodic Inspection

Regular inspections should be performed by quality control personnel. A record of scheduled inspections should remain with the dies or be made available to supervisory personnel responsible for the dies. Though recommendations call for at least a monthly inspection, the inspection frequency should be based upon the amount of use, working conditions, operator training and skill, and established company standards. These inspections should be performed in the following sequence:

A. Visual Inspection (Figure 7)

1. Remove all lubrication and accumulated film by immersing the dies in a suitable degreaser that will not affect paint or plastic.
2. Check all surfaces for wear. Inspect the crimp area for flattened, chipped, cracked, worn, or broken areas. If damage is evident, the die must be replaced.

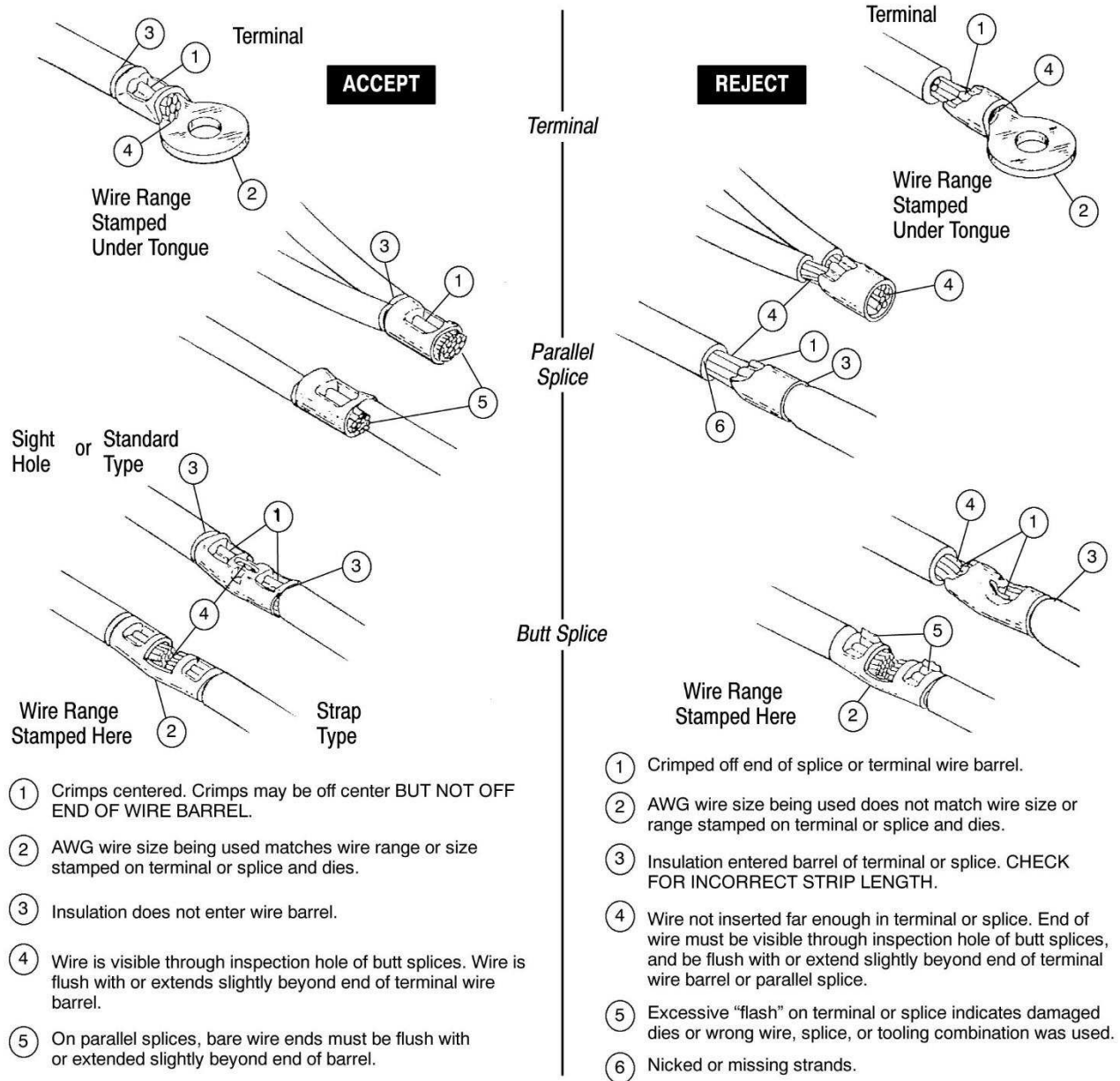

Figure 6

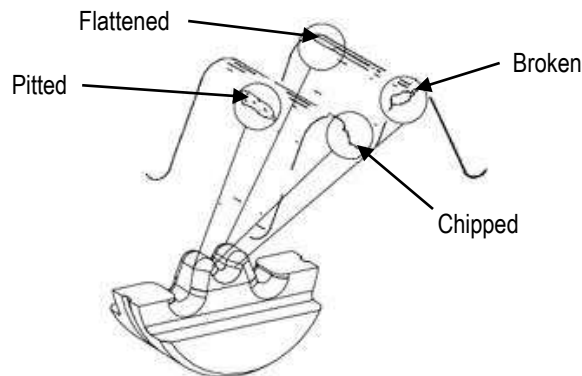

Figure 7

B. Gaging the Crimping Chamber (Figures 8 and 9)

The inspection requires the use of a plug gage conforming to the dimensions in Figure 8.

i **NOTE**
TE Connectivity does not manufacture or market these gages.

Die Closure Configuration

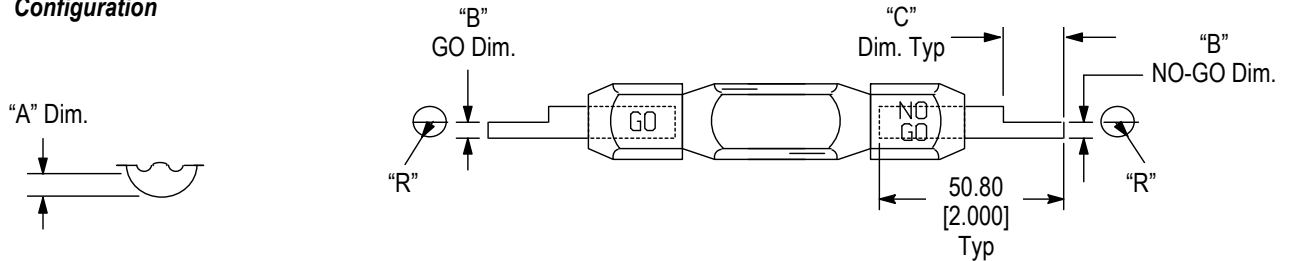

DIES		DIE CLOSURE DIMENSION "A"		GAGE ELEMENT DIMENSIONS "B"		"C" DIMENSION	RADIUS "R"
NEST	INDENTER	GO	NO-GO	GO	NO-GO		
1490413-1 1-1490413-4 3-1490413-3	1490414-1	2.54 [.1000]	2.692 [.1060]	2.54-2.548 [.1000-.1003]	2.689-2.692 [.1059-.1060]	7.92 [.312]	3.18 [.125]
1490413-2 1-1490413-5 3-1490413-4	1490414-2	3.911 [.1540]	4.115 [.1620]	3.911-3.919 [.1540-.1543]	4.112-4.115 [.1619-.1620]	11.09 [.437]	4.34 [.171]
1490413-9	1490414-2						
1490413-3 1-1490413-6 3-1490413-5	1490414-2	4.699 [.1850]	4.902 [.1930]	4.699-4.706 [.1850-.1853]	4.899-4.902 [.1929-.1930]	11.09 [.437]	5.54 [.218]
1-1490413-0	1490414-2						
1490413-4 1-1490413-7 3-1490413-6	1490414-2	5.410 [.2130]	5.613 [.2210]	5.410-5.418 [.2130-.2133]	5.610-5.613 [.2209-.2210]	11.09 [.437]	6.35 [.250]
1-1490413-1	1490414-2						
1490413-5 1-1490413-8 3-1490413-0	1490414-3	6.172 [.2430]	6.375 [.2510]	6.172-6.179 [.2430-.2433]	6.372-6.375 [.2509-.2510]	11.09 [.437]	7.52 [.296]
1-1490413-2							
1490413-6 1-1490413-9 3-1490413-1	1490414-3	6.959 [.2740]	7.163 [.2820]	6.959-6.967 [.2740-.2743]	7.160-7.163 [.2819-.2820]	14.27 [.562]	8.33 [.328]
1-1490413-3							
1490413-7 2-1490413-0 3-1490413-2	1490414-3	7.823 [.3080]	8.026 [.3160]	7.823-7.830 [.3080-.3083]	8.023-8.026 [.3159-.3160]	14.27 [.562]	9.525 [.375]
1490413-8 2-1490413-1	1490414-3						
		8.788 [.3460]	8.991 [.3540]	8.788-8.796 [.3460-.3463]	8.989-8.991 [.3539-.3540]		10.693 [.421]

Figure 8

Proceed as follows:

1. Mate the dies until it is evident that they have bottomed. Hold the dies in this position.
2. Align the GO element with the wire barrel crimping chamber. Push the element straight into the crimping chamber without using force. The GO element must pass completely through the crimping chamber.
3. Align the NO-GO element and try to insert it straight into the same crimping chamber. The NO-GO element may start entry but must not pass completely through. If the crimping chamber conforms to the gage inspection, the dies are considered dimensionally correct. If not, they must be replaced. For additional information regarding the use of a plug gage, refer to Instruction Sheet [408-7424](#).

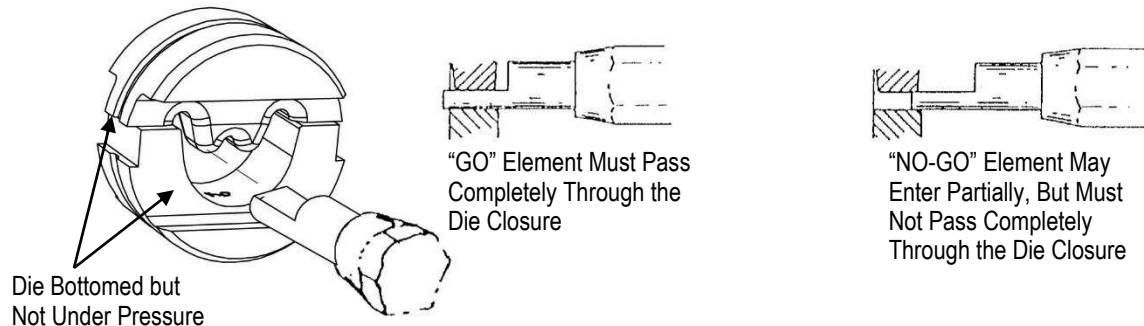

Figure 9

6. REPLACEMENT PARTS

When replacement of a die becomes necessary, contact your local TE representative; call 1-800-526-5142; send a facsimile of your purchase order to 1-717-986-7605; or write to:

CUSTOMER SERVICE (038-035)
 TE CONNECTIVITY CORPORATION
 PO BOX 3608
 HARRISBURG PA 17105-3608

7. REVISION SUMMARY

- In previous Rev [H], header on page 1 said Rev H but footers on all pages after said Rev G. Revised Footers on pages 2-8 to reflect current rev [now H1].