

# LCS Series Small Size Sealed Snap-acting Switches



UL61058-1



## Features/Benefits

- Compact design
- Long life and high electrical capacity
- Quick connect, solder terminals, PC terminals, wire leads
- Wide variety of actuator styles
- RoHS compatible, RoHS compliant
- IP67 for standalone switch except the metal terminal part; Full IP67 protection when potted with wire version

## Typical Applications

- Motorized equipment
- Sump pump
- Thermostatic controls
- Computers
- Air conditioners
- Automotive: door latch, seat position detection, EV charging

## Specifications

CONTACT RATING: from low level to 5 Amp  
 ELECTRICAL LIFE: 10,000 cycles for 5A; 1M cycles for 0.1A  
 INSULATION RESISTANCE: 100 M ohm min.  
 DIELECTRIC STRENGTH: 1,000 VAC  
 OPERATING TEMPERATURE:  
 -40°C to +120°C (without wire)  
 -40°C to +85°C (with UL1007 wire)  
 -40°C to +105°C (with UL1015 wire)  
 -40°C to +105°C (with UL1430 wire)  
 -40°C to +80°C (with UL1061 wire)  
 -40°C to +120°C (with UL1330 wire)  
 OPERATING FORCE: (see ACTUATOR'S option sections).  
 MOUNTING: 2-56 screws, torque 2.3 in/lbs max.

## Materials

SWITCH HOUSING: Thermoplastic polyester or high temperature thermoplastic (PTS) (UL 94V-0).  
 ACTUATOR BUTTON: Thermoplastic polyester.  
 SPRING: Copper alloy.  
 PIVOT: Copper alloy.  
 MOVABLE CONTACTS: Option "01" Gold plating over silver alloy  
 Option "05" Silver alloy  
 STATIONARY CONTACTS: Option "01" Gold plating over silver alloy  
 Option "05" Silver alloy  
 TERMINALS: Copper alloy.  
 ACTUATOR LEVEL: Stainless steel.

**NOTE:** Specifications and materials listed above are for switches with standard options.  
 For information on specific and custom switches, consult Customer Service center.

## Build-A-Switch

To order, simply select desired option from each category and place in the appropriate box. For additional options not shown in catalog, consult Customer Service Center.

<div style="display: flex; align-items: center; gap: 10px;"> <div style="border: 1px solid black; padding: 2px;">L</div> <div style="border: 1px solid black; padding: 2px;">C</div> <div style="border: 1px solid black; padding: 2px;">S</div> <div style="border: 1px solid black; width: 20px; height: 20px;"></div> <div style="border: 1px solid black; width: 20px; height: 20px;"></div> <div style="border: 1px solid black; width: 20px; height: 20px;"></div> <div style="border: 1px solid black; width: 20px; height: 20px;"></div> <div style="border: 1px solid black; width: 20px; height: 20px;"></div> <div style="border: 1px solid black; width: 20px; height: 20px;"></div> <div style="border: 1px solid black; width: 20px; height: 20px;"></div> <div style="border: 1px solid black; width: 20px; height: 20px;"></div> <div style="border: 1px solid black; width: 20px; height: 20px;"></div> </div>																	
<p><b>Series</b> LCS</p>			<p><b>Operating Force</b> 2 203 grams</p>			<p><b>Circuitry</b> C SPDT W SPST N.C. Y SPST N.O.</p>											
<p><b>Electrical Rating</b></p> <table border="1"> <thead> <tr> <th>Option Code</th> <th>UL 61058-1</th> <th>UL 61058-1</th> </tr> </thead> <tbody> <tr> <td>01</td> <td>0.1 A 125/250 V AC</td> <td>NA</td> </tr> <tr> <td>05</td> <td>5 A 125/250 V AC</td> <td>6 A 250 V AC</td> </tr> </tbody> </table>			Option Code	UL 61058-1	UL 61058-1	01	0.1 A 125/250 V AC	NA	05	5 A 125/250 V AC	6 A 250 V AC	<p><b>Actuator</b>                  P00 Pin plunger                  T00 11.9 mm short lever                  T05 17.4 mm short lever                  T07 19.4 mm short lever                  T13 25.5 mm lever                  T19 33.3 mm lever                  T28 40.7 mm lever                  T43 55.9 mm lever                  S26 18.6 mm simulated lever                  A05 17.2 mm lever roller</p>			<p><b>Terminations</b>                  S Solder                  Q 0.110 Quick Connect                  P PC Thru Hole                  W Wire leads potted                  Z Wire leads non-potted</p>		
Option Code	UL 61058-1	UL 61058-1															
01	0.1 A 125/250 V AC	NA															
05	5 A 125/250 V AC	6 A 250 V AC															
			<p><b>Wire Type AWG (when required)</b>                  20 20 AWG                  22 22 AWG                  24 24 AWG                  26 26 AWG</p>			<p><b>Wire UL # (when required)</b>                  A UL1007                  B UL1015                  C UL1430                  D UL1061</p>											
			<p><b>Wire Side (when required)</b>                  A Wire out the bottom                  B Wire out the right side                  C Wire out the left side                  D None</p>														



Snap-acting

# LCS Series Small Size Sealed Snap-acting Switches

## SERIES

### LCS

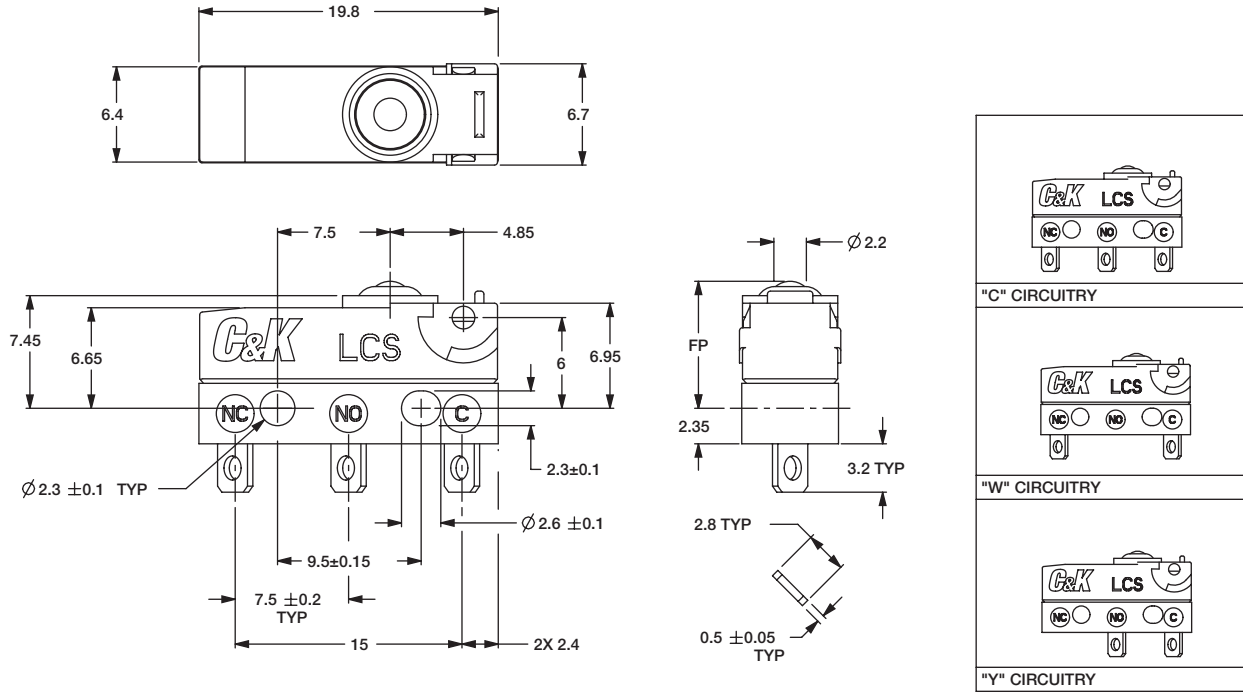

Snap-acting

## ELECTRICAL RATING

RoHS COMPLIANT *	RoHS COMPATIBLE *	OPTION CODE	ELECTRICAL RATING
YES	YES	<b>05</b>	5 AMP, 125/250 V AC
YES	YES	<b>01</b>	0.1 AMP, 125/250 V AC

## OPERATING FORCE

OPTION CODE	OPERATING FORCES (grams)
<b>2</b>	203 g. max.

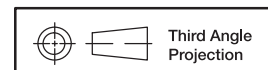

Third Angle Projection  
Dimensions are shown: mm  
Specifications and dimensions subject to change



# LCS Series Small Size Sealed Snap-acting Switches

## ACTUATOR

P00

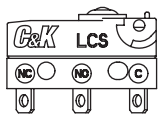

T19

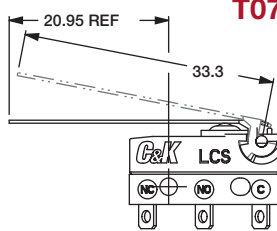

T07

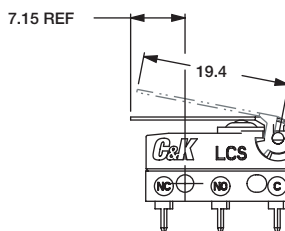

A05

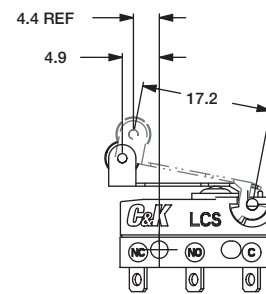

T00

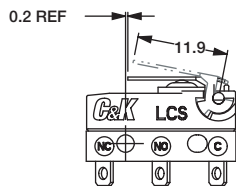

T28

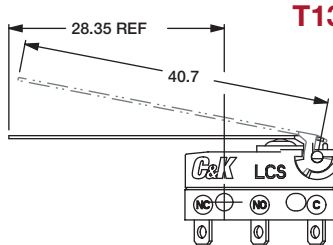

T13

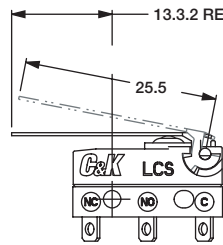

S26

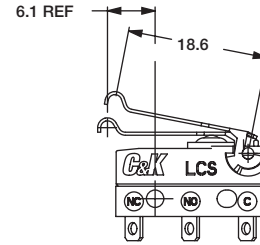

T05

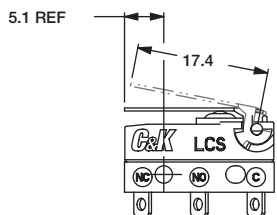

T43

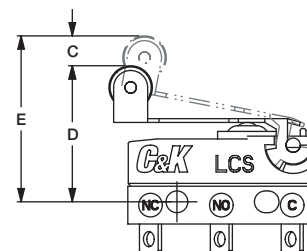
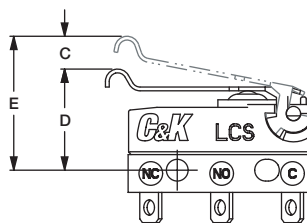
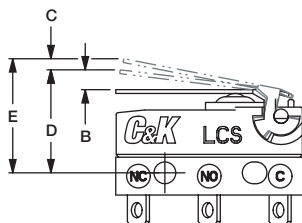
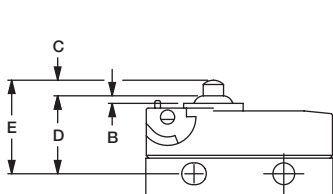
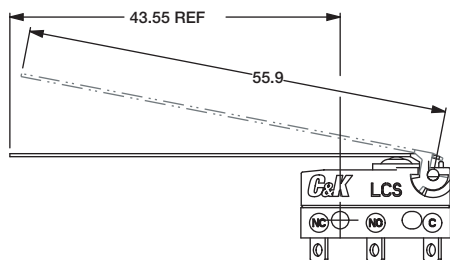

ACTUATOR OPTION CODE	A LENGTH OF LEVER	B OVER TRAVEL (MIN)	C PRE TRAVEL (MAX)	D OPERATING POSITION	E FREE POSITION (MAX)	DIFFERENTIAL MOTION (MAX)	OPERATING FORCE (MAX)	RELEASE FORCE (MIN)
						203	203	203
P00	N/A	0.6	1.2	8.4 ± 3	9.9	0.2	203	50
T00	11.9	0.6	3.2	8.8 ± 9	11.1	0.5	98	21
T05	17.40	0.9	4.3	8.8 ± 1.1	12	0.6	82	16
T07	19.40	1	4.8	8.8 ± 1.2	12.4	0.7	66	13
T13	25.5	1.6	6.3	8.8 ± 1.6	13.5	0.9	54	11
T19	33.3	1.95	8	8.8 ± 2.0	15	1.75	40	5
T28	40.7	2.1	10.1	8.8 ± 2.6	16.3	2.3	39	8
T43	55.9	2.9	13.8	8.8 ± 3.5	19.1	3.6	33	7
S26	18.6	1	4.6	10.7 ± 1.2	14.1	0.65	68	14
A05	17.20	0.9	4.3	14.5 ± 1.1	17.7	0.6	72	15

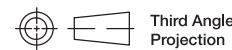

Third Angle Projection

Dimensions are shown: mm  
Specifications and dimensions subject to change



# LCS Series Small Size Sealed Snap-acting Switches

## TERMINATIONS

### S SOLDER

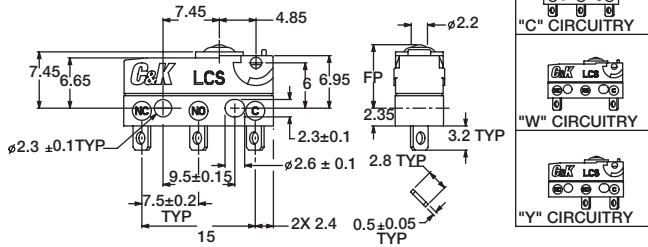

### Q QUICK CONNECT 2.8mm / 0.110"

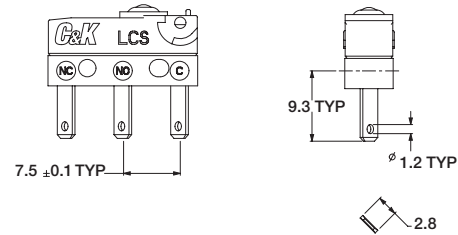

### P PC THRU HOLE

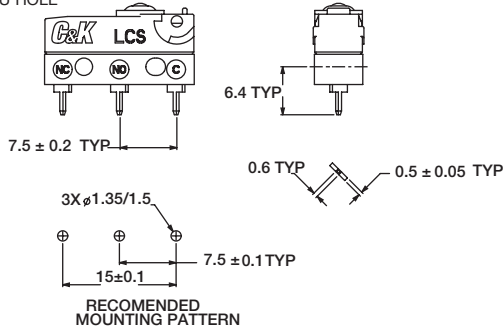

### Z or W "A" WIRE ORIENTATION

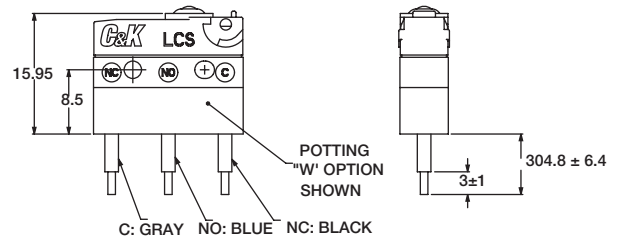

### Z or W "B" WIRE ORIENTATION "Y" OR "W" CIRCUITRY

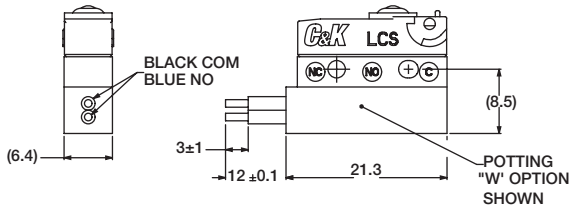

### Z or W "C" WIRE ORIENTATION "Y" OR "W" CIRCUITRY

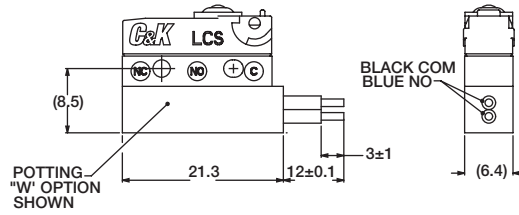

### Z or W "B" WIRE ORIENTATION "C" CIRCUITRY

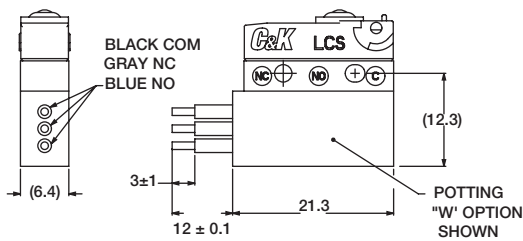

### Z or W "C" WIRE ORIENTATION "C" CIRCUITRY

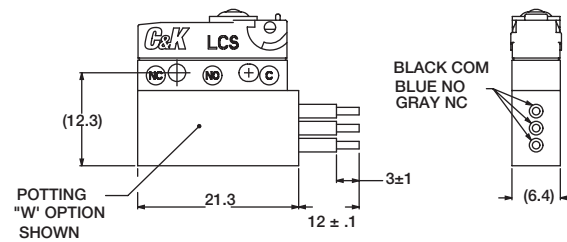

Snap-acting

## CIRCUITRY

- C** SPDT (Single Pole, Double Throw)
- W** SPST N.C. (Single Pole, Single Throw, Normally Closed)
- Y** SPST N.O. (Single Pole, Single Throw, Normally Open)



Dimensions are shown: mm  
Specifications and dimensions subject to change

