



## 16-Bit, Dual, Parallel Input, Multiplying Digital-to-Analog Converter

### FEATURES

- $\pm 0.5\text{LSB DNL}$
- $\pm 1\text{LSB INL}$
- **Low Noise:**  $12\text{nV}/\sqrt{\text{Hz}}$
- **Low Power Operation:**  
 $I_{\text{DD}} = 1\mu\text{A per Channel at } 2.7\text{V}$
- **2mA Full-Scale Current, with  $V_{\text{REF}} = 10\text{V}$**
- **Settling Time:**  $0.5\mu\text{s}$
- **16-Bit Monotonic**
- **4-Quadrant Multiplying Reference Inputs**
- **Reference Bandwidth:**  $10\text{MHz}$
- **Reference Input:**  $\pm 18\text{V}$
- **Reference Dynamics:**  $-105\text{ THD}$
- **Midscale or Zero Scale Reset**
- **Analog Power Supply:**  $+2.7\text{V to } +5.5\text{V}$
- **TSSOP-38 Package**
- **Industry-Standard Pin Configuration**
- **Pin-Compatible with the 14-Bit [DAC8805](#)**
- **Temperature Range:**  $-40^{\circ}\text{C to } +125^{\circ}\text{C}$

### APPLICATIONS

- **Automatic Test Equipment**
- **Instrumentation**
- **Digitally Controlled Calibration**
- **Industrial Control PLCs**

### DESCRIPTION

The DAC8822 dual, multiplying digital-to-analog converter (DAC) is designed to operate from a single 2.7V to 5.5V supply.

The applied external reference input voltage  $V_{\text{REF}}$  determines the full-scale output current. An internal feedback resistor ( $R_{\text{FB}}$ ) provides temperature tracking for the full-scale output when combined with an external, current-to-voltage (I/V) precision amplifier.

A RSTSEL pin allows system reset assertion ( $\overline{\text{RS}}$ ) to force all registers to zero code when RSTSEL = '0', or to midscale code when RSTSEL = '1'. Additionally, an internal power-on reset forces all registers to zero or midscale code at power-up, depending on the state of the RSTSEL pin.

A parallel interface offers high-speed communications. The DAC8822 is packaged in a space-saving TSSOP-38 package and has an industry-standard pinout. The device is specified from  $-40^{\circ}\text{C}$  to  $+125^{\circ}\text{C}$ .

For a 14-bit, pin-compatible version, see the [DAC8805](#).

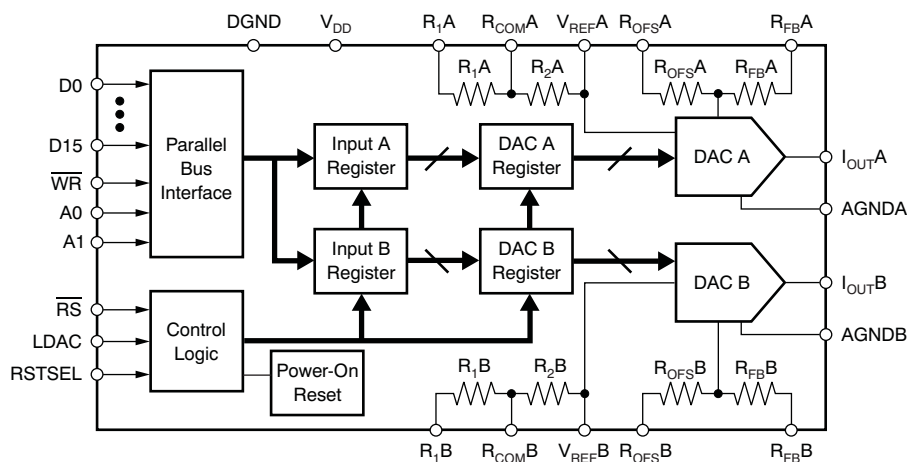

Please be aware that an important notice concerning availability, standard warranty, and use in critical applications of Texas Instruments semiconductor products and disclaimers thereto appears at the end of this data sheet.

All trademarks are the property of their respective owners.



This integrated circuit can be damaged by ESD. Texas Instruments recommends that all integrated circuits be handled with appropriate precautions. Failure to observe proper handling and installation procedures can cause damage.

ESD damage can range from subtle performance degradation to complete device failure. Precision integrated circuits may be more susceptible to damage because very small parametric changes could cause the device not to meet its published specifications.

### ORDERING INFORMATION<sup>(1)</sup>

PRODUCT	RELATIVE ACCURACY (LSB)	DIFFERENTIAL NONLINEARITY (LSB)	PACKAGE-LEAD (DESIGNATOR)	SPECIFIED TEMPERATURE RANGE	PACKAGE MARKING
DAC8822QB	±2	±1	TSSOP-38 (DBT)	–40°C to +125°C	DAC8822
DAC8822QC	±1	±1	TSSOP-38 (DBT)	–40°C to +125°C	DAC8822

(1) For the most current package and ordering information see the Package Option Addendum at the end of this document, or see the TI web site at [www.ti.com](http://www.ti.com).

### ABSOLUTE MAXIMUM RATINGS

over operating free-air temperature range (unless otherwise noted)<sup>(1)</sup>

	DAC8822	UNIT
V <sub>DD</sub> to GND	–0.3 to +7	V
Digital input voltage to GND	–0.3 to +V <sub>DD</sub> + 0.3	V
V (I <sub>OUT</sub> ) to GND	–0.3 to +V <sub>DD</sub> + 0.3	V
REF, R <sub>OFS</sub> , R <sub>FB</sub> , R <sub>1</sub> , R <sub>COM</sub> to AGND, DGND	±25	V
Operating temperature range	–40 to +125	°C
Storage temperature range	–65 to +150	°C
Junction temperature range (T <sub>J</sub> max)	+150	°C
Power dissipation	(T <sub>J</sub> max – T <sub>A</sub> ) / R <sub>θJA</sub>	W
Thermal impedance, R <sub>θJA</sub>	53	°C/W
ESD rating	Human Body Model (HBM)	4000
	Charged Device Model (CDM)	500

(1) Stresses above those listed under *Absolute Maximum Ratings* may cause permanent damage to the device. Exposure to absolute maximum conditions for extended periods may affect device reliability.

**ELECTRICAL CHARACTERISTICS**

 All specifications at  $T_A = -40^\circ\text{C}$  to  $+125^\circ\text{C}$ ,  $V_{DD} = +2.7\text{V}$  to  $+5.5\text{V}$ ,  $I_{OUT} = \text{virtual GND}$ ,  $\text{GND} = 0\text{V}$ , and  $V_{REF} = 10\text{V}$ , unless otherwise noted.

PARAMETER	CONDITIONS	DAC8822			UNITS		
		MIN	TYP	MAX			
<b>STATIC PERFORMANCE</b>							
Resolution		16			Bits		
Relative accuracy	INL	DAC8822QB			±2	LSB	
		DAC8822QC			±1	LSB	
Differential nonlinearity	DNL			±0.5	±1	LSB	
Output leakage current	Data = 0000h, $T_A = +25^\circ\text{C}$			10	nA		
Output leakage current	Data = 0000h, Full temperature range			20	nA		
Full-scale gain error	Unipolar, data = FFFFh			±1	±4	mV	
	Bipolar, data = FFFFh			±1	±4	mV	
Full-scale temperature coefficient				±1	±2	ppm/°C	
Bipolar zero error	$T_A = +25^\circ\text{C}$			±1	±3	mV	
	Full temperature range			±1	±3	mV	
Power-supply rejection ratio	PSRR $V_{DD} = 5\text{V} \pm 10\%$			±0.2	±1.0	LSB/V	
<b>OUTPUT CHARACTERISTICS<sup>(1)</sup></b>							
Output current				2	mA		
Output capacitance	Code dependent			50	pF		
<b>REFERENCE INPUT</b>							
Reference voltage range	$V_{REF}$			-18	18	V	
Input resistance (unipolar)	$R_{REF}$	4	5	6	kΩ		
Input capacitance				5	pF		
$R_1, R_2$		4	5	6	kΩ		
Feedback and offset resistance	$R_{OFS}, R_{FB}$	8	10	12	kΩ		
<b>LOGIC INPUTS AND OUTPUT<sup>(1)</sup></b>							
Input low voltage	$V_{IL}$	$V_{DD} = +2.7\text{V}$			0.6	V	
	$V_{IL}$	$V_{DD} = +5\text{V}$			0.8	V	
Input high voltage	$V_{IH}$	$V_{DD} = +2.7\text{V}$	2.1			V	
	$V_{IH}$	$V_{DD} = +5\text{V}$	2.4			V	
Input leakage current	$I_{IL}$			0.001	1	μA	
Input capacitance	$C_{IL}$				8	pF	
<b>POWER REQUIREMENTS</b>							
Supply voltage	$V_{DD}$			2.7	5.5	V	
Supply current	$I_{DD}$	Normal operation, logic inputs = 0V			3	6	μA
		$V_{DD} = +4.5\text{V}$ to $+5.5\text{V}$ , $V_{IH} = V_{DD}$ and $V_{IL} = \text{GND}$			3	6	μA
		$V_{DD} = +2.7\text{V}$ to $+3.6\text{V}$ , $V_{IH} = V_{DD}$ and $V_{IL} = \text{GND}$			1	3	μA
<b>AC CHARACTERISTICS<sup>(1)(2)</sup></b>							
Output current settling time	$t_s$	To 0.0015% of full-scale, data = 0000h to FFFFh to 0000h			0.5	μs	
Reference multiplying BW	BW - 3dB	$V_{REF} = 5V_{PP}$ , data = FFFFh, 2-quadrant mode			10	MHz	
DAC glitch impulse		$V_{REF} = 0\text{V}$ to $10\text{V}$ , data = 7FFFh to 8000h to 7FFFh			5	nV-s	
Feedthrough error	$V_{OUT}/V_{REF}$	Data = 0000h, $V_{REF} = 100\text{kHz}$ , $\pm 10V_{PP}$ , 2-quadrant mode			-70	dB	
Crosstalk error	$V_{OUT}/V_{REFB}$	Data = 0000h, $V_{REFB} = 100mV_{RMS}$ , $f = 100\text{kHz}$			-100	dB	
Digital feedthrough		LDAC = logic low, $V_{REF} = -10\text{V}$ to $+10\text{V}$ Any code change			1	nV-s	
Total harmonic distortion	THD	$V_{REF} = 6V_{RMS}$ , data = FFFFh, $f = 1\text{kHz}$			-105	dB	
Output noise density	$e_n$	$f = 1\text{kHz}$ , BW = 1Hz, 2-quadrant mode			12	nV/√Hz	

(1) Specified by design and characterization; not production tested.

(2) All ac characteristic tests are performed in a closed-loop system using a THS4011 I-to-V converter amplifier.

**PIN ASSIGNMENTS**

**DBT PACKAGE  
TSSOP-38  
(TOP VIEW)**

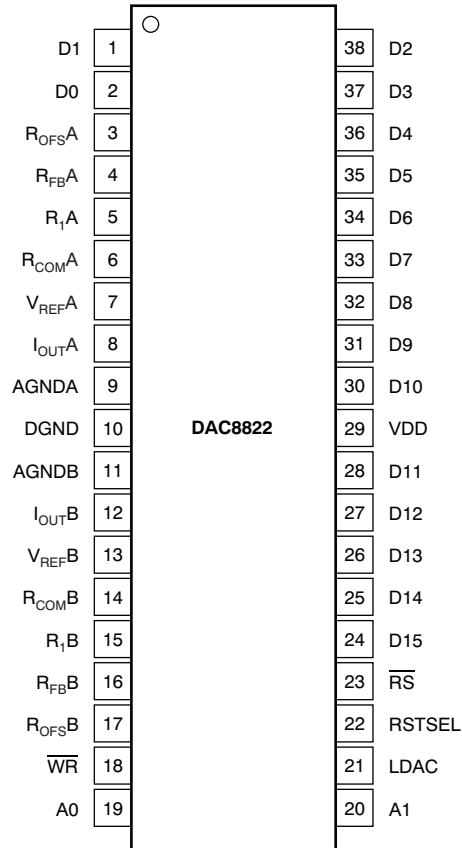

**PIN ASSIGNMENTS (continued)**

**Table 1. TERMINAL FUNCTIONS**

PIN #	NAME	DESCRIPTION
1, 2, 24-28, 30-38	D0-D15	Digital Input Data Bits D0 to D15. Signal level must be $\leq V_{DD} + 0.3V$ . D15 is MSB.
3	R <sub>OFFS</sub> A	Bipolar Offset Resistor A. Accepts up to $\pm 18V$ . In 2-quadrant mode, R <sub>OFFS</sub> A ties to R <sub>FB</sub> A. In 4-quadrant mode, R <sub>OFFS</sub> A ties to R <sub>1</sub> A and the external reference.
4	R <sub>FB</sub> A	Internal Matching Feedback Resistor A. Connects to the external op amp for I-V conversion.
5	R <sub>1</sub> A	4-Quadrant Resistor. In 2-quadrant mode, R <sub>1</sub> A shorts to the V <sub>REF</sub> A pin. In 4-quadrant mode, R <sub>1</sub> A ties to R <sub>OFFS</sub> A and the reference input.
6	R <sub>COM</sub> A	Center Tap Point of the Two 4-Quadrant Resistors, R <sub>1</sub> A and R <sub>2</sub> A. In 2-quadrant mode, R <sub>COM</sub> A shorts to the V <sub>REF</sub> pin. In 4-quadrant mode, R <sub>COM</sub> A ties to the inverting node of the reference amplifier.
7	V <sub>REF</sub> A	DAC A Reference Input in 2-Quadrant Mode, R <sub>2</sub> Terminal in 4-Quadrant Mode. In 2-quadrant mode, V <sub>REF</sub> A is the reference input with constant input resistance versus code. In 4-quadrant mode, V <sub>REF</sub> A is driven by the external reference amplifier.
8	I <sub>OUT</sub> A	DAC A Current Output. Connects to the inverting terminal of external precision I-V op amp for voltage output.
9	AGNDA	DAC A Analog Ground.
10	DGND	Digital Ground.
11	AGNDB	DAC B Analog Ground.
12	I <sub>OUT</sub> B	DAC B Current Output. Connects to the inverting terminal of external precision I-V op amp for voltage output.
13	V <sub>REF</sub> B	DAC B Reference Input in 2-Quadrant Mode, R <sub>2</sub> Terminal in 4-Quadrant Mode. In 2-quadrant mode, V <sub>REF</sub> B is the reference input with constant input resistance versus code. In 4-quadrant mode, V <sub>REF</sub> B is driven by the external reference amplifier.
14	R <sub>COM</sub> B	Center Tap Point of the Two 4-Quadrant Resistors, R <sub>1</sub> B and R <sub>2</sub> B. In 2-quadrant mode, R <sub>COM</sub> B shorts to the V <sub>REF</sub> pin. In 4-quadrant mode, R <sub>COM</sub> B ties to the inverting node of the reference amplifier.
15	R <sub>1</sub> B	4-Quadrant Resistor. In 2-quadrant mode, R <sub>1</sub> B shorts to the V <sub>REF</sub> B pin. In 4-quadrant mode, R <sub>1</sub> B ties to R <sub>OFFS</sub> B and the reference input.
16	R <sub>FB</sub> B	Internal Matching Feedback Resistor B. Connects to external op amp for I-V conversion.
17	R <sub>OFFS</sub> B	Bipolar Offset Resistor B. Accepts up to $\pm 18V$ . In 2-quadrant mode, R <sub>OFFS</sub> B ties to R <sub>FB</sub> B. In 4-quadrant mode, R <sub>OFFS</sub> B ties to R <sub>1</sub> B and the external reference.
18	$\overline{WR}$	Write Control Digital Input In, Active Low. $\overline{WR}$ enables input registers. Signal level must be $\leq V_{DD} + 0.3V$ .
19	A0	Address 0. Signal level must be $\leq V_{DD} + 0.3V$ .
20	A1	Address 1. Signal level must be $\leq V_{DD} + 0.3V$ .
21	LDAC	Digital Input Load DAC Control. Signal level must be $\leq V_{DD} + 0.3V$ . See the <a href="#">Function of Control Inputs</a> table for details.
22	RSTSEL	Power-On Reset State. RSTSEL = 0 corresponds to zero-scale reset. RSTSEL = 1 corresponds to midscale reset. The signal level must be $\leq V_{DD} + 0.3V$ .
23	$\overline{RS}$	Reset. Active low resets both input and DAC registers. Resets to zero-scale if RSTSEL= 0, and to midscale if RSTSEL = 1. Signal level must be equal to or less than VDD + 0.3 V.
29	V <sub>DD</sub>	Positive Power Supply Input. The specified range of operation is 2.7V to 5.5V.

**TIMING AND FUNCTIONAL INFORMATION**

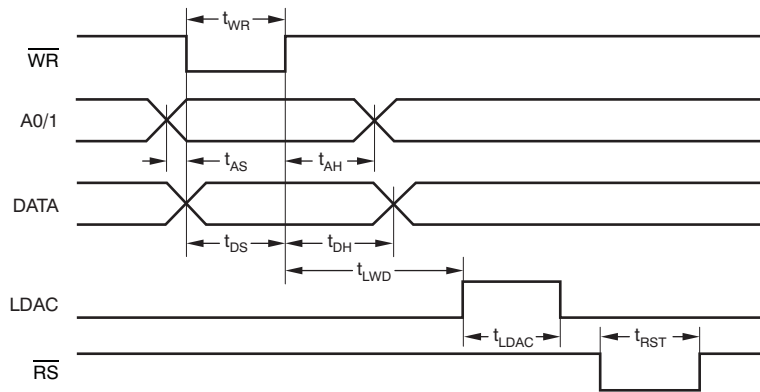

**Figure 1. Timing Diagram**

**TIMING CHARACTERISTICS**



All specifications at  $T_A = -40^\circ\text{C}$  to  $+125^\circ\text{C}$ ,  $I_{OUT} = \text{virtual GND}$ ,  $\text{GND} = 0\text{V}$ , and  $V_{REF} = 10\text{V}$ , unless otherwise noted

PARAMETER	CONDITIONS	DAC8822			UNITS
		MIN	TYP	MAX	
Data to $\overline{WR}$ setup time	$V_{DD} = +5.0\text{V}$	10			ns
	$V_{DD} = +2.7\text{V}$	10			ns
A0/1 to $\overline{WR}$ setup time	$V_{DD} = +5.0\text{V}$	10			ns
	$V_{DD} = +2.7\text{V}$	10			ns
Data to $\overline{WR}$ hold time	$V_{DD} = +5.0\text{V}$	0			ns
	$V_{DD} = +2.7\text{V}$	0			ns
A0/1 to $\overline{WR}$ hold time	$V_{DD} = +5.0\text{V}$	0			ns
	$V_{DD} = +2.7\text{V}$	0			ns
$\overline{WR}$ pulse width	$V_{DD} = +5.0\text{V}$	10			ns
	$V_{DD} = +2.7\text{V}$	10			ns
LDAC pulse width	$V_{DD} = +5.0\text{V}$	10			ns
	$V_{DD} = +2.7\text{V}$	10			ns
$\overline{RS}$ pulse width	$V_{DD} = +5.0\text{V}$	10			ns
	$V_{DD} = +2.7\text{V}$	10			ns
$\overline{WR}$ to LDAC delay time	$V_{DD} = +5.0\text{V}$	0			ns
	$V_{DD} = +2.7\text{V}$	0			ns

**Table 2. Address Decoder Pins**

A1	A0	OUTPUT UPDATE
0	0	DAC A
0	1	None
1	0	DAC A and DAC B
1	1	DAC B

**Table 3. Function of Control Inputs**

CONTROL INPUTS			REGISTER OPERATION
$\overline{RS}$	$\overline{WR}$	LDAC	
0	X	X	Asynchronous operation. Reset the input and DAC register to '0' when the RSTSEL pin is tied to DGND, and to midscale when RSTSEL is tied to $V_{DD}$ .
1	0	0	Load the input register with all 16 data bits.
1	1	1	Load the DAC register with the contents of the input register.
1	0	1	The input and DAC register are transparent.
1			LDAC and $\overline{WR}$ are tied together and programmed as a pulse. The 16 data bits are loaded into the input register on the falling edge of the pulse and then loaded into the DAC register on the rising edge of the pulse.
1	1	0	No register operation.

TYPICAL CHARACTERISTICS:  $V_{DD} = +5V$

Channel A

LINEARITY ERROR  
vs DIGITAL INPUT CODE

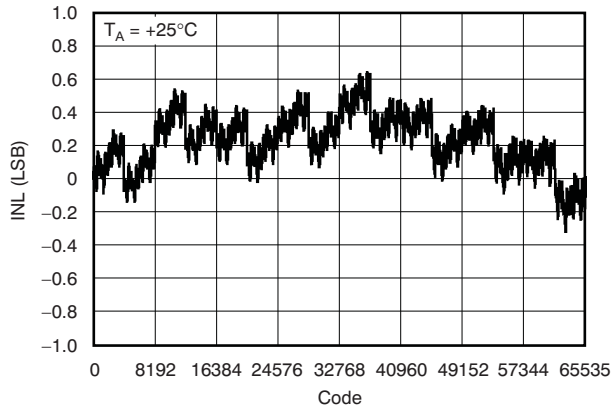

Figure 2.

DIFFERENTIAL LINEARITY ERROR  
vs DIGITAL INPUT CODE

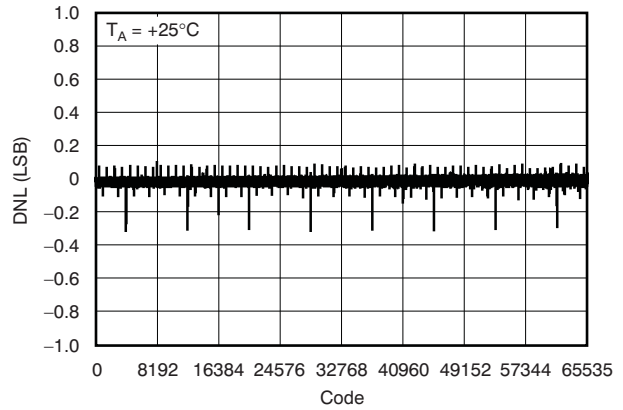

Figure 3.

LINEARITY ERROR  
vs DIGITAL INPUT CODE

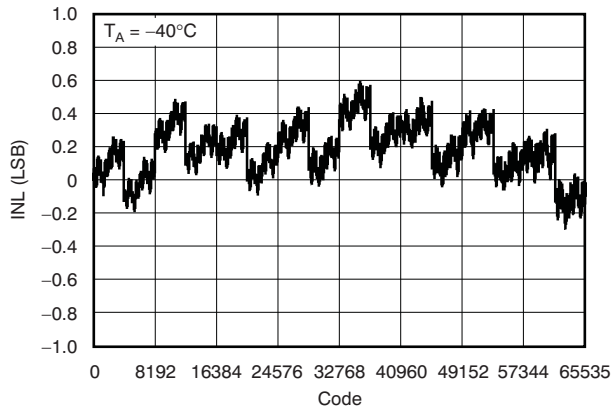

Figure 4.

DIFFERENTIAL LINEARITY ERROR  
vs DIGITAL INPUT CODE

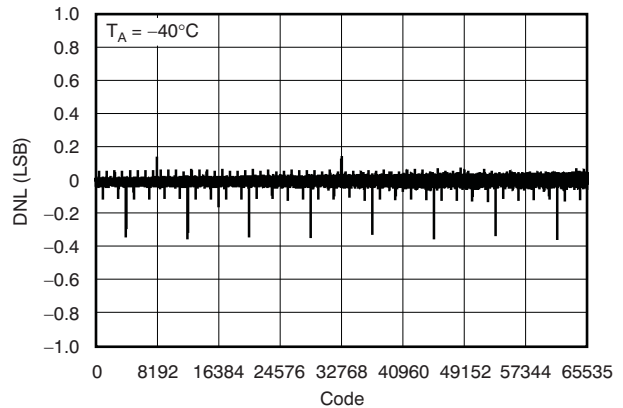

Figure 5.

LINEARITY ERROR  
vs DIGITAL INPUT CODE

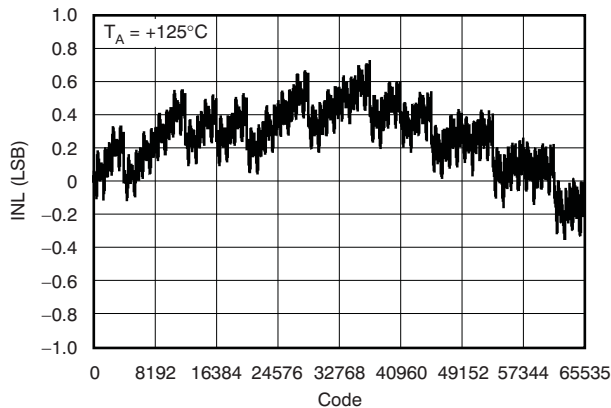

Figure 6.

DIFFERENTIAL LINEARITY ERROR  
vs DIGITAL INPUT CODE

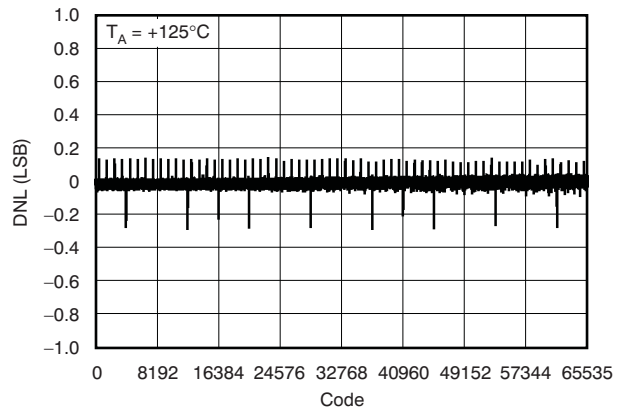

Figure 7.



TYPICAL CHARACTERISTICS:  $V_{DD} = +5V$  (continued)

Channel B

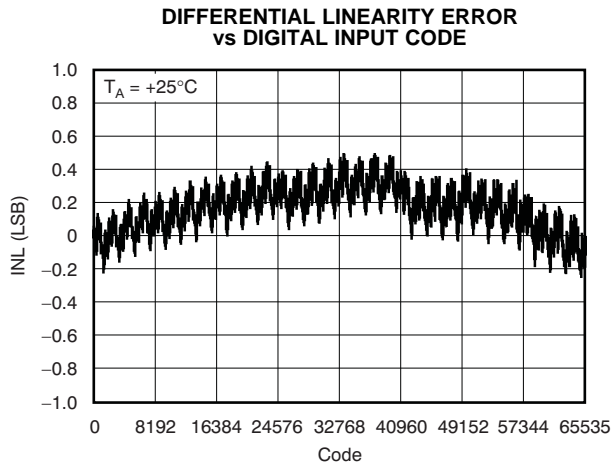

Figure 8.

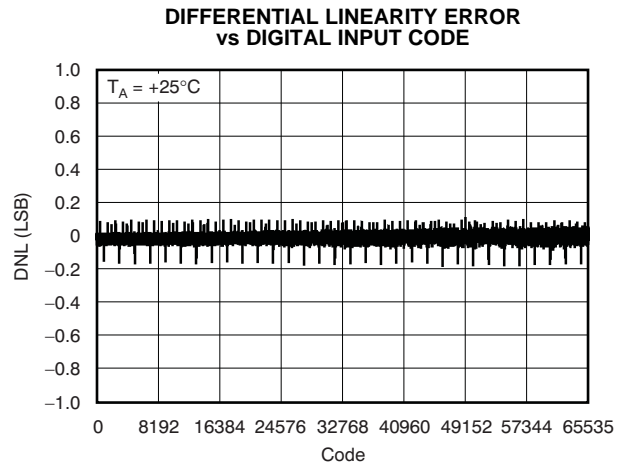

Figure 9.

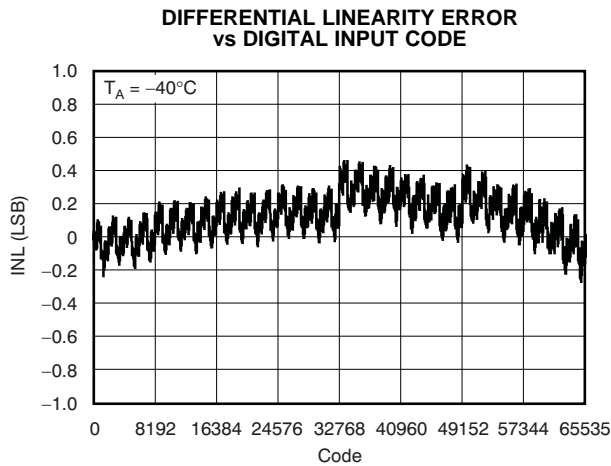

Figure 10.

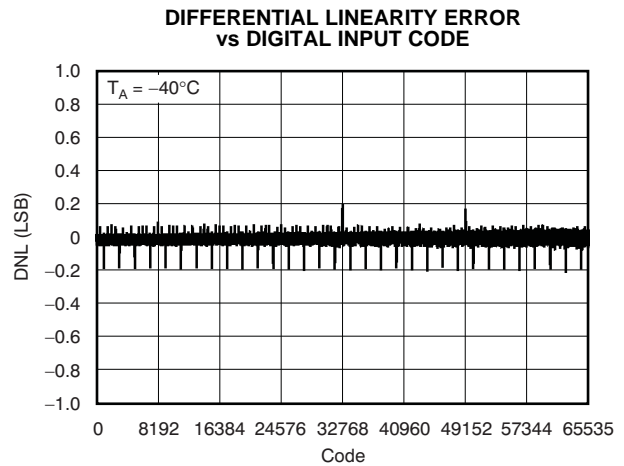

Figure 11.

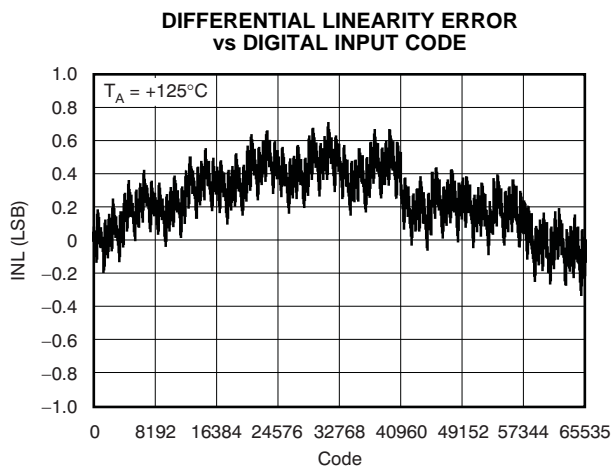

Figure 12.

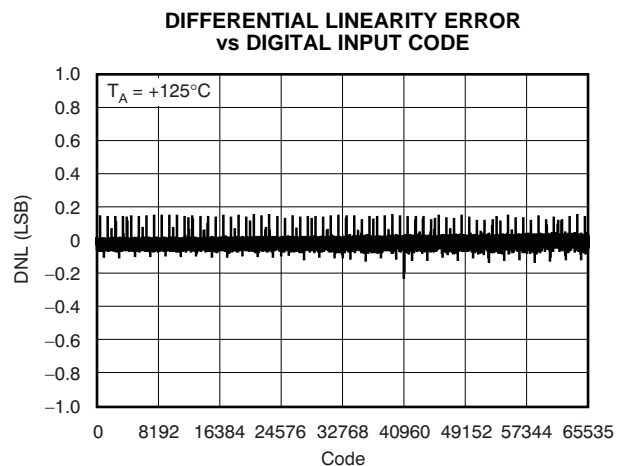

Figure 13.

TYPICAL CHARACTERISTICS:  $V_{DD} = +5V$  (continued)

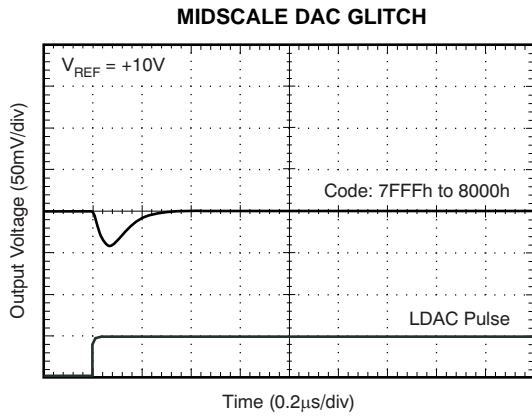

Figure 14.

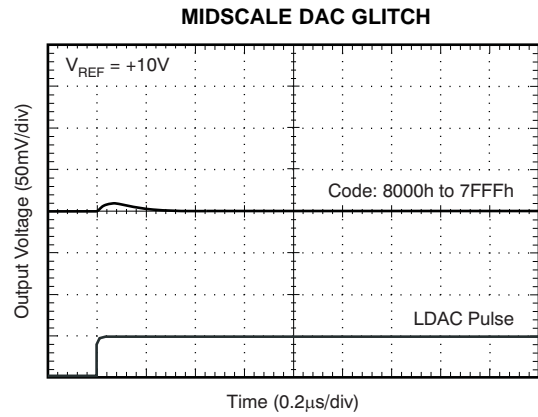

Figure 15.

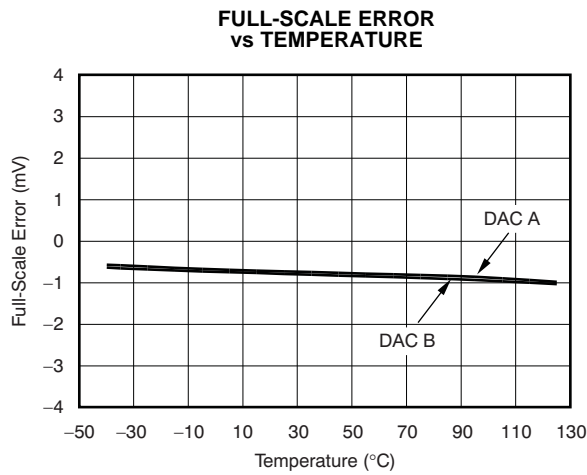

Figure 16.

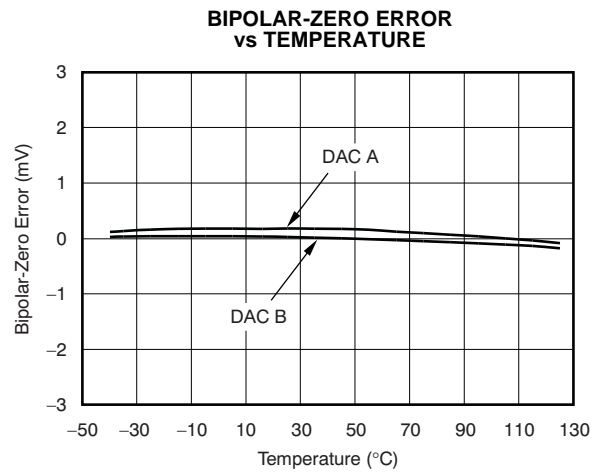
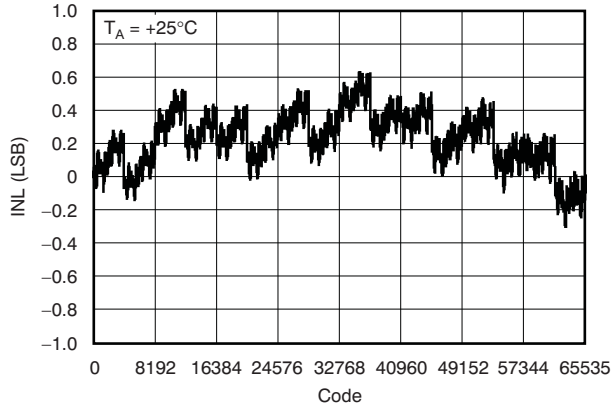

Figure 17.

**TYPICAL CHARACTERISTICS:  $V_{DD} = +2.7V$**

**Channel A**

**LINEARITY ERROR  
vs DIGITAL INPUT CODE**



**Figure 18.**

**LINEARITY ERROR  
vs DIGITAL INPUT CODE**

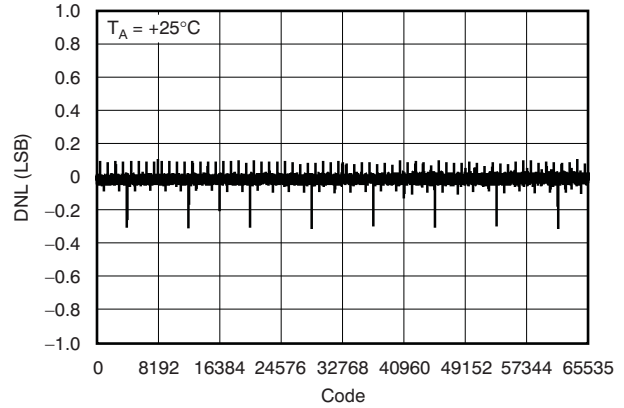

**Figure 19.**

**LINEARITY ERROR  
vs DIGITAL INPUT CODE**

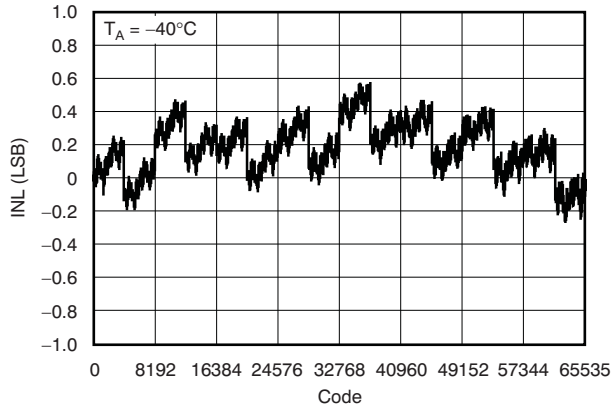

**Figure 20.**

**LINEARITY ERROR  
vs DIGITAL INPUT CODE**

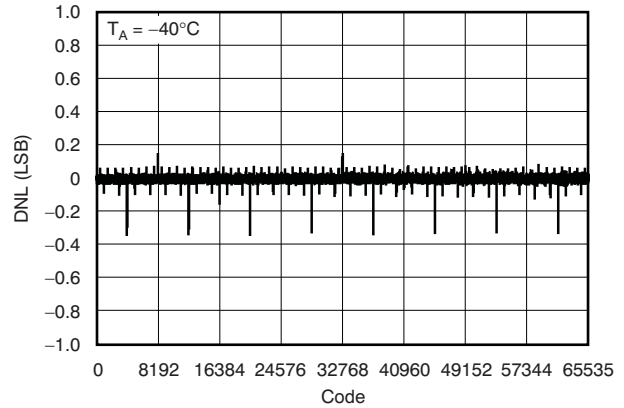

**Figure 21.**

**LINEARITY ERROR  
vs DIGITAL INPUT CODE**

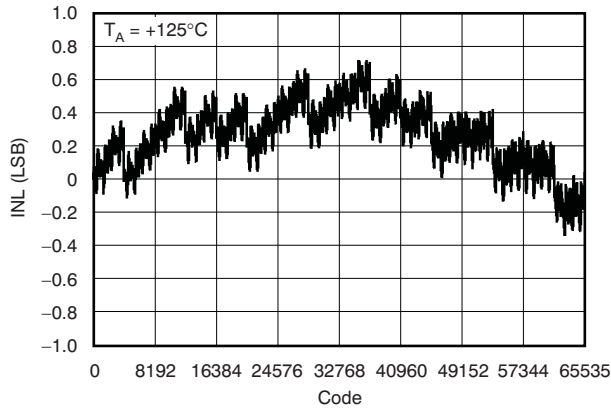

**Figure 22.**

**LINEARITY ERROR  
vs DIGITAL INPUT CODE**

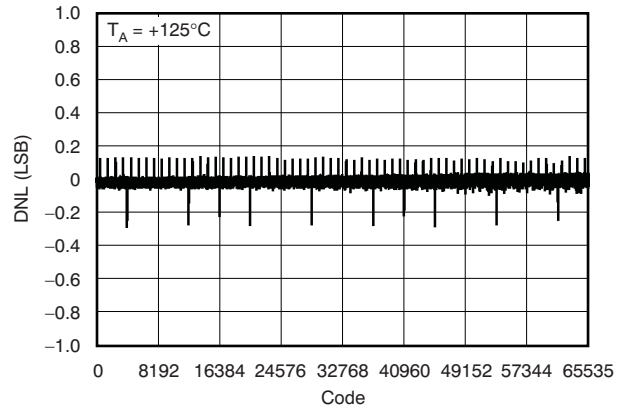

**Figure 23.**

TYPICAL CHARACTERISTICS:  $V_{DD} = +2.7V$  (continued)

Channel B

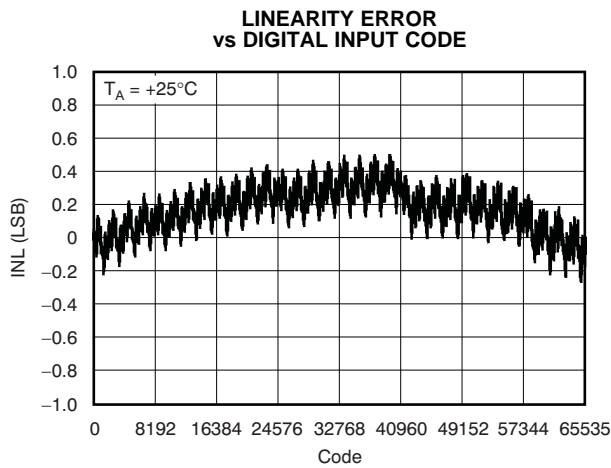

Figure 24.

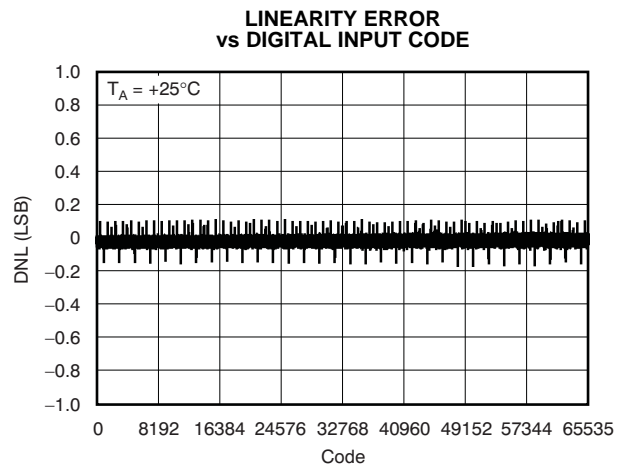

Figure 25.

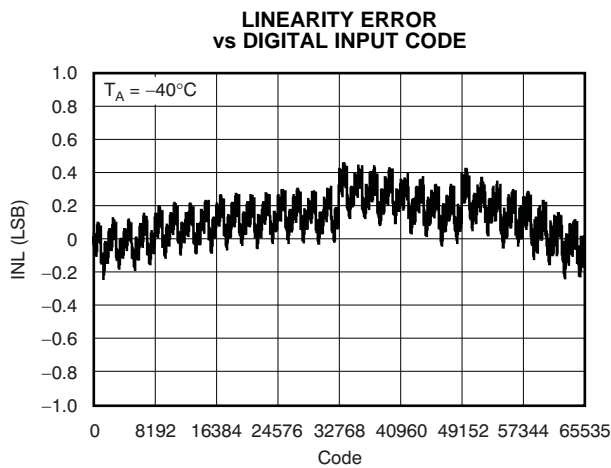

Figure 26.

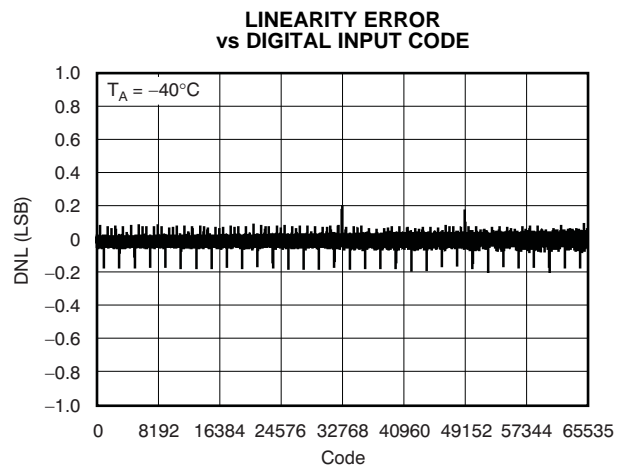

Figure 27.

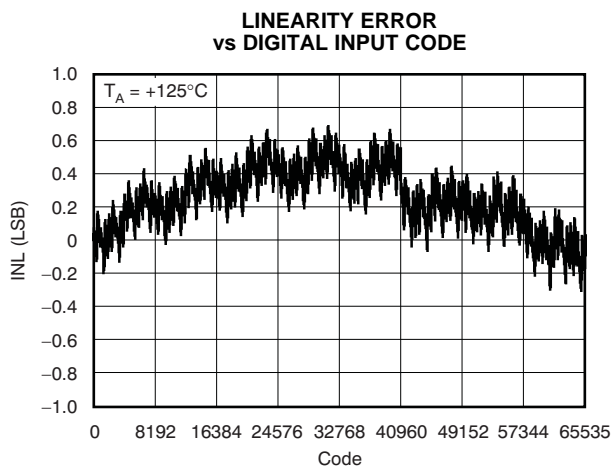

Figure 28.

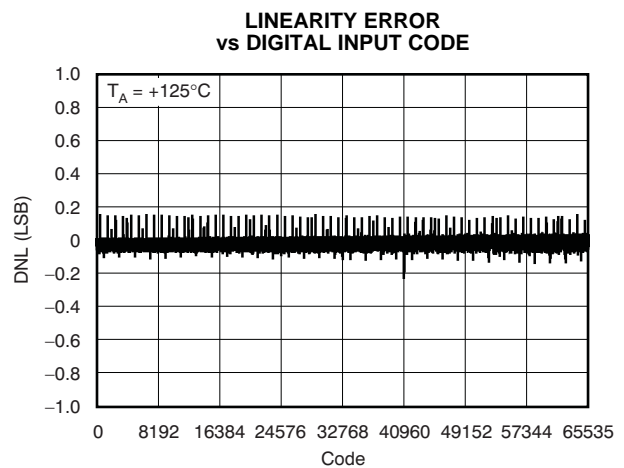
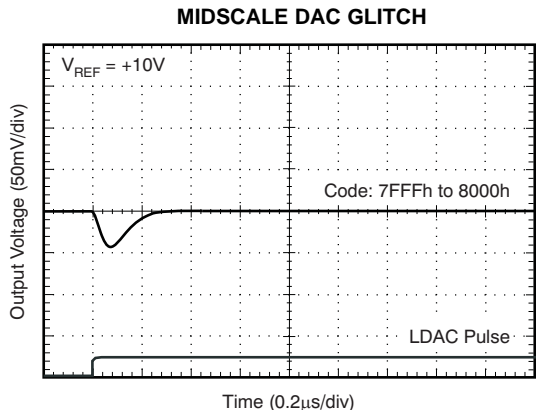
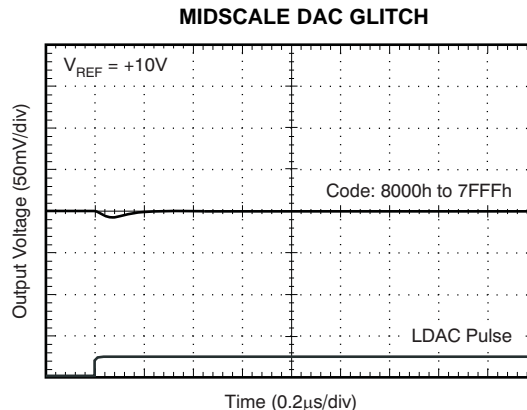

Figure 29.

**TYPICAL CHARACTERISTICS:  $V_{DD} = +2.7V$  (continued)**



**Figure 30.**



**Figure 31.**

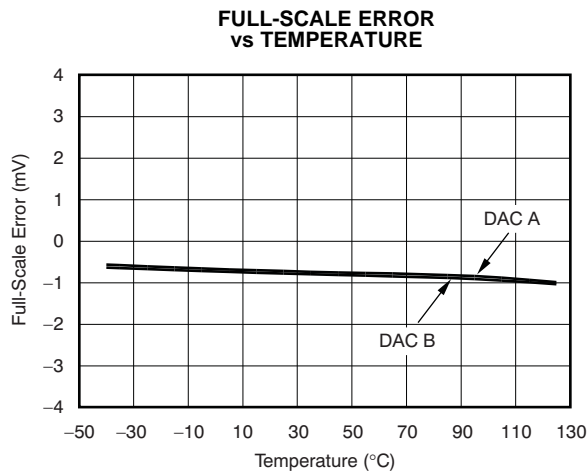

**Figure 32.**

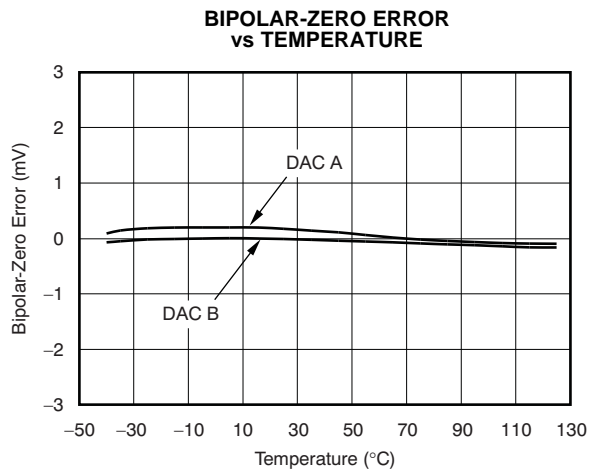

**Figure 33.**

TYPICAL CHARACTERISTICS:  $V_{DD} = +2.7V$  and  $+5V$

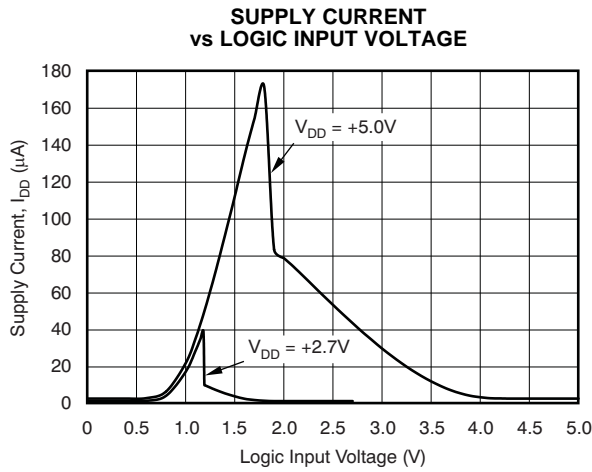

Figure 34.

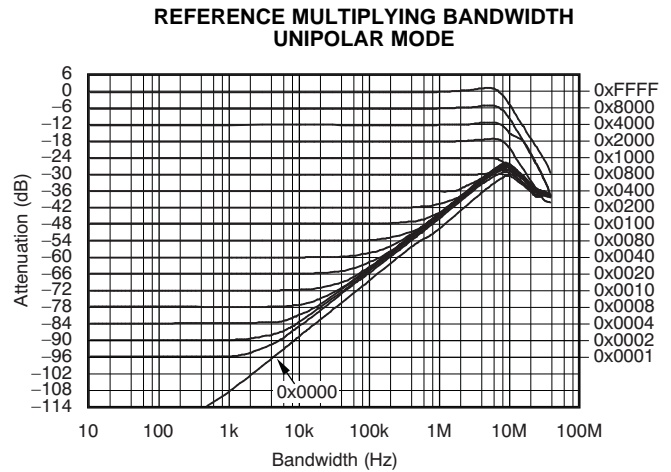

Figure 35.

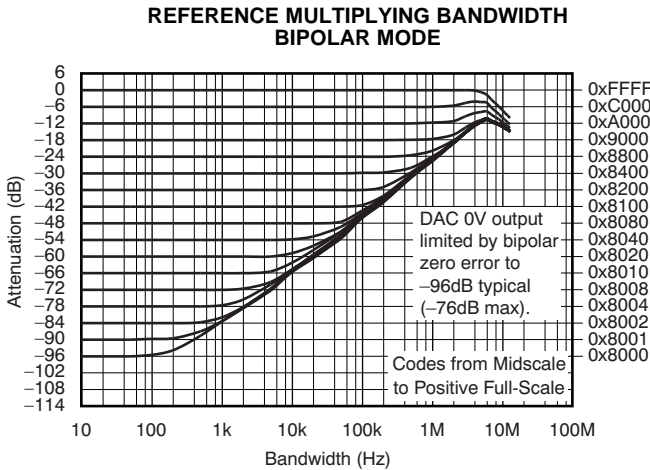

Figure 36.

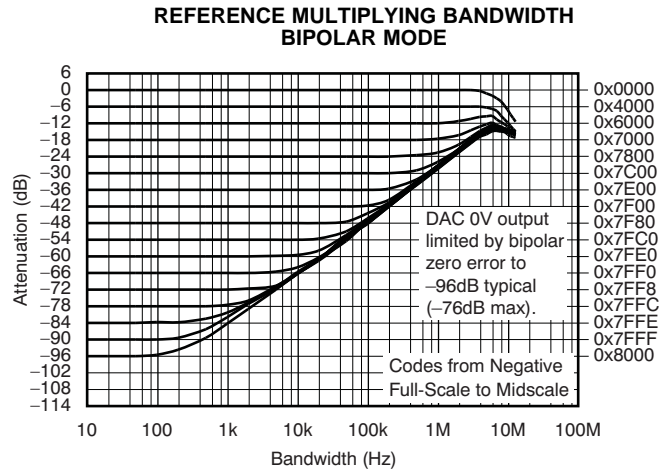

Figure 37.

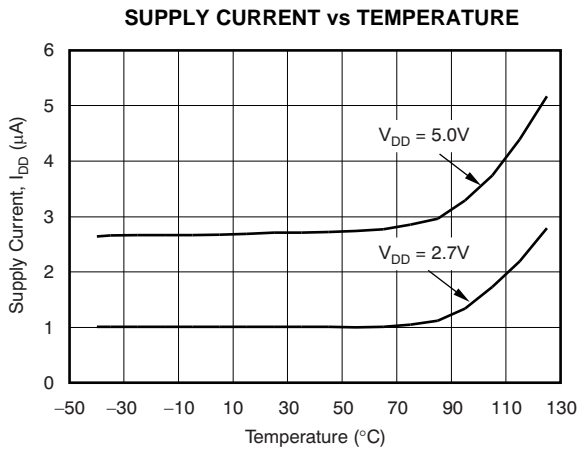

Figure 38.

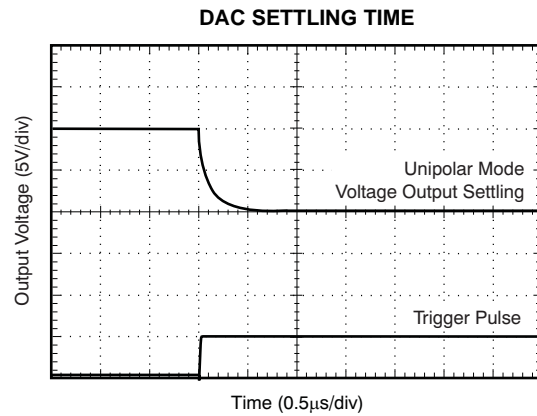
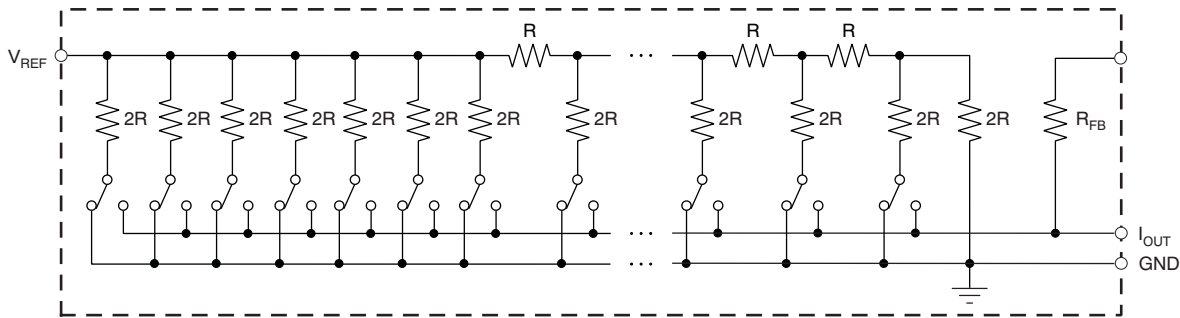

Figure 39.

## THEORY OF OPERATION

The DAC8822 is a multiplying, dual-channel, current output, 16-bit DAC. The architecture, illustrated in [Figure 40](#), is an R-2R ladder configuration with the three MSBs segmented. Each 2R leg of the ladder is either switched to GND or to the  $I_{OUT}$  terminal. The  $I_{OUT}$  terminal of the DAC is held at a virtual GND potential by the use of an external I/V converter op amp. The R-2R ladder is connected to an external reference input ( $V_{REF}$ ) that determines the DAC full-scale output current. The R-2R ladder presents a code-independent load impedance to the external reference of  $5k\Omega \pm 25\%$ . The external reference voltage can vary in a range of  $-18V$  to  $+18V$ , thus providing bipolar  $I_{OUT}$  current operation. By using an external I/V converter op amp and the  $R_{FB}$  resistor in the DAC8822, an output voltage range of  $-V_{REF}$  to  $+V_{REF}$  can be generated.

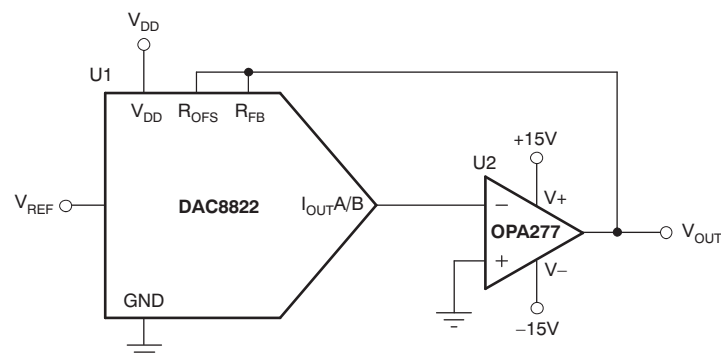

**Figure 40. Equivalent R-2R DAC Circuit**

The DAC output voltage is determined by  $V_{REF}$  and the digital data (D) according to [Equation 1](#):

$$V_{OUT\ A/B} = -V_{REF} \times \frac{D}{65536} \quad (1)$$

Each DAC code determines the 2R-leg switch position to either GND or  $I_{OUT}$ . The external I/V converter op amp noise gain will also change because the DAC output impedance (as seen looking into the  $I_{OUT}$  terminal) changes versus code. Because of this change in noise gain, the external I/V converter op amp must have a sufficiently low offset voltage such that the amplifier offset is not modulated by the DAC  $I_{OUT}$  terminal impedance change. External op amps with large offset voltages can produce INL errors in the transfer function of the DAC8822 because of offset modulation versus DAC code. For best linearity performance of the DAC8822, an op amp (such as the [OPA277](#)) is recommended, as shown in [Figure 41](#). This circuit allows  $V_{REF}$  to swing from  $-10V$  to  $+10V$ .



**Figure 41. Voltage Output Configuration**

## APPLICATION INFORMATION

### DIGITAL INTERFACE

The parallel bus interface of the DAC8822 is comprised of a 16-bit data bus D0—D15, address lines A0 and A1, and a  $\overline{WR}$  control signal. Timing and control functionality are shown in [Figure 1](#), and described in [Table 2](#) and [Table 3](#). The address lines must be set up and stable before the  $\overline{WR}$  signal goes low, to prevent loading improper data to an undesired input register.

Both channels of the DAC8822 can be simultaneously updated by control of the LDAC signal, as shown in [Figure 1](#). Reset control ( $\overline{RS}$ ) and reset select control (RSTSEL) signals are provided to allow user reset ability to either zero scale or midscale codes of both the input and DAC registers.

### STABILITY CIRCUIT

For a current-to-voltage (I/V) design, as shown in [Figure 42](#), the DAC8822 current output ( $I_{OUT}$ ) and the connection with the inverting node of the op amp should be as short as possible and laid out according to correct printed circuit board (PCB) layout design. For each code change, there is an output step function. If the gain bandwidth product (GBP) of the op amp is limited and parasitic capacitance is excessive at the inverting node, then gain peaking is possible. Therefore, a compensation capacitor  $C_1$  (4pF to 20pF, typ) can be added to the design for circuit stability, as shown in [Figure 42](#).

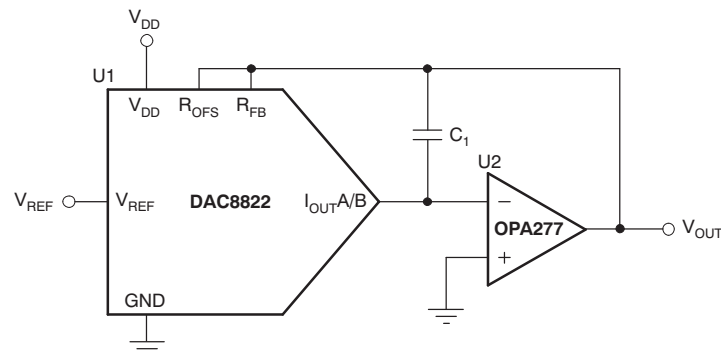

**Figure 42. Gain Peaking Prevention Circuit with Compensation Capacitor**



APPLICATION INFORMATION (continued)

BIPOLAR OUTPUT CIRCUIT

The DAC8822, as a 4-quadrant multiplying DAC, can be used to generate a bipolar output. The polarity of the full-scale output ( $I_{OUT}$ ) is the inverse of the input reference voltage at  $V_{REF}$ .

Using a dual op amp, such as the OPA2277, full 4-quadrant operation can be achieved with minimal components. Figure 43 demonstrates a  $\pm 10V_{OUT}$  circuit with a fixed +10V reference. The output voltage is shown in Equation 2:

$$V_{OUT} = \left( \frac{D}{32768} - 1 \right) \times V_{REF} \tag{2}$$

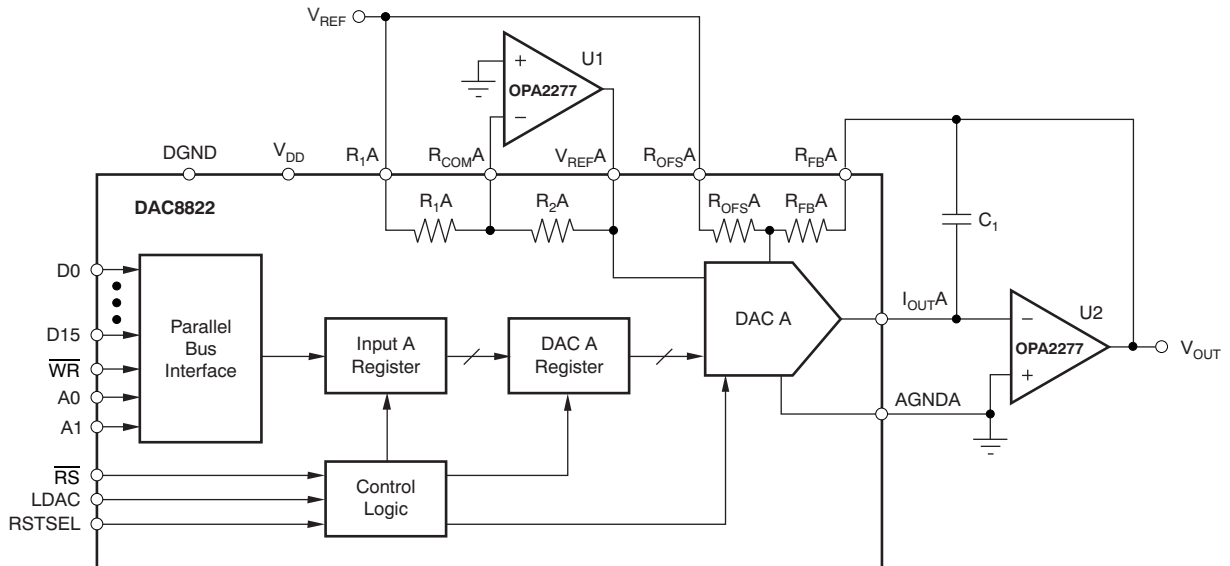

Figure 43. Bipolar Output Circuit for Channel A

**APPLICATION INFORMATION (continued)**

**PROGRAMMABLE CURRENT SOURCE CIRCUIT**

The DAC8822 can be integrated into the circuit in [Figure 44](#) to implement an improved Howland current pump for precise V/I conversions. Bidirectional current flow and high-voltage compliance are two features of the circuit. With a matched resistor network, the load current of the circuit is shown by [Equation 3](#):

$$I_{L\ A/B} = \frac{(R_2 + R_3) / R_1}{R_3} \times V_{REF} \times \frac{D}{65536} \tag{3}$$

The value of  $R_3$  in the previous equation can be reduced to increase the output current drive of U3. U3 can drive  $\pm 20\text{mA}$  in both directions with voltage compliance limited up to 15V by the U3 voltage supply. Elimination of the circuit compensation capacitor ( $C_1$ ) in the circuit is not suggested as a result of the change in the output impedance ( $Z_O$ ), according to [Equation 4](#):

$$Z_O = \frac{R_1' R_3 (R_1 + R_2)}{R_1 (R_2' + R_3') - R_1' (R_2 + R_3)} \tag{4}$$

As shown in [Equation 4](#),  $Z_O$  with matched resistors is infinite and the circuit is optimum for use as a current source. However, if unmatched resistors are used,  $Z_O$  is positive or negative with negative output impedance being a potential cause of oscillation. Therefore, by incorporating  $C_1$  into the circuit, possible oscillation problems are eliminated. The value of  $C_1$  can be determined for critical applications; for most applications, however, a value of several pF is suggested.

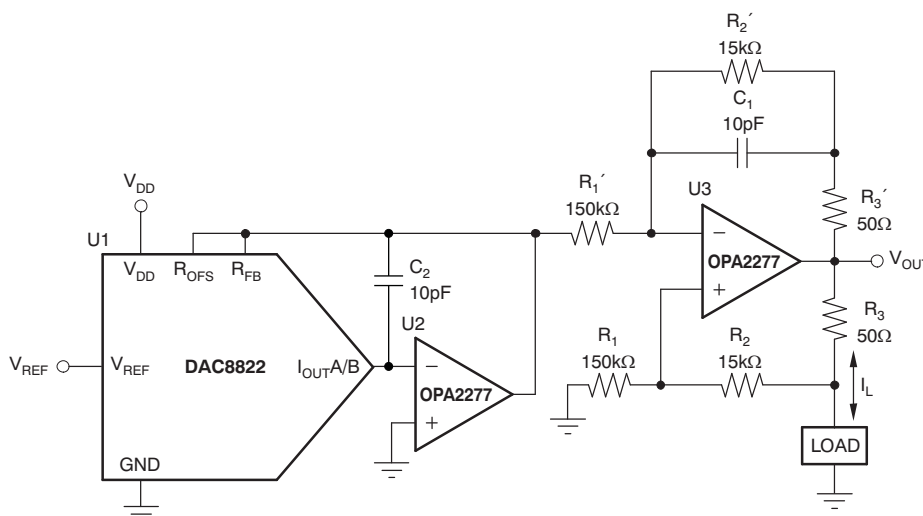

**Figure 44. Programmable Bidirectional Current Source Circuit**

**CROSS-REFERENCE**

The DAC8822 has an industry-standard pinout. [Table 4](#) provides the cross-reference information.

**Table 4. Cross-Reference**

PRODUCT	BIT	INL (LSB)	DNL (LSB)	SPECIFIED TEMPERATURE RANGE	PACKAGE DESCRIPTION	PACKAGE OPTION	CROSS-REFERENCE PART
DAC8822QB	16	2	1	-40°C to +125°C	TSSOP-38	DBT	AD5547B
DAC8822QC	16	1	1	-40°C to +125°C	TSSOP-38	DBT	N/A

**PACKAGING INFORMATION**

Orderable Device	Status (1)	Package Type	Package Drawing	Pins	Package Qty	Eco Plan (2)	Lead/Ball Finish (6)	MSL Peak Temp (3)	Op Temp (°C)	Device Marking (4/5)	Samples
DAC8822QBDBT	ACTIVE	TSSOP	DBT	38	50	Green (RoHS & no Sb/Br)	NIPDAU	Level-2-260C-1 YEAR	-40 to 125	DAC8822	<a href="#">Samples</a>
DAC8822QBDBTR	ACTIVE	TSSOP	DBT	38	2000	Green (RoHS & no Sb/Br)	NIPDAU	Level-2-260C-1 YEAR	-40 to 125	DAC8822	<a href="#">Samples</a>
DAC8822QCDBT	ACTIVE	TSSOP	DBT	38	50	Green (RoHS & no Sb/Br)	NIPDAU	Level-2-260C-1 YEAR	-40 to 125	DAC8822	<a href="#">Samples</a>
DAC8822QCDBTG4	ACTIVE	TSSOP	DBT	38	50	Green (RoHS & no Sb/Br)	NIPDAU	Level-2-260C-1 YEAR	-40 to 125	DAC8822	<a href="#">Samples</a>
DAC8822QCDBTR	ACTIVE	TSSOP	DBT	38	2000	Green (RoHS & no Sb/Br)	NIPDAU	Level-2-260C-1 YEAR	-40 to 125	DAC8822	<a href="#">Samples</a>

(1) The marketing status values are defined as follows:

**ACTIVE:** Product device recommended for new designs.

**LIFEBUY:** TI has announced that the device will be discontinued, and a lifetime-buy period is in effect.

**NRND:** Not recommended for new designs. Device is in production to support existing customers, but TI does not recommend using this part in a new design.

**PREVIEW:** Device has been announced but is not in production. Samples may or may not be available.

**OBSOLETE:** TI has discontinued the production of the device.

(2) **RoHS:** TI defines "RoHS" to mean semiconductor products that are compliant with the current EU RoHS requirements for all 10 RoHS substances, including the requirement that RoHS substance do not exceed 0.1% by weight in homogeneous materials. Where designed to be soldered at high temperatures, "RoHS" products are suitable for use in specified lead-free processes. TI may reference these types of products as "Pb-Free".

**RoHS Exempt:** TI defines "RoHS Exempt" to mean products that contain lead but are compliant with EU RoHS pursuant to a specific EU RoHS exemption.

**Green:** TI defines "Green" to mean the content of Chlorine (Cl) and Bromine (Br) based flame retardants meet JS709B low halogen requirements of <=1000ppm threshold. Antimony trioxide based flame retardants must also meet the <=1000ppm threshold requirement.

(3) MSL, Peak Temp. - The Moisture Sensitivity Level rating according to the JEDEC industry standard classifications, and peak solder temperature.

(4) There may be additional marking, which relates to the logo, the lot trace code information, or the environmental category on the device.

(5) Multiple Device Markings will be inside parentheses. Only one Device Marking contained in parentheses and separated by a "-" will appear on a device. If a line is indented then it is a continuation of the previous line and the two combined represent the entire Device Marking for that device.

(6) Lead/Ball Finish - Orderable Devices may have multiple material finish options. Finish options are separated by a vertical ruled line. Lead/Ball Finish values may wrap to two lines if the finish value exceeds the maximum column width.

**Important Information and Disclaimer:** The information provided on this page represents TI's knowledge and belief as of the date that it is provided. TI bases its knowledge and belief on information provided by third parties, and makes no representation or warranty as to the accuracy of such information. Efforts are underway to better integrate information from third parties. TI has taken and continues to take reasonable steps to provide representative and accurate information but may not have conducted destructive testing or chemical analysis on incoming materials and chemicals. TI and TI suppliers consider certain information to be proprietary, and thus CAS numbers and other limited information may not be available for release.

In no event shall TI's liability arising out of such information exceed the total purchase price of the TI part(s) at issue in this document sold by TI to Customer on an annual basis.

**TAPE AND REEL INFORMATION**

**QUADRANT ASSIGNMENTS FOR PIN 1 ORIENTATION IN TAPE**

\*All dimensions are nominal

Device	Package Type	Package Drawing	Pins	SPQ	Reel Diameter (mm)	Reel Width W1 (mm)	A0 (mm)	B0 (mm)	K0 (mm)	P1 (mm)	W (mm)	Pin1 Quadrant
DAC8822QBDBTR	TSSOP	DBT	38	2000	330.0	16.4	6.9	10.2	1.8	12.0	16.0	Q1
DAC8822QCDBTR	TSSOP	DBT	38	2000	330.0	16.4	6.9	10.2	1.8	12.0	16.0	Q1

TAPE AND REEL BOX DIMENSIONS



\*All dimensions are nominal

Device	Package Type	Package Drawing	Pins	SPQ	Length (mm)	Width (mm)	Height (mm)
DAC8822QBDBTR	TSSOP	DBT	38	2000	350.0	350.0	43.0
DAC8822QCDBTR	TSSOP	DBT	38	2000	350.0	350.0	43.0

# MECHANICAL DATA

DBT (R-PDSO-G38)

PLASTIC SMALL OUTLINE

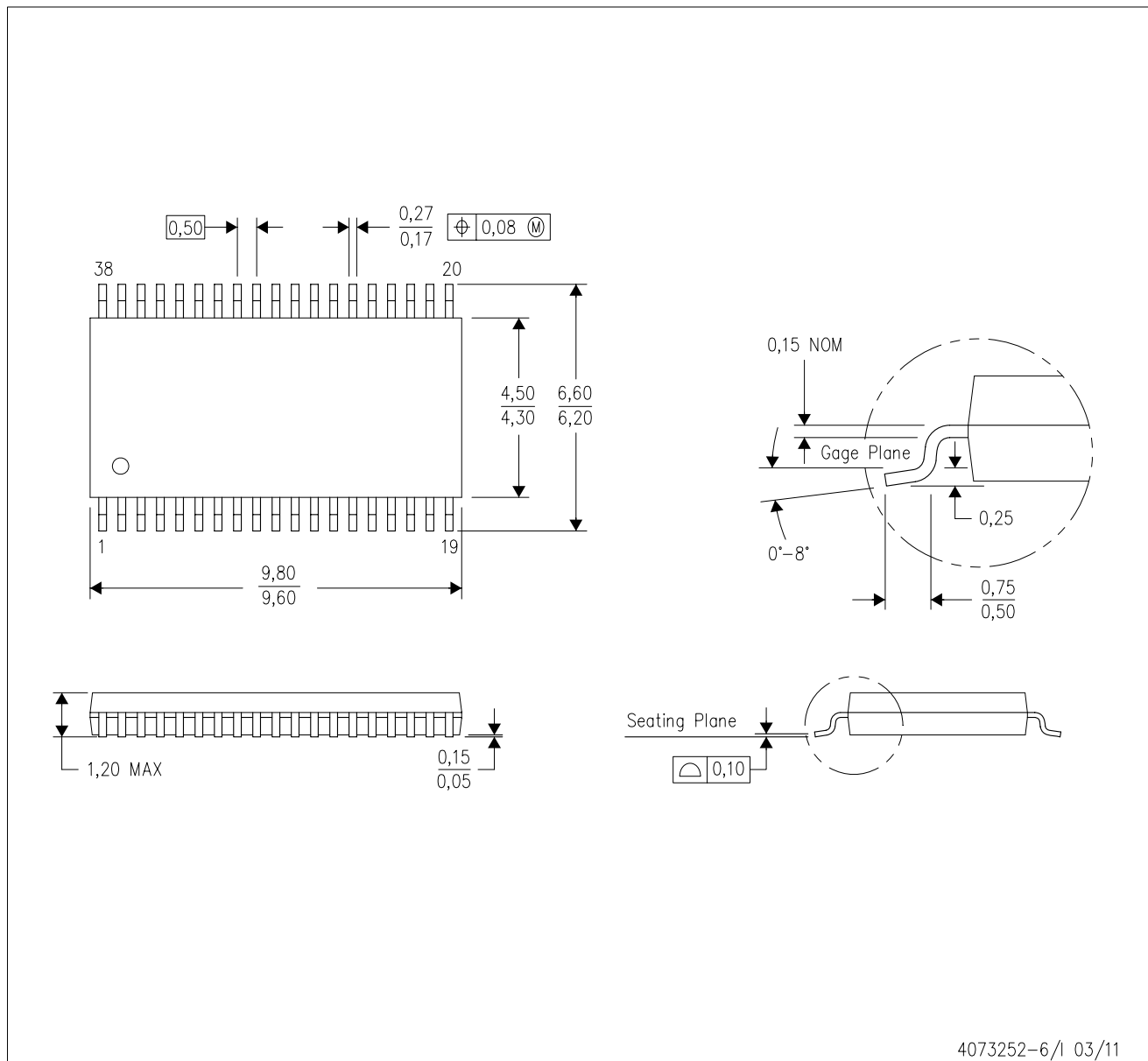

- NOTES:
- All linear dimensions are in millimeters. Dimensioning and tolerancing per ASME Y14.5M-1994.
  - This drawing is subject to change without notice.
  - Body dimensions do not include mold flash or protrusion.
  - Falls within JEDEC MO-153.

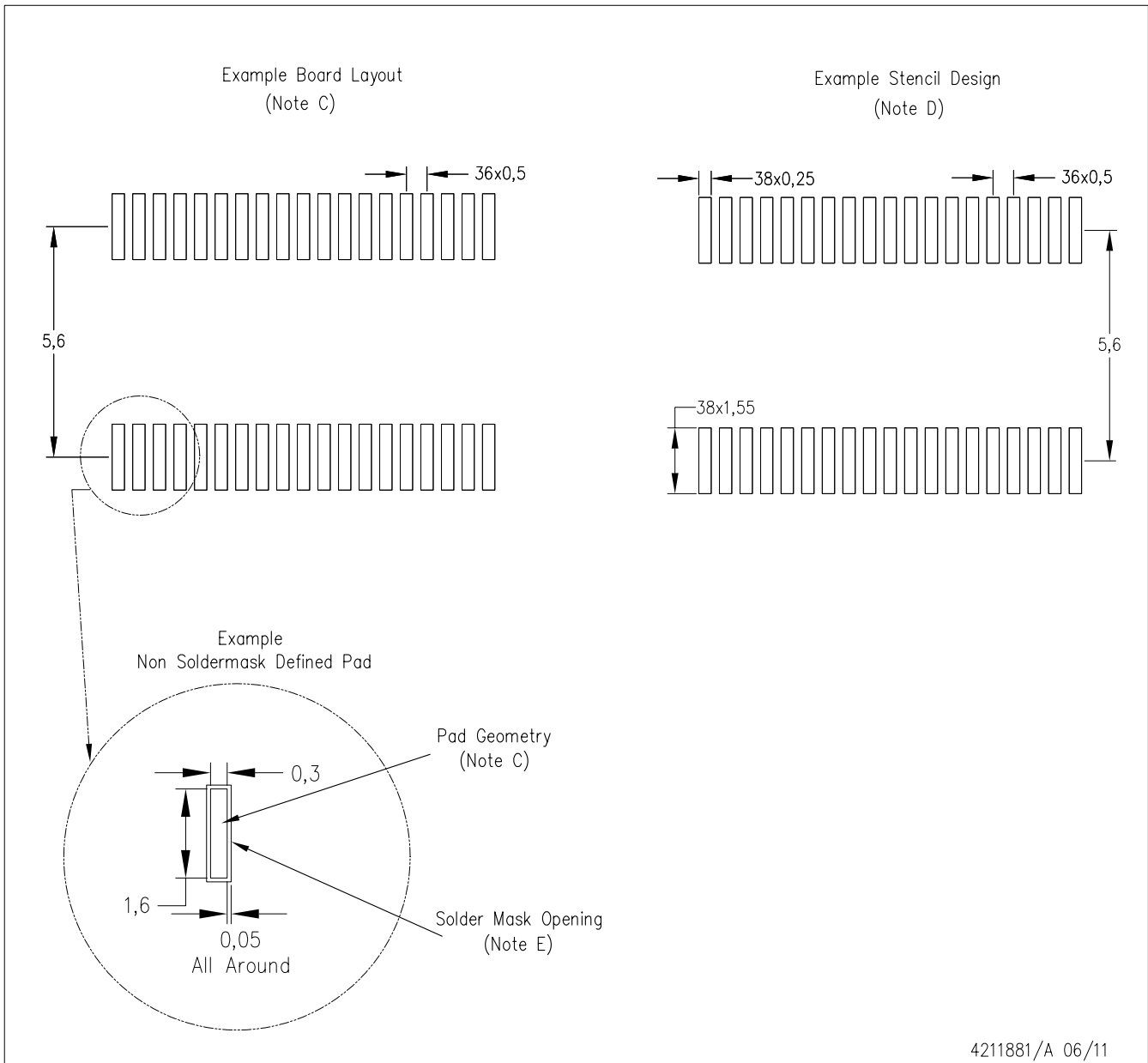

- NOTES:
- A. All linear dimensions are in millimeters.
  - B. This drawing is subject to change without notice.
  - C. Publication IPC-7351 is recommended for alternate designs.
  - D. Laser cutting apertures with trapezoidal walls and also rounding corners will offer better paste release. Customers should contact their board assembly site for stencil design recommendations. Refer to IPC-7525.
  - E. Customers should contact their board fabrication site for solder mask tolerances between and around signal pads.



## IMPORTANT NOTICE AND DISCLAIMER

TI PROVIDES TECHNICAL AND RELIABILITY DATA (INCLUDING DATASHEETS), DESIGN RESOURCES (INCLUDING REFERENCE DESIGNS), APPLICATION OR OTHER DESIGN ADVICE, WEB TOOLS, SAFETY INFORMATION, AND OTHER RESOURCES "AS IS" AND WITH ALL FAULTS, AND DISCLAIMS ALL WARRANTIES, EXPRESS AND IMPLIED, INCLUDING WITHOUT LIMITATION ANY IMPLIED WARRANTIES OF MERCHANTABILITY, FITNESS FOR A PARTICULAR PURPOSE OR NON-INFRINGEMENT OF THIRD PARTY INTELLECTUAL PROPERTY RIGHTS.

These resources are intended for skilled developers designing with TI products. You are solely responsible for (1) selecting the appropriate TI products for your application, (2) designing, validating and testing your application, and (3) ensuring your application meets applicable standards, and any other safety, security, or other requirements. These resources are subject to change without notice. TI grants you permission to use these resources only for development of an application that uses the TI products described in the resource. Other reproduction and display of these resources is prohibited. No license is granted to any other TI intellectual property right or to any third party intellectual property right. TI disclaims responsibility for, and you will fully indemnify TI and its representatives against, any claims, damages, costs, losses, and liabilities arising out of your use of these resources.

TI's products are provided subject to TI's Terms of Sale ([www.ti.com/legal/termsofsale.html](http://www.ti.com/legal/termsofsale.html)) or other applicable terms available either on [ti.com](http://ti.com) or provided in conjunction with such TI products. TI's provision of these resources does not expand or otherwise alter TI's applicable warranties or warranty disclaimers for TI products.

Mailing Address: Texas Instruments, Post Office Box 655303, Dallas, Texas 75265  
Copyright © 2020, Texas Instruments Incorporated