

5.0 mm Power Key Connectors (5.0 PKC) (Wire-to-Board)

Product Facts

- Compact design with 19.4 mm mated height
- Power circuit connector with 5.0 mm contact centerline
- Wire-to-board connectors consisting of plug housings for wires and PCB header assemblies
- With a clear clicking sound, contact insertions can be made easier. The double lock plate provides for complete loading of contacts
- Locking levers are surrounded by walls, which protect levers and prevent tangling with wires
- Connector is designed to release bubbles created by the process of potting (PC board coating)
- Housing lances also help prevent tangling of wired contacts
- Recognized under the Component Program of Underwriters Laboratories Inc., File No. E28476 
- Certified by Canadian Standards Association, File No. LR7189 



5.0 mm Power Key Connectors are for power circuits of home appliances, especially targeting gas appliances. The connector features four kinds of keying per housing.

Only color-coding of housings limited the efficiency of blind mating where you could not see connectors. However, the new keying mechanism not only improves assembly efficiency but also helps prevent mismatching.

Part numbers involved can be reduced so that purchasing and stock level control can be made simpler.

Performance Characteristics

Voltage Rating—300 VAC¹

Current Rating—10A max.²

Operating Temperature—
-30°C ~ +105°C

Applicable Wire—24-16 AWG

Applicable PC Board Thickness—
1.6 mm

¹ Excludes header tyne round space. Usable for 150 VAC applications when the round dimensions are 3 mm or less.

² Specified values vary according to the number of contacts and the wire used. The 10 A maximum value applies to 16 AWG wire used with 2 contacts.

Technical Documents

Product Specification

108-5699

Application Specification

114-5292

5.0 mm Power Key Connectors (5.0 PKC) (Wire-to-Board) (Continued)

Quick Reference Chart for Mating Part Numbers

| No. of Pos. | Plug Housing | | Applicable Double Lock Plate Part Number | Mating Header Assy. Part Number | |
|--------------|----------------------|-------------|--|---------------------------------|-------------|
| | Type of Keying/Color | Part Number | | | |
| 2 | Type A/Natural | 1376388-1 | 1376394-1 | 1376382-1 | |
| | Type B/Red | 1-1376388-2 | 1376394-1 | 1-1376382-2 | |
| | Type C/Blue | 2-1376388-3 | 1376294-1 | 2-1376382-3 | |
| | Type D/Yellow | 3-1376388-4 | 1376394-1 | 3-1376382-4 | |
| 3 | Type A/Natural | 1376389-1 | 1376395-1 | 1376383-1 | 1376421-1 |
| | Type B/Red | 1-1376389-2 | 1376395-1 | 1-1376383-2 | 1-1376421-2 |
| | Type C/Blue | 2-1376389-3 | 1376395-1 | 2-1376383-3 | 2-1376421-3 |
| | Type D/Yellow | 3-1376389-4 | 1376395-1 | 3-1376383-4 | 3-1376421-4 |
| 4 | Type A/Natural | 1376390-1 | 1376396-1 | 1376384-1 | |
| | Type B/Red | 1-1376390-2 | 1376396-1 | 1-1376384-2 | |
| | Type C/Blue | 2-1376390-3 | 1376396-1 | 2-1376384-3 | |
| | Type D/Yellow | 3-1376390-4 | 1376396-1 | 3-1376384-4 | |
| 6 | Type A/Natural | 1376391-1 | 1376397-1 | 1376385-1 | |
| | Type B/Red | 1-1376391-2 | 1376397-1 | 1-1376385-2 | |
| | Type C/Blue | 2-1376391-3 | 1376397-1 | 2-1376385-3 | |
| | Type D/Yellow | 3-1376391-4 | 1376397-1 | 3-1376385-4 | |
| 2 Row | | | | | |
| 4 | Type A/Natural | 1376392-1 | 1376394-1 | 1376386-1 | |
| | Type B/Red | 1-1376392-2 | 1376394-1 | 1-1376386-2 | |
| | Type C/Blue | 2-1376392-3 | 1376394-1 | 2-1376386-3 | |
| | Type D/Yellow | 3-1376392-4 | 1376394-1 | 3-1376386-4 | |
| 6 | Type A/Natural | 1376393-1 | 1376395-1 | 1376387-1 | |
| | Type B/Red | 1-1376393-2 | 1376395-1 | 1-1376387-2 | |
| | Type C/Blue | 2-1376393-3 | 1376395-1 | 2-1376387-3 | |
| | Type D/Yellow | 3-1376393-4 | 1376395-1 | 3-1376387-4 | |

*Included in Header Assy. line are Tube Stick version. Refer to the appropriate description in the catalog.

Note: All part numbers are RoHS Compliant.

Mating Configurations

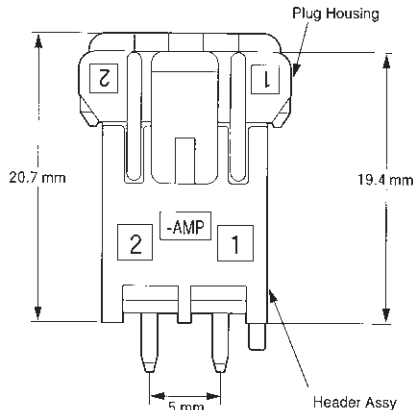

Note: Dimensions shown are metric.

5.0 mm Power Key Connectors .197 [5.00] Centerline Standard Density

5.0 mm Power Key Connectors (5.0 PKC) (Wire-to-Board) (Continued)

Receptacle Contacts

Material and Finish
Pre-tinned Copper Alloy



| Wire Range | | Wire Ins. Dia. | Receptacle Contact Part No. | Applicator Part No. |
|------------|-----------------|----------------|-----------------------------|---------------------|
| AWG | mm ² | | | |
| 24~20 | 0.22~0.53 | 1.89~2.7 | 1376348-1 (Strip Form) | * |
| 20~16 | 0.5~1.25 | 2.0~3.1 | 1376347-1 (Strip Form) | * |

* Contact the Tooling Assistance Center (TAC) at 1-800-722-1111 for Applicator Part Number.

Note: Dimensions shown are metric.

Note: All part numbers are RoHS Compliant.

Double Lock Plates

Material and Finish
UL94V-0, 6/6 Nylon, glass filled, Black



| No. of Pos. | Dimensions (Double Lock Plate) | | Double Lock Plate Part No. | Applicable Plug Part No. | |
|-------------|--------------------------------|----|----------------------------|--------------------------|-------------|
| | A | B | | | |
| 2 | 13.5 | 5 | 1376394-1 | □-1376388-□ | □-1376392-□ |
| 3 | 18.5 | 10 | 1376395-1 | □-1376389-□ | □-1376393-□ |
| 4 | 23.5 | 15 | 1376396-1 | □-1376390-□ | |
| 6 | 33.5 | 25 | 1376397-1 | □-1376391-□ | |

* Contact the Tooling Assistance Center (TAC) for Applicator Part Number.

Note: Dimensions shown are metric.

Note: All part numbers are RoHS Compliant.

5.0 mm Power Key Connectors (5.0 PKC) (Wire-to-Board) (Continued)

**Plug Housings
(For Receptacle Contacts)**

Material and Finish
Housing—6/6 Nylon, glass filled

Related Product Data
Receptacle Contacts—page 137
Double Lock Plates—page 137
Mating Headers—page 140



Type of Keying/Color



| No. of Pos. | Dimensions | | Plug Housing Part No. | | | | Applicable Double Lock Plate Part Number | Mating Header Assy. Part Number |
|-------------|------------|----|-----------------------|-------------|-------------|---------------|--|---------------------------------|
| | A | B | Type of Keying/Color | | | | | |
| | | | Type A Natural | Type B Red | Type C Blue | Type D Yellow | | |
| 2 | 15 | — | 1376388-1 | 1-1376388-2 | 2-1376388-3 | 3-1376388-4 | 1376394-1 | □-1376382-□ |
| 3 | 20 | 10 | 1376389-1 | 1-1376389-2 | 2-1376389-3 | 3-1376389-4 | 1376395-1 | □-1376383-□ □-1376421-□ |
| 4 | 25 | 15 | 1376390-1 | 1-1376390-2 | 2-1376390-3 | 3-1376390-4 | 1376396-1 | □-1376384-□ |
| 6 | 35 | 25 | 1376391-1 | 1-1376391-2 | 2-1376391-3 | 3-1376391-4 | 1376397-1 | □-1376385-□ |

Note: Dimensions shown are metric.

Note: All part numbers are RoHS Compliant.

5.0 mm Power Key Connectors .197 [5.00] Centerline Standard Density

5.0 mm Power Key Connectors (5.0 PKC) (Wire-to-Board) (Continued)

**Plug Housing (2 Rows)
(For Receptacle Contacts)**

Material and Finish
Housing—6/6 Nylon, glass filled

Related Product Data

Receptacle Contacts—page 137

Double Lock Plates—page 137

Mating Headers—page 141



Type of Keying/Color



| No. of Pos. | Dimensions | | Plug Housing Part No. | | | | Applicable Double Lock Plate Part Number | Mating Header Assy. Part Number |
|-------------|------------|----|-----------------------|-------------|-------------|---------------|--|---------------------------------|
| | A | B | Type of Keying/Color | | | | | |
| | | | Type A Natural | Type B Red | Type C Blue | Type D Yellow | | |
| 4 | 15 | — | 1376392-1 | 1-1376392-2 | 2-1376392-3 | 3-1376392-4 | 1376394-1 | □-1376386-□ |
| 6 | 20 | 10 | 1376393-1 | 1-1376393-2 | 2-1376393-3 | 3-1376393-4 | 1376395-1 | □-1376387-□ |

Note: Dimensions shown are metric.

Note: All part numbers are RoHS Compliant.

5.0 mm Power Key Connectors (5.0 PKC) (Wire-to-Board) (Continued)

Vertical Header Assembly

Material and Finish
Housing—6/6 Nylon, glass filled
Tab Contacts -Copper Alloy, Tin plated

Related Product Data
Mating Plug Housings—page 138

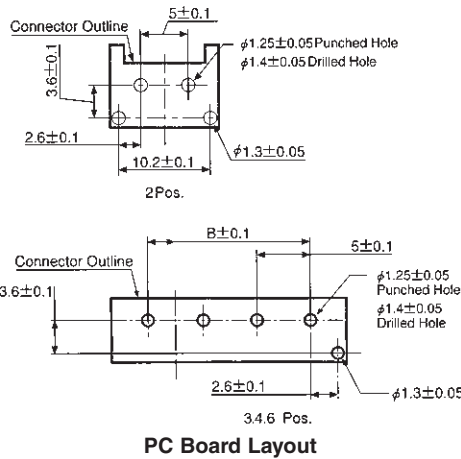

Type of Keying/Color

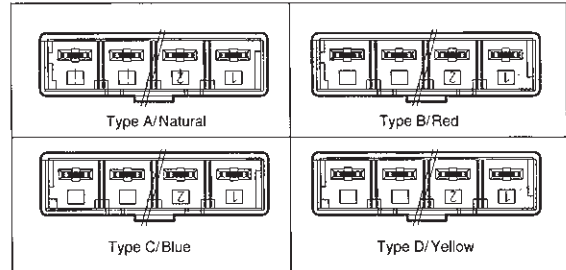

| No. of Pos. | Dimensions | | Loose Piece Tube (Qty.) | Vertical Header Assy. Part No. Type of Keying/Color | | | | Mating Plug Housing Part Number |
|-------------|------------|----|----------------------------|--|------------------|------------------|------------------|---------------------------------|
| | A | B | | Type A Natural | Type B Red | Type C Blue | Type D Yellow | |
| 2 | 11.6 | — | L.P. | 1376382-1 | 1-1376382-2 | 2-1376382-3 | 3-1376382-4 | □-1376388-□ |
| | | | Tube | 1376437-1 (40) | 1-1376437-2 (40) | 2-1376437-3 (40) | 3-1376437-4 (40) | |
| 3 | 16.6 | 10 | L.P. | 1376383-1 | 1-1376383-2 | 2-1376383-3 | 3-1376383-4 | □-1376389-□ |
| | | | Tube | 1376439-1 (25) | 1-1376439-2 (25) | 2-1376439-3 (25) | 3-1376439-4 (25) | |
| 4 | 21.6 | 15 | L.P. | 1376384-1 | 1-1376384-2 | 2-1376384-3 | 3-1376384-4 | □-1376390-□ |
| | | | Tube | 1376440-1 (20) | 1-1376440-2 (20) | 2-1376440-3 (20) | 3-1376440-4 (20) | |
| 6 | 31.6 | 25 | L.P. | 1376385-1 | 1-1376385-2 | 2-1376385-3 | 3-1376385-4 | □-1376391-□ |
| | | | Tube | 1376441-1 (15) | 1-1376441-2 (15) | 2-1376441-3 (15) | 3-1376441-4 (15) | |
| 2* | 16.6 | 10 | L.P. | 1376421-1 | 1-1376421-2 | 2-1376421-3 | 3-1376421-4 | □-1376389-□ |
| | | | Tube | 1376444-1 (25) | 1-1376444-2 (25) | 2-1376444-3 (25) | 3-1376444-4 (25) | |

*10 mm centerline

Note: Dimensions shown are metric.

Note: All part numbers are RoHS Compliant.

Standard Density
5.0 mm Power Key Connectors
.197 [5.00] Centerline

5.0 mm Power Key Connectors (5.0 PKC) (Wire-to-Board) (Continued)

**Vertical Header Assembly
(2 Rows)**

Material and Finish

Housing—6/6 Nylon, glass filled

Tab Contacts—Copper Alloy, Tin plated

Related Product Data

Mating Plug Housings—page 139



Type of Keying/Color



| No. of Pos. | Dimensions | | Loose Piece Tube (Qty.) | Vertical Header Assy. Part No. Type of Keying/Color | | | | Mating Plug Housing Part Number |
|-------------|------------|----|-------------------------------|--|------------------|------------------|------------------|---------------------------------|
| | A | B | | Type A Natural | Type B Red | Type C Blue | Type D Yellow | |
| 4 | 11.6 | — | L.P. | 1376386-1 | 1-1376386-2 | 2-1376386-3 | 3-1376386-4 | □-1376392-□ |
| | | | Tube | 1376442-1 (40) | 1-1376442-2 (40) | 2-1376442-3 (40) | 3-1376442-4 (40) | |
| 6 | 16.6 | 10 | L.P. | 1376387-1 | 1-1376387-2 | 2-1376387-3 | 3-1376387-4 | □-1376393-□ |
| | | | Tube | 1376443-1 (25) | 1-1376443-2 (25) | 2-1376443-3 (25) | 3-1376443-4 (25) | |

Note: Dimensions shown are metric.

Note: All part numbers are RoHS Compliant.

Engineering Notes



.093 [2.36] Commercial Pin and Socket Connectors

Product Facts

- Polarized
- Cavity identification
- Low contact-mating force
- Dual locking lances
- Detent and positive locking
- Contacts available in brass and phosphor bronze with tin and gold plating
- Panel mounting and free-hanging styles
- “F” crimp contacts
- Applicator and hand tool available
- Economical commercial-grade connectors
- Compatible with high-speed application machinery and competitive soft shells
- Wire range 24 to 14 AWG [0.2 to 2 mm²]
- Accepts wires with insulation diameters as large as .180 [4.57]
- Housings available in 1 to 15 positions
- .093 plug and receptacle housings accept pin or socket contacts. The preferred convention is to use socket contacts with receptacle housings
- Not for interrupting current
- Recognized under the Component Program of Underwriters Laboratories Inc., File No. E28476 
- Certified by Canadian Standards Association, File No. LR 7189 

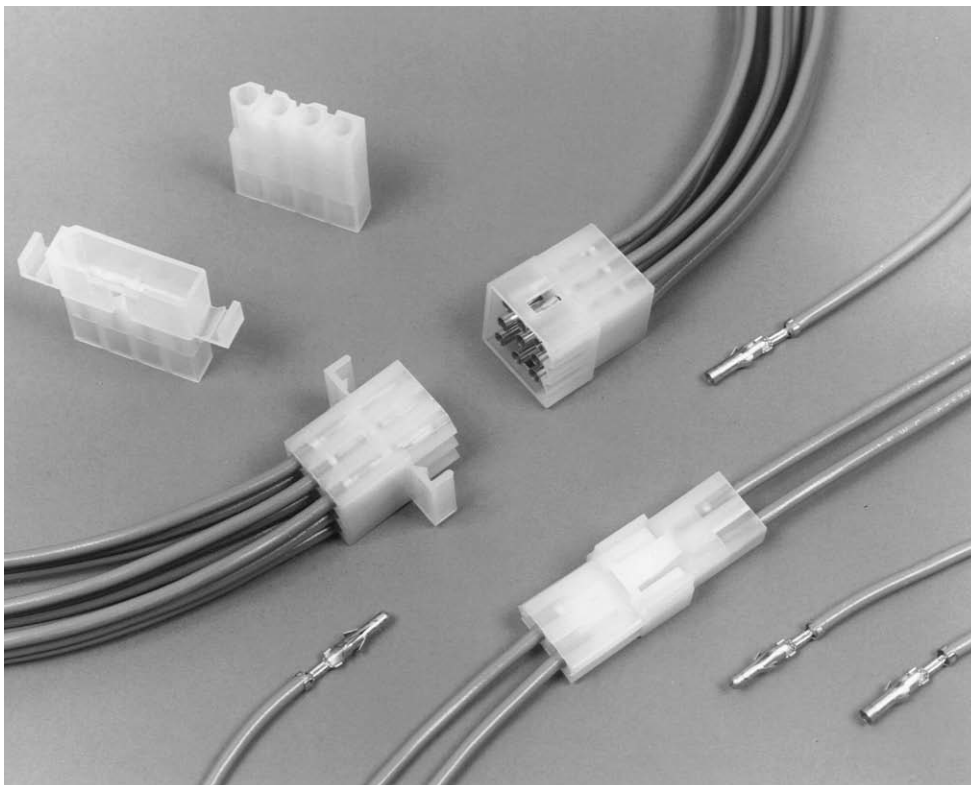

Performance Characteristics

The .093 Commercial Pin and Socket Connectors performance characteristics found on pages 143-144 are based on free-hanging and panel mount connectors, loaded with contacts crimped on stranded wire.

Thermal Shock— -55°C to +105°C

Temperature-Humidity Cycling— +25°C to +65°C at 90–95% RH

Corrosion—48 hr. at 5% salt concentration

Vibration—10-55-10 cycles per minute at .06 [1.52] total excursion

Physical Shock—18 shocks, 50 Gs sawtooth in 11 milliseconds

Durability—50 mating cycles

Dielectric Withstanding Voltage— 1.0 kVAC

Insulation Resistance— 1000 megohms min. initial

Voltage Rating—250 V AC or DC

Connector Mating— 2.5 lb. [11.1 N] max. per contact

Connector Unmating— 1.5 lb. [6.7 N] min. per contact

Contact Retention— 10 lb. [44.5 N] min.

Technical Documents

Application Specification
114-49000 .093 Commercial Pin and Socket Connectors

Product Specification
108-1038 .093 Commercial Pin and Socket Connectors

Standard Density

.093 [2.36] Commercial Pin and Socket Connectors
.198 [5.03] Centerline

.093 [2.36] Commercial Pin and Socket Connectors (Continued)

Performance Characteristics (continued)

Maximum Current—Maximum current rating of .093 Commercial Pin and Socket Connectors is limited by the maximum operating temperature of the housings which is 105°C including the temperature rise of the contacts which is a maximum of 30°C. There are several variables which have a direct effect on this maximum current-carrying capability for a given connector and must be considered for each application. These variables are:

Wire Size—Larger diameter wire will carry more current since it has less internal resistance to current flow and thus generates less heat. Longer wire lengths also enhance current-carrying capabilities since the wire conducts heat away from the connector.

Connector Size—In general, the more circuits in a connector, the less current can be carried.

Ambient Temperature—The higher the ambient temperature, the less current can be carried in any given connector.

Related Product Data

Product Specification — 108-1038

Current Rating Verification for 30°C Maximum Temperature Rise 100% Energized

Wire-to-Wire

.093 Commercial Pin and Socket Connectors — Calculated Current Table

| Number of Circuits | Wire AWG | | | | | |
|--------------------|----------|-------|-------|------|------|------|
| | 14 | 16 | 18 | 20 | 22 | 24 |
| 2 | 13.00 | 12.00 | 11.00 | 8.00 | 6.00 | 6.00 |
| 3 | 13.00 | 11.00 | 10.00 | 8.00 | 6.00 | 5.00 |
| 4 In-Line | 11.00 | 10.00 | 9.00 | 7.00 | 5.00 | 4.00 |
| 4 Matrix | 11.00 | 10.00 | 9.00 | 7.00 | 5.00 | 4.00 |
| 5 | 10.00 | 9.00 | 8.00 | 6.00 | 5.00 | 4.00 |
| 6 | 10.00 | 9.00 | 8.00 | 6.00 | 4.00 | 4.00 |
| 9 | 9.00 | 7.00 | 6.00 | 5.00 | 4.00 | 3.00 |
| 12 | 8.00 | 7.00 | 6.00 | 4.00 | 3.00 | 3.00 |
| 15 | 7.00 | 6.00 | 5.00 | 4.00 | 3.00 | 3.00 |

Values are based on initial Temperature Rise versus Current Testing and are intended to be a guide in the selection of a connector family. All applications should be tested by the end user. The values listed are per circuit for fully loaded housings being 100% energized. **Note:** All combinations were not tested and this chart contains interpolated and extrapolated values.

Minimum Wire Lengths for T-Rise vs. Current Testing

| AWG | Min. Length (in.) | AWG | Min. Length (in.) |
|-----|-------------------|-----|-------------------|
| 30 | 2.6 | 18 | 9.4 |
| 28 | 3.2 | 16 | 11.3 |
| 26 | 4.1 | 14 | 13.7 |
| 24 | 5.1 | 12 | 16.4 |
| 20 | 7.8 | 10 | 19.3 |

Note: If wire lengths used are less than those listed above, the current-carrying ability of the system will be reduced due to less heat being conducted away from the connector. The customer should fully test all applications.

Termination Resistance/Contact Crimp Tensile Force

| Wire Size | | Termination Resistance | | Contact Crimp Tensile Force | |
|-----------|-----------------|------------------------|-----------------------------------|-----------------------------|-------|
| AWG | mm ² | Test Current (Amps) | Resistance Milliohms (Max. Init.) | Force (Min.) | |
| | | | | lbs. | N |
| 24 | 0.2 | 2.0 | 4.0 | 8 | 35.6 |
| 22 | 0.3–0.4 | 3.0 | 4.0 | 10 | 44.5 |
| 20 | 0.5–0.6 | 4.5 | 4.0 | 15 | 66.7 |
| 18 | 0.8–0.9 | 6.0 | 3.5 | 25 | 111.2 |
| 16 | 1.25–1.4 | 8.0 | 3.5 | 25 | 111.2 |
| 14 | 2 | 10.0 | 3.0 | 30 | 133.4 |

Note: This is the total resistance between wire crimps of a mated pin and socket.

.093 [2.36] Commercial Pin and Socket Connectors (Continued)

Contacts

Pin Diameter .093 [2.36]

Material

.010 [0.25] Stock Thickness
Pin and socket contacts can be used in either plug or receptacle housings.

Related Product Data

Product Specification — 108-1038

Application Specification
114-49000

Performance Characteristics —
pages 143-144

Housings

.198 [5.03] Centerline—pages 146-147
.250 [6.35] Centerline—pages 148-149

Panel Cutouts

.198 [5.03] Centerline Housings—
page 147
.250 [6.35] Centerline Housings—
page 148

Technical Documents—pages 143
and 205-206

Application Tooling—pages 207-210

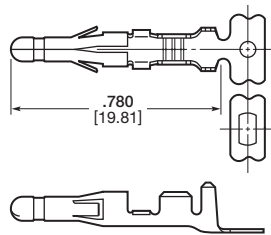

Pin

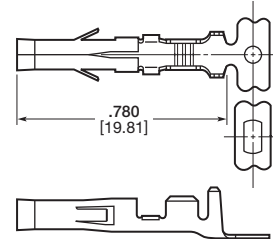

Socket



Pin
Part No. 770385-1



Socket
Part No. 770383-1



Contact Insertion Tool
(For Pins and Sockets)
Part No. 91002-1
IS 408-7347



Contact Extraction Tool
Part No. 318837-1
IS 408-4375

| Wire Size AWG | mm ² | Ins. Dia. | Material & Finish | Contact Part Numbers | | | | HDM Applicator Part No. | Hand Tool Part No. |
|--------------------------|-------------------------------|--------------|---------------------------------|-----------------------|-----------------------|-----------------------|-----------------------|-------------------------|--------------------|
| | | | | Pin | | Socket | | | |
| | | | | Strip Form | Loose Piece | Strip Form | Loose Piece | | |
| 24-18 | 0.2-0.9 | .110 2.79 | Brass, Pre-tin | 350418-1 | 770147-1 | 350417-1 | 770146-1 | 466656-15 | 90872-1 |
| | | | Brass, Gold ² | — | — | 350417-3 ² | 770146-3 ² | 466656-3 ⁵ | |
| | | | Brass Select Gold ¹ | 350418-5 ¹ | 770147-5 ¹ | 350417-5 ¹ | 770146-5 ¹ | | |
| 20-14 | 0.6-2 | .140 3.56 | Brass, Pre-tin | 350416-1 | 770145-1 | 350415-1 | 770144-1 | 466878-15 | 90871-1 |
| | | | Brass, Select Gold ¹ | 350416-5 ¹ | 770145-5 ¹ | 350415-5 ¹ | 770144-5 ¹ | 466878-2 ⁵ | |
| | | | Phos. Brz., Pre-tin | — | — | 350415-6 | 770144-6 | 466878-3 ⁵ | |
| 18-14 or 2 (18) | 0.8-2 or 2 (0.8-0.9) | .180 4.57 | Brass, Pre-tin | 770530-1 ⁴ | — | 770529-1 ⁴ | — | 567337-3 ⁶ | — |
| | | | Phos. Brz., Pre-tin | — | — | 770529-1 ⁴ | — | 567337-4 ⁶ | |
| 18-14 or 2 (18) | 0.8-2 or 2 (0.8-0.9) | .180 4.57 | Brass, Pre-tin | 770385-1 ³ | — | — | — | 567273-2 ⁷ | — |
| | | | Phos. Brz., Pre-tin | — | — | 770383-1 ³ | — | 567273-3 ⁷ | |
| | | | | | | | | 567273-4 ⁷ | |

¹Select Gold — .000030 [.000762] min gold in mating area over .000050 [.00127] min nickel.
²Gold — .000030 [.000762] min gold in mating area, overall gold flash over .000050 [.00127] min nickel.
³These contacts have a .0125 [.318] stock thickness and accept two wires, each with maximum .180 [4.57] insulation diameters. They can be used only with the following housing part numbers: 770364-1, 770365-1, 770450-1, 770451-1, 770452-1, and 770453-1 (see page 143).
⁴Contact length is .875 [22.23]
⁵HDM Applicator part number ending in -1 is used on AMPOMATOR CLS Machine with T or G Terminators, -2 is used on AMP-O-LECTRIC Model K Machine, -3 is used on AMP-O-LECTRIC Model G Machine. See pages 207-210 for further information.
⁶HDM Applicator part number ending in -3 is used on AMPOMATOR CLS Machine with T or G Terminators, -4 is used on AMP-O-LECTRIC Model K Machine, -6 is used on AMP-O-LECTRIC Model G Machine. See pages 207-210 for further information.
⁷HDM Applicator part number ending in -3 is used on AMPOMATOR CLS Machine with T or G Terminators, -2 is used on AMP-O-LECTRIC Model K Machine, -4 is used on AMP-O-LECTRIC Model G Machine. See pages 207-210 for further information.

Note: Phosphor bronze contacts should be used in high-temperature/humidity cycling applications.

Note: All part numbers are RoHS Compliant.

.093 [2.36] Commercial Pin and Socket Connectors (Continued)

Housings

Free-Hanging or Panel Mount

.198 [5.03] Centerline spacing

Material

Housing—Nylon, natural color

Flammability Rating—

UL94-V-2

Related Product Data

Contacts—page 145

Product Specification—108-1038

1 Circuit



Receptacle

Plug

2, 3, and 4 Circuit, In-Line



Receptacle

Plug

| No. of Circuits | A Dimension | | Receptacle Part Numbers | | | | Plug Part Numbers | |
|-----------------|----------------|----------------|-------------------------|--------------|-----------------|--|-----------------------------------|-----------------------|
| | Receptacle | Plug | Panel Mount | | Free-Hanging | | Panel Mount | Free-Hanging |
| | | | Without Detents | With Detents | Without Detents | With Detents | | |
| 1 | — | — | — | — | — | 770063-1 | — | 770064-1 |
| 2 | .540 13.72 | .640 16.26 | — | 770066-11,5 | — | 770065-11,5 770266 ^{1,3,5} | 770068-1 ¹ | 770069-1 ¹ |
| 3 | .670 17.02 | .770 19.56 | — | 770071-1 | — | 770070-1 770264-1 ³ | 770073-1 | 770074-1 |
| 4 (In-Line) | .870 22.10 | .970 24.64 | — | 770076-1 | — | 770075-1 | 770077-1 | 770078-1 |
| 4 (Matrix) | .443 11.25 | .540 13.71 | — | — | — | 770843-1 | — | 770842-1 |
| 5 | 1.070 27.18 | 1.170 29.72 | — | — | — | 770083-1 794015-1 ³ | — | 770084-1 |
| 6 (In-Line) | 1.268 32.21 | 1.378 35.00 | — | — | — | 770782-1 ⁴ | — | 770892-1 ⁴ |
| 6 (Matrix) | .435 11.05 | .535 13.59 | 770085-1 | 770087-1 | 770088-1 | 770086-1 | 770089-1 | 770090-1 |
| 9 | .670 17.02 | .770 19.56 | 770091-1 | 770093-1 | 770094-1 | 770092-1 | 770095-1 ² 770108-1 | 770096-1 |
| 12 | .870 22.10 | .970 24.64 | 770097-1 | 770099-1 | 770100-1 | 770098-1 | 770101-1 | 770102-1 |
| 15 | 1.070 27.18 | 1.170 29.72 | 770103-1 | — | 770105-1 | — | 770106-1 | 770107-1 |

¹2.248 [6.30] centerline.

²Mounting ears at wire end.

³Tool removable.

⁴Positive lock.

⁵600 V AC or DC

Note: All part numbers are RoHS Compliant.

Standard Density

.093 [2.36] Commercial Pin and Socket Connectors
.198 [5.03] Centerline

.093 [2.36] Commercial Pin and Socket Connectors (Continued)

Housings

Free-Hanging or Panel Mount

.198 [5.03] Centerline spacing

Material

Housing—Nylon, natural color

Flammability Rating—
UL94V-2

Related Product Data

Contacts—page 145

Product Specification—108-1038

5 Circuit, In-Line



Receptacle (Free-Hanging)



Plug (Free-Hanging)

4, 6, 9, 12, and 15 Circuit, Matrix

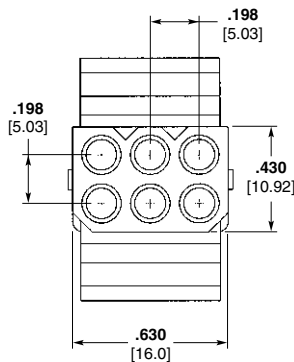

Receptacle



Plug

Recommended Panel Cutouts

Maximum panel thickness is
.090 [2.29].

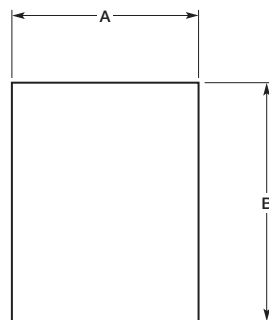

| No. of Circuits | Panel Cutout Dimensions | | | |
|-----------------|-------------------------|----------------|---------------|----------------|
| | Receptacle | | Plug | |
| | A | B | A | B |
| 2 | .312 7.92 | .725 18.42 | .375 9.53 | .800 20.32 |
| 3 | .312 7.92 | .840 21.34 | .375 9.53 | .933 23.70 |
| 4 (In-Line) | .312 7.92 | 1.038 26.37 | .375 9.53 | 1.131 28.73 |
| 6 | .600 15.24 | .718 18.24 | .695 17.65 | .750 19.05 |
| 9 | .725 18.42 | .828 21.03 | .660 16.76 | .937 23.80 |
| 12 | .725 18.42 | 1.050 26.67 | .760 19.30 | 1.155 29.34 |
| 15 | .655 16.64 | 1.240 31.50 | .760 19.30 | 1.343 34.11 |

Note: The panel should be punched so that the housing enters in the same direction as the punch.

.093 [2.36] Commercial Pin and Socket Connectors (Continued)

Housings

Free-Hanging or Panel Mount

.250 [6.35] Centerline spacing

Material

Housing—Nylon, natural color

Flammability Rating—
UL94V-2

Voltage Rating—600 V AC or DC

Related Product Data

Contacts—page 145

Product Specification—108-1038

3 Circuit, In-Line



4 Circuit, In-Line



6 Circuit, Matrix



Recommended Panel Cutouts

Maximum panel thickness is
.062 [1.57].

Note: The panel should be punched so that the housing enters in the same direction as the punch.



| No. of Circuits | Receptacle Part Numbers | | Plug Part Numbers | |
|-----------------|-----------------------------------|--------------|-------------------|--------------|
| | Panel Mount | Free-Hanging | Panel Mount | Free-Hanging |
| 3 | 770269-1 770771-1 ¹ | 770339-1 | 770338-1 | 770276-1 |
| 4 | 770329-1 | 770337-1 | 770330-1 | 770336-1 |
| 6 | 770372-1 | 770360-1 | 770373-1 | 770361-1 |

¹Pre-bent mounting ears.

| No. of Circuits | Panel Cutout Dimensions | | | |
|-----------------|-------------------------|----------------|---------------|----------------|
| | Receptacle | | Plug | |
| | A | B | A | B |
| 3 | .310 7.87 | .920 23.37 | .365 9.27 | 1.022 25.96 |
| 4 | .310 7.87 | 1.168 29.67 | .365 9.27 | 1.270 32.26 |
| 6 | .608 15.44 | .946 24.03 | .658 16.71 | 1.048 26.62 |

Note: All part numbers are RoHS Compliant.

Standard Density

.093 [2.36] Commercial Pin and Socket Connectors
.198 [5.03] Centerline

.093 [2.36] Commercial Pin and Socket Connectors (Continued)

Housings

Free-Hanging or Panel Mount

.250 [6.35] Centerline spacing

Material

Housing—Nylon, natural color

Flammability Rating—
UL94V-2

Voltage Rating—600 V AC or DC

Related Product Data

Contacts—page 145

Product Specification—108-1038

Dual Wire

2 Circuit, In-Line



3 Circuit, In-Line



| No. of Circuits | Receptacle Part Numbers | | Plug Part Numbers | |
|-----------------|-------------------------|-----------------------|-----------------------|-----------------------|
| | Panel Mount | Free-Hanging | Panel Mount | Free-Hanging |
| 2 | — | 770364-1 ¹ | — | 770365-1 ¹ |
| 3 | 770453-1 ² | 770451-1 | 770452-1 ² | 770450-1 |

¹1.248 [6.30] centerline.

²See panel cutout dimensions on page 58.

Positive Lock

2, 3 and 4 Circuit, In-Line



| No. of Circuits | Receptacle Part Numbers | | Plug Part Numbers | |
|-----------------|-------------------------|--|-----------------------|--|
| | Free-Hanging | | Free-Hanging | |
| 2 | 770424-1 ¹ | | 770425-1 ¹ | |
| 3 | 770785-1 | | 770783-1 | |
| 4 | 770784-1 | | 770810-1 | |

¹1.248 [6.30] centerline.

Note: All part numbers are RoHS Compliant.

Engineering Notes



Commercial MATE-N-LOK Connectors

Product Facts

- Fully polarized nylon housings
- Easy cavity identification
- Locking devices are integral part of design. Connector halves will hold together under severe conditions of vibration and shock
- Built-in contact stabilization and self-aligning features
- Hot side egg-crate design for safety
- Precision molded to exacting tolerances
- Contacts accept a wire size range of 30-14 AWG [.05-2.0 mm²]
- Keying plug available
- “Clean” design contact—no sharp projections to impede insertion or damage housings
- Low insertion/extraction forces
- Contacts available in pre-tin or gold over nickel plated to fit the application requirements
- Wire-to-PC Board capability using pin or socket headers
- Solderability—Headers meet MIL-STD 202 method 208
- Four circuit PC Board-to-PC Board capability available by mating vertical socket header with either vertical, right-angle or surface mount pin header
- Four circuit insulation displacement connector (IDC) available
- Ultraviolet (UV) stable housings available in 1, 2 and 3 circuit
- Not for interrupting current
- Recognized under the Component Program of Underwriters Laboratories Inc., File No. E28476
- Certified by Canadian Standards Association, File No. LR 7189A



Performance Characteristics

The Commercial MATE-N-LOK Connector performance characteristics found on pages 151-152 are based on free-hanging and panel mount connectors, loaded with contacts crimped on stranded wire.

Dielectric Withstanding Voltage—1.5 KVAC between adjacent circuits

Insulation Resistance—500 megohms minimum initial between adjacent circuits

Voltage Rating—250 V AC or DC

Connector Mating—4 lb. max. per circuit

Connector Unmating—0.7 lb. min. per circuit

Contact Retention—15 lb. min. per contact

Durability—50 cycles, mating and unmating

Technical Documents

Product Specifications

108-1000 Commercial MATE-N-LOK Connectors

108-1077 Commercial MATE-N-LOK PC Board Headers

108-49000 IDC Connectors

Application Specifications

114-1012 Commercial MATE-N-LOK Contacts

114-49001 IDC Connectors

Instruction Sheets

408-7209, 408-7166, 408-7200, 408-7201, 408-7215, 408-3186, 408-7300

Commercial MATE-N-LOK Connectors (Continued)

Performance Characteristics (Continued)

Maximum Current—Maximum current rating of Commercial MATE-N-LOK connectors is limited by the maximum operating temperature of the housings which is 105°C including the temperature rise of the contacts which is a maximum of 30°C. There are several variables which have a direct effect on this maximum current-carrying capability for a given connector and must be considered for each application. These variables are:

Wire Size—Larger diameter wire will carry more current since it has less internal resistance to current flow and thus generates less heat. Longer wire lengths also enhance current-carrying capabilities since the wire conducts heat away from the connector.

Connector Size—In general, the more circuits in a connector, the less current can be carried.

Ambient Temperature—The higher the ambient temperature, the less current can be carried in any given connector.

Printed Wiring Board Conductor Size—The finished trace conductor width and thickness should be maximized to allow for the greatest current-carrying capacity and heat dissipation.

Commercial MATE-N-LOK connectors also will withstand the following tests:

Vibration—10-55-10 cycles per minute at .06 inch total excursion

Physical Shock—18 drops, 50 G sawtooth at 11 milliseconds

Housing Panel Mount Retention—40 lb. min. 3 and 4 circuit
65 lb. min. 6, 9, 12, and 15 circuit

Housing Lock Strength with Positive Locking Devices Engaged—25 lb. min.

Thermal Shock—-55°C to +85°C

Temperature-Humidity Cycling—25°C to 65°C at 95 RH

Corrosion—48 hr. at 5% salt concentration

Related Product Data

Product Specifications

- 108-1000 Commercial MATE-N-LOK Connectors
- 108-1077 Commercial MATE-N-LOK PC Board Headers

Current Rating Verification for 30°C Maximum Temperature Rise 100% Energized

Wire-to-Wire

Motor Mount Calculated Current Table

| Number of Circuits | Wire Gauge | | | | | | |
|--------------------|------------|-------|------|------|------|------|------|
| | 14 | 16 | 18 | 20 | 22 | 24 | 30 |
| 6 | 13.00 | 10.50 | 9.50 | 7.50 | 6.00 | 5.00 | 2.50 |
| 8 | 12.00 | 9.50 | 8.50 | 7.00 | 5.50 | 4.50 | 2.50 |
| 10 | 11.00 | 9.00 | 8.00 | 6.50 | 5.00 | 4.50 | 2.00 |
| 12 | 10.50 | 8.50 | 7.50 | 6.00 | 5.00 | 4.00 | 2.00 |
| 16 | 9.50 | 8.00 | 7.00 | 5.50 | 4.50 | 3.50 | 2.00 |

Values are based on initial Temperature Rise versus Current Testing and are intended to be a guide in the selection of a connector family. All applications should be tested by the end user. The values listed are per circuit for fully loaded housings being 100% energized. **Note:** All combinations were not tested, and this chart contains interpolated and extrapolated values.

Calculated Current Table

| Number of Circuits | Wire Gauge | | | | | | |
|--------------------|------------|-------|-------|-------|------|------|------|
| | 14 | 16 | 18 | 20 | 22 | 24 | 30 |
| 1 | 19.00 | 15.50 | 14.00 | 11.00 | 9.00 | 7.50 | 4.00 |
| 2 | 18.00 | 14.50 | 13.00 | 10.50 | 8.50 | 7.00 | 4.00 |
| 3 | 16.00 | 13.00 | 12.00 | 9.50 | 7.50 | 6.50 | 3.50 |
| 4 | 15.00 | 12.50 | 11.00 | 9.00 | 7.00 | 6.00 | 3.00 |
| 6 Matrix | 13.00 | 10.50 | 9.50 | 7.50 | 6.00 | 5.00 | 3.00 |
| 8 | 12.50 | 10.50 | 9.00 | 7.50 | 6.00 | 5.00 | 2.50 |
| 9 | 11.00 | 9.00 | 8.00 | 6.50 | 5.50 | 4.50 | 2.50 |
| 10 | 12.00 | 9.50 | 8.50 | 7.00 | 5.50 | 4.50 | 2.50 |
| 12 | 10.50 | 8.50 | 7.50 | 6.00 | 5.00 | 4.00 | 2.00 |
| 15 | 9.50 | 8.00 | 7.00 | 5.50 | 4.50 | 4.00 | 2.00 |

Values are based on initial Temperature Rise versus Current Testing and are intended to be a guide in the selection of a connector family. All applications should be tested by the end user. The values listed are per circuit for fully loaded housings being 100% energized. **Note:** All combinations were not tested, and this chart contains interpolated and extrapolated values.

Wire-to-Board

Due to the vast differences in trace geometry and printed circuit board configurations, we are unable to provide a separate current carrying chart for our printed circuit board header products. However, the above Wire-to-Wire charts may be used as a guideline for headers if the trace width and thickness is equal to the listed wire gauge. For vertical headers, only 95% of the Wire-to-Wire value should be used. For right-angle headers, only 75% of the Wire-to-Wire value should be used. The chart values are only a tool for connector selection and will require the customer to fully test their application.

Minimum Wire Lengths for T-Rise vs. Current Testing

| AWG | Min. Length (in.) | AWG | Min. Length (in.) |
|-----|-------------------|-----|-------------------|
| 30 | 2.6 | 18 | 9.4 |
| 28 | 3.2 | 16 | 11.3 |
| 26 | 4.1 | 14 | 13.7 |
| 24 | 5.1 | 12 | 16.4 |
| 20 | 7.8 | 10 | 19.3 |

Note: If wire lengths used are less than those listed above, the current carrying ability of the system will be reduced due to less heat being conducted away from the connector. The customer should fully test all applications.

Termination Resistance/Contact Crimp Tensile Force

| Wire Size | | Termination Resistance | | Contact Crimp Tensile Force | |
|-----------|-----------------|------------------------|-----------------------------------|-----------------------------|-----|
| AWG | mm ² | Test Current (Amps) | Resistance Milliohms (Max. Init.) | Force (Min.) lbs. | N |
| 30 | .05 | .50 | 4.00 | 2 | 9 |
| 28 | .08 | .75 | 3.50 | 3 | 13 |
| 26 | .12 | 1.00 | 3.50 | 7 | 31 |
| 24 | .2 | 1.5 | 3.50 | 10 | 44 |
| 22 | .3 | 3 | 3.50 | 15 | 67 |
| 20 | .5 | 4.5 | 3.00 | 20 | 89 |
| 18 | .8 | 6 | 3.00 | 30 | 133 |
| 16 | 1.2 | 8 | 2.75 | 30 | 133 |
| 14 | 2.0 | 10 | 2.75 | 35 | 156 |

Note: This is the total resistance between wire crimps of a mated pin and socket.

Standard Density

Commercial MATE-N-LOK Connectors
.200 [5.08] Centerline

Commercial MATE-N-LOK Connectors (Continued)

Commercial MATE-N-LOK Connector Mating Combinations

| Connector Part Number | | | | | Mating Connector Part Number | | | | | | | |
|-----------------------|--|----------|-----------------------------|--------------------|------------------------------|-----------------------------|---------------------|--------------|-----------|-----------------|-----------------|-----------|
| Number of Circuits | Flammability Rating | Style | Housing Type | Connector Part No. | Housing Part No. | Housing Type | PC Board Headers | | | | | |
| | | | | | | | Plating | Vertical Pin | | Right-Angle Pin | Vertical Socket | |
| | | | | | | | Standard Tail | Long Tail | | | Standard Tail | Long Tail |
| 1 | UL94V-2 | In-Line | Socket: FH | 1-480349-0 | 1-480350-0 | Pin: FH | — | — | — | — | — | — |
| | | | Socket: FH UV Stable | 1-480400-0 | 1-480401-1 | Pin: FH UV Stable | — | — | — | — | — | — |
| | | | Socket: FH | 1-480318-0 | 1-480319-0 | Pin: FH | Pre-tin | 350209-1 | 350422-1 | 794120-1 | — | — |
| 2 | UL94V-2 | In-Line | Socket: FH UV Stable | 1-480393-1 | 1-480498-1 | Pin: FH UV Stable | — | — | — | — | — | — |
| | | | Socket: FH Positive Lock | 1-480720-0 | 794012-1 | Pin: FH Positive Lock | Pre-tin | 350539-1 | 350540-1 | — | — | |
| | | | Socket: FH | 1-480303-0 | 1-480305-0 | Pin: FH | Duplex ¹ | 1586512-2 | — | — | — | |
| 3 | UL94V-2 | In-Line | Socket: PM | 1-480304-0 | — | — | — | — | — | — | — | |
| | | | Socket: FH Positive Lock | 1-480721-0 | — | — | Pre-tin | 350210-1 | 350423-1 | 643488-1 | — | |
| | | | Socket: FH UV Stable | 1-480388-0 | 1-480387-0 | Pin: FH UV Stable | Duplex ¹ | 1586514-2 | — | — | — | |
| 4 | See next page for 4 position mating combinations | | | | | | | | | | | |
| 6 | UL94V-2 | Matrix | Socket: FH Positive Lock | 1-480270-0 | 1-480340-0 | Pin: FH Positive Lock | Pre-tin | 1-380999-0 | 350425-1 | — | — | — |
| | | | Socket: PM Positive Lock | 1-480273-0 | 1-480271-0 | Pin: MM Positive Lock | Duplex ¹ | 2-1586546-0 | 1586526-2 | — | — | — |
| | | | Pin: PM Positive Lock | 1-480276-0 | 1-480276-0 | Socket: PM Positive Lock | Pre-tin | — | — | — | 350641-1 | 350576-1 |
| 8 | UL94V-2 | Dual Row | Socket: FH Positive Lock | 1-480283-0 | 1-480345-0 | Pin: FH Positive Lock | Pre-tin | 350212-1 | 350426-1 | — | — | — |
| | | | Pin: PM Positive Lock | 1-480277-0 | 1-480284-0 | Pin: MM Positive Lock | Duplex ¹ | 1586518-2 | 1586528-2 | — | — | — |
| 9 | UL94V-2 | Matrix | Pin: PM Positive Lock | 1-480277-0 | 1-480274-0 | Socket: PM Positive Lock | Pre-tin | — | — | — | 350642-1 | 350577-1 |
| | | | Socket: FH Positive Lock | 1-480285-0 | 1-480339-0 | Pin: FH Positive Lock | Duplex ¹ | — | — | — | — | — |
| 10 | UL94V-2 | Dual Row | Socket: FH Positive Lock | 1-480285-0 | 1-480286-0 | Pin: MM Positive Lock | Pre-tin | 1-380991-0 | 350219-1 | — | — | — |
| | | | Socket: MM Positive Lock | 1-480287-0 | 1-480288-0 | Pin: MM Positive Lock | Duplex ¹ | 2-1586544-0 | — | — | — | — |
| 12 | UL94V-2 | Dual Row | Socket: MM Positive Lock | 1-480287-0 | 1-480275-0 | Socket: PM Positive Lock | Pre-tin | 350213-1 | 350220-1 | — | — | — |
| | | | Pin: PM Positive Lock | 1-480278-0 | 1-480275-0 | Socket: PM Positive Lock | Duplex ¹ | 1586520-2 | 1586524-2 | — | — | — |
| 15 | UL94V-2 | Matrix | Pin: PM Positive Lock | 1-480324-0 | 1-480323-0 | Socket: PM Positive Lock | Pre-tin | — | — | — | 350643-1 | 350578-1 |
| | | | Socket: MM Positive Lock | 1-480438-0 | 1-480439-0 | Pin: MM Positive Lock | Duplex ¹ | — | — | — | — | — |
| 16 | UL94V-2 | Dual Row | Socket: MM Positive Lock | 1-480438-0 | 1-480439-0 | Pin: MM Positive Lock | Pre-tin | 350644-1 | 350579-1 | — | — | — |
| | | | Socket: MM Positive Lock | 1-480438-0 | 1-480439-0 | Pin: MM Positive Lock | Duplex ¹ | 1586522-2 | 1586529-2 | — | — | — |

FH: Free-Hanging

PM: Panel Mount

MM: Motor Mount

¹Duplex Finish — Plated with .000030 [.000762] min. gold in mating area, matte tin on solder tail end over .000050 [.00127] min. nickel underplate on entire contact.

Note: All part numbers are RoHS Compliant.

Commercial MATE-N-LOK Connectors (Continued)

Commercial MATE-N-LOK 4 Position In-Line Mating Combinations (Note: These connectors are used by the disk drive industry.)

| Connector Part Number | | | Mating Connector Part Number | | | | | | | | | | | | | | |
|-----------------------|---|--|------------------------------|------------------|--------------------------------|--|-----------------------|---------------------------------|------------------------|----------------------|----------------------|----------|--------------------------|---------------------------|---|---|---|
| Flammability Rating | Connector Type | Connector Part No. | Socket Connectors | | | | | PC Board Pin Headers | | | | | | | | | |
| | | | Housing Part No. | Housing Type | Plating | Insulation Displacement Connector | AWG | PC Board Vertical Socket Header | Vertical Standard Tail | Vertical Long Tail | Surface Mount | Standard | Right-Angle W/Fixed Belt | W/Fixed Belt Reverse Pol. | | | |
| | Socket Housing Positive Lock | 1-480772-0 | — | — | Pre-tin Duplex ¹ | — | — | 350543-1 1586534-2 | 350544-1 1586536-2 | — | — | — | — | — | — | — | |
| | Socket Housing Detent Lock | 1-480424-0 | 1-480426-0 | Pin | Pre-tin | — | — | 350211-1 770328-13 | 350424-1 770829-1 | 641737-1 770846-1 | 174804-1 | 174552-1 | — | — | — | — | |
| UL94V-2 | Pin Housing Detent Lock | 1-480426-0 | 1-480424-0 | Socket | Pre-tin | 770156-2 22 770156-3 18 770156-4 20 770156-5 16 | 770997-1 794287-12 | — | — | — | — | — | — | — | — | — | — |
| | Pin Housing Detent Lock High Temp | 3-480426-0 | 3-480425-0 | Socket High Temp | — | — | — | — | — | — | — | — | — | — | — | — | — |
| | Socket Header | 770997-1 794287-12 | 1-480426-0 | Pin | Pre-tin | — | — | 350211-1 | 350424-1 | 770829-1 | 641737-1 770846-1 | 174804-1 | 174552-1 | — | — | — | — |
| UL94V-0 | Insulation Displacement Connector (IDC) | 770156-2 770156-3 770156-4 770156-5 | 1-480426-0 | Pin | Pre-tin | — | — | 350211-1 | 350424-1 | 770829-1 | 641737-1 770846-1 | 174804-1 | 174552-1 | — | — | — | — |
| | Socket Housing | 770827-1 | 794132-1 | Pin | Pre-tin | — | — | — | — | — | — | — | — | — | — | — | — |
| | Insulation Displacement Connector (IDC) | 794036-1 794036-2 794036-3 794036-4 | 794132-1 | — | Pre-tin | — | — | — | — | — | — | — | — | — | — | — | — |
| UL94V-0 | Right-Angle Pin Header | 1-641737-1 | 770827-1 | Socket | Pre-tin | 794036-1 18 794036-2 20 794036-3 22 794036-4 16 | — | 794236-1 | — | — | — | — | — | — | — | — | — |

PM: Panel Mount

¹Duplex Finish—Plated with .000030 [.000762] min. gold in mating area, matte tin on solder tail end over .000050 [.00127] min. nickel underplate on entire contact.

²Surface Mount Compatible.

³With Drainholes

Note: All part numbers are RoHS Compliant.

Commercial MATE-N-LOK Connectors (Continued)

Contacts

Pin diameter .084 [2.13]
Stock thickness .012 [.305]
These contacts are to be used in Commercial MATE-N-LOK housings **only**.

Related Product Data

Product Specification

108-1000 Commercial MATE-N-LOK Connectors

Application Specification

114-1012 Commercial MATE-N-LOK Contacts

Performance Characteristics—

pages 151-152

Housings—pages 157-159

Technical Documents—pages 151 and 205-206

Application Tooling—pages 207-210

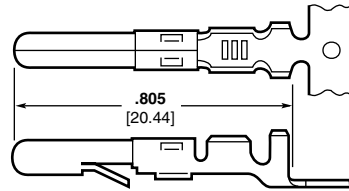

Pin

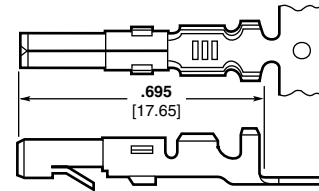

Socket

| Wire Size Range AWG [mm ²] | Ins. Dia. Range | Material & Finish | Contact Part Numbers | | | | HDM Applicator Part No. | Hand Tool Part No. |
|---|-------------------------------|--------------------------------------|----------------------|-------------|------------|-------------|---|---------------------------------|
| | | | Pin | | Socket | | | |
| | | | Strip Form | Loose Piece | Strip Form | Loose Piece | | |
| 30-22 [.05-.3] | .040-.075 1.02-1.91 | Brass, Pre-tin | 350079-1 | 61174-1 | 350078-1 | 61173-1 | 466426-1 ³ 466426-2 ³ 466426-3 ³ | 91515-1 |
| | | Phos. Brz., Pre-tin | 350079-4 | — | 350078-4 | 61173-4 | | |
| | | Brass, Gold ¹ | 350079-5 | 61174-5 | 350078-5 | 61173-5 | | |
| | | Brass, Pre-tin | 61116-1 | 60618-1 | 61314-1 | 60617-1 | | |
| 24-18 [.2-.8] | .060-.100 1.52-2.54 | Phos. Brz., Pre-tin | 61116-4 | 60618-4 | 61314-4 | 60617-4 | 466320-1 ³ 466320-2 ³ 466320-4 ³ | 91512-1 91528-1 ⁴ |
| | | Brass, Gold ¹ | 61116-5 | 60618-5 | 61314-5 | 60617-5 | | |
| | | Phos. Brz., Select Gold ² | 61116-6 | 60618-6 | 61314-6 | 60617-6 | | |
| | | Brass, Select Gold ² | 61116-7 | — | 61314-7 | — | | |
| 20-14 [.5-2.0] | .100-.130 2.54-3.30 | Brass, Pre-tin | 61118-1 | 60620-1 | 61117-1 | 60619-1 | 687763-1 ³ 687763-2 ³ 687763-6 ³ | 91504-1 |
| | | Phos. Brz., Pre-tin | 61118-4 | 60620-4 | 61117-4 | 60619-4 | | |
| | | Brass, Gold ¹ | 61118-5 | 60620-5 | 61117-5 | 60619-5 | | |
| | | Phos. Brz., Gold ¹ | 61118-6 | — | 61117-6 | 60619-7 | | |
| | | Brass, Select Gold ² | 61118-7 | — | 61117-7 | — | | |
| (2) 18 [.8] or (2) .115 Max. (1) 18 [.8] and 2.92 (1) 16 [1.2] (stacked) | | Brass, Pre-tin | 350558-1 | 350639-1 | 350557-1 | — | 687898-1 ³ 687898-2 ³ 687898-4 ³ | 91504-1 |
| | | Phos. Brz., Pre-tin | 350558-4 | — | 350557-4 | 350638-4 | | |

¹Gold Finish—Plated with .000030 [.000762] min. gold in mating area and inside wire barrel over .000050 [.00127] min. nickel underplate on entire contact.

²Select Gold Finish—Plated with .000030 [.000762] min. gold in mating area over .000050 [.00127] min. nickel underplate on entire contact.

³HDM Applicator part number ending in -1 is used on AMPOMATOR CLS Machine with T or G Terminators, -2 is used on AMP-O-LECTRIC Model K Machine; -3, -4, or -6 is used on AMP-O-LECTRIC Model G Machine. See pages 207-210 for further information.

⁴Use Hand Tool No. 91528-1 for .043-.075 [1.09-1.90] insulation diameter.

Notes:

1. Extraction Tools: Pins — No. **1-305183-1** (IS 408-7158); Sockets — No. **1-305183-2** (IS 408-7158); Pins and Sockets — No. **465644-1** (IS 408-7211)
2. Insertion Tools: No. **455830-1** (IS 408-7984)

Commoning Tabs

Material and Finish

Brass, tin plated
Stock thickness .008 [.203]

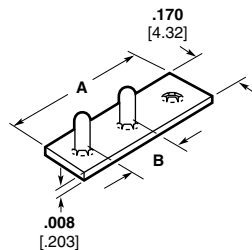

| Number of Holes | Dimensions | | Part Number |
|-----------------|----------------------|---------------------|-------------|
| | A | B | |
| 2 | .377 9.58 | .203 5.16 | 60843-1 |
| 2 | .355 9.02 | .195 4.95 | 350444-1 |
| 3 | .579 14.71 | .203 5.16 | 60842-1 |
| 3 | .550 13.97 | .195 4.95 | 350444-2 |

Note: Commoning tabs are designed to be used with pin housings.

Note: All part numbers are RoHS Compliant.

Commercial MATE-N-LOK Connectors (Continued)

Contacts

Pin diameter .084 [2.13]
Stock thickness .012 [.305]
These contacts are to be used in Commercial MATE-N-LOK housings only.

Related Product Data

Product Specification

108-1000 Commercial MATE-N-LOK Connectors

Application Specification

114-1012 Commercial MATE-N-LOK Contacts

Performance Characteristics—pages 151-152

Housings—pages 157-159

Technical Documents—pages 151 and 205-206

Application Tooling—pages 207-210

PC Board Contacts



Pin

Socket

| Type of Contact | L Dim. | | Material & Finish | Part Numbers | |
|-----------------|------------------|------------------|---------------------|--------------|-------------|
| | Pin | Socket | | Pin | Socket |
| | | | | Loose Piece | Loose Piece |
| PC Board | 1.110 [28.19] | 1.010 [25.65] | Phos. Brz., Pre-tin | 61518-11 | 61320-11 |
| | 1.210 [30.73] | 1.110 [28.19] | Phos. Brz., Pre-tin | 350074-12 | 350073-12 |

¹For .062 [1.57] max. board thickness—Board hole size .057 [1.45]

²For .125 [3.14] max. board thickness—Board hole size .057 [1.45]

Grounding Pin

(.095 [2.41] longer than standard pin)

(Mate first, break last, not for interrupting current)



| Wire Size Range AWG [mm ²] | Ins. Dia. Range | Material & Finish | Contact Part Numbers | | HDM Applicator Part No. | Hand Tool Part No. |
|---|------------------------|-------------------|----------------------|-------------|-------------------------------------|-----------------------|
| | | | Strip Form | Loose Piece | | |
| 24-18 [2-.8] | .060-.100 1.52-2.54 | Brass, Pre-tin | 61527-2 | — | 466320-11 466320-21 466320-41 | 91512-1 |

¹HDM Applicator part number ending in -1 is used on AMPOMATOR CLS Machine with T or G Terminators, -2 is used on AMP-O-LECTRIC Model K Machine; -3, -4, or -6 is used on AMP-O-LECTRIC Model G Machine. See pages 207-210 for further information.

Keying Plug

IS 408-7582

Material

Housing—Nylon, natural color

Flammability Rating—UL94V-2



Part Number
200821-1

Note: Keying plug snaps into socket housing

Note: All part numbers are RoHS Compliant.

Commercial MATE-N-LOK Connectors (Continued)

Housings

Free-Hanging

.200 [5.08] Centerline spacing

Material

Housing—Nylon, natural color

Flammability Rating—UL94V-2

Related Product Data

Product Specification

108-1000 Commercial MATE-N-LOK Connectors

Performance Characteristics—pages 151-152

Contacts—pages 155-156

Commoning Tabs—page 155

Keying Plug—page 156

Technical Documents—pages 151 and 205-206

Mating Pin Headers—pages 161-164

Mating Socket Headers—page 162

Mating IDC—page 163

1 Circuit

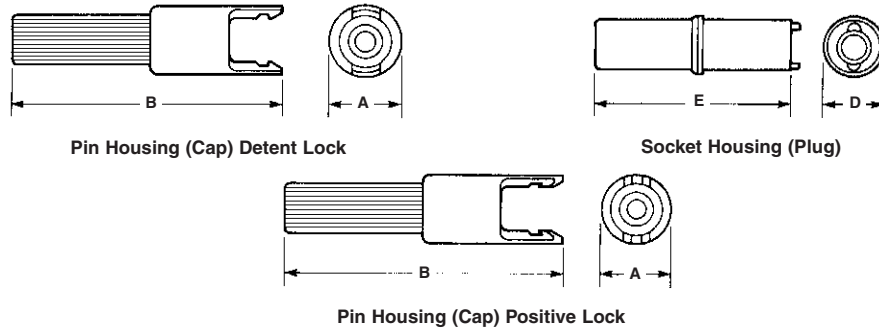

2, 3 and 4 Circuit, In-Line

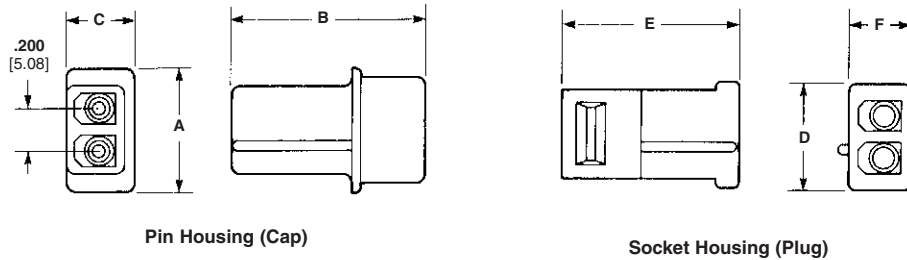

| Number of Circuits | Dimensions | | | | | | Part Numbers | |
|--------------------|------------|-------|------|-------|-------|------|-------------------|-----------------------|
| | A | B | C | D | E | F | Pin Housing (Cap) | Socket Housing (Plug) |
| 1 | .300 | 1.200 | — | .260 | .870 | — | 1-480350-01 | 1-480349-0 |
| | 7.62 | 30.48 | — | 6.60 | 22.10 | — | 1-480351-02 | 1-480349-0 |
| | .300 | 1.240 | — | .260 | .870 | — | 1-480401-01.3 | 1-480400-03 |
| 2 | .300 | 1.325 | — | .260 | .995 | — | 1-480401-01.3 | 1-480400-03 |
| | 7.62 | 33.65 | — | 6.60 | 25.27 | — | 1-480319-01.5 | 1-480318-05 |
| | .610 | .930 | .330 | .530 | .860 | .295 | 1-480498-11.3.5 | 1-480393-13.5 |
| 3 | .610 | .930 | .330 | .530 | .860 | .295 | 1-480305-01.5 | 1-480303-05 |
| | 15.49 | 23.62 | 8.38 | 13.46 | 21.84 | 7.49 | 1-480387-01.3.5 | 1-480388-03.5 |
| | .810 | .930 | .325 | .825 | .850 | .290 | 1-480426-01.5.6 | 1-480424-05.6 |
| 4 | .810 | .930 | .325 | .825 | .850 | .290 | 1-480426-01.5.6 | 1-480424-05.6 |
| | 20.57 | 23.62 | 8.25 | 20.95 | 21.60 | 7.37 | 794132-14.5.6 | 770827-14.5.6 |
| | 1.010 | .930 | .330 | 1.030 | .850 | .310 | | |
| | 25.65 | 23.62 | 8.38 | 26.16 | 21.60 | 7.88 | | |
| | — | — | — | 1.030 | .850 | .310 | | |
| | | | | 26.16 | 21.60 | 7.88 | | |

¹Detent lock

²Positive lock

³UV Stable black color

⁴Housing Material UL94V-0 rated

⁵Housing accepts double wire applications where individual insulation diameters do not exceed .115 [2.92].

⁶Used by the disk drive industry.

Note: All part numbers are RoHS Compliant.

Commercial MATE-N-LOK Connectors (Continued)

Housings
Free-Hanging, Positive Lock

Material

Housing—Nylon, natural color
Flammability Rating—UL94V-2

2, 3, and 4 Circuit, In-Line
.200 [5.08] Centerline spacing



Socket Housing (Plug)

| Number of Circuits | A Dim. | Part Numbers | | |
|--------------------|---------------|-------------------------|---|------------------------|
| | | Socket Housing (Plug) | Mates with Pin Headers | Mates with Cap Housing |
| 2 | .435 11.04 | 1-480720-0 | 350539, 350540 | 794012-1 |
| 3 | .630 16.00 | 1-480721-0 | 350541 | — |
| 4 | .830 21.09 | 1-480722-0 ¹ | 350543 ¹ , 350544 ¹ | — |

¹Used by the disk drive industry.

6 Circuit, Dual Row



Pin Housing (Cap)

Socket Housing (Plug)

8 and 10 Circuit, Dual Row



Pin Housing (Cap)

Socket Housing (Plug)

Related Product Data

Product Specification

108-1000 Commercial MATE-N-LOK Connectors

Performance Characteristics—pages 151-152

Contacts—pages 155-156

Commoning Tabs—page 155

Keying Plug—page 156

Technical Documents—pages 151 and 205-206

Mating Headers—pages 161-164

| Number of Circuits | Dimensions | | Part Numbers | |
|--------------------|----------------|----------------|-------------------|-------------------------|
| | A | D | Pin Housing (Cap) | Socket Housing (Plug) |
| 6 | .705 17.91 | .610 15.49 | 1-480340-0 | 1-480270-01 |
| 8 | .900 22.86 | .805 20.44 | 1-480345-0 | 1-480283-0 ¹ |
| 10 | 1.095 27.81 | 1.000 25.40 | 1-480339-0 | 1-480285-0 ¹ |

¹Housing accepts double wire applications where individual insulation diameters do not exceed .115 [2.92].

Note: All part numbers are RoHS Compliant.

Standard Density

Commercial MATE-N-LOK Connectors
.200 [5.08] Centerline

Commercial MATE-N-LOK Connectors (Continued)

Housings

Panel Mount, Positive Lock

Material

Housing—Nylon, natural color

Flammability Rating—UL94V-2

Related Product Data

Product Specification

108-1000 Commercial MATE-N-LOK Connectors

Performance Characteristics—pages 151-152

Contacts—pages 155-156

Commoning Tabs—page 155

Keying Plug—page 156

Technical Documents—pages 151 and 205-206

Mating Socket Headers—page 162

Mating IDC—page 163

Recommended Panel Cutout for Panel Mount Socket Housing

View is from socket housing entry side

Mounting Information

1. Recommended panel thickness—.025-.065 [.635-1.65].
2. Both locking legs are to be squeezed together and the housing is to be inserted "straight-in", as opposed to a rocking manner.
3. The panel should be punched so that the housing enters the panel in the same direction as the punch.
4. The panel must not have any material (paint, porcelain, etc.) applied in the mounting hole area that would decrease the retention of the housing in the panel.
5. If the two items above are not complied with, the "A" dimension should be reduced .020 [5.08] for proper retention.

3 and 4 Circuit, In-Line



6, 9, 12 and 15 Circuit, Matrix



| Number of Circuits | Dimensions | | | Part Numbers | |
|--------------------|--------------|----------------|----------------|--|--|
| | E | F | G | Pin Housing (Cap) | Socket Housing (Plug) |
| 3 | .325 8.26 | .810 20.57 | .630 16.00 | 1-480305-0 ² | 1-480304-0 |
| 4 | .330 8.38 | 1.010 25.65 | .825 20.96 | 1-480426-0 ^{2,4} 3-480426-0 ^{1,2,4} | 1-480425-0 ⁴ 3-480425-0 ^{1,4} |
| 6 | — | .665 16.89 | .555 14.10 | 1-480276-0 ³ | 1-480273-0 |
| 9 | — | .905 22.99 | .795 20.19 | 1-480277-0 ³ | 1-480274-0 |
| 12 | — | 1.145 29.08 | 1.045 26.54 | 1-480278-0 ³ | 1-480275-0 |
| 15 | — | 1.382 35.10 | 1.280 32.51 | 1-480324-0 ³ | 1-480323-0 |

¹Housing material has 125°C temperature rating
²Detent lock
³Positive lock
⁴Used by disk drive industry

Note: All part numbers are RoHS Compliant.

3 and 4 Circuit, In-Line



6, 9, 12 and 15 Circuit, Matrix



| Number Circuits | Dimensions | |
|-----------------|----------------|----------------------------|
| | A | B |
| 3 | .890 22.61 | .645-.635 16.38-16.13 |
| 4 | 1.100 27.94 | .845-.835 21.46-21.21 |
| 6 | .840 21.34 | .575-.570 14.61-14.48 |
| 9 | 1.075 27.31 | .815-.810 20.70-20.57 |
| 12 | 1.320 33.53 | 1.055-1.050 26.80-26.67 |
| 15 | 1.550 39.37 | 1.290-1.285 32.77-32.64 |

Note: Dimensions "C" and "D" are to be equal.

Commercial MATE-N-LOK Connectors (Continued)

Motor Mount, Positive Lock 6, 8, 10, 12 and 16 Circuit, Dual Row



| Number of Circuits | Dimensions | | Part Numbers | |
|------------------------------|----------------|----------------|-------------------|-------------------------|
| | E | F | Pin Housing (Cap) | Socket Housing (Plug) |
| UL94V-2 Nylon, Natural Color | | | | |
| 6 | .705 17.90 | .610 15.49 | 1-480271-0 | 1-480270-0 ¹ |
| 8 | .900 22.86 | .805 20.45 | 1-480284-0 | 1-480283-0 ¹ |
| 10 | 1.095 27.81 | 1.000 25.4 | 1-480286-0 | 1-480285-0 ¹ |
| 12 | 1.290 32.77 | 1.195 30.35 | 1-480288-0 | 1-480287-0 |
| 16 | 1.680 42.67 | 1.585 40.26 | 1-480439-0 | 1-480438-0 |

¹Housing accepts double wire applications where individual insulation diameters do not exceed .115 [2.92].

Note: All part numbers are RoHS Compliant.

Standard Density

Recommended Panel Cutout for Motor Mount Pin Housing

View is from pin housing entry side.



Note: Motor mount housings may be used in flat panels

| Number of Circuits | A Dim. |
|--------------------|----------------|
| 6 | .715 18.16 |
| 8 | .910 23.11 |
| 10 | 1.105 28.07 |
| 12 | 1.300 33.02 |
| 16 | 1.690 42.93 |

Mounting Information

1. Recommended panel thickness "E" is .040-.100 [1.02-2.54] and is dependent on "T" and "R".
2. The pin housing must be inserted in a rocking manner.
3. The panel must be punched so that the housing enters the panel in the same direction as the punch.

Commercial MATE-N-LOK Connectors
.200 [5.08] Centerline

Commercial MATE-N-LOK Connectors (Continued)

PC Board Vertical Pin Headers

Material

Housing — Nylon, natural color
Flammability Rating — UL94V-2
Contacts — Phosphor bronze
 Solder tail diameter .062 [1.57]

Related Product Data

Product Specifications
 108-1077 Commercial MATE-N-LOK
 PC Board Headers

Performance Characteristics —
 pages 151-152
Technical Documents — pages 151
 and 205-206
Mating Socket Housings —
 pages 157-160
Mating Socket Headers — page 162
Mating IDC — page 163

**2, 3, and 4 Circuit,
In-Line**



**6, 8, 10, 12 and 16 Circuit,
Dual Row**



| Number of Circuits | A Dim. | Type Lock | Finish | Part Numbers | | Mates with Socket Housing Part Number |
|---------------------|------------------------|------------------------|------------------------------|----------------------------|------------------------|---------------------------------------|
| | | | | Standard ² Tail | Long ³ Tail | |
| 2 | .515 13.09 | Positive | Pre-tin | 350539-1 | 350540-1 | 1-480720-0 |
| | | | Duplex ¹ | 1586530-2 | — | |
| | | Detent | Pre-tin | 350209-1 | 350422-1 | 1-480318-0 |
| | | | Duplex ¹ | 1586512-2 | — | |
| 3 | .715 18.17 | Positive | Pre-tin | 350541-1 | 350542-1 | 1-480721-0 |
| | | | Duplex ¹ | 1586532-2 | — | |
| | | Detent | Pre-tin | 350210-1 | 350423-1 | 1-480303-0 |
| | | | Duplex ¹ | 1586514-2 | — | |
| 4 | .915 23.24 | Positive | Pre-tin | 350543-1 ⁵ | 350544-1 ⁵ | 1-480722-0 ⁵ |
| | | | Duplex ¹ | 1586534-2 ⁵ | 1586536-2 ⁵ | |
| | | Detent | Pre-tin | 350211-1 ⁵ | 350424-1 ⁵ | 1-480424-0 ^{4,5} |
| | | | 794236-1 ^{5,8} | — | | |
| | | | Post-tin | 1586627-1 ^{5,6} | — | |
| | | | 1-1586627-1 ^{5,6,7} | — | | |
| Duplex ¹ | 1586515-2 ⁵ | 1586525-2 ⁵ | — | | | |
| 6 | .705 17.91 | Positive | Pre-tin | 1-380999-0 | 350425-1 | 1-480270-0 |
| | | | Duplex ¹ | 2-1586546-0 | 1586526-2 | |
| 8 | .900 22.86 | Positive | Pre-tin | 350212-1 | 350426-1 | 1-480283-0 |
| | | | Duplex ¹ | 1586518-2 | 1586528-2 | |
| 10 | 1.095 27.81 | Positive | Pre-tin | 1-380991-0 | 350219-1 | 1-480285-0 |
| | | | Duplex ¹ | 2-1586544-0 | — | |
| 12 | 1.290 32.77 | Positive | Pre-tin | 350213-1 | 350220-1 | 1-480287-0 |
| | | | Duplex ¹ | 1586520-2 | 1586524-2 | |
| 16 | 1.680 42.68 | Positive | Pre-tin | 350214-1 | 350427-1 | 1-480438-0 |
| | | | Duplex ¹ | 1586522-2 | 1586529-2 | |

¹Duplex Finish — Plated with .000030 [.000762] min. gold in mating area, matte tin on solder tail end over .000050 [.00127] min. nickel underplate on entire contact.
²Use standard tail for .062 [1.57] thick PC Board.
³Use long tail for .125 [3.18] thick PC Board.
⁴Other mating connectors include a vertical PC Board socket header and the insulation displacement connectors (IDC).
⁵Used by the disk drive industry.
⁶With drain holes.
⁷Tube loaded.
⁸Housing material UL94V-0 rated.

Note: All part numbers are RoHS Compliant.

Commercial MATE-N-LOK Connectors (Continued)

**PC Board Surface Mount
Right-Angle Pin Header**

Material and Finish

Housing—Nylon, black color

Flammability Rating—UL94V-2

Contact—Phosphor bronze, pre-tin
Solder tail width .052 [1.32]

4 Circuit, In-Line



Part Number
770829-1

Notes:

1. Mating parts include socket housings, a vertical PC Board socket header below and the insulation displacement connectors (IDC).
2. Used by the disk drive industry.

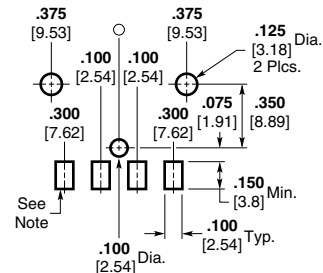

Note: .010 [.25] min. thick solder paste, 63/27 tin

Recommended PC Board Layout
.062 [1.57] thick PC Board

**PC Board Vertical
Socket Headers**

Material

Housing—Nylon, natural color

Flammability Rating—UL94V-2

Contacts—Phosphor bronze
Solder tail diameter .062 [1.57]

4 Circuit, In-Line

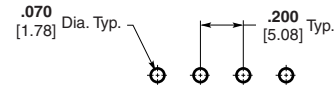

Recommended PC Board Hole Layout
.062 [1.57] thick PC Board

**6, 9, 12 and 15 Circuit,
Matrix**



Recommended PC Board Hole Layout
.062 [1.57] thick PC Board

Related Product Data

Product Specifications

108-1077 Commercial MATE-N-LOK
PC Board Headers

Performance Characteristics—
pages 151-152

Technical Documents—pages 151
and 205-206

Mating Pin Housings—pages 157-160

Mating Pin Headers—pages 161-164

Mating Socket Housings—
pages 157-160

Mating Socket Headers—page 162

Mating IDC—page 163

| Number of Circuits | A Dim. | Finish | Part Numbers | | Mates with Pin Housing Part Number |
|--------------------|----------------|---------------------|----------------------------|------------------------|------------------------------------|
| | | | Standard Tail ⁵ | Long Tail ⁶ | |
| 4 | 1.000 25.40 | Pre-tin | 770997-1 ³ | — | 1-480426-02, ³ |
| | | | 794285-13, ⁷ | — | |
| | | | 794287-13,4, ⁸ | — | |
| 6 | .720 18.29 | Pre-tin | 350641-1 | 350576-1 | 1-480276-0 |
| | | Duplex ¹ | 1586539-2 | — | |
| 9 | .960 24.39 | Pre-tin | 350642-1 | 350577-1 | 1-480277-0 |
| 12 | 1.200 30.49 | Pre-tin | 350643-1 | 350578-1 | 1-480278-0 |
| 15 | 1.440 36.58 | Pre-tin | 350644-1 | 350579-1 | 1-480324-0 |

¹Duplex Finish—Plated with .000030 [.000762] min. gold in mating area, matte tin on solder tail end over .000050 [.00127] min. nickel underplate on entire contact.

²Other mating connectors include vertical, right-angle and surface mount PC Board pin headers.

³Used by the disk drive industry.

⁴Surface mount compatible.

⁵Use standard tail for .062 [1.57] thick PC Board.

⁶Use long tail for .125 [3.18] thick PC Board.

⁷Low Mating Force

⁸High Temperature

Note: All part numbers are RoHS Compliant.

Standard Density

Commercial MATE-N-LOK Connectors
.200 [5.08] Centerline

Commercial MATE-N-LOK Connectors (Continued)

PC Board Right-Angle Pin Headers

Material and Finish

Contact—Phosphor bronze, pre-tin
Solder tail width .052 [1.32]

2, 3, and 4 Circuit, In-Line

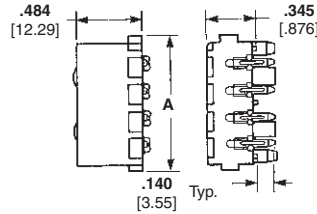

2, 3, and 4 Circuit

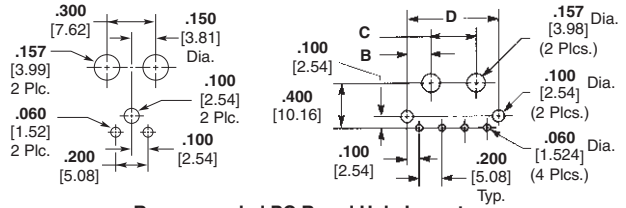

Recommended PC Board Hole Layout
.062 [1.57] thick PC Board

| Number of Circuits | Dimensions | | | | Housing Material | Part Numbers | Mates with Socket Housing Part Number |
|--------------------|----------------|--------------|---------------|---------------|---------------------------------|--|---------------------------------------|
| | A | B | C | D | | | |
| 2 | .600 15.24 | — | .300 7.62 | — | UL94V-2 Nylon Natural Color | 794120-1 | 1-480318-0 |
| 3 | .800 20.32 | .150 3.81 | .300 7.62 | .600 15.24 | UL94V-0 Nylon | 643488-1 | 1-480303-0 |
| 4 | 1.000 25.40 | .200 5.08 | .400 10.16 | .800 20.32 | UL94V-2 Nylon, Natural Color | 641737-1 ³ 770846-11, ³ | 1-480424-02, ³ |
| | | | | | UL94V-0 Nylon | 1-641737-1 ³ | 770827-12, ³ |

¹Surface Mount Compatible. ²Other mating connectors include a vertical PC Board socket header and the insulation displacement connectors (IDC). ³Used by the disk drive industry.

Dust Covers

Material

Housing—Polyester, white color
Flammability Rating—UL94V-2



For Feed-To Wiring
Part Number 770232-1

For Feed-Through Wiring
Part Number 770233-1

Note: These parts are used with the insulation displacement connectors below.

Insulation Displacement Connectors (IDC)

Material

Housing—Nylon
Contact—Phosphor bronze

Related Product Data

Used by the disk drive industry.

Product Specifications

108-1077 Commercial MATE-N-LOK
PC Board Headers

108-49000 IDC Connectors

Application Specification

114-49001 IDC Connectors

Performance Characteristics—
pages 151-152

Technical Documents—
pages 151 and 205-206

Mating Socket Housings—
pages 157-160

Mating Pin Housings—pages 157-
160

Mating Pin Headers—pages 161-164

4 Circuit, In-Line

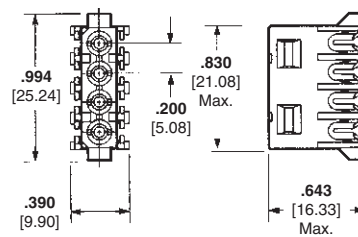

Socket Assembly (Plug)

| Wire Size Range AWG [mm ²] | Color Code | Finish | Part Number | | Mates with Part Numbers |
|---|---------------|---------|-------------|----------|--|
| | | | UL94V-2 | UL94V-0 | |
| 22 [.3] | Red | Pre-tin | 770156-2 | 794036-3 | 1-480426-0** 350211-1 350211-2 350424-1 350424-2 641737-1 |
| 20 [.5] | Yellow | Pre-tin | 770156-4 | 794036-2 | 1-641737-1 770827-1 770829-1 770846-1 |
| 18 [.8] | Orange | Pre-tin | 770156-3 | 794036-1 | |
| 16 [1.2] | Blue | Pre-tin | 770156-5* | 794036-4 | |

*Application Tooling: Arbor Tool 91085-2 uses head 231920-2. **Pin Housing

Notes:

1. Insulation diameter .095 [2.41] max.

2. Application Tooling

Power Unit No. **91112-2** (IS 408-7763) uses Head No. **231920-2** (IS 408-9330) and Hand Tool Handle No. **58074-1** (IS 408-6790) uses Terminating Head No. **231894-1** (IS 408-3186)

Note: All part numbers are RoHS Compliant.

Commercial MATE-N-LOK Connectors (Continued)

PC Board Right-Angle Pin Header with Fix Belt

Material

Housing — Thermoplastic
Flammability Rating — UL94V-2
Contacts — Copper Alloy

Related Product Data

Used by the disk drive industry

Product Specification

108-5155

4 Circuit, In-Line



Part No. 174552-1

Notes: Mates with socket housing Part No. 1-480424-0. Other mating connectors include a vertical PC Board socket header and the insulation displacement connectors (IDC).



Recommended PC Board Hole Layout
.062 [1.57] thick PC Board

PC Board Right-Angle Pin Headers with Fix Belt Reverse Polarization

Material and Finish

Housing — Nylon
Flammability Rating — UL94V-2
Contacts — Tin plated, Copper alloy

Related Product Data

Used by the disk drive industry

Product Specification

108-5155

4 Circuit, In-Line



Part No. 174804*

Recommended PC Board Hole Layout
.062 [1.57] thick PC Board

Notes: Mates with socket housing Part No. 1-480424-0. Other mating connectors include a vertical PC Board socket header and the insulation displacement connectors (IDC).

Note: All part numbers are RoHS Compliant.

| Part No. | A Dim.* | Description |
|----------|--------------|----------------------|
| 174804-1 | .150 3.80 | Long Clamp with Kink |

Standard Density

Commercial MATE-N-LOK Connectors
.200 [5.08] Centerline

.140 MATE-N-LOK Connectors (Large Insulation), .240 Centerline

Product Facts

- Available in 2, 3 and 9 circuit configurations for panel mounting; 4 and 9 circuit configurations for free-hanging applications
- Standard natural nylon housings
- Housings fully polarized
- Contacts fully protected in housings
- Contacts accept wire size range 20-10 AWG [1.5-5.0 mm²] with insulation diameters from .100 [2.54] to .180 [4.57]
- Low insertion/extraction forces
- Dual locking lances provide optimum contact stability
- Extraction tool removes both pins and sockets
- Contacts are on .240 [6.09] centerline spacing
- Not for interrupting current
- Recognized under the Component Program of Underwriters Laboratories Inc., File No. E28476
- Certified by Canadian Standards Association, File No. LR 7189A



Maximum Current—Maximum current rating of .140 MATE-N-LOK Connectors is limited by the maximum operating temperature of the housings which is 105°C and the temperature rise of the contacts which is 30°C. There are several variables which have a direct effect on this maximum current-carrying capability for a given connector and must be considered for each application. These variables are:

Wire Size—Larger diameter wire will carry more current since it has less internal resistance to current flow and thus generates less heat. Longer wire lengths also enhance current-carrying capabilities since the wire conducts heat away from the connector.

Connector Size—In general, the more circuits in a connector, the less current can be carried.

Ambient Temperature—The higher the ambient temperature, the less current can be carried in any given connector.

Technical Documents

Product Specification
108-1032 .140 Diameter
MATE-N-LOK Connectors

Application Specification
114-1007 .140 Diameter
MATE-N-LOK Contacts

Performance Characteristics

The .140 MATE-N-LOK Connector performance characteristics found on this page are based on free-hanging and panel mount connectors, loaded with contacts crimped on stranded wire.

Dielectric Withstand Voltage—3.0 KVAC between adjacent circuits

Insulation Resistance—1000 megohms minimum initial between adjacent circuits

Voltage Rating—600 V AC or DC

Connector Mating—4.5 lb. max. per circuit

Connector Unmating—8 lb. min. per circuit

Contact Retention—30 lb. min.

Durability—25 cycles, mating and unmating

Thermal Shock—-55°C to +85°C

Temperature-Humidity Cycling—25°C to 65°C at 95 RH

| Wire Size | | Termination Resistance | | Contact Crimp Tensile Force | |
|-----------|-----------------|------------------------|-----------------------------------|-----------------------------|-----|
| AWG | mm ² | Test Current (Amps) | Resistance Milliohms (Max. Init.) | Force (Min.) | |
| | | | | lbs. | N |
| 20 | .5 | 4.5 | 3.0 | 20 | 89 |
| 18 | .8 | 6 | 2.5 | 30 | 133 |
| 16 | 1.2 | 8 | 2.5 | 45 | 200 |
| 14 | 2.0 | 10 | 2.0 | 50 | 222 |
| 12 | 3.0 | 12 | 1.5 | 60 | 267 |
| 10 | 5.0 | 14 | 1.5 | 65 | 289 |

Note: This is the total resistance between wire crimps of a mated pin and socket.

Current Rating Verification for 30°C Maximum Temperature Rise 100% Energized

Wire-to-Wire

.140 MATE-N-LOK Connector Calculated Current Table

| Number of Circuits | Wire AWG | | | | | |
|--------------------|----------|-------|-------|-------|-------|-------|
| | 10 | 12 | 14 | 16 | 18 | 20 |
| 2 | 28.00 | 23.00 | 18.50 | 15.00 | 13.50 | 10.50 |
| 3 | 25.00 | 21.00 | 17.00 | 13.50 | 12.00 | 9.50 |
| 9 | 18.50 | 15.00 | 12.00 | 10.00 | 9.00 | 7.00 |

Values are based on initial Temperature Rise versus Current Testing and are intended to be a guide in the selection of a connector family. All applications should be tested by the end user. The values listed are per circuit for fully loaded housings being 100% energized. **Note:** All combinations were not tested, and this chart contains interpolated and extrapolated values.

Minimum Wire Lengths for T-Rise vs. Current Testing

Note: If wire lengths used are less than those listed, the current carrying ability of the system will be reduced due to less heat being conducted away from the connector. The customer should fully test all applications.

.140 MATE-N-LOK Connectors (Large Insulation), .240 Centerline (Continued)

Contacts

Pin diameter .140 [3.57]
Stock thickness .014 [.357]

Related Product Data

Product Specification
108-1032 .140 Diameter
MATE-N-LOK Connectors

Application Specification
114-1007 .140 Diameter
MATE-N-LOK Contacts

Performance Characteristics—
page 159

Keying Plug—none

Housings—pages 166-167

Technical Documents—pages 165
and 205-206

Application Tooling—pages 207-210



| Wire Size Range AWG [mm ²] | Ins. Dia. Range | Material & Finish | Contact Part Numbers | | | | HDM Applicator Part No. | Hand Tool Part No. |
|---|-----------------------|---------------------|----------------------|-------------|------------|-------------|----------------------------------|----------------------|
| | | | Pin | | Socket | | | |
| | | | Strip Form | Loose Piece | Strip Form | Loose Piece | | |
| 20-14 [.5-2.0] | .100-.180 2.54-4.5 | Brass, pre-tin | 61627-1 | 350389-1 | 61626-1 | 350388-1 | 567306-1 567306-2 567306-3 | 90247-1 |
| | | Phos. Brz., pre-tin | 61627-2 | — | 61626-2 | — | | |
| 14-10 [2.0-5.0] | .100-.180 2.54-4.5 | Brass, pre-tin | 350201-1 | 350391-1 | 350200-1 | 350390-1 | 567309-1 567309-2 567309-3 | 69710-1 ² |
| | | Phos. Brz., pre-tin | 350201-2 | 350391-2 | 350200-2 | 350390-2 | | |

¹HDM Applicator part number ending in -1 is used on AMPOMATOR CLS Machine with T or G Terminators, -2 is used on AMP-O-LECTRIC Model K Machine, -3 is used on AMP-O-LECTRIC Model G Machine. See pages 207-210 for further information.

²Hand Tool No. **69710-1** uses die set No. **58374-1** for 14-12 AWG and No. **58373-1** for 10 AWG.



Contact Extraction Tool
Part No. 318845-1
IS 408-4378

Housings

Free-Hanging

.240 [6.09] Centerline spacing

Material

Nylon, natural color

Flammability Rating—UL94V-2

Cavity Identification
(Rear View)



Cap



Plug

4 Circuit



Pin Housing (Cap)
Part No. 1-480512-0
Part No. 794700-1 (Black Color High Temp.)



Socket Housing (Plug)
Part No. 1-480510-0

9 Circuit, Matrix



Pin Housing (Cap)
Part No. 1-480586-0

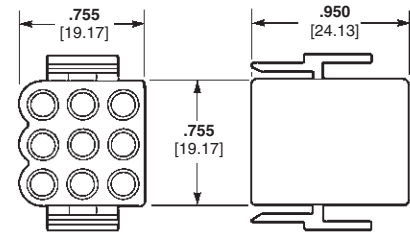

Socket Housing (Plug)
Part No. 1-480585-0

Note: All part numbers are RoHS Compliant.

.140 MATE-N-LOK Connectors (Large Insulation) .240 [6.10] Centerline Standard Density

.140 MATE-N-LOK Connectors (Large Insulation), .240 Centerline (Continued)

Housings

Panel Mount

.240 [6.09] Centerline spacing

Material

Housing—Nylon, natural color

Flammability Rating—UL94V-2

Cavity Identification
(Rear View)



Related Product Data

Product Specification

108-1032 .140 Diameter
MATE-N-LOK Connectors

Application Specification

114-1007 .140 Diameter
MATE-N-LOK Contacts

Performance Characteristics—
page 165

Keying Plug—none

Contacts—page 166

Technical Documents—pages 165
and 205-206

2 and 3 Circuit, In-Line



Socket Housing (Plug)
Part No. 1-350344-0
Part No. 794699-1 (Black Color High Temp.)



Pin Housing (Cap)
Part No. 1-350345-0
Part No. 1586305-1 (Black Color High Temp.)

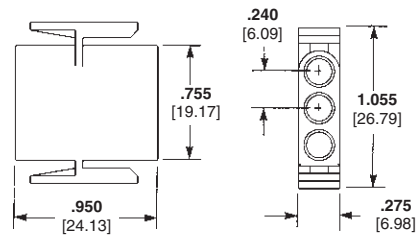

Socket Housing (Plug)
Part No. 1-350346-0

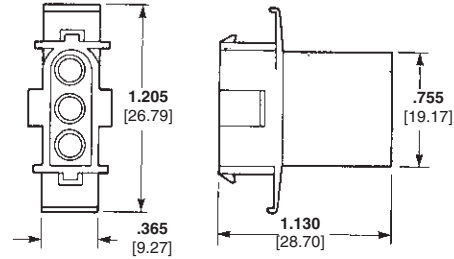

Pin Housing (Cap)
Part No. 1-350347-0
Part No. 794061-1 (Black Color High Temp.)

9 Circuit, Matrix



Socket Housing (Plug)
Part No. 1-480672-0
Part No. 1586305-1 (Black Color High Temp.)

Pin Housing (Cap)
Part No. 1-480673-0
Part No. 794683-1 (Black Color High Temp.)

Recommended Panel Cutouts

View is from housing entry side

2 and 3 Circuit

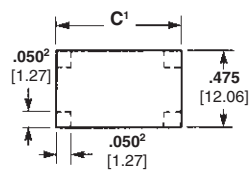

12 Circuit-.725 [18.42]
3 Circuit-.965 [24.51]
.2050 x .050 [1.27-1.27] tabs in corners of outlet are optional to reduce housing float in panel.

9 Circuit

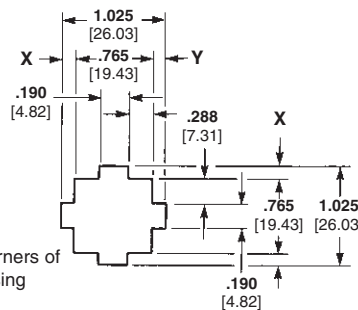

Notes:

1. Panel thickness .040-.070 [1.02-1.78].
2. "X" and "Y" dimensions must be within .005 [0.127] of each other.
3. Panel should be punched so that the housing enters the panel in the same direction as the punch for ease of assembly.



Note: All part numbers are RoHS Compliant.

Engineering Notes



Universal MATE-N-LOK Connectors

Product Facts

- Pins and sockets can be intermixed in the same housing
- Positive polarization
- Rear cavity identification
- Contacts completely enclosed in housings
- Positive locking housings
- Insulation capability to .200 [5.08] diameter
- Removable, crimp snap-in contacts
- Low contact mating force
- Contacts accept 30-10 AWG [.05-5.0 mm²] wire sizes
- Contacts available with pre-tin or gold plating
- Dual locking lances provide optimum contact stability
- Panel mount or free-hanging
- Mate with Universal MATE-N-LOK II Housings
- Available in UL 94V-0 flame retardant material. Meets the material requirements of table 25.1 of U.L. Standard 1410 (television receivers and video products)
- Not for interrupting current
- Harness to PC Board capability using pin or socket headers
- Pin and socket headers are available in both vertical and right-angle style
- Solderability—headers meet MIL-STD 202 Method 208
- Contacts are on .250 [6.35] centerline spacing
- Recognized under the Component Program of Underwriters Laboratories Inc., File No. E28476 
- Certified by Canadian Standards Association, File No. LR 7189 
- Passed test by VDE under their Registration Number 3980/Continuous Surveillance 



Performance Characteristics

The Universal MATE-N-LOK Connector performance characteristics found on pages 169-170 are based on free-hanging and panel mount connectors, loaded with contacts crimped on stranded wire.

Dielectric Withstanding Voltage—5.0 KVAC or 5.0 KVDC between adjacent circuits

Insulation Resistance—1000 megohms minimum initial between adjacent circuits

Voltage Rating—600 V AC or DC

Contact Insertion Force—5.0 lb. max. per contact

Contact Retention—15 lb. min. per contact

Durability—50 cycles, mating and unmating

Technical Documents

Product Specifications

108-1031 Universal MATE-N-LOK Connectors

108-1053 Universal MATE-N-LOK PC Board Headers

Application Specification

114-1010 Universal MATE-N-LOK Contacts

Instruction Sheet

408-7714 Plug, Cap, Headers, Pin, Socket and Accessories

Universal MATE-N-LOK Connectors (Continued)

Performance Characteristics (Continued)

Maximum Current—Maximum current rating of Universal MATE-N-LOK connectors is limited by the maximum operating temperature of the housings which is 125°C for 94V-2 housings and 120°C for 94V-0 housings including the temperature rise of the contacts which is a maximum of 30°C. There are several variables which have a direct effect on this maximum current-carrying capability for a given connector and must be considered for each application. These variables are:

Wire Size—Larger diameter wire will carry more current since it has less internal resistance to current flow and thus generates less heat. Longer wire lengths also enhance current carrying capabilities since the wire conducts heat away from the connector.

Connector Size—In general, the more circuits in a connector, the less current can be carried.

Ambient Temperature—The higher the ambient temperature, the less current can be carried in any given connector.

Printed Wiring Board Conductor Size—The finished trace conductor width and thickness should be maximized to allow for the greatest current carrying capacity and heat dissipation.

Universal MATE-N-LOK connectors also will withstand the following tests:

Vibration—10-55-10 cycles per minute at .06 inch total excursion

Physical Shock—18 drops, 50 G sawtooth at 10 milliseconds

Housing Panel Retention—75 lb. min.

Housing Lock Strength—30 lb. min.

Thermal Shock—-55°C to +85°C

Temperature-Humidity Cycling—25°C to 65°C at 95 RH

Corrosion—48 hr. at 5% salt concentration

Related Product Data

Product Specifications

108-1031 Universal MATE-N-LOK Connectors

108-1053 Universal MATE-N-LOK Headers

Current Rating Verification for 30°C Maximum Temperature Rise 100% Energized

Wire-to-Wire

Calculated Current Table

| Number of Circuits | Wire Gauge | | | | | | | | | |
|--------------------|------------|-------|-------|-------|-------|-------|------|------|------|------|
| | 10 | 12 | 14 | 16 | 18 | 20 | 22 | 24 | 26 | 30 |
| 2 | 19.00 | 18.00 | 17.00 | 14.50 | 13.00 | 10.00 | 8.00 | 6.50 | 5.50 | 3.50 |
| 3 | 17.50 | 16.50 | 15.50 | 13.00 | 12.00 | 9.00 | 7.50 | 6.00 | 5.00 | 3.00 |
| 4 | 16.50 | 15.50 | 15.00 | 12.50 | 11.00 | 8.50 | 7.00 | 5.50 | 4.50 | 3.00 |
| 5 | 16.00 | 15.00 | 14.00 | 12.00 | 10.50 | 8.00 | 6.50 | 5.50 | 4.50 | 3.00 |
| 6 In-Line | 15.50 | 14.50 | 13.50 | 11.50 | 10.00 | 8.00 | 6.50 | 5.00 | 4.00 | 2.50 |
| 6 Matrix | 15.00 | 14.00 | 13.00 | 11.00 | 9.50 | 7.50 | 6.00 | 5.00 | 4.00 | 2.50 |
| 8 | 14.50 | 14.00 | 13.00 | 10.50 | 9.50 | 7.50 | 6.00 | 5.00 | 4.00 | 2.50 |
| 9 | 13.50 | 12.50 | 11.50 | 9.50 | 8.50 | 6.50 | 5.50 | 4.50 | 3.50 | 2.00 |
| 10 | 14.00 | 13.00 | 12.50 | 10.00 | 9.00 | 7.00 | 5.50 | 4.50 | 3.50 | 2.50 |
| 12 | 12.50 | 12.00 | 11.00 | 9.00 | 8.00 | 6.00 | 5.00 | 4.00 | 3.00 | 2.00 |
| 15 | 12.00 | 11.50 | 10.00 | 8.50 | 7.50 | 6.00 | 4.50 | 4.00 | 3.00 | 2.00 |

Values are based on initial Temperature Rise versus Current Testing and are intended to be a guide in the selection of a connector family. All applications should be tested by the end user. The values listed are per circuit for fully loaded housings being 100% energized. **Note:** All combinations were not tested, and this chart contains interpolated and extrapolated values.

Minimum Wire Lengths for T-Rise vs. Current Testing

| AWG | Min. Length (in.) | AWG | Min. Length (in.) |
|-----|-------------------|-----|-------------------|
| 30 | 2.6 | 18 | 9.4 |
| 28 | 3.2 | 16 | 11.3 |
| 26 | 4.1 | 14 | 13.7 |
| 24 | 5.1 | 12 | 16.4 |
| 20 | 7.8 | 10 | 19.3 |

Note: If wire lengths used are less than those listed above, the current carrying ability of the system will be reduced due to less heat being conducted away from the connector. The customer should fully test all applications.

Wire-to-Board

Due to the vast differences in trace geometry and printed circuit board configurations, we are unable to provide a separate current carrying chart for our printed circuit board header products. However, the above Wire-to-Wire charts may be used as a guideline for headers if the trace width and thickness is equal to the listed wire gauge. For vertical headers, only 95% of the Wire-to-Wire value should be used. For right-angle headers, only 75% of the Wire-to-Wire value should be used. The chart values are only a tool for connector selection and will require the customer to fully test their application.

Termination Resistance/Contact Crimp Tensile Force

| Wire Size | | Termination Resistance | | Contact Crimp Tensile Force | |
|-----------|-----------------|------------------------|-----------------------------------|-----------------------------|-----|
| AWG | mm ² | Test Current (Amps) | Resistance Milliohms (Max. Init.) | Force (Min.) lbs. | N |
| 30 | .05 | — | — | 2 | 9 |
| 28 | .08 | — | — | 3 | 13 |
| 26 | .12 | — | — | 6 | 27 |
| 24 | .2 | 1.5 | 3.50 | 8 | 36 |
| 22 | .3 | 3 | 3.50 | 14 | 62 |
| 20 | .5 | 4.5 | 3.00 | 14 | 62 |
| 18 | .8 | 6 | 3.00 | 30 | 133 |
| 16 | 1.2 | 8 | 2.75 | 45 | 200 |
| 14 | 2.0 | 10 | 2.75 | 50 | 222 |
| 12 | 3.0 | — | — | 60 | 267 |
| 10 | 5.0 | — | — | 70 | 311 |

Note: This is the total resistance between wire crimps of a mated pin and socket.

Universal MATE-N-LOK Connectors (Continued)

Universal MATE-N-LOK Connector Mating Combinations

| Connector Part Number ⁷ | | | | | Mating Connector Part Number | | | | | | | | | | |
|------------------------------------|----------------------|--|--|-------------------------------------|------------------------------|-------------------------------------|-------------------------|-----------|-------------------------------------|-------------------------|------------|--------------------------|----------|------------|----------|
| Number of Circuits | Flammability Rating | Style | Plug Part Number ² | Cap Part Number ² | Plating | Vertical Pin ² | | | Vertical Socket ² | | | Right-Angle ² | | | |
| | | | | | | Standard Tail | Standard Tail Polarized | Long Tail | Standard Tail | Standard Tail Polarized | Long Tail | Pin | Socket | | |
| 1 | | — | 1-350867-0 | 770421-1 | — | — | — | — | — | — | — | — | — | | |
| | | | UL94V-0 | 350865-1 | 350866-1 | — | — | — | — | — | — | — | — | — | |
| 2 | In-Line | — | 1-480698-0 794814-1 ³ | 1-480699-0 794815-1 ³ | Pre-tin | 350428-1 | 641963-1 | 350582-1 | 350759-4 | 643411-1 | 350986-4 | — | — | | |
| | | | | | Duplex ¹ | 350428-4 | 641963-3 | 350582-4 | 350759-5 | — | — | — | — | | |
| | | | UL94V-0 | In-Line | 350777-1 | 350778-1 | Pre-tin | 350786-1 | 641964-1 1-641964-1 ⁵ | 350787-1 | 350824-1 | 643412-1 | 350831-1 | 1-350942-0 | 643226-1 |
| | | | | | | | Duplex ¹ | 350786-3 | 641964-3 | 350787-3 | 350824-4 | 643412-3 | — | 3-350942-0 | — |
| UL94V-2 | In-Line ⁶ | 1-480700-0 794901-1 ³ | 1-480701-0 794900-1 ³ | Pre-tin | 350429-1 | 641965-1 | 350583-1 | 350760-4 | 643413-1 | 350987-4 | — | — | | | |
| | | | | Duplex ¹ | 350429-4 | — | 350583-4 | 350760-5 | — | — | — | — | | | |
| UL94V-0 | In-Line | 350766-1 | 350767-1 | Pre-tin | 350789-1 | 641966-1 1-641966-1 ⁴ | 350790-1 | 350825-1 | 643414-1 | 350832-1 | 1-350943-0 | 643228-1 | | | |
| | | | | Duplex ¹ | 350789-3 | — | 350790-3 | 350825-4 | 643414-3 | 350832-4 | 3-350943-0 | 3-643228-0 | | | |
| UL94V-2 | In-Line | 1-480702-0 794899-1 ³ | 1-480703-0 794707-1 ³ | Pre-tin | 350430-1 | 641967-1 | 350584-1 | 350761-4 | 643415-1 | 350988-4 | 1-350948-0 | — | | | |
| | | | | Duplex ¹ | 350430-4 | — | 350584-4 | 350761-5 | — | 350988-5 | — | — | | | |
| UL94V-0 | In-Line | 350779-1 | 350780-1 | Pre-tin | 350792-1 | 641968-1 | 350793-1 | 350826-1 | 643416-1 | 350833-1 | 1-350944-0 | 643230-1 | | | |
| | | | | Duplex ¹ | 350792-3 | — | 350793-3 | 350826-4 | — | 350833-4 | 3-350944-0 | 3-643230-0 | | | |
| UL94V-2 | In-Line | 1-480763-0 | 1-480764-0 ³ 794863-1 ³ | Pre-tin | 640466-1 | 643405-1 | — | 640467-1 | — | — | 1-350949-0 | — | | | |
| | | | | Duplex ¹ | 640466-3 | — | — | 640467-3 | — | — | — | — | | | |
| UL94V-0 | In-Line | 350809-1 | 350810-1 | Pre-tin | 640900-1 | 643406-1 | — | 640901-1 | — | — | 1-350945-0 | 643232-1 | | | |
| | | | | Duplex ¹ | 640900-3 | — | — | 640901-3 | — | — | 3-350945-0 | 3-643232-0 | | | |
| UL94V-2 | In-Line | 640585-1 | 926307-1 | Pre-tin | 641832-1 | 643407-1 | — | — | — | — | 640587-1 | — | | | |
| | | | | Duplex ¹ | 641832-3 | — | — | — | — | — | — | — | | | |
| UL94V-0 | In-Line | 640581-1 | 926307-3 | Pre-tin | 641831-1 | 643408-1 | — | 770262-1 | — | — | 640583-1 | 643234-1 | | | |
| | | | | Duplex ¹ | 641831-3 | — | — | 770262-3 | — | — | 640583-3 | 3-643234-0 | | | |
| UL94V-2 | Matrix ⁶ | 1-480704-0 794535-1 ³ 794096-1 ⁵ | 1-480705-0 794536-1 ³ | Pre-tin | 350431-1 | 641969-1 | 350585-1 | 350762-4 | 643423-1 | 350989-4 | — | — | | | |
| | | | | Duplex ¹ | 350431-4 | — | 350585-4 | 350762-5 | — | 350989-5 | — | — | | | |
| UL94V-0 | Matrix | 350715-1 | 350781-1 | Pre-tin | 350711-1 | 641970-1 | 350732-1 | 350827-1 | 643424-1 | 350834-1 | — | — | | | |
| | | | | Duplex ¹ | 350711-4 | 641970-3 | 350732-4 | 350827-4 | 643424-3 | 350834-4 | — | — | | | |
| UL94V-2 | In-Line | 640586-1 | 926308-1 | Pre-tin | 641825-1 | — | 770143-1 | — | — | — | — | — | | | |
| | | | | Duplex ¹ | — | — | — | — | — | — | — | — | | | |
| UL94V-0 | In-Line | 640582-1 | 926308-3 | Pre-tin | 641828-1 | 643410-1 | — | — | — | — | 640584-1 | 643236-1 | | | |
| | | | | Duplex ¹ | — | 643410-3 | — | — | — | — | 640584-3 | 3-643236-0 | | | |
| UL94V-2 | Matrix | 1-480706-0 794537-1 ³ | 1-480707-0 794538-1 ³ | Pre-tin | 350432-1 | 641971-1 | 350586-1 | 350763-4 | 643425-1 | 350990-4 | — | — | | | |
| | | | | Duplex ¹ | 350432-4 | 641971-3 | 350586-4 | 350763-5 | — | 350990-5 | — | — | | | |
| UL94V-0 | Matrix | 350720-1 | 350782-1 | Pre-tin | 350712-1 | 641972-1 1-641972-1 ⁴ | 350742-1 | 350828-1 | 643426-1 | 350835-1 | — | — | | | |
| | | | | Duplex ¹ | 350712-4 | 641972-3 | 350742-4 | 350828-4 | 643426-3 | 350835-4 | — | — | | | |
| UL94V-2 | In-Line | 926302-1 | 926309-1 | Pre-tin | — | — | — | — | — | — | — | — | | | |
| | | | | Duplex ¹ | — | — | — | — | — | — | — | — | | | |
| UL94V-0 | In-Line | 926302-3 | 926309-3 | Pre-tin | — | — | — | — | — | — | — | — | | | |
| | | | | Duplex ¹ | — | — | — | — | — | — | — | — | | | |
| UL94V-2 | Matrix | 1-480708-0 794851-1 ³ | 1-480709-0 794727-1 ³ | Pre-tin | 350433-1 | 641973-1 | 350587-1 | 350764-4 | — | 350991-4 | — | — | | | |
| | | | | Duplex ¹ | 350433-4 | — | 350587-4 | 350764-5 | — | 350991-5 | — | — | | | |
| UL94V-0 | Matrix | 350735-1 | 350783-1 | Pre-tin | 350713-1 | 641974-1 1-641974-1 ⁴ | 350737-1 | 350829-1 | 643428-1 | 350836-1 | — | — | | | |
| | | | | Duplex ¹ | 350713-4 | 641974-3 | 350737-4 | 350829-4 | — | 350836-4 | — | — | | | |
| UL94V-2 ⁶ | Matrix | 1-480710-0 794546-1 ³ | 1-480711-0 794545-1 ³ | Pre-tin | 350434-1 | 641975-1 | 350588-1 | 350765-4 | 643429-1 | 350992-4 | — | — | | | |
| | | | | Duplex ¹ | 350434-4 | — | 350588-4 | 350765-5 | — | — | — | — | | | |
| UL94V-0 | Matrix | 350736-1 | 350784-1 | Pre-tin | 350714-1 | 641976-1 | 350738-1 | 350830-1 | 643430-1 | 350837-1 | — | — | | | |
| | | | | Duplex ¹ | 350714-4 | 641976-4 | 350738-4 | 350830-4 | — | 350837-4 | — | — | | | |

¹Duplex Finish — Plated with .000030 [.000762] min. gold in mating area, matte tin on solder tail end over .000050 [.00127] min. nickel underplate on entire contact.

²Universal MATE-N-LOK Plug and Cap housings accept pin or socket contacts. Use the appropriate contacts in the Plug housing as required by the mating component.

³Housing material has 125°C temperature rating.

⁴Black in color.

⁵Tool Removable

⁶UV Resistant housing material available.

⁷European glow wire housing material available.

Note: All part numbers are RoHS Compliant.

Universal MATE-N-LOK Connectors (Continued)

Contacts

Solid pin diameter .084 [2.13]
Stock thickness .012 [.305] unless otherwise noted.
These contacts can be used in either Universal MATE-N-LOK Plug or Cap housings **only**.

Related Product Data

Product Specification
108-1031 Universal MATE-N-LOK Connectors
Application Specification
114-1010 Universal MATE-N-LOK Contacts

Performance Characteristics— pages 169-170
Technical Documents— pages 169 and 205-206
Application Tooling— pages 207-210
Housings— page 174



Solid Pin



Socket

| Wire Size Range AWG [mm ²] | Ins. Dia. Range | L Dim. | | Material & Finish | Contact Part Numbers | | | | HDM Applicator Part No. | Hand Tool Part No. |
|---|--------------------------------|---------------|---------------|--------------------------------------|----------------------|-------------|-----------------------------------|-----------------------|---|----------------------|
| | | Pin | Socket | | Pin | | Socket | | | |
| | | | | | Strip Form | Loose Piece | Strip Form | Loose Piece | | |
| 30-26 [.05-.12] | .032-.057 .813-1.45 | .790 20.06 | .760 19.30 | Brass, Pre-tin | 350924-1 | 770672-1 | 350925-1 | 770673-1 | 466616-2 ⁶ 466616-3 ⁶ | 58439-1 |
| | | | | Phos. Brz., Gold ² | 350924-6 | 770672-6 | 350925-6 | — | | |
| 24-18 [.2-.8] | .040-.100 1.02-2.54 | .790 20.06 | .760 19.30 | Brass, Pre-tin | 350561-1 | 350690-1 | 350851-1 350570-1 ¹ | 350689-1 ¹ | 466320-1 ⁶ 466320-2 ⁶ 466320-4 ⁶ | 91510-1 |
| | | | | Brass, Gold ² | 350561-2 | 350690-2 | 350851-2 | 640347-2 | | |
| | | | | Brass, Select Gold ³ | 350561-7 | 350690-7 | 350851-7 350570-7 ¹ | 350689-7 ¹ | | |
| | | | | Phos. Brz., Pre-tin | 350561-3 | 350690-3 | 350570-3 ¹ | 350689-3 ¹ | | |
| 20-14 [.5-2.0] | .060-.130 1.52-3.30 | .790 20.06 | .760 19.30 | Phos. Brz., Select Gold ³ | — | — | 350570-6 ¹ | — | 687763-1 ⁶ 687763-2 ⁶ 687763-6 ⁶ | 91500-1 |
| | | | | Brass, Pre-tin | 350218-1 | 350547-1 | 350536-1 | 350550-1 | | |
| | | | | Brass, Gold ² | 350218-2 | 350547-2 | 350536-2 | 350550-2 | | |
| | | | | Brass, Select Gold ³ | 350218-7 | 350547-7 | 350536-7 | 350550-7 | | |
| | | | | Phos. Brz., Pre-tin | 350218-3 | 350547-3 | 350536-3 | 350550-3 | | |
| 20-14 [.5-2.0] or 2 @ 18 [.8] | .130-.200 3.30-5.08 | .810 20.57 | .780 19.81 | Phos. Brz., Select Gold ³ | 350218-6 | 350547-6 | 350536-6 | 350550-6 | 687926-1 ⁶ 687926-2 ⁶ 687926-6 ⁶ | 91508-17 91506-17 |
| | | | | Brass, Pre-tin | 350538-1 | 350552-1 | 350537-1 | 350551-1 | | |
| | | | | Brass, Gold ² | 350538-2 | 350552-2 | 350537-2 | 350551-2 | | |
| | | | | Brass, Select Gold ³ | 350538-7 | 350552-7 | 350537-7 | 350551-7 | | |
| 18-14 ⁴ [.8-2.0] | .130-.200 3.30-5.08 | .810 20.57 | .780 19.81 | Phos. Brz., Pre-tin | 350538-3 | 350552-3 | 350537-3 | 350551-3 | 466588-1 ⁶ 466588-2 ⁶ 466588-3 ⁶ | 91508-17 91506-17 |
| | | | | Brass, Pre-tin | 350873-1 | — | 350874-1 | — | | |
| | | | | Phos. Brz., Pre-tin | 350873-3 | 350918-3 | 350874-3 | 350919-3 | | |
| 12-10 [3.0-5.0] | .200 max. ⁵ 5.08 | .810 20.57 | .780 19.81 | Phos. Brz., Pre-tin | 350922-3 | 640309-3 | 350923-3 | 640310-3 | 466597-1 ⁶ 466597-2 ⁶ | 69710-17 |
| | | | | Phos. Brz., Select Gold ³ | 350922-6 | 640309-6 | 350923-6 | 640310-6 | | |

¹Socket Contact — .010 [.254] stock thickness

²Gold Finish — Plated with .000030 [.000762] min. gold in mating area and inside wire barrel over .000050 [.00127] min. nickel underplate on entire contact.

³Select Gold Finish — Plated with .000030 [.000762] min. gold in mating area over .000050 [.00127] min. nickel underplate on entire contact.

⁴Recommended for predominant use of 14 AWG wire.

⁵There is no insulation barrel on this contact. Insulation maximum diameter is limited by the housing.

⁶HDM Applicator part number ending in -1 is used on AMPOMATOR CLS Machine with T or G Terminators, -2 is used on AMP-O-LECTRIC Model K Machine, -3, -4 & -6 are used on AMP-O-LECTRIC Model G Machine. See pages 207-210 for further information.

⁷Hand Tool No. **91508-1** is for wire size 20-18 AWG. Hand Tool No. **91506-1** is for wire size 16-14 AWG. Hand Tool No. **69710-1** use die set No. **58380-1** for 12 AWG and No. **58380-2** for 10 AWG.

Note: Phosphor bronze material contacts should be used in high temperature/humidity cycling applications.

Note: All part numbers are RoHS Compliant.



Contact Retention Test Tool
Part No. 1586701-1
IS 408-10003



Contact Extraction Tool
Part No. 318851-1
IS 408-4371



Contact Insertion Tool
(For inserting contacts applied to small diameter wire)
Part No. 91002-1
IS 408-7347

Universal MATE-N-LOK Connectors (Continued)

Contacts

Split pin diameter .086 [2.18]
Stock thickness .012 [.305]
These contacts can be used in either Universal MATE-N-LOK Plug or Cap housings **only**.

Related Product Data

Product Specification

108-1031 Universal MATE-N-LOK Connectors

Application Specification

114-1010 Universal MATE-N-LOK Contacts

Performance Characteristics—
pages 169-170

Technical Documents—pages 169
and 205-206

Application Tooling—pages 207-210
Housings—page 174

Split Pins



| Wire Size Range AWG [mm²] | Ins. Dia. Range | L Dim. | Material & Finish | Contact Part Number | | HDM Applicator Part No. | Hand Tool Part No. |
|--------------------------------------|------------------------|---------------|---------------------------------|---------------------|-------------|---|--|
| | | | | Strip Form | Loose Piece | | |
| 24-18 [.2-.8] | .040-.100 1.02-2.54 | .790 20.06 | Brass, Pre-tin | 350699-1 | 350706-1 | 466320-1 ³ 466320-2 ³ 466320-4 ³ | 91510-1 |
| | | | Brass, Gold ¹ | 350699-2 | 350706-2 | | |
| | | | Brass, Select Gold ² | 350699-7 | 350706-7 | | |
| 20-14 [.5-2.0] | .060-.130 1.52-3.30 | .790 20.06 | Brass, Pre-tin | 350687-1 | 350705-1 | 687763-1 ³ 687763-2 ³ 687763-6 ³ | 91500-1 |
| | | | Brass, Gold ¹ | 350687-2 | 350705-2 | | |
| | | | Brass, Select Gold ² | 350687-7 | 350705-7 | | |
| 20-14 [.5-2.0] or 2@18 [.8] | .130-.200 3.30-5.08 | .810 20.57 | Brass, Pre-tin | 350700-1 | 350707-1 | 687926-1 ³ 687926-2 ³ 687926-6 ³ | 91508-1 ⁴ 91506-1 ⁴ |
| | | | Brass, Gold ¹ | 350700-2 | 350707-2 | | |
| | | | Brass, Select Gold ² | 350700-7 | 350707-7 | | |

¹Gold Finish—Plated with .000030 [.000762] min. gold in mating area and inside wire barrel over .000050 [.00127] min. nickel underplate on entire contact.

²Select Gold Finish—Plated with .000030 [.000762] min. gold in mating area over .000050 [.00127] min. nickel underplate on entire contact.

³HDM Applicator part number ending in -1, is used on AMPOMATOR CLS Machine with T or G Terminators, -2 is used on AMP-O-LECTRIC Model K Machine, -4 & -6 are used on AMP-O-LECTRIC Model G Machine. See pages 207-210 for further information.

⁴Hand Tool No. **91508-1** for wire size 20-18 AWG. Hand Tool No. **91506-1** for wire size 16-14 AWG.

Notes:

1. Split pins recommended for use in housings having 6, 9, 12 and 15 circuits to reduce mating force.
2. Phosphor bronze material contacts are available for use in high temperature/humidity cycling applications, consult Tyco Electronics.

Grounding Pins

(.100 [2.54] longer than standard pin)
(Mate first, break last, not for interrupting current)



| Wire Size Range AWG [mm²] | Ins. Dia. Range | L Dim. | Material & Finish | Contact Part Number | | HDM Applicator Part No. | Hand Tool Part No. |
|------------------------------|--------------------------------|---------------|---------------------|---------------------|-------------|---|-----------------------|
| | | | | Strip Form | Loose Piece | | |
| 24-18 [.2-.8] | .060-.130 1.52-3.30 | .890 22.60 | Brass, Pre-tin | 770210-1 | — | 567216-2 ² 567216-3 ² | — |
| | | | | 350654-1 | 350669-1 | | |
| 20-14 [.5-2.0] | .060-.130 1.52-3.30 | .890 22.60 | Brass, Pre-tin | 350654-1 | 350669-1 | 687763-1 ² 687763-2 ² 687763-6 ² | 91500-1 |
| 12-10 [3.0-5.0] | .200 max. ¹ 5.08 | .910 23.11 | Phos. Brz., Pre-tin | 770234-3 | — | 466597-1 ² 466597-2 ² 466597-3 ² | — |
| | | | | — | — | | |

¹There is no insulation barrel on this contact. Insulation maximum diameter is limited by the housing.

²HDM Applicator part number ending in -1 is used on AMPOMATOR CLS Machine with T or G Terminators, -2 is used on AMP-O-LECTRIC Model K Machine, -3 & -6 are used on AMP-O-LECTRIC Model G Machine. See pages 207-210 for further information.

Programmable Connector Contact

(Socket with 110 Series Special FASTON Tab)

Material and Finish

Brass, pre-tin



Part Number
350877-1

Note: This contact will accept a 110 Series FASTON Receptacle—Part No. **350871-1** (strip form) allowing simple field wiring or wiring changes.

Note: All part numbers are RoHS Compliant.

Universal MATE-N-LOK Connectors (Continued)

Housings
Free-Hanging or Panel Mount
.250 [6.35] Centerline spacing

2, 3, 4, 5, 6, 8 and 10 Circuit, In-Line



1 Circuit, Free-Hanging

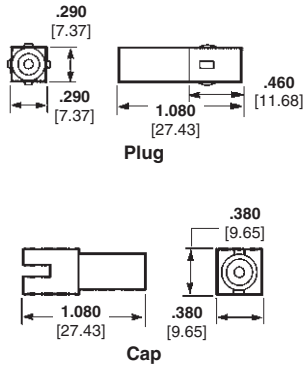

6 Circuit, Matrix

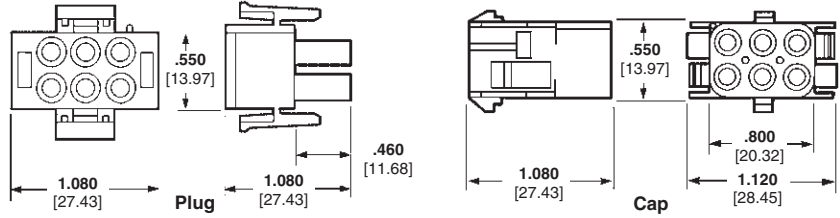

9, 12 and 15 Circuit, Matrix



Related Product Data

- Product Specification**
108-1031 Universal MATE-N-LOK Connectors
- Performance Characteristics**—
pages 169-170
- Contacts**—pages 172-173
- Panel Cutout**
- Recommendations**—page 175
- Keying Plug**—page 175
- Strain Reliefs**—pages 175-176
- Technical Documents**—pages 169 and 205-206
- Mating Headers**—pages 182-183 and 185
- Other Mating Connectors**
Universal MATE-N-LOK II Housings—
pages 193-194

Note: See charts on page 182 to order Plug and Cap Housings in colors.

| Number of Circuits | A Dim. | Housing Part Numbers | | | |
|--------------------|----------------|---|-------------------------|----------------------------|-----------------------|
| | | UL94V-2 Nylon, Natural Color ² | | UL94V-0 Nylon ³ | |
| | | Plug | Cap | Plug | Cap |
| 1 | — | 1-350867-0 | 770421-1 | 350865-1 | 350866-1 |
| 2 | .550 13.97 | 1-480698-0 ¹ | 1-480699-0 ¹ | 350777-1 ¹ | 350778-1 ¹ |
| 3 | .800 20.32 | 1-480700-0 ¹ | 1-480701-0 ¹ | 350766-1 ¹ | 350767-1 ¹ |
| 4 | 1.050 26.67 | 1-480702-0 ¹ | 1-480703-0 ¹ | 350779-1 ¹ | 350780-1 ¹ |
| 5 | 1.300 33.02 | 1-480763-0 ¹ | 1-480764-0 ¹ | 350809-1 ¹ | 350810-1 ¹ |
| 6 | 1.550 39.37 | 640585-1 ¹ | 926307-1 ¹ | 640581-1 ¹ | 926307-3 ¹ |
| | | 1-480704-0 794096-1 ⁴ | 1-480705-0 | 350715-1 | 350781-1 |
| 8 | 2.050 52.07 | 640586-1 ¹ | 926308-1 ¹ | 640582-1 ¹ | 926308-3 ¹ |
| 9 | .800 20.32 | 1-480706-0 | 1-480707-0 | 350720-1 | 350782-1 |
| 10 | 2.550 64.77 | 926302-1 ¹ | 926309-1 ¹ | 926302-3 ¹ | 926309-3 ¹ |
| 12 | 1.050 26.67 | 1-480708-0 | 1-480709-0 | 350735-1 | 350783-1 |
| 15 | 1.300 33.02 | 1-480710-0 | 1-480711-0 | 350736-1 | 350784-1 |

¹In-Line style.
²Housing material has 125°C temperature rating.
³Housing material has 120°C temperature rating.
⁴Tool Removable.

Note: All part numbers are RoHS Compliant.

Universal MATE-N-LOK Connectors
.250 [6.35] Centerline
Standard Density

Universal MATE-N-LOK Connectors (Continued)

Recommended Cap Housing Panel Cutouts

View is from cap entry side

Refer to Application Specification 114-1010



| Style | Number of Circuits | Dimensions | | | | | |
|---------|--------------------|----------------|----------------|---------------|----------------|----------------|--------------|
| | | A | B | C | D | E | |
| In-Line | 2 | .565 14.35 | .340 8.64 | .095 2.41 | .530 13.46 | .250 6.35 | |
| | 3 | .815 20.70 | .340 8.64 | .095 2.41 | .530 13.46 | .250 6.35 | |
| | 4 | 1.065 27.05 | .340 8.64 | .095 2.41 | .530 13.46 | .250 6.35 | |
| | 5 | 1.315 33.40 | .340 8.64 | .095 2.41 | .530 13.46 | .250 6.35 | |
| | 6 | 1.567 39.80 | .154 3.91 | .189 4.80 | .531 13.49 | .394 10.0 | |
| | 8 | 2.067 52.50 | .154 3.91 | .189 4.80 | .531 13.49 | .394 10.0 | |
| | 10 | 2.567 65.20 | .154 3.91 | .189 4.80 | .530 13.46 | .394 10.0 | |
| | Matrix | 6 | .565 14.35 | .480 12.19 | .275 6.99 | 1.030 26.16 | .250 6.35 |
| | | 9 | .815 20.70 | .480 12.19 | .275 6.99 | 1.030 26.16 | .250 6.35 |
| | | 12 | 1.065 27.05 | .480 12.19 | .275 6.99 | 1.030 26.16 | .350 8.89 |
| 15 | | 1.315 33.40 | .480 12.19 | .275 6.99 | 1.030 26.16 | .350 8.89 | |

Notes:

1. Recommended panel thickness — .030-.090 [.762-2.286]. Panel must be punched so that housing enters panel in same direction as the punch.
2. Optional — Do not remove this material when keying cap housing to panel.
3. Circuit #1 location when using panel keying with 6, 9, 12 and 15 circuit Matrix housings.
4. Circuit #1 location when using panel keying with 2, 3, 4, 5, 6, 8 and 10 circuit In-Line housings.
5. .175 [4.45] dimension is .125 [3.18] for 6, 8 and 10 circuit In-Line housings.

Keying Plugs

IS 408-3320



Part Numbers

UL94V-2 Nylon material, natural color — 1-640415-1
UL94V-0 Nylon material — 1-640415-0

Note: Keying plug snaps into plug or cap housing

Plug Housing Strain Reliefs

IS 408-3320

2, 3, 4, 5, 6 and 8 Circuit, In-Line



Part Numbers

UL94V-2 Nylon material, natural color — 1-350589-0
UL94V-0 Nylon material — 350811-1

6, 9, 12 and 15 Circuit, Matrix



Part Numbers

UL94V-2 Nylon material, natural color — 1-350590-0
UL94V-0 Nylon material — 350812-1

Note: Strain relief part number represents one half of a strain relief. Two strain reliefs required per housing.

Note: All part numbers are RoHS Compliant.

Universal MATE-N-LOK Connectors (Continued)

Plug or Cap Housing Strain Reliefs

IS 408-3320

Related Product Data

Housings—page 174
Technical Documents—pages 169 and 205-206

2, 3, 4, 5, 6, 8, 9, 12 and 15 Circuit (Enclosed)

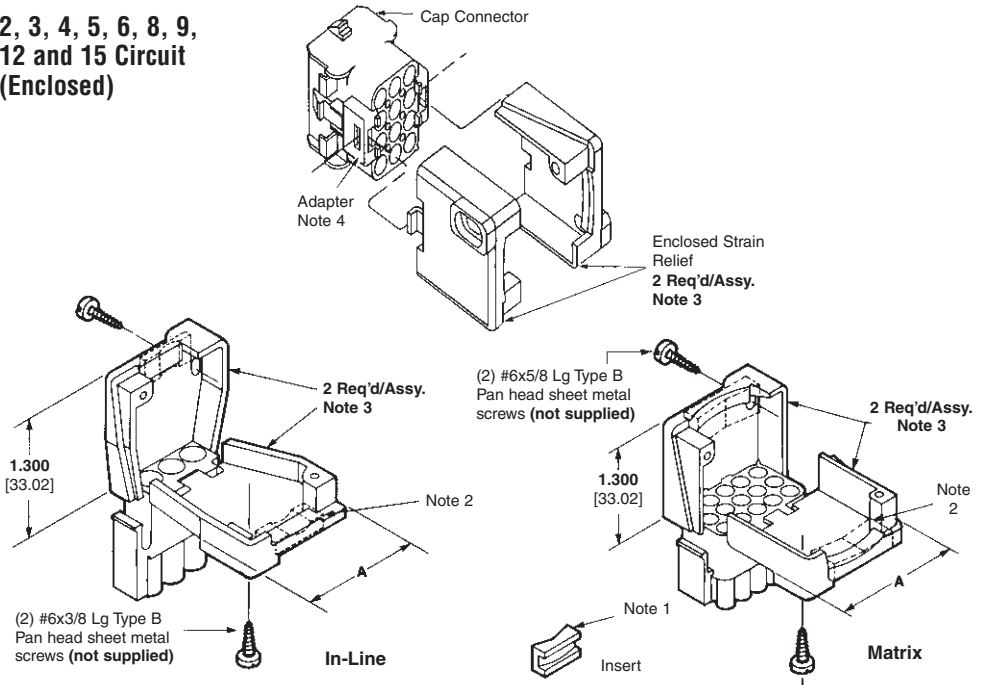

Cap Housing Adapters

These adapters are designed to anchor the cap housing strain reliefs to the housings and prevent the strain relief halves from "drawing in" when the screws are being torqued down to clamp the cable.

IS 408-3320

For All Positions Except 2, 6 and 8 Circuit Cap Housings



UL94V-2 Nylon material, natural color—**641777-1**
UL94V-0 Nylon material—**641778-1**

For 2 In-Line and 6 Matrix Circuit Cap Housings Only

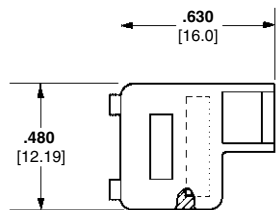

UL94V-2 Nylon material, natural color—**643182-1**
UL94V-0 Nylon material—**643182-2**

| Style | Number of Circuits | A Dim. | Insert Supplied | Single Wire Dia. Range | Wire Bundle Dia. Range | Part Numbers | |
|---------|--------------------|----------------|-----------------|------------------------|-------------------------|------------------------------|---------------|
| | | | | | | UL94V-2 Nylon, Natural Color | UL94V-0 Nylon |
| In-Line | 2 | .960 24.38 | Yes | .040-.190 1.02-4.83 | — | 1-640719-0 | 640713-1 |
| | | | No | — | .200-.350 5.08-8.89 | 1-640719-1 | 640713-2 |
| | 3 | 1.140 28.96 | Yes | .040-.190 1.02-4.83 | — | 1-640720-0 | 640714-1 |
| | | | No | — | .200-.350 5.08-8.89 | 641763-1 | 641945-1 |
| | 4 | 1.325 33.65 | Yes | .040-.190 1.02-4.83 | — | 641775-1 | 641776-1 |
| | | | No | — | .200-.350 5.08-8.89 | 641775-2 | 641776-2 |
| | 5 | 1.530 38.86 | Yes | .040-.190 1.02-4.83 | — | 643030-3 | 643030-1 |
| | | | No | — | .200-.350 5.08-8.89 | 643030-2 | 643030-4 |
| | 6 Note 5 | 1.780 45.21 | Yes | .040-.190 1.02-4.83 | — | 643585-1 | 643313-1 |
| | | | No | — | .200-.350 5.08-8.89 | 643585-2 | 643313-2 |
| | 8 Note 5 | 2.280 56.08 | Yes | .040-.190 1.02-4.83 | — | — | 643314-1 |
| | | | No | — | .200-.350 5.08-8.89 | — | 643314-2 |
| Matrix | 6 | 1.030 26.16 | Yes | — | .120-.650 3.05-16.51 | 1-640721-0 | 640715-1 |
| | 9 | 1.030 26.16 | Yes | — | .120-.650 3.05-16.51 | 1-640722-0 | 640716-1 |
| | 12 | 1.280 32.51 | Yes | — | .150-.750 3.81-19.05 | 1-640723-0 | 640717-1 |
| | 15 | 1.530 38.86 | Yes | — | .200-.850 5.08-21.59 | 1-640724-0 | 640718-1 |
| | | | No | — | — | — | — |

Notes:

1. Cable clamping insert comes attached to strain relief. It can be used to provide additional adjustment for small wire bundles or discarded.
2. Insert to be positioned as shown by dotted lines.
3. Strain relief part number represents one-half of a strain relief. Two strain reliefs required per housing.
4. Must use cap housing adapters when attaching strain reliefs to a cap housing. Two adapters required per housing.
5. Strain reliefs for 6 and 8 circuit In-Line fits plug housings only.

Note: All part numbers are RoHS Compliant.

Standard Density

Universal MATE-N-LOK Connectors
.250 [6.35] Centerline

Universal MATE-N-LOK Flanged Cap Housings with Twist and Lock Feature

Product Facts

- Available in a 6, 9, and 12 circuit design
- Designed for household appliances where a bulkhead connector system is needed in conjunction with foam-in insulation
- Mates with standard Universal MATE-N-LOK plug housings (page 174)
- Accepts Universal MATE-N-LOK pin and socket contacts (page 167)
- Designed to utilize the Splash Proof/Sealed Universal MATE-N-LOK seals for additional sealing protection (pages 174-175)



Material and Finish

Housing—Nylon, UL 94V-0 or UL 94V-2 rated

Contacts—Phosphor Bronze or Brass

Plating—Pre-tin or Gold

Related Product Data

Contacts—pages 172-173

Plug Housings—page 174

Seals—page 180



**Recommended Panel Cutout
(for 6 and 9 Pos. Housings)**



Notes:

1. Recommended Panel Thickness: 0.76-2.29 [.030-.090]
2. Panel must be punched so that the housing enters the panel in the same direction as the punch.
3. Asymmetrical panel cutout provides polarization for Pin 1 location.

| Number of Circuits | Cap Housing Part Numbers | |
|--------------------|--------------------------|----------|
| | UL 94V-0 | UL 94V-2 |
| 6 | 794760-1 | 794714-1 |
| 9 | 794761-1 | 794715-1 |
| 12 | 794762-1 | 794716-1 |

Note: All part numbers are RoHS Compliant.

Universal MATE-N-LOK Sealed Bulkhead Connectors

Product Facts

- Bulkhead mount Universal MATE-N-LOK connector that facilitates sealed panel mounting and works with existing Universal MATE-N-LOK seals to provide a fully-sealed interconnection system
- Available in 4, 6, 9 and 12 positions
- Sealed, flange mount design
- Mates to standard Universal MATE-N-LOK plug housings
- Accepts standard Universal MATE-N-LOK contacts
- Works with standard Universal MATE-N-LOK connector interface and wire seals
- Anti-rotation feature aids installation
- Rear mount flange design enables use in wire harnesses
- Pins and sockets can be intermixed in the same housing
- UL Recognized, File No. E28476
- CSA Certified, File No. 1030930



Applications

- Vending Machines
- Industrial Machinery
- Lighting
- HVAC Equipment



Performance Characteristics

Dielectric Withstanding Voltage—5.0 KVAC or 5.0 KVDC between adjacent circuits

Insulation Resistance—1000 megohms minimum initial between adjacent circuits

Voltage Rating—600 V AC or DC

Durability—50 cycles, mating and unmating

Technical Documents

Product Specification
108-1031 Universal MATE-N-LOK Connectors

Application Specification
114-1010 Universal MATE-N-LOK Contacts

Instruction Sheet
408-10017 Universal MATE-N-LOK Bulkhead Connectors

Universal MATE-N-LOK Sealed Bulkhead Connectors (Continued)

Connector Housings

4 Position Connector Housing (shown)

Material and Finish

- Housing**—Nylon, UL 94V-0 rated
- Contacts**—Brass with pre-tin or gold plating
- O-ring Seal**—Neoprene
- Locking Nut**—Steel, zinc plated



Recommended Panel Cut-Out for 4, 6 & 9 Position Product Only



Recommended Panel Cut-Out for 12 Position Product Only

| No. of Pos. | Style | Housing Part Number |
|-------------|---------|---------------------|
| 4 | In Line | 1604256-1 |
| 6 | Matrix | 1604210-1 |
| 9 | Matrix | 1604254-1 |
| 12 | Matrix | 1604941-1 |

Note: All part numbers are RoHS Compliant.

Universal MATE-N-LOK Sealed Connectors

Splash Proof Seals

Product Facts

- Economical splash proof/immersion sealed connector system
- No design changes to existing Universal MATE-N-LOK product
- Existing applications utilizing Universal MATE-N-LOK connectors can be upgraded to a splash proof system
- Utilizes two wire seals and one interface seal
- Wire range is 20-14 AWG [.5-2.0] with insulation diameter range .060-.130 [1.52-3.30]
- .110-.130 [2.79-3.30] insulation diameter passed European IP sealing level 5/6 + 7 (swirling dust/immersion to 1 meter for 30 minutes)
- .060-.110 [1.52-2.79] insulation diameter passed European IP sealing level 5/5 + 7 (swirling dust/heavy seas)
- Universal MATE-N-LOK II keying plug can be used to seal unused circuits
- Primary application is for wire-to-wire; wire-to-board application must use a closed bottom header

Material

Silicone rubber, blue color

Technical Documents

Product Specification

108-1031-1 Splash Proof Seal, Universal MATE-N-LOK Connectors

Contacts—page 175

Housings—page 174

Instruction Sheet

408-3392 Universal MATE-N-LOK Splash Proof Seals

Note: For proper use of this product, customer should make sure that Instruction Sheet 408-3392 is available for review.

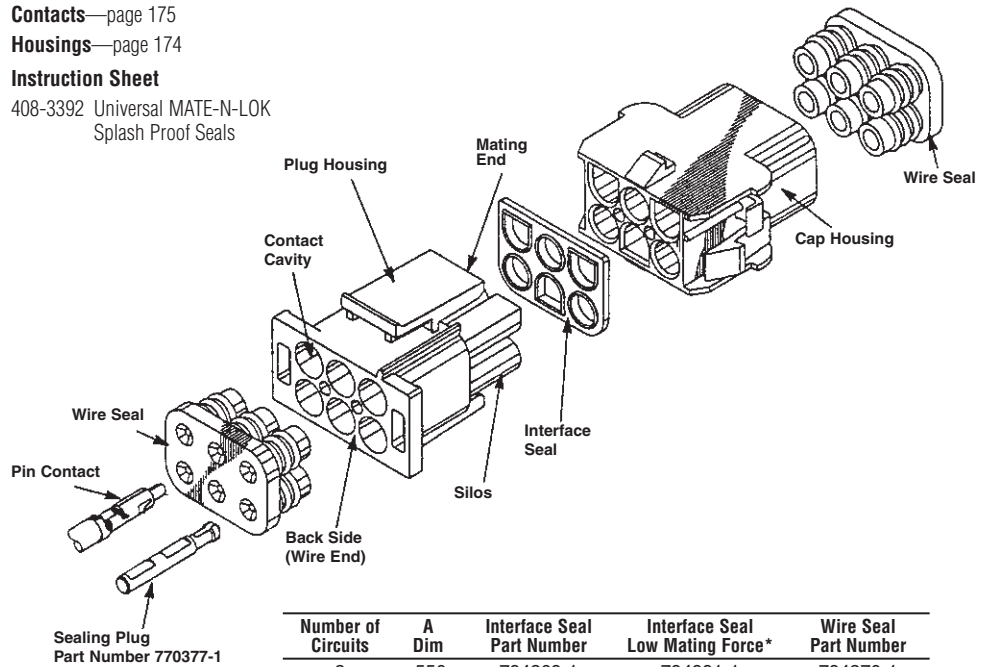

| Number of Circuits | A Dim | Interface Seal Part Number | Interface Seal Low Mating Force* | Wire Seal Part Number |
|--------------------|-------|----------------------------|----------------------------------|-----------------------|
| 2 | .550 | 794269-1 | 794991-1 | 794270-1 |
| 3 | .800 | 794271-1 | 794992-1 | 794272-1 |
| 4 | 1.050 | 794273-1 | — | 794274-1 |
| 6 | — | 794275-1 | 794993-1 | 794276-1 |
| 9 | .800 | 794277-1 | 794994-1 | 794278-1 |
| 12 | 1.050 | 794279-1 | — | 794280-1 |
| 15 | 1.300 | 794281-1 | — | 794282-1 |

Note: One interface seal and two wire seals required per mated assembly. *Low mating force interface seals do not meet IP 5/6 IP 5/7 requirements.

Note: All part numbers are RoHS Compliant.

Standard Density

2, 3, 4 Circuit, In-Line



6 Circuit, Matrix



9, 12, and 15 Circuit, Matrix



Universal MATE-N-LOK Sealed Connectors (Continued)

Contacts (used with Splash Proof Seals)

Solid pin diameter .084 [2.13]
Split pin diameter .086 [2.18]
Stock thickness .012 [.305] unless otherwise noted.
These contacts can be used in either Universal MATE-N-LOK Plug or Cap housings **only**.

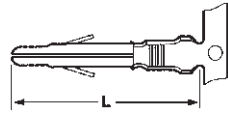

Solid Pin

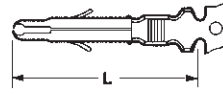

Split Pin

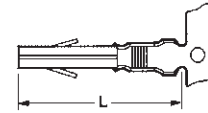

Socket

Related Product Data

Product Specification

108-1031 Universal MATE-N-LOK Connectors

Application Specification

114-1010 Universal MATE-N-LOK Contacts

Performance Characteristics—pages 169-170

Technical Documents—pages 169 and 205-206

Application Tooling—pages 207-210

Housings—page 174

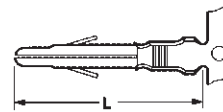

Grounding Pin

(100 [2.54] longer than standard pin)
(Mate first, break last, not for interrupting current)

| Wire Size Range AWG [mm ²] | Ins. Dia. Range | L Dim. | | Material & Finish | Style | Contact Part Numbers | | | | HDM Applicator Part No. | Hand Tool Part No. |
|---|--------------------------|---------------------------------|---------------|--------------------------------------|-----------|----------------------|-------------|------------|-------------|---|--------------------|
| | | Pin | Socket | | | Pin | | Socket | | | |
| | | | | | | Strip Form | Loose Piece | Strip Form | Loose Piece | | |
| 20-14 [.5-2.0] | .060-.130 [1.52-3.30] | .790 20.06 | .760 19.30 | Brass, Pre-tin | Solid | 350218-1 | 350547-1 | 350536-1 | 350550-1 | 687763-1 ³ 687763-2 ³ 687763-6 ³ | 91500-1 |
| | | | | Brass, Gold ¹ | | 350218-2 | 350547-2 | 350536-2 | 350550-2 | | |
| | | | | Brass, Select Gold ² | | 350218-7 | 350547-7 | 350536-7 | 350550-7 | | |
| | | | | Phos. Brz., Pre-tin | | 350218-3 | 350547-3 | 350536-3 | 350550-3 | | |
| | | | | Phos. Brz., Select Gold ² | | 350218-6 | 350547-6 | 350536-6 | 350550-6 | | |
| | | Brass, Pre-tin | 350687-1 | 350705-1 | — | — | | | | | |
| | | Brass, Gold ¹ | 350687-2 | 350705-2 | — | — | | | | | |
| | | Brass, Select Gold ² | 350687-7 | 350705-7 | — | — | | | | | |
| | | .890 22.60 | — | Brass, Pre-Tin | Grounding | 350654-1 | 350669-1 | — | — | | |

¹Gold Finish—Plated with .000030 [.000762] min. gold in mating area and inside wire barrel over .000050 [.00127] min. nickel underplate on entire contact.
²Select Gold Finish—Plated with .000030 [.000762] min. gold in mating area over .000050 [.00127] min. nickel underplate on entire contact.
³HDM Applicator part number ending in -1, is used on AMPOMATOR CLS Machine with T or G Terminators, -2 is used on AMP-O-LECTRIC Model K Machine, -4 & -6 are used on AMP-O-LECTRIC Model G Machine. See pages 207-210 for further information.

Notes:

1. Split pins recommended for use in housings having 6, 9, 12 and 15 circuits to reduce mating force.
2. Phosphor bronze material contacts are available for use in high temperature/humidity cycling applications, consult Tyco Electronics.
3. 18-24 AWG contacts (page 166) can be used with splash proof seals if insulation diameter range is .060-.100 [1.52-2.54].

Universal MATE-N-LOK II Keying Plug/Splash Proof Sealing Plug

IS 408-3392



Part Number
UL94V-0 Nylon material—770377-1

Related Product Data

Housings—page 174
Technical Documents—pages 169 and 205-206

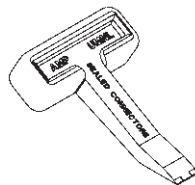

Seal Latch Tool
Part No. 794381-1
IS 408-3392



Contact Extraction Tool
Part No. 318851-1
IS 408-4371



Contact Insertion Tool (For inserting contacts applied to small diameter wire)
Part No. 91002-1
IS 408-7347

Note: All part numbers are RoHS Compliant.

Universal MATE-N-LOK Connectors

PC Board Vertical Pin Headers

.250 [6.35] Centerline spacing

Material

Housing—

UL94V-2 Nylon, natural color
UL94V-0 Nylon

Contacts—Phosphor bronze

Solder tail diameter .062 [1.57]

Related Product Data

Product Specification

108-1053 Universal MATE-N-LOK
PC Board Headers

Performance Characteristics—
pages 169-170

Recommended PC Board Hole Layout—page 184

Technical Documents—pages 169
and 205-206

Mating Connectors

Universal MATE-N-LOK

Plug Housings—page 174

Universal MATE-N-LOK II

Plug Housings—pages 193-194

**2, 3, 4, 5, 6 and 8
Circuit, In-Line**



| Number of Circuits | A Dim. | Flammability Rating | Pin Finish | Pin Header Part Numbers | | | Mates with Plug Housing Part Number (Using Socket Contacts) | |
|--------------------|---------------------|---------------------|---------------------|----------------------------|--------------------------------------|------------------------|---|-------------------------|
| | | | | Standard Tail ² | Standard Tail Polarized ² | Long Tail ³ | Universal MATE-N-LOK | Universal MATE-N-LOK II |
| 2 | .550 13.97 | UL94V-2 | Pre-tin | 350428-1 | 641963-1 | 350582-1 | 1-480698-0 | — |
| | | | Duplex ¹ | 350428-4 | 641963-3 | 350582-4 | | |
| | | UL94V-0 | Pre-tin | 350786-1 | 641964-1 | 350787-1 | 350777-1 | 770017-1 |
| | | | Duplex ¹ | 350786-3 | 641964-3 | 350787-3 | | |
| 3 | .800 20.32 | UL94V-2 | Pre-tin | 350429-1 | 641965-1 | 350583-1 | 1-480700-0 | — |
| | | | Duplex ¹ | 350429-4 | — | 350583-4 | | |
| | | UL94V-0 | Pre-tin | 350789-1 | 641966-1 | 350790-1 | 350766-1 | 770018-1 |
| | | | Duplex ¹ | 350789-3 | — | 350790-3 | | |
| 4 | 1.050 26.67 | UL94V-2 | Pre-tin | 350430-1 | 641967-1 | 350584-1 | 1-480702-0 | — |
| | | | Duplex ¹ | 350430-4 | — | 350584-4 | | |
| | | UL94V-0 | Pre-tin | 350792-1 | 641968-1 | 350793-1 | 350779-1 | 770019-1 |
| | | | Duplex ¹ | 350792-3 | — | 350793-3 | | |
| 5 | 1.300 33.02 | UL94V-2 | Pre-tin | 640466-1 | 643405-1 | — | 1-480763-0 | — |
| | | | Duplex ¹ | 640466-3 | — | — | | |
| | | UL94V-0 | Pre-tin | 640900-1 | 643406-1 | — | 350809-1 | 770016-1 |
| | | | Duplex ¹ | 640900-3 | — | — | | |
| 6 | 1.550 39.37 | UL94V-2 | Pre-tin | 641832-1 | 643407-1 | — | 640585-1 | — |
| | | | Pre-tin | 641831-1 | 643408-1 | — | | |
| | | UL94V-0 | Pre-tin | 641825-1 | — | 770143-1 | 640586-1 | — |
| | | | Pre-tin | 641828-1 | 643410-1 | 770272-1 | 640582-1 | — |
| UL94V-0 | Duplex ¹ | — | 643410-3 | 770272-3 | — | — | | |

**6, 9, 12 and 15
Circuit, Matrix**



| Number of Circuits | A Dim. | Flammability Rating | Pin Finish | Pin Header Part Numbers | | | Mates with Plug Housing Part Number (Using Socket Contacts) | |
|--------------------|----------------|---------------------|---------------------|----------------------------|--------------------------------------|------------------------|---|-------------------------|
| | | | | Standard Tail ² | Standard Tail Polarized ² | Long Tail ³ | Universal MATE-N-LOK | Universal MATE-N-LOK II |
| 6 | .550 13.97 | UL94V-2 | Pre-tin | 350431-1 | 641969-1 | 350585-1 | 1-480704-0 | — |
| | | | Duplex ¹ | 350431-4 | — | 350585-4 | | |
| | | UL94V-0 | Pre-tin | 350711-1 | 641970-1 | 350732-1 | 350715-1 | 770020-1 |
| | | | Duplex ¹ | 350711-4 | 641970-3 | 350732-4 | | |
| 9 | .800 20.32 | UL94V-2 | Pre-tin | 350432-1 | 641971-1 | 350586-1 | 1-480706-0 | — |
| | | | Duplex ¹ | 350432-4 | 641971-3 | 350586-4 | | |
| | | UL94V-0 | Pre-tin | 350712-1 | 641972-1 | 350742-1 | 350720-1 | 770021-1 |
| | | | Duplex ¹ | 350712-4 | 641972-3 | 350742-4 | | |
| 12 | 1.050 26.67 | UL94V-2 | Pre-tin | 350433-1 | 641973-1 | 350587-1 | 1-480708-0 | — |
| | | | Duplex ¹ | 350433-4 | — | 350587-4 | | |
| | | UL94V-0 | Pre-tin | 350713-1 | 641974-1 | 350737-1 | 350735-1 | 770022-1 |
| | | | Duplex ¹ | 350713-4 | 641974-3 | 350737-4 | | |
| 15 | 1.300 33.02 | UL94V-2 | Pre-tin | 350434-1 | 641975-1 | 350588-1 | 1-480710-0 | — |
| | | | Duplex ¹ | 350434-4 | — | 350588-4 | | |
| | | UL94V-0 | Pre-tin | 350714-1 | 641976-1 | 350738-1 | 350736-1 | 770023-1 |
| | | | Duplex ¹ | 350714-4 | 641976-4 | 350738-4 | | |

Note: Header Housings on pages 182-185 are available in **colors** listed on page 188. Call Technical Support for exact Part Numbers.

¹Duplex Finish—Plated with .000030 [.000762] min. gold in mating area, matte tin on solder tail end over .000050 [.00127] min. nickel underplate on entire contact.
²Use Standard Tail for .062 [1.57] thick PC Board. ³Use Long Tail for .125 [3.18] thick PC Board.
⁴Black in color. ⁵No drain holes, used w/ seals, page 180. **Note: All part numbers are RoHS Compliant.**

Universal MATE-N-LOK Connectors (Continued)

PC Board Vertical Socket Headers

.250 [6.35] Centerline spacing

Material

Housing—

UL94V-2 Nylon, natural color
UL94V-0 Nylon

Contacts—Phosphor bronze

Solder tail diameter .062 [1.57]

Related Product Data

Product Specification

108-1053 Universal MATE-N-LOK
PC Board Headers

Performance Characteristics—
pages 169-170

Recommended PC Board Hole Layout—page 184

Technical Documents—pages 169
and 205-206

Mating Connectors

Universal MATE-N-LOK

Plug Housings—page 174

Universal MATE-N-LOK II

Plug Housings—pages 193-194

**2, 3, 4, 5, and 6
Circuit, In-Line**



| Number of Circuits | A Dim. | Flammability Rating | Socket Finish | Socket Header Part Numbers | | | Mates with Plug Housing Part Number (Using Pin Contacts) | |
|--------------------|----------------|---------------------|---------------------|----------------------------|--------------------------------------|------------------------|--|-------------------------|
| | | | | Standard Tail ² | Standard Tail Polarized ² | Long Tail ³ | Universal MATE-N-LOK | Universal MATE-N-LOK II |
| 2 | .550 13.97 | UL94V-2 | Pre-tin | 350759-4 | 643411-1 | 350986-4 | 1-480698-0 | — |
| | | | Duplex ¹ | 350759-5 | — | — | — | — |
| | | UL94V-0 | Pre-tin | 350824-1 | 643412-1 | 350831-1 | 350777-1 | 770017-1 |
| | | | Duplex ¹ | 350824-4 | 643412-3 | — | — | — |
| 3 | .800 20.32 | UL94V-2 | Pre-tin | 350760-4 | 643413-1 | 350987-4 | 1-480700-0 | — |
| | | | Duplex ¹ | 350760-5 | — | — | — | — |
| | | UL94V-0 | Pre-tin | 350825-1 | 643414-1 | 350832-1 | 350766-1 | 770018-1 |
| | | | Duplex ¹ | 350825-4 | 643414-3 | 350832-4 | — | — |
| 4 | 1.050 26.67 | UL94V-2 | Pre-tin | 350761-4 | 643415-1 | 350988-4 | 1-480702-0 | — |
| | | | Duplex ¹ | 350761-5 | — | 350988-5 | — | — |
| | | UL94V-0 | Pre-tin | 350826-1 | 643416-1 | 350833-1 | 350779-1 | 770019-1 |
| | | | Duplex ¹ | 350826-4 | — | 350833-4 | — | — |
| 5 | 1.300 33.02 | UL94V-2 | Pre-tin | 640467-1 | — | — | 1-480763-0 | — |
| | | | Duplex ¹ | 640467-3 | — | — | — | — |
| | | UL94V-0 | Pre-tin | 640901-1 | — | — | 350809-1 | 770016-1 |
| | | | Duplex ¹ | 640901-3 | — | — | — | — |
| 6 | 1.550 39.37 | UL94V-0 | Duplex ¹ | 770262-3 | — | — | 640581-1 | — |

**6, 9, 12 and 15
Circuit, Matrix**



| Number of Circuits | A Dim. | Flammability Rating | Socket Finish | Socket Header Part Numbers | | | Mates with Plug Housing Part Number (Using Pin Contacts) | |
|--------------------|----------------|---------------------|---------------------|----------------------------|--------------------------------------|------------------------|--|-------------------------|
| | | | | Standard Tail ² | Standard Tail Polarized ² | Long Tail ³ | Universal MATE-N-LOK | Universal MATE-N-LOK II |
| 6 | .550 13.97 | UL94V-2 | Pre-tin | 350762-4 | 643423-1 | 350989-4 | 1-480704-0 | — |
| | | | Duplex ¹ | 350762-5 | — | 350989-5 | — | — |
| | | UL94V-0 | Pre-tin | 350827-1 | 643424-1 | 350834-1 | 350715-1 | 770020-1 |
| | | | Duplex ¹ | 350827-4 | 643424-3 | 350834-4 | — | — |
| 9 | .800 20.32 | UL94V-2 | Pre-tin | 350763-4 | 643425-1 | 350990-4 | 1-480706-0 | — |
| | | | Duplex ¹ | 350763-5 | — | 350990-5 | — | — |
| | | UL94V-0 | Pre-tin | 350828-1 | 643426-1 | 350835-1 | 350720-1 | 770021-1 |
| | | | Duplex ¹ | 350828-4 | 643426-3 | 350835-4 | — | — |
| 12 | 1.050 26.67 | UL94V-2 | Pre-tin | 350764-4 | — | 350991-4 | 1-480708-0 | — |
| | | | Duplex ¹ | 350764-5 | — | 350991-5 | — | — |
| | | UL94V-0 | Pre-tin | 350829-1 | 643428-1 | 350836-1 | 350735-1 | 770022-1 |
| | | | Duplex ¹ | 350829-4 | — | 350836-4 | — | — |
| 15 | 1.300 33.02 | UL94V-2 | Pre-tin | 350765-4 | 643429-1 | 350992-4 | 1-480710-0 | — |
| | | | Duplex ¹ | 350765-5 | — | — | — | — |
| | | UL94V-0 | Pre-tin | 350830-1 | 643430-1 | 350837-1 | 350736-1 | 770023-1 |
| | | | Duplex ¹ | 350830-4 | — | 350837-4 | — | — |

Note: Header Housings on pages 182-185 are available in colors listed on page 188. Call Technical Support for exact Part Numbers.

¹Duplex Finish—Plated with .000030 [.000762] min. gold in mating area, matte tin on solder tail end over .000050

[.00127] min. nickel underplate on entire contact.

²Use Standard Tail for .062 [1.57] thick PC Board.

³Use Long Tail for .125 [3.18] thick PC Board.

Note: All part numbers are RoHS Compliant.

Universal MATE-N-LOK Connectors (Continued)

Recommended PC Board Hole Layouts for Pin and Socket Vertical Headers

Related Product Data
Vertical Headers—pages 182-183

2, 3, 4, 5, 6 and 8 Circuit, In-Line



6, 9, 12 and 15 Circuit, Matrix



Note: Polarizing hole .070 [1.78] Dia. required for polarized headers only.

PC Board Vertical Pin Headers with ACTION PIN Contacts

Material and Finish
Housing—PBT, black
Flammability Rating—UL94V-0
Contacts—Copper alloy, plated with tin over nickel on entire contact



Related Product Data

Performance Characteristics—pages 169-170
Technical Documents—pages 169 and 205-206

Product Specification
108-5222 ACTION PIN Universal MATE-N-LOK Header Assembly

Mating Connectors

Universal MATE-N-LOK
Plug Housings—page 174

Universal MATE-N-LOK II
Plug Housings—pages 193-194

Note: Header Housings on pages 182-185 are available in colors listed on page 188. Call Technical Support for exact Part Numbers.

| Number of Circuits | A Dim. | Part Number | Mates with Plug Housing Part Number (Using Socket Contacts) | |
|--------------------|----------------|-------------|---|-------------------------|
| | | | Universal MATE-N-LOK | Universal MATE-N-LOK II |
| 2 | .750 19.05 | 173924-1 | 1-480698-0 350777-1 | 770017-1 |
| 3 | 1.000 25.40 | 173925-1 | 1-480700-0 350766-1 | 770018-1 |
| 4 | 1.250 31.75 | 173926-1 | 1-480702-0 350779-1 | 770019-1 |

Note: Install in PC Board with arbor tool.
Note: All part numbers are RoHS Compliant.



Recommended PC Board Hole Layout

PC Board Hole Dimensions

Standard Density
Universal MATE-N-LOK Connectors
.250 [6.35] Centerline

Universal MATE-N-LOK Connectors (Continued)

PC Board Right-Angle Pin and Socket Headers

.250 [6.35] Centerline spacing

Material

Housing — Nylon

Contacts — Phosphor bronze

Solder tail width .052 [1.32]

Related Product Data

Product Specification

108-1053 Universal MATE-N-LOK
PC Board Headers

Performance Characteristics —

pages 169-170

Technical Documents — pages 169 and 205-206

Mating Connectors

Universal MATE-N-LOK

Plug Housings — page 174

Universal MATE-N-LOK II

Plug Housings — pages 193-194

Note: Header Housings on pages 182-185 are available in colors listed on page 188. Call Technical Support for exact Part Numbers.

Test Connectors (with spring loaded contacts)

Material

Housing — Nylon

Flammability Rating — UL94V-0

Related Product Data

Mating Connectors — Housings and headers having the same number of circuits. The housings can have pin or socket contacts, or a combination of both.

Mating Housings — page 174

Mating Headers — pages 182-185

Other Mating Connectors

Universal MATE-N-LOK II Housings — pages 193-194

Notes:

1. Test probes have 5 amp maximum current rating, 1,000,000 cycles.
2. Test Connector housings are of the same configuration as standard housings. Refer to page 23 for dimensional specifications.

2, 3, 4, 5, 6 and 8 Circuit, In-Line

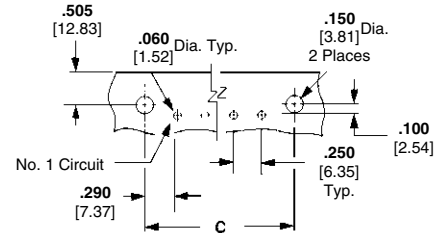

Use 6-32 UNC Pan Head Screw
3/8 [9.53] long for mounting
(Not Supplied)

Recommended PC Board Hole Layout
.062 [1.57] Board Thickness

| No. of Circuits | Dimensions | | | Contact Finish | Right-Angle Header Part Numbers | | | | | | |
|-----------------|----------------|----------------|----------------|---------------------|---------------------------------|----------|------------|------------|------------|------------|----------|
| | A | B | C | | UL94V-2 | | | UL94V-0 | | | |
| | | | | | Pin | Socket | Mates with | Pin | Socket | Mates with | |
| 2 | .550 13.97 | 1.245 31.62 | .830 21.08 | Pre-tin | — | — | — | 1-350942-0 | 643226-1 | 350777-1 | 770017-1 |
| | | | | Duplex ¹ | — | — | — | 3-350942-0 | — | | |
| 3 | .800 20.32 | 1.495 37.97 | 1.080 27.43 | Pre-tin | — | — | — | 1-350943-0 | 643228-1 | 350766-1 | 770018-1 |
| | | | | Duplex ¹ | — | — | — | 3-350943-0 | 3-643228-0 | | |
| 4 | 1.050 26.67 | 1.745 44.32 | 1.330 33.78 | Pre-tin | 1-350948-0 | — | — | 1-350944-0 | 643230-1 | 350779-1 | 770019-1 |
| | | | | Duplex ¹ | — | — | 1-480702-0 | 3-350944-0 | 3-643230-0 | | |
| 5 | 1.300 33.02 | 1.995 50.67 | 1.580 40.13 | Pre-tin | 1-350949-0 | — | — | 1-350945-0 | 643232-1 | 350809-1 | 770016-1 |
| | | | | Duplex ¹ | — | — | 1-480763-0 | 3-350945-0 | 3-643232-0 | | |
| 6 | 1.550 39.37 | 2.245 57.02 | 1.830 46.48 | Pre-tin | 640587-1 | — | — | 640583-1 | 643234-1 | 640581-1 | — |
| | | | | Duplex ¹ | — | 643235-1 | 640585-1 | 640583-3 | 3-643234-0 | | |
| 8 | 2.050 52.07 | 2.745 69.72 | 2.330 59.18 | Pre-tin | — | — | — | 640584-1 | 643236-1 | 640582-1 | — |
| | | | | Duplex ¹ | — | 643237-1 | 640586-1 | 640584-3 | 3-643236-0 | | |

¹Duplex Finish — Plated with .000030 [.000762] min. gold in mating area, matte tin on solder tail end over .000050 [.00127] min. nickel underplate on entire contact. ²Black in color.

2, 3, 4 and 5 Circuit, In-Line

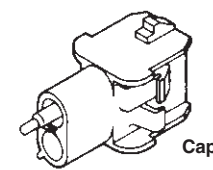
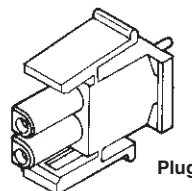

6, 9, 12 and 15 Circuit, Matrix

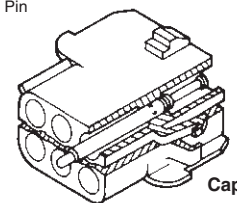
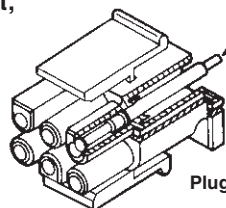

.084 [2.13] Dia. Pin
Mates with
Universal
MATE-N-LOK
Sockets

| Number of Circuits | Part Numbers | |
|--------------------|--------------|------------|
| | Plug | Cap |
| 2 | 350848-2 | 350849-2 |
| 3 | 350848-3 | 350849-3 |
| 4 | 350848-4 | 350849-4 |
| 5 | 350848-5 | 350849-5 |
| 6 | 350848-6 | 350849-6 |
| 9 | 350848-9 | 350849-9 |
| 12 | 1-350848-2 | 1-350849-2 |
| 15 | 1-350848-5 | 1-350849-5 |

Note: All part numbers are RoHS Compliant.

Universal MATE-N-LOK Circular Connectors

Product Facts

- Unique product designed to accommodate the specific needs of the lighting industry
- Circular design allows the connector to pass through 7/8 inch knock-out holes in electrical fixtures and boxes
- 6-position accommodates most major electrical industry requirements
- Universal MATE-N-LOK connector centerline spacing maintains UL and CSA approvals
- Uses standard Universal MATE-N-LOK contacts and application tooling
- Positive polarized housing helps prevent incorrect mating
- UL Recognized, File No. E28476 
- CSA Certified, File No. LR7189 



Applications

- Primary applications are in the Lighting, Vending, and Appliance industries
- Applications where use of a completed harness that will pass through a 7/8 inch knock-out is required
- Provides the capability to quickly disconnect individual fixtures from sensitive environmental areas and perform maintenance at other sites
- Not for interrupting current

Performance Characteristics

- Voltage**—600 V AC or DC
- Current**—20 amps maximum per UL-1977 (6 position, fully energized)
- Dielectric Withstanding Voltage**—5 KVAC or KVDC
- Insulation Resistance**—1000 M Ω max. between adjacent circuits
- Durability**—50 cycles mating and unmating
- Contact Retention**—15 lb. minimum per contact

Technical Documents

- Product Specification**
108-2069 Universal MATE-N-LOK Circular Connector
- Application Specification**
114-1010 Universal MATE-N-LOK Connectors

Standard Density

Universal MATE-N-LOK Circular Connectors
.250 [6.35] Centerline

Universal MATE-N-LOK Circular Connectors (Continued)

Plug

Part No. 794911-1



Cap

Part No. 794912-1



Material and Finish

Housings—Nylon, UL 94V-2 rated

Related Product Data

Contacts—pages 172-173

Note: All part numbers are RoHS Compliant.

Universal MATE-N-LOK Connectors — Available in Colors

Note: See corresponding Universal MATE-N-LOK Plug and Cap Housing Base Part Numbers on page 175.

Header Housings on pages 182-185 are also available in **colors**. Call Technical Support for exact Part Numbers.

| Base Part Number | No. of Circuits | Housing | Material |
|------------------|-----------------|---------|----------|
| 480698 | 2 | Plug | V-2 |
| 480699 | 2 | Cap | V-2 |
| 480700 | 3 | Plug | V-2 |
| 480701 | 3 | Cap | V-2 |
| 480702 | 4 | Plug | V-2 |
| 480703 | 4 | Cap | V-2 |
| 480763* | 5 | Plug* | V-2 |
| 480764* | 5 | Cap* | V-2 |
| 480704 | 6 | Plug | V-2 |
| 480705 | 6 | Cap | V-2 |
| 480706 | 9 | Plug | V-2 |
| 480707 | 9 | Cap | V-2 |
| 480708 | 12 | Plug | V-2 |
| 480709 | 12 | Cap | V-2 |
| 480710 | 15 | Plug | V-2 |
| 480711 | 15 | Cap | V-2 |
| 350777 | 2 | Plug | V-0 |
| 350778 | 2 | Cap | V-0 |
| 350766 | 3 | Plug | V-0 |
| 350767 | 3 | Cap | V-0 |
| 350799 | 4 | Plug | V-0 |
| 350780 | 4 | Cap | V-0 |
| 350809 | 5 | Plug | V-0 |
| 350810 | 5 | Cap | V-0 |
| 350715 | 6 | Plug | V-0 |
| 350781 | 6 | Cap | V-0 |
| 350720 | 9 | Plug | V-0 |
| 350782 | 9 | Cap | V-0 |
| 350735 | 12 | Plug | V-0 |
| 350783 | 12 | Cap | V-0 |
| 350736 | 15 | Plug | V-0 |
| 350784 | 15 | Cap | V-0 |

| Dash Number | Color |
|-------------|---------|
| 1-xxxxxx-0 | Natural |
| 1-xxxxxx-1 | Brown |
| 1-xxxxxx-2 | Red |
| 1-xxxxxx-3 | Orange |
| 1-xxxxxx-4 | Yellow |
| 1-xxxxxx-5 | Green |
| 1-xxxxxx-6 | Blue |
| 1-xxxxxx-8 | Gray |
| 1-xxxxxx-9 | Black |

*** Special for Base Part Numbers 480763 and 480764**

| Dash Number | Color |
|-------------|---------|
| xxxxxx-1 | Natural |
| 1-xxxxxx-1 | Brown |
| 1-xxxxxx-2 | Red |
| 1-xxxxxx-3 | Orange |
| 1-xxxxxx-4 | Yellow |
| 1-xxxxxx-5 | Green |
| 1-xxxxxx-6 | Blue |
| 1-xxxxxx-8 | Gray |
| 1-xxxxxx-9 | Black |

Standard Density

Universal MATE-N-LOK Connectors — Available in Colors
.250 [6.35] Centerline

Universal MATE-N-LOK II Connectors

Product Facts

- High reliability
- For use where repair or replacement would be difficult
- Pins and sockets can be intermixed in the same housing
- Available in 2 through 15 circuit sizes for free-hanging or panel mount wire-to-wire connection
- Mate with standard Universal MATE-N-LOK Housings and PC Board Headers
- Uses standard Universal MATE-N-LOK panel cutouts and strain reliefs
- Polarized housings available in UL94V-0 flammability rated material
- Enclosed contacts for shock protection
- F-Crimp terminals accept 30-10 AWG [.05-5.0 mm²] wire sizes
- Contacts available in strip and loose form
- Lanceless contacts for tangle-free handling
- Insulation capability to .200 [5.08] diameter
- Connector design provides for complete contact insertion
- Three-point stabilization precisely controls contact alignment, minimizing stubbing
- Tin or duplex gold plated contacts
- Contacts are on .250 [6.35] centerline spacing
- Not for interrupting current
- Recognized under the Component Program of Underwriters Laboratories Inc., File No. E28476
- Certified by Canadian Standards Association, File No. LR 7189
- Passed test by VDE under their Registration Number 3980/Continuous Surveillance

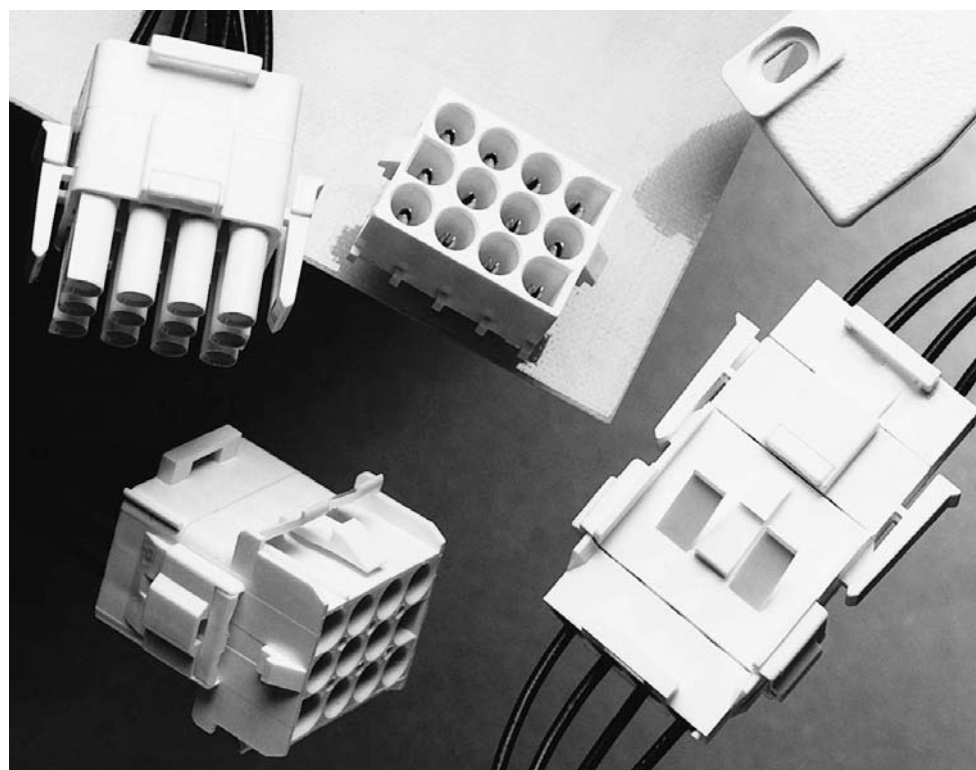

Performance Characteristics

The Universal MATE-N-LOK II Connector performance characteristics found on pages 189-190 are based on free-hanging and panel mount connectors, loaded with contacts crimped on stranded wire.

Dielectric Withstanding Voltage—5.0 KV AC or DC between adjacent circuits initially

Insulation Resistance—1000 megohms minimum between adjacent circuits

Voltage Rating—600 V AC or DC

Connector Mating—Split Pin—1.5 lb. max. per circuit

Connector Unmating—Split Pin—.5 lb. min. per circuit

Contact Insertion Force—3.0 lb. max. per contact unassembled

Contact Retention—35 lb. min. per contact

Durability—50 cycles, mating and unmating

Technical Documents

Product Specification

108-1090 Universal MATE-N-LOK II Connectors

Application Specification

114-1043 Universal MATE-N-LOK II Connectors

Instruction Sheet

408-3200 Housing, Contacts and Accessories

Universal MATE-N-LOK II Connectors (Continued)

Performance Characteristics (Continued)

Maximum Current—Maximum current rating of Universal MATE-N-LOK II connectors is limited by the maximum operating temperature of the housings which is 120°C including the temperature rise of the contacts which is a maximum of 30°C. There are several variables which have a direct effect on this maximum current-carrying capability for a given connector and must be considered for each application. These variables are:

Wire Size—Larger diameter wire will carry more current since it has less internal resistance to current flow and thus generates less heat. Longer wire lengths also enhance current carrying capabilities since the wire conducts heat away from the connector.

Connector Size—In general, the more circuits in a connector, the less current can be carried.

Ambient Temperature—The higher the ambient temperature, the less current can be carried in any given connector.

Universal MATE-N-LOK II connectors also will withstand the following tests:

Vibration—10-55-10 cycles per minute at .06 inch total excursion

Physical Shock—18 drops, 50 g sawtooth at 10 milliseconds

Housing Panel Retention—75 lb. min.

Housing Lock Strength—35 lb. min.

Thermal Shock—-55°C to +85°C

Temperature-Humidity Cycling—25°C to 65°C at 95 RH

Corrosion—48 hr. at 5% salt concentration

Current Rating Verification for 30°C Maximum Temperature Rise 100% Energized

Wire-to-Wire

Calculated Current Table

| Number of Circuits | Wire Gauge | | | | | | | | | |
|--------------------|------------|-------|-------|-------|-------|-------|------|------|------|------|
| | 10 | 12 | 14 | 16 | 18 | 20 | 22 | 24 | 26 | 30 |
| 2 | 19.00 | 18.00 | 17.00 | 14.50 | 13.00 | 10.00 | 8.00 | 6.50 | 5.50 | 3.50 |
| 3 | 17.50 | 16.50 | 15.50 | 13.00 | 12.00 | 9.00 | 7.50 | 6.00 | 5.00 | 3.00 |
| 4 | 16.50 | 15.50 | 15.00 | 12.50 | 11.00 | 8.50 | 7.00 | 5.50 | 4.50 | 3.00 |
| 5 | 16.00 | 15.00 | 14.00 | 12.00 | 10.50 | 8.00 | 6.50 | 5.50 | 4.50 | 3.00 |
| 6 Matrix | 15.00 | 14.00 | 13.00 | 11.00 | 9.50 | 7.50 | 6.00 | 5.00 | 4.00 | 2.50 |
| 8 | 14.50 | 14.00 | 13.00 | 10.50 | 9.50 | 7.50 | 6.00 | 5.00 | 4.00 | 2.50 |
| 9 | 13.50 | 12.50 | 11.50 | 9.50 | 8.50 | 6.50 | 5.50 | 4.50 | 3.50 | 2.00 |
| 10 | 14.00 | 13.00 | 12.50 | 10.00 | 9.00 | 7.00 | 5.50 | 4.50 | 3.50 | 2.50 |
| 12 | 12.50 | 12.00 | 11.00 | 9.00 | 8.00 | 6.00 | 5.00 | 4.00 | 3.00 | 2.00 |
| 15 | 12.00 | 11.50 | 10.00 | 8.50 | 7.50 | 6.00 | 4.50 | 4.00 | 3.00 | 2.00 |

Values are based on initial Temperature Rise versus Current Testing and are intended to be a guide in the selection of a connector family. All applications should be tested by the end user. The values listed are per circuit for fully loaded housings being 100% energized. **Note:** All combinations were not tested, and this chart contains interpolated and extrapolated values.

Minimum Wire Lengths for T-Rise vs. Current Testing

| AWG | Min. Length (in.) | AWG | Min. Length (in.) |
|-----|-------------------|-----|-------------------|
| 30 | 2.6 | 18 | 9.4 |
| 28 | 3.2 | 16 | 11.3 |
| 26 | 4.1 | 14 | 13.7 |
| 24 | 5.1 | 12 | 16.4 |
| 20 | 7.8 | 10 | 19.3 |

Note: If wire lengths used are less than those listed above, the current carrying ability of the system will be reduced due to less heat being conducted away from the connector. The customer should fully test all applications.

Wire-to-Board

Due to the vast differences in trace geometry and printed circuit board configurations, we are unable to provide a separate current carrying chart for our printed circuit board header products. However, the above Wire-to-Wire charts may be used as a guideline for headers if the trace width and thickness is equal to the listed wire gauge. For vertical headers, only 95% of the Wire-to-Wire value should be used. For right-angle headers, only 75% of the Wire-to-Wire value should be used. The chart values are only a tool for connector selection and will require the customer to fully test their application.

Termination Resistance/Contact Crimp Tensile Force

| Wire Size | | Termination Resistance | | Contact Crimp Tensile Force | |
|-----------|-----------------|------------------------|-----------------------------------|-----------------------------|-----|
| AWG | mm ² | Test Current (Amps) | Resistance Milliohms (Max. Init.) | Force (Min.) | |
| | | | | lbs. | N |
| 30 | .05 | — | — | 1.5 | 7 |
| 28 | .08 | — | — | 3 | 13 |
| 26 | .12 | — | — | 5 | 22 |
| 24 | .2 | 1.5 | 3.50 | 7 | 31 |
| 22 | .3 | 3 | 3.50 | 12 | 53 |
| 20 | .5 | 4.5 | 3.00 | 17 | 66 |
| 18 | .8 | 6 | 3.00 | 30 | 133 |
| 16 | 1.2 | 8 | 2.75 | 45 | 200 |
| 14 | 2.0 | 10 | 2.75 | 50 | 222 |
| 12 | 3.0 | — | — | 60 | 267 |
| 10 | 5.0 | — | — | 70 | 311 |

Note: This is the total resistance between wire crimps of a mated pin and socket.

Related Product Data

Product Specification

108-1090 Universal MATE-N-LOK II Connectors

Standard Density

Universal MATE-N-LOK II Connectors .250 [6.35] Centerline

Universal MATE-N-LOK II Connectors (Continued)

Universal MATE-N-LOK II Connector Mating Combinations

| Connector Part Number | | | | Mating Connector Part Number | | | | | | | | | |
|-----------------------|---------------------|---------|-----------------------------------|----------------------------------|---------------------|---------------------------|-------------------------|-----------|------------------------------|-------------------------|-----------|--------------------------|------------|
| Number of Circuits | Flammability Rating | Style | Plug Kit Part Number ² | Cap Kit Part Number ² | Plating | Vertical Pin ² | | | Vertical Socket ² | | | Right-Angle ² | |
| | | | | | | Standard Tail | Standard Tail Polarized | Long Tail | Standard Tail | Standard Tail Polarized | Long Tail | Pin | Socket |
| 2 | UL94V-0 | In-Line | 770017-1 | 770024-1 | Pre-tin | 350786-1 | 641964-1 | 350787-1 | 350824-1 | 643412-1 | 350831-1 | 1-350942-0 | 643226-1 |
| | | | | | Duplex ¹ | 350786-3 | 641964-3 | 350787-3 | 350824-4 | 643412-3 | — | 3-350942-0 | — |
| 3 | UL94V-0 | In-Line | 770018-1 | 770025-1 | Pre-tin | 350789-1 | 641966-1 | 350790-1 | 350825-1 | 643414-1 | 350832-1 | 1-350943-0 | 643228-1 |
| | | | | | Duplex ¹ | 350789-3 | — | 350790-3 | 350825-4 | 643414-3 | 350832-4 | 3-350943-0 | 3-643228-0 |
| 4 | UL94V-0 | In-Line | 770019-1 | 770026-1 | Pre-tin | 350792-1 | 641968-1 | 350793-1 | 350826-1 | 643416-1 | 350833-1 | 1-350944-0 | 643230-1 |
| | | | | | Duplex ¹ | 350792-3 | — | 350793-3 | 350826-4 | — | 350833-4 | 3-350944-0 | 3-643230-0 |
| 5 | UL94V-0 | In-Line | 770016-1 | — | Pre-tin | 640900-1 | 643406-1 | — | 640901-1 | — | — | 1-350945-0 | 643232-1 |
| | | | | | Duplex ¹ | 640900-3 | — | — | 640901-3 | — | — | 3-350945-0 | 3-643232-0 |
| 6 | UL94V-0 | Matrix | 770020-1 | 770027-1 | Pre-tin | 350711-1 | 641970-1 | 350732-1 | 350827-1 | 643424-1 | 350834-1 | — | — |
| | | | | | Duplex ¹ | 350711-4 | 641970-3 | 350732-4 | 350827-4 | 643424-3 | 350834-4 | — | — |
| 9 | UL94V-0 | Matrix | 770021-1 | 770028-1 | Pre-tin | 350712-1 | 641972-1 | 350742-1 | 350828-1 | 643426-1 | 350835-1 | — | — |
| | | | | | Duplex ¹ | 350712-4 | 641972-3 | 350742-4 | 350828-4 | 643426-3 | 350835-4 | — | — |
| 12 | UL94V-0 | Matrix | 770022-1 | 770029-1 | Pre-tin | 350713-1 | 641974-1 | 350737-1 | 350829-1 | 643428-1 | 350836-1 | — | — |
| | | | | | Duplex ¹ | 350713-4 | 641974-3 | 350737-4 | 350829-4 | — | 350836-4 | — | — |
| 15 | UL94V-0 | Matrix | 770023-1 | 770030-1 | Pre-tin | 350714-1 | 641976-1 | 350738-1 | 350830-1 | 643430-1 | 350837-1 | — | — |
| | | | | | Duplex ¹ | 350714-4 | 641976-4 | 350738-4 | 350830-4 | — | 350837-4 | — | — |

¹Duplex Finish — Plated with .000030 [.000762] min. gold in mating area, matte tin on solder tail end over .000050 [.00127] min. nickel underplate on entire contact.

²Universal MATE-N-LOK II Plug and Cap housings accept pin or socket contacts. Use the appropriate contacts in the Plug housing as required by the mating component.

Note: All part numbers are RoHS Compliant.

Standard Density

Universal MATE-N-LOK II Connectors
.250 [6.35] Centerline

Universal MATE-N-LOK II Connectors (Continued)

Contacts

Split pin diameter .086 [2.18]
Stock thickness .012 [.305]
These contacts can be used in either Universal MATE-N-LOK II Plug or Cap housings.

Related Product Data

Product Specification
108-1090 Universal MATE-N-LOK II Connectors

Application Specification
114-1043 Universal MATE-N-LOK II Contacts

Performance Characteristics—pages 189-190
Housings—pages 193-194

Technical Documents—pages 189 and 205-206
Application Tooling—pages 207-210

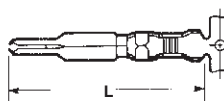

Pin

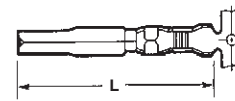

Socket

| Wire Size Range AWG [mm ²] | Ins. Dia. Range | L Dim. | | Material & Finish | Contact Part Numbers | | | | HDM Applicator Part No. | Hand Tool Part No. |
|---|--------------------------------|----------------|---------------|--------------------------------|----------------------|-------------|------------|-------------|---|--|
| | | Pin | Socket | | Pin | | Socket | | | |
| | | | | | Strip Form | Loose Piece | Strip Form | Loose Piece | | |
| 30-26 [.05-.12] | .032-.057 .813-1.45 | 1.005 25.53 | .980 24.90 | Phos. Brz. Gold ¹ | 770011-6 | 770512-6 | 770012-6 | 770416-6 | 567252-1 ⁶ 567252-4 ⁶ | 58439-1 |
| 24-18 [.2-.8] | .040-.100 1.02-2.54 | 1.005 25.53 | .980 24.90 | Brass. Pre-tin | 770009-1 | 770252-1 | — | — | 567214-1 ⁶ 567214-2 ⁶ 567214-4 ⁶ | 91510-1 |
| | | | | Brass. Duplex ² | 1-770009-0 | 1-770252-0 | — | — | | |
| | | | | Phos. Brz. Pre-tin | — | — | 770010-3 | 770253-3 | | |
| | | | | Phos. Brz. Duplex ² | — | — | 1-770010-0 | 1-770253-0 | | |
| 20-14 [.5-2.0] | .060-.130 1.52-3.30 | 1.005 25.53 | .980 24.90 | Brass. Pre-tin | 770007-1 | 770250-1 | — | — | 567213-1 ⁶ 567213-2 ⁶ 567213-4 ⁶ | 91500-1 |
| | | | | Brass. Duplex ² | 1-770007-0 | 1-770250-0 | — | — | | |
| | | | | Phos. Brz. Pre-tin | — | — | 770008-3 | 770251-3 | | |
| | | | | Phos. Brz. Duplex ² | — | — | 1-770008-0 | 1-770251-0 | | |
| 20-14 [.5-2.0] | .130-.200 3.30-5.08 | .995 25.27 | .970 24.63 | Brass. Pre-tin | 770005-1 | 770248-1 | — | — | 567212-1 ⁶ 567212-2 ⁶ 567212-4 ⁶ | 91508-1 ⁴ 91506-1 ⁴ |
| | | | | Brass. Duplex ² | 1-770005-0 | 1-770248-0 | — | — | | |
| | | | | Phos. Brz. Pre-tin | 770005-3 | — | 770006-3 | 770249-3 | | |
| | | | | Phos. Brz. Duplex ² | 1-770005-1 | — | 1-770006-0 | 1-770249-0 | | |
| 12-10 [3.0-5.0] | .200 max. ³ 5.08 | 1.005 25.53 | .980 24.90 | Phos. Brz. Pre-tin | 770003-3 | 770246-3 | 770004-3 | 770247-3 | 567211-1 ⁶ 567211-2 ⁶ 567211-4 ⁶ | 69710-1 ⁵ |
| | | | | Phos. Brz. Duplex ² | 1-770003-0 | 1-770246-0 | 1-770004-0 | 1-770247-0 | | |

¹Gold Finish—Plated with .000030 [.000762] min. gold in mating area and inside wire barrel over .000050 [.00127] min. nickel underplate on entire contact.
²Duplex Finish—Plated with .000030 [.000762] min. gold in mating area and .000050 [.00127] min. tin in crimp area over .000050 [.00127] min. nickel underplate on entire contact.
³There is no insulation barrel on this contact. Insulation maximum diameter is limited by the housing. Use of strain relief is recommended with these contacts.
⁴Use Hand Tool No. 91508-1 for 20–18 AWG and No. 91506-1 for 16–14 AWG.
⁵Hand Tool No. 69710-1 uses die set No. 58380-1 for 12 AWG and No. 58380-2 for 10 AWG.
⁶HDM Applicator part number ending in -1 is used on AMPOMATOR CLS Machine with T or G Terminators, -2 is used on AMP-O-LECTRIC Model K Machine, -4 is used on AMP-O-LECTRIC Model G Machine. See pages 207-210 for further information.

Grounding Pin

(Mate first, break last, not for interrupting current)

Solid pin diameter .084 [2.13]
.100 [2.54] longer than standard pin
Stock thickness .012 [.304]

These contacts can be used in either Universal MATE-N-LOK II Plug or Cap housings only.

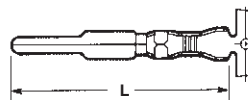

| Wire Size Range AWG [mm ²] | Ins. Dia. Range | L Dim. | Material & Finish | Contact Part Numbers | | HDM Applicator Part No. | Hand Tool Part No. |
|---|------------------------|----------------|----------------------------|----------------------|-------------|---|--|
| | | | | Strip Form | Loose Piece | | |
| 20-14 [.5-2.0] | .060-.130 1.52-3.30 | 1.105 25.53 | Brass. Pre-tin | 770193-1 | 770254-1 | 567213-1 ³ 567213-2 ³ 567213-4 ³ | 91500-1 |
| | | | Brass. Duplex ¹ | 1-770193-0 | 1-770254-0 | | |
| 20-14 [.5-2.0] | .130-.200 3.30-5.08 | 1.085 27.56 | Brass. Pre-tin | 770194-1 | 770255-1 | 567212-1 ³ 567212-2 ³ 567212-4 ³ | 91508-1 ² 91506-1 ² |
| | | | Brass. Duplex ¹ | 1-770194-0 | 1-770255-0 | | |

¹Duplex Finish—Plated with .000030 [.000762] min. gold in mating area and .000050 [.00127] min. tin in crimp area over .000050 [.00127] min. nickel underplate on entire contact.
²Use Hand Tool No. 91508-1 for 20–18 AWG and No. 91506-1 for 16–14 AWG.
³HDM Applicator part number ending in -1 is used on AMPOMATOR CLS Machine with T or G Terminators, -2 is used on AMP-O-LECTRIC Model K Machine, -4 is used on AMP-O-LECTRIC Model G Machine. See pages 207-210 for further information.



Latch Disengaging Tool
Part No. 58382-1
IS 408-9436



Contact Extraction Tool
(For extracting contacts crimped on 24 AWG or smaller wire)
Part No. 318851-1
IS 408-4371



Contact Insertion Tool
(For inserting contacts applied to small diameter wire)
Part No. 91002-1
IS 408-7347

Note: All part numbers are RoHS Compliant.

Universal MATE-N-LOK II Connectors (Continued)

Housing Kits
Free-Hanging or Panel Mount

.250 [6.35] Centerline spacing

Material—Nylon
Flammability Rating—UL 94V-0

Related Product Data

Product Specification

108-1090 Universal MATE-N-LOK II Connectors

Performance Characteristics—pages 189-190

Contacts—page 192

Panel Cutout Recommendations—page 195

Keying Plug—page 196

Strain Reliefs—page 196

Kit Components—page 195

Technical Documents—pages 189 and 205-206

Other Mating Connectors

Universal MATE-N-LOK Housings—page 175

Universal MATE-N-LOK Headers—pages 182-183 and 185

Universal MATE-N-LOK Test Connectors—page 185

2 Circuit, In-line



Plug Rear

Plug Front



Cap Front

Cap Rear

3, 4 and 5 Circuit, In-Line



Plug Rear

Plug Front

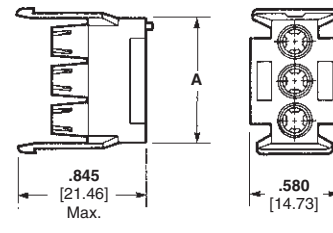

Cap Front

Cap Rear

| Number of Circuits | A Dim. | Kit Part Numbers (Includes Front and Rear) | |
|--------------------|----------------|--|----------|
| | | Plug | Cap |
| 2 | — | 770017-1 | 770024-1 |
| 3 | .800 20.32 | 770018-1 | 770025-1 |
| 4 | 1.050 26.67 | 770019-1 | 770026-1 |
| 5 | 1.300 33.02 | 770016-14 | — |

Notes:

1. Kits consist of a front and rear component.
2. Kit components can be purchased separately. Page 195.
3. Packaging: Bulk—250 each component per poly bag/box.
4. Mates with standard Universal MATE-N-LOK cap housing P/N 350810-1 and 640900-X or 640901-X Vertical headers.

Note: All part numbers are RoHS Compliant.

Universal MATE-N-LOK II Connectors (Continued)

Housing Kits
Free-Hanging or Panel Mount

.250 [6.35] Centerline spacing

Material — Nylon
Flammability Rating — UL 94V-0

Related Product Data

Product Specification

108-1090 Universal MATE-N-LOK II Connectors

Performance Characteristics — pages 189-190

Contacts — page 192

Panel Cutout Recommendations — page 195

Keying Plug — page 196

Strain Reliefs — page 196

Kit Components — page 195

Technical Documents — pages 189 and 205-206

Other Mating Connectors

Universal MATE-N-LOK Housings — page 176

Universal MATE-N-LOK Headers — pages 182-183 and 185

Universal MATE-N-LOK Test Connectors — page 185

6 Circuit, Matrix

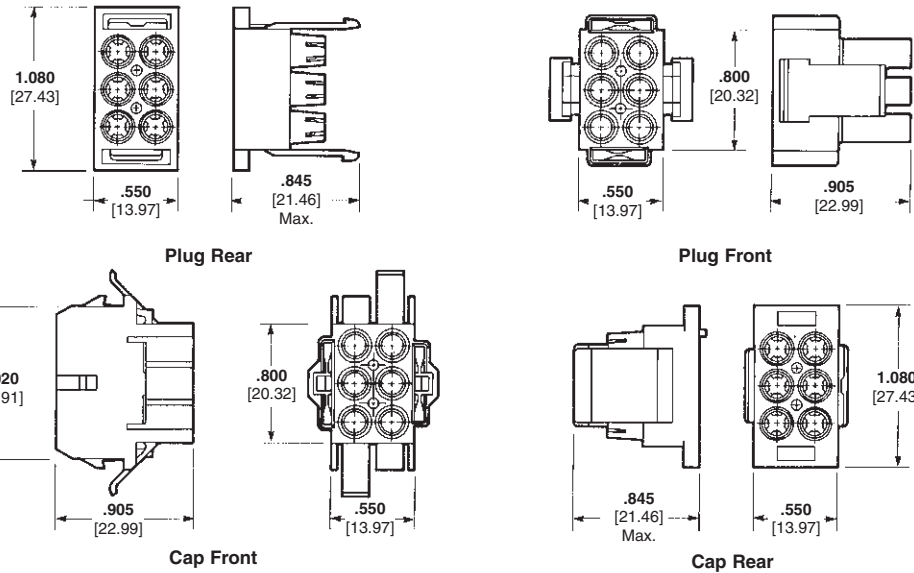

9, 12 and 15 Circuit, Matrix



| Number of Circuits | A Dim. | Kit Part Numbers (Includes Front and Rear) | |
|--------------------|----------------|--|----------|
| | | Plug | Cap |
| 6 | — | 770020-1 | 770027-1 |
| 9 | .800 20.32 | 770021-1 | 770028-1 |
| 12 | 1.050 26.67 | 770022-1 | 770029-1 |
| 15 | 1.300 33.02 | 770023-1 | 770030-1 |

Notes:

1. Kits consist of a front and rear component.
2. Kit components can be purchased separately. Page 195.
3. Packaging: Bulk — 250 each component per poly bag/box.

Note: All part numbers are RoHS Compliant.

Universal MATE-N-LOK II Connectors (Continued)

Housing Components
Free-Hanging or Panel Mount

.250 [6.35] Centerline spacing

Material — Nylon
Flammability Rating — UL 94V-0

Related Product Data

Product Specification
108-1090 Universal MATE-N-LOK II Connectors

Performance Characteristics — pages 189-190

Contacts — page 192

Illustrations and Dimensions — pages 193-194

Panel Cutout Recommendations — page 195

Keying Plug — page 196

Strain Reliefs — page 196

Technical Documents — pages 189 and 205-206

Other Mating Connectors

Universal MATE-N-LOK Connectors — page 176

Universal MATE-N-LOK Headers — pages 182-183 and 185

Universal MATE-N-LOK Test Connectors — page 185



| Number of Circuits | Kit Component Part Numbers | | | | | |
|--------------------|----------------------------|----------|----------|----------|----------|----------|
| | Plug | | | Cap | | |
| | Kit | Front | Rear | Kit | Front | Rear |
| 2 | 770017-1 | 770031-1 | 770032-1 | 770024-1 | 770045-1 | 770046-1 |
| 3 | 770018-1 | 770033-1 | 770034-1 | 770025-1 | 770047-1 | 770048-1 |
| 4 | 770019-1 | 770035-1 | 770036-1 | 770026-1 | 770049-1 | 770050-1 |
| 5 | 770016-1 | 770319-1 | 770320-1 | — | — | — |
| 6 | 770020-1 | 770037-1 | 770038-1 | 770027-1 | 770051-1 | 770052-1 |
| 9 | 770021-1 | 770039-1 | 770040-1 | 770028-1 | 770053-1 | 770054-1 |
| 12 | 770022-1 | 770041-1 | 770042-1 | 770029-1 | 770055-1 | 770056-1 |
| 15 | 770023-1 | 770043-1 | 770044-1 | 770030-1 | 770057-1 | 770058-1 |

Notes:

1. Kits consist of a front and rear component.
2. Kit components can be purchased separately.

Note: All part numbers are RoHS Compliant.

Recommended Cap Housing Panel Cutouts

View is from cap entry side

Refer to Application Specification 114-1043



| Number of Circuits | Dimensions | | | | |
|--------------------|----------------|---------------|--------------|----------------|--------------|
| | A | B | C | D | E |
| 2 | .565 14.35 | .340 8.63 | .095 2.41 | .530 13.46 | .250 6.35 |
| 3 | .815 20.70 | .340 8.63 | .095 2.41 | .530 13.46 | .250 6.35 |
| 4 | 1.065 27.05 | .340 8.63 | .095 2.41 | .530 13.46 | .250 6.35 |
| 6 | .565 14.35 | .480 12.19 | .275 6.99 | 1.030 26.16 | .250 6.35 |
| 9 | .815 20.70 | .480 12.19 | .275 6.99 | 1.030 26.16 | .250 6.35 |
| 12 | 1.065 27.05 | .480 12.19 | .275 6.99 | 1.030 26.16 | .350 8.89 |
| 15 | 1.315 33.40 | .480 12.19 | .275 6.99 | 1.030 26.16 | .350 8.89 |

Notes:

1. Recommended panel thickness — .030-.090 [.762-2.286]. Panel must be punched so that housing enters panel in same direction as the punch.
2. Optional — Do not remove this material when keying cap housing to panel.
3. Circuit #1 location when using panel keying with 6, 9, 12 and 15 circuit housings.
4. Circuit #1 location when using panel keying with 2, 3, and 4 circuit housings.

Universal MATE-N-LOK II Connectors (Continued)

Plug or Cap Housing Strain Reliefs
IS 408-3320

Material — Nylon
Flammability Rating — UL 94V-0

2, 3, 4, 5, 6, 9, 12 and 15 Circuit (Enclosed)



In-Line



Matrix

| Style | Number of Circuits | A Dim. | Insert Supplied | Single Wire Dia. Range | Wire Bundle Dia. Range | Strain Relief Part Numbers |
|---------|--------------------|----------------|-----------------|----------------------------|-----------------------------|----------------------------|
| In-Line | 2 | .960 24.38 | Yes | .040 – .190 1.02 – 4.83 | — | 640713-1 |
| | | | No | — | .200 – .350 5.08 – 8.89 | 640713-2 |
| | 3 | 1.140 28.96 | Yes | .040 – .190 1.02 – 4.83 | — | 640714-1 |
| | | | No | — | .200 – .350 5.08 – 8.89 | 641945-1 |
| | 4 | 1.340 34.04 | Yes | .040 – .190 1.02 – 4.83 | — | 641776-1 |
| | | | No | — | .200 – .350 5.08 – 8.89 | 641776-2 |
| Matrix | 5 | 1.530 38.86 | Yes | .040 – .190 1.02 – 4.83 | — | 643030-1 |
| | | | No | — | .200 – .350 5.08 – 8.89 | 643030-4 |
| | 6 | 1.030 26.16 | Yes | — | .120 – .650 3.05 – 16.51 | 640715-1 |
| | | | Yes | — | .120 – .650 3.05 – 16.51 | 640716-1 |
| | 9 | 1.030 26.16 | Yes | — | .120 – .650 3.05 – 16.51 | 640716-1 |
| | | | Yes | — | .150 – .750 3.81 – 19.05 | 640717-1 |
| | 12 | 1.280 32.51 | Yes | — | .150 – .750 3.81 – 19.05 | 640717-1 |
| | | | Yes | — | .200 – .850 5.08 – 21.59 | 640718-1 |
| | 15 | 1.530 38.86 | Yes | — | .200 – .850 5.08 – 21.59 | 640718-1 |

Notes:

1. Insert comes attached to strain relief. It can be used to provide additional adjustment for small wire bundles or discarded.
2. Insert to be positioned as shown by dotted lines.
3. Strain relief part number represents one-half of a strain relief. Two of a part number are required for one connector.

Keying Plug
IS 408-3200



Related Product Data

Housings — pages 193-194
Technical Documents — pages 189 and 205-206

Part Number
UL94V-0 Nylon material — **770377-1**

Note: All part numbers are RoHS Compliant.

Universal MATE-N-LOK Headers for UMNL II Connectors

PC Board Vertical Pin Headers

.250 [6.35] Centerline spacing

Material

Housing — Nylon

Flammability Rating — UL94V-0

Contacts — Phosphor bronze

Solder tail diameter .062 [1.57]

Related Product Data

Product Specification

108-1053 Universal MATE-N-LOK
PC Board Headers

Performance Characteristics —
pages 189-190

Recommended PC Board Hole Layout — page 199

Technical Documents — pages 189
and 205-206

Mating Connectors

Universal MATE-N-LOK II

Plug Housings — pages 193-194

Universal MATE-N-LOK

Plug Housings — page 175

**2, 3, 4 and 5
Circuit, In-Line**

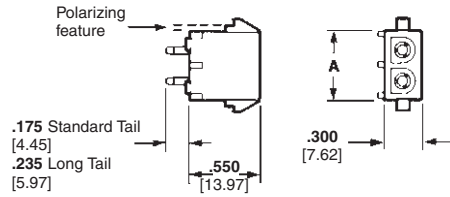

| Number of Circuits | A Dim. | Pin Finish | Pin Header Part Numbers | | | Mates with Plug Housing Part Number (Using Socket Contacts) | |
|--------------------|----------------|---------------------|----------------------------|--------------------------------------|------------------------|---|----------------------|
| | | | Standard Tail ² | Standard Tail Polarized ² | Long Tail ³ | Universal MATE-N-LOK II | Universal MATE-N-LOK |
| 2 | .550 13.97 | Pre-tin | 350786-1 | 641964-1 1-641964-14 | 350787-1 | 770017-1 | 350777-1 |
| | | Duplex ¹ | 350786-3 | 641964-3 | 350787-3 | | |
| 3 | .800 20.32 | Pre-tin | 350789-1 | 641966-1 1-641966-14 | 350790-1 | 770018-1 | 350766-1 |
| | | Duplex ¹ | 350789-3 | — | 350790-3 | | |
| 4 | 1.050 26.67 | Pre-tin | 350792-1 | 641968-1 | 350793-1 | 770019-1 | 350779-1 |
| | | Duplex ¹ | 350792-3 | — | 350793-3 | | |
| 5 | 1.300 33.02 | Pre-tin | 640900-1 | 643406-1 | — | 770016-1 | 350809-1 |
| | | Duplex ¹ | 640900-3 | — | — | | |

¹Duplex Finish — Plated with .000030 [.000762] min. gold in mating area, matte tin on solder tail end over .000050 [.00127] min. nickel underplate on entire contact.

²Use Standard Tail for .062 [1.57] thick PC Board.

³Use Long Tail for .125 [3.18] thick PC Board.

⁴Black in color.

**6, 9, 12 and 15
Circuit, Matrix**

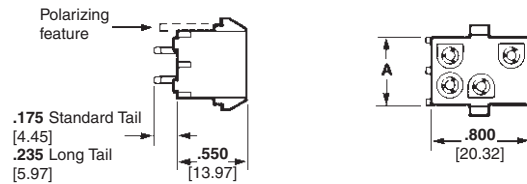

| Number of Circuits | A Dim. | Pin Finish | Pin Header Part Numbers | | | Mates with Plug Housing Part Number (Using Socket Contacts) | |
|--------------------|----------------|---------------------|----------------------------|--------------------------------------|------------------------|---|----------------------|
| | | | Standard Tail ² | Standard Tail Polarized ² | Long Tail ³ | Universal MATE-N-LOK II | Universal MATE-N-LOK |
| 6 | .550 13.97 | Pre-tin | 350711-1 | 641970-1 | 350732-1 | 770020-1 | 350715-1 |
| | | Duplex ¹ | 350711-4 | 641970-3 | 350732-4 | | |
| 9 | .800 20.32 | Pre-tin | 350712-1 | 641972-1 1-641972-14 | 350742-1 | 770021-1 | 350720-1 |
| | | Duplex ¹ | 350712-4 | 641972-3 | 350742-4 | | |
| 12 | 1.050 26.67 | Pre-tin | 350713-1 | 641974-1 1-641974-14 | 350737-1 | 770022-1 | 350735-1 |
| | | Duplex ¹ | 350713-4 | 641974-3 | 350737-4 | | |
| 15 | 1.300 33.02 | Pre-tin | 350714-1 | 641976-1 | 350738-1 | 770023-1 | 350736-1 |
| | | Duplex ¹ | 350714-4 | 641976-4 | 350738-4 | | |

¹Duplex Finish — Plated with .000030 [.000762] min. gold in mating area, matte tin on solder tail end over .000050 [.00127] min. nickel underplate on entire contact.

²Use Standard Tail for .062 [1.57] thick PC Board.

³Use Long Tail for .125 [3.18] thick PC Board.

⁴Black in color.

Note: All part numbers are RoHS Compliant.

Universal MATE-N-LOK Headers for UMNL II Connectors (Continued)

PC Board Vertical Socket Headers

.250 [6.35] Centerline spacing

Material

Housing — Nylon

Flammability Rating — UL94V-0

Contacts — Phosphor bronze

Solder tail diameter .062 [1.57]

Related Product Data

Product Specification

108-1053 Universal MATE-N-LOK
PC Board Headers

Performance Characteristics —
pages 189-190

Recommended PC Board Hole Layout — page 199

Technical Documents — pages 189
and 205-206

Mating Connectors

Universal MATE-N-LOK II

Plug Housings — pages 193-194

Universal MATE-N-LOK

Plug Housings — page 175

**2, 3, 4 and 5
Circuit, In-Line**



| Number of Circuits | A Dim. | Socket Finish | Socket Header Part Numbers | | | Mates with Plug Housing Part Number (Using Pin Contacts) | |
|--------------------|----------------|---------------------|----------------------------|--------------------------------------|------------------------|--|----------------------|
| | | | Standard Tail ² | Standard Tail Polarized ² | Long Tail ³ | Universal MATE-N-LOK II | Universal MATE-N-LOK |
| 2 | .550 13.97 | Pre-tin | 350824-1 | 643412-1 | 350831-1 | 770017-1 | 350777-1 |
| | | Duplex ¹ | 350824-4 | 643412-3 | — | | |
| 3 | .800 20.32 | Pre-tin | 350825-1 | 643414-1 | 350832-1 | 770018-1 | 350766-1 |
| | | Duplex ¹ | 350825-4 | 643414-3 | 350832-4 | | |
| 4 | 1.050 26.67 | Pre-tin | 350826-1 | 643416-1 | 350833-1 | 770019-1 | 350779-1 |
| | | Duplex ¹ | 350826-4 | — | 350833-4 | | |
| 5 | 1.300 33.02 | Pre-tin | 640901-1 | — | — | 770016-1 | 350809-1 |
| | | Duplex ¹ | 640901-3 | — | — | | |

¹Duplex Finish — Plated with .000030 [.000762] min. gold in mating area, matte tin on solder tail end over .000050 [.00127] min. nickel underplate on entire contact.

²Use Standard Tail for .062 [1.57] thick PC Board.

³Use Long Tail for .125 [3.18] thick PC Board.

**6, 9, 12 and 15
Circuit, Matrix**

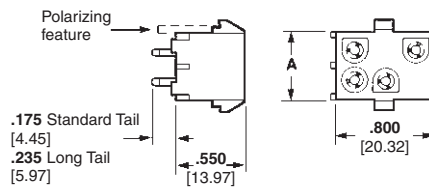

| Number of Circuits | A Dim. | Socket Finish | Socket Header Part Numbers | | | Mates with Plug Housing Part Number (Using Pin Contacts) | |
|--------------------|----------------|---------------------|----------------------------|--------------------------------------|------------------------|--|----------------------|
| | | | Standard Tail ² | Standard Tail Polarized ² | Long Tail ³ | Universal MATE-N-LOK II | Universal MATE-N-LOK |
| 6 | .550 13.97 | Pre-tin | 350827-1 | 643424-1 | 350834-1 | 770020-1 | 350715-1 |
| | | Duplex ¹ | 350827-4 | 643424-3 | 350834-4 | | |
| 9 | .800 20.32 | Pre-tin | 350828-1 | 643426-1 | 350835-1 | 770021-1 | 350720-1 |
| | | Duplex ¹ | 350828-4 | 643426-3 | 350835-4 | | |
| 12 | 1.050 26.67 | Pre-tin | 350829-1 | 643428-1 | 350836-1 | 770022-1 | 350735-1 |
| | | Duplex ¹ | 350829-4 | — | 350836-4 | | |
| 15 | 1.300 33.02 | Pre-tin | 350830-1 | 643430-1 | 350837-1 | 770023-1 | 350736-1 |
| | | Duplex ¹ | 350830-4 | — | 350837-4 | | |

¹Duplex Finish — Plated with .000030 [.000762] min. gold in mating area, matte tin on solder tail end over .000050 [.00127] min. nickel underplate on entire contact.

²Use Standard Tail for .062 [1.57] thick PC Board.

³Use Long Tail for .125 [3.18] thick PC Board.

Note: All part numbers are RoHS Compliant.

Standard Density

Universal MATE-N-LOK Headers
.250 [6.35] Centerline

Universal MATE-N-LOK Headers for UMNL II Connectors (Continued)

Recommended PC Board Hole Layouts for Pin and Socket Vertical Headers

Related Product Data
Vertical Headers — pages 197-198

2, 3, 4 and 5 Circuit, In-Line



6, 9, 12 and 15 Circuit, Matrix



Note: Polarizing hole .070 [1.78] Dia. required for polarized headers only.

PC Board Vertical Pin Headers with ACTION PIN Contacts

Material and Finish
Housing — PBT, black
Flammability Rating — UL94V-0
Contacts — Copper alloy, plated with tin over nickel on entire contact

Related Product Data
Performance Characteristics — pages 189-190
Technical Documents — pages 189 and 205-206

Product Specification
108-5222 ACTION PIN Universal MATE-N-LOK Header Assembly

Mating Connectors
Universal MATE-N-LOK II Plug Housings — pages 193-194
Universal MATE-N-LOK Plug Housings — page 175



| Number of Circuits | A Dim. | Part Number | Mates with Plug Housing Part Number (Using Socket Contacts) | |
|--------------------|----------------|-------------|---|----------------------|
| | | | Universal MATE-N-LOK II | Universal MATE-N-LOK |
| 2 | .750 19.05 | 173924-1* | 770017-1 | 350777-1 |
| 3 | 1.000 25.40 | 173925-1* | 770018-1 | 350766-1 |
| 4 | 1.250 31.75 | 173926-1* | 770019-1 | 350779-1 |

*Install in PC Board with arbor tool.

Note: All part numbers are RoHS Compliant.



Recommended PC Board Hole Layout PC Board Hole Dimensions

Universal MATE-N-LOK Headers for UMNL II Connectors (Continued)

PC Board Right-Angle Pin and Socket Headers

.250 [6.35] Centerline spacing

Material

Housing — Nylon

Flammability Rating — UL 94V-0

Contacts — Phosphor bronze

Solder tail width .052 [1.32]

Related Product Data

Product Specification

108-1053 Universal MATE-N-LOK
PC Board Headers

Performance Characteristics —
pages 189-190

Technical Documents — pages 189
and 205-206

Mating Connectors

Universal MATE-N-LOK II

Plug Housings — pages 193-194

Universal MATE-N-LOK

Plug Housings — page 175

2, 3, 4 and 5 Circuit, In-line

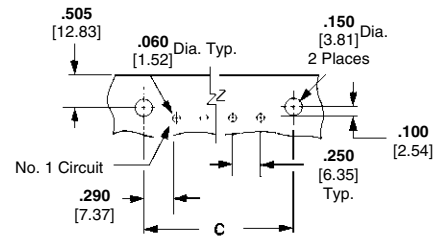
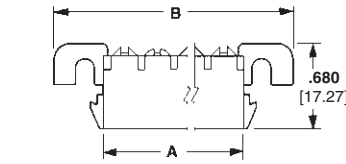

Use 6-32 UNC Pan Head Screw
3/8 [9.53] long for mounting
(Not Supplied)

Recommended PC Board Hole Layout
.062 [1.57] Board Thickness

| Number of Circuits | Dimensions | | | Contact Finish | Part Numbers | | | |
|--------------------|----------------|----------------|----------------|---------------------|--------------------|------------|-------------------------|----------------------|
| | A | B | C | | Right-Angle Header | | Mates with Plug Housing | |
| | | | | | Pin | Socket | Universal MATE-N-LOK II | Universal MATE-N-LOK |
| 2 | .550 13.97 | 1.245 31.62 | .830 21.08 | Pre-tin | 1-350942-0 | 643226-1 | 770017-1 | 350777-1 |
| | | | | Duplex ¹ | 3-350942-0 | — | | |
| 3 | .800 20.32 | 1.495 37.97 | 1.080 27.43 | Pre-tin | 1-350943-0 | 643228-1 | 770018-1 | 350766-1 |
| | | | | Duplex ¹ | 3-350943-0 | 3-643228-0 | | |
| 4 | 1.050 26.67 | 1.745 44.32 | 1.330 33.78 | Pre-tin | 1-350944-0 | 643230-1 | 770019-1 | 350779-1 |
| | | | | Duplex ¹ | 3-350944-0 | 3-643230-0 | | |
| 5 | 1.300 33.02 | 1.995 50.67 | 1.580 40.13 | Pre-tin | 1-350945-0 | 643232-1 | 770016-1 | 350809-1 |
| | | | | Duplex ¹ | 3-350945-0 | 3-643232-0 | | |

¹Duplex Finish — Plated with .000030 [0.000762] min. gold in mating area, matte tin on solder tail end over .000050 [0.00127] min. nickel underplate on entire contact.

Note: All part numbers are RoHS Compliant.

Universal MATE-N-LOK Headers for UMNL II Connectors (Continued)

High Current Contacts

The Louvertac bands have the versatility of being designed into contact dimensions used in existing AMP connectors.

Universal MATE-N-LOK II High Current contacts have been designed to fit into an existing Universal MATE-N-LOK II housing. An initial T-Rise test of a fully energized 4 circuit connector with 10 gage wires has shown a 31 amp capability per line with a 30° T-rise.

Cable-to-Cable

Material

Body — Copper Alloy

Louvertac Band — Beryllium Copper

Finish — Silver

Contact Extraction Tool No. 318851-1

Latch Disengaging Tool No. 58382-1

■ **Recognized under the Component Program of Underwriters Laboratories Inc., File No. E28476**



■ **Certified by Canadian Standards Association, File No. LR7189**



■ **Passed test by VDE under their Registration Number 3980/Continuous Surveillance**



Design Objective — 108-1583

Application Specification — 114-16021

Cable-to-Right-Angle Board

Material

Housing — UL 94V-0 Nylon

Contact Body — Copper Alloy

Louvertac Band — Beryllium Copper

Finish — Silver

■ **Recognized under the Component Program of Underwriters Laboratories Inc., File No. E28476**



■ **Certified by Canadian Standards Association, File No. LR7189**



■ **Passed test by VDE under their Registration Number 3980/Continuous Surveillance**



Design Objective — 108-1594



Contacts

| Wire Size AWG | Contact Part Numbers | | Crimp Tools |
|------------------|----------------------|----------|--|
| | Pin | Socket | |
| 10 | 193796-1 | 193797-1 | Daniels Hand Tool #M310 or AMP P/N 356114-1 Positioner #TP1013 or AMP P/N 356337-1 |
| 12-14 | 193841-1 | 193842-1 | |

Note: High Current contacts are **not** intermateable with any other Universal MATE-N-LOK contact.



Connector Housings

| No. of Circuits | Kit Part Numbers | |
|--------------------|------------------|----------|
| | Plug | Cap |
| 2 | 770017-1 | 770024-1 |
| 3 | 770018-1 | 770025-1 |
| 4 | 770019-1 | 770026-1 |
| 5 | 770016-1 | — |
| 6 | 770020-1 | 770027-1 |
| 9 | 770021-1 | 770028-1 |
| 12 | 770022-1 | 770029-1 |
| 15 | 770023-1 | 770030-1 |



Connector Housings

| No. of Circuits | Part Numbers | |
|--------------------|---------------|-------------------------|
| | Socket Header | Mates with Plug Housing |
| 2 | 193839-1 | 770017-1 |
| 3 | 193839-2 | 770018-1 |
| 4 | 193839-3 | 770019-1 |
| 5 | 193839-4 | 770016-1 |

Notes: 1. High Current contacts with Louvertac bands are **not** intermateable with any other contact.
2. Additional information on connectors is available in AMP High Current Products Catalog 65141.
3. Additional information on contacts is available in AMP Precision Pin and Socket Contacts Catalog 65910.

Note: All part numbers are RoHS Compliant.

Universal MATE-N-LOK Headers for UMNL II Connectors (Continued)

High Current Vertical Pin Headers

High Current Universal MATE-N-LOK II Vertical Pin Headers are designed to accept Universal MATE-N-LOK II Plugs with High Current Socket contacts. All housings are polarized in order to allow proper circuit board placement. Eight versions are available from 2 circuit to 15 circuits.

Material

Housing — UL 94V-0 Nylon

Contacts — Copper Alloy

Finish — Silver

■ **Recognized under the Component Program of Underwriters Laboratories Inc., File No. E28476**



■ **Certified by Canadian Standards Association, File No. LR7189**



■ **Passed test by VDE under their Registration Number 3980/Continuous Surveillance**



Design Objective — 108-1594



2 Circuit
Part No. 194009-1

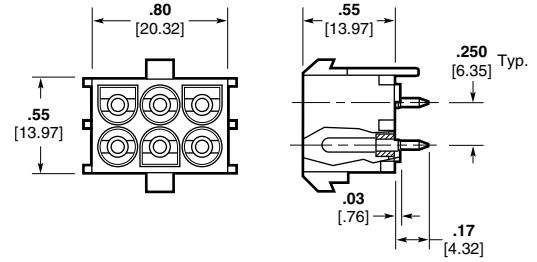

6 Circuit
Part No. 194002-1



3 Circuit
Part No. 194017-1

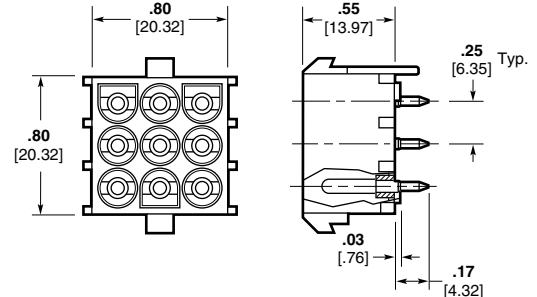

9 Circuit
Part No. 194012-1



4 Circuit
Part No. 194010-1

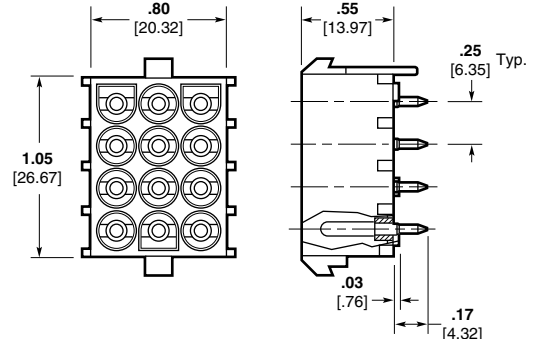

12 Circuit
Part No. 194014-1



5 Circuit
Part No. 194018-1

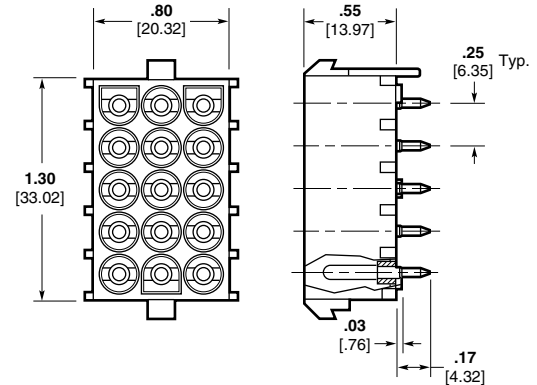

15 Circuit
Part No. 194013-1

Notes: 1. High Current contacts with Louvertac bands are **not** intermateable with any other contact.
2. Additional information on connectors is available in AMP High Current Products Catalog 65141.

Standard Density

Universal MATE-N-LOK Headers
.250 [6.35] Centerline

.156 MATE-N-LOK Connectors

Product Facts

- Positive polarized nylon housings
- Panel mount or free-hanging
- Numbered cavities for easy circuit identification
- Removable, crimp snap-in contacts
- Contacts accept 20-10 AWG wire sizes
- Pin contacts are used in cap housings, socket contacts are used in plug housings
- Not for interrupting current
- Recognized under the Component Program of Underwriters Laboratories Inc., File No. E28476 
- Certified by Canadian Standards Association File No. LR7189



Pin
Used in Caps



Socket
Used in Plugs

Contacts

Pin diameter .156 [3.96]

Material and Finish

Contacts—
Brass, Pre-tin plated
Stock thickness .018 [.457]

| Wire Size Range AWG [mm ²] | Ins. Dia. Range | Contact Part Number | | | | HDM ¹ Applicator Part No. | Hand Tool Part No. |
|---|-----------------|---------------------|-------------|------------|-------------|--------------------------------------|--------------------|
| | | Pin | | Socket | | | |
| | | Strip Form | Loose Piece | Strip Form | Loose Piece | | |
| 20-14 [.5-2.0] | .125 max. | 61086-1 | 61251-1 | 61085-1 | 61250-1 | 466462-1 466462-2 466462-3 | 58631-1 |
| 12-10 [3.0-6.0] | .185 max. | 61234-1 | 61253-1 | 61233-1 | 61252-1 | 687765-2 687765-3 | 58632-1 |

¹To be used with appropriate application machine. See pages 201-204 for further information.

Note: All part numbers are RoHS Compliant.



Insertion Tool
Part No. 91002-1
(IS 408-7347)

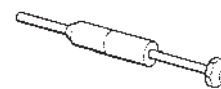

Extraction Tool
Part No. 691458-1 (Pins)
Part No. 691458-2 (Sockets)
(IS 408-4322)

.156 MATE-N-LOK Connectors (Continued)

Housings
Free-Hanging or Panel Mount

Related Product Data

Contacts—page 203

Product Specification
108-8002

Application Specification
114-1109

Material

Housings—
Nylon, Natural Color
Flammability Rating—UL94V-2



Pin Housing (Cap)
Free-Hanging
Part Number 794117-1



Pin Housing (Cap)
Panel Mount
Part Number 794118-1



Socket Housing (Plug)
Part Number 794116-1



Panel Mount Cutout

Note: Panel must be punched in the same direction as the housing will be inserted.

| Number of Circuits | A Dim. | Plug | Cap | |
|--------------------|---------------|----------|--------------|-------------|
| | | | Free-Hanging | Panel Mount |
| 3 | .048 1.210 | 794412-1 | 794413-1 | — |
| 4 | .063 1.590 | 794116-1 | 794117-1 | 794118-1 |

Note: All part numbers are RoHS Compliant.

Technical Documents

Related Product Data

Connectors

- 2.5 mm Signal Double Lock (SDL)**—
pages 9-16
- Micro MATE-N-LOK 3 mm**—
pages 17-47
- Grace Inertia Connectors (GIC) 3.5**—pages 49-52
- .062 Commercial Pin and Socket**—pages 53-57
- Power Double Lock (PDL)**—
pages 59-81
- Mini Universal MATE-N-LOK**—
pages 83-94
- Mini Universal MATE-N-LOK 2**—
pages 99-107
- (MR) Miniature Rectangular**—
pages 109-118
- VAL-U-LOK Connector System**—
pages 119-124
- AMP-DUAC**—pages 125-133
- 5.0 mm Power Key Connectors (PKC)**—pages 135-141
- .093 Commercial Pin and Socket**—pages 143-149
- Commercial MATE-N-LOK**—
pages 151-162
- .140 MATE-N-LOK**—pages 165-167
- Universal MATE-N-LOK**—
pages 169-188
- Universal MATE-N-LOK II**—
pages 189-195
- .156 MATE-N-LOK**—pages 203-204

Various technical documents are available for your use:

Product Specifications describe technical performance characteristics and verification tests.

They are intended for the Design, Component and Quality Engineer.

- | | |
|------------|--|
| 108-1000 | Commercial MATE-N-LOK Connectors |
| 108-1022 | (MR) Miniature Rectangular Connectors |
| 108-1031 | Universal MATE-N-LOK Connectors |
| 108-1031-1 | Splash Proof Seal, Universal MATE-N-LOK Connectors |
| 108-1032 | .140 Diameter MATE-N-LOK Pin and Socket Connectors |
| 108-1037 | .062 Commercial Pin and Socket Connectors |
| 108-1037-1 | .062 Commercial Pin and Socket Contacts |
| 108-1038 | .093 Commercial Pin and Socket Connector |
| 108-1053 | Universal MATE-N-LOK Printed Circuit Board Headers |
| 108-1077 | Commercial MATE-N-LOK Printed Circuit Board Headers |
| 108-1078 | (MR) Miniature Rectangular Printed Circuit Board Headers |
| 108-1090 | Universal MATE-N-LOK II Connectors |
| 108-1542 | Mini-Universal MATE-N-LOK Connectors |
| 108-1542-2 | Splash Proof Seals for Mini-Universal MATE-N-LOK Connectors |
| 108-1543 | Mini-Universal MATE-N-LOK Headers |
| 108-1594 | Universal MATE-N-LOK Headers with High Current Contacts |
| 108-1693 | Mini-Universal MATE-N-LOK II Connectors |
| 108-1694 | Mini-Universal MATE-N-LOK II Headers |
| 108-1699 | AMP-DUAC Headers |
| 108-1836 | Micro MATE-N-LOK 3 mm Connectors |
| 108-2069 | Universal MATE-N-LOK Circular Connector |
| 108-5138 | Mini-Universal MATE-N-LOK Connectors (UL 94V-0) |
| 108-5151 | Mini-Universal MATE-N-LOK Connectors (UL 94V-2) |
| 108-5155 | Commercial MATE-N-LOK Pin Header Assembly |
| 108-5222 | Universal MATE-N-LOK Headers with ACTION PIN Contacts |
| 108-5410 | Power Double Lock (PDL) Connectors |
| 108-5439 | Power Double Lock (PDL) Connectors (SMT) |
| 108-5459 | 2.5 mm Signal Double Lock (SDL) Connectors |
| 108-5699 | 5.0 mm Power Key Connectors (PKC) |
| 108-5810 | Grace Inertia Connectors (GIC) 3.5 |
| 108-8002 | .156 Diameter MATE-N-LOK Connectors |
| 108-19099 | AMP-DUAC Receptacles |
| 108-49000 | Commercial MATE-N-LOK IDC Insulation Displacement Connectors |

Application Specifications describe requirements for using the product in its intended application and/or crimping information. They are intended for the Packaging and Design Engineer and the Machine Setup Person.

- | | |
|-----------|---|
| 114-1007 | .140 Diameter MATE-N-LOK Contacts |
| 114-1010 | Universal MATE-N-LOK Connectors |
| 114-1012 | Commercial MATE-N-LOK Contacts |
| 114-1013 | .062 Commercial Pin and Socket Connectors |
| 114-1014 | (MR) Miniature Rectangular Contacts |
| 114-1043 | Universal MATE-N-LOK II Connectors (housings, contacts and strain reliefs) |
| 114-1109 | .156 Diameter MATE-N-LOK Connectors |
| 114-1111 | Mini-Universal MATE-N-LOK 2 Connectors |
| 114-5175 | Power Double Lock (PDL) Connectors |
| 114-5203 | 2.5 mm Signal Double Lock (SDL) Connectors |
| 114-5292 | 5.0 mm Power Key Connectors (PKC) |
| 114-5306 | Grace Inertia Connectors (GIC) 3.5 |
| 114-6067 | AMP-DUAC Crimping Contacts |
| 114-13000 | Micro MATE-N-LOK 3 mm Connectors |

Technical Documents (Continued)

Application Specifications (Continued)

| | |
|-----------|--|
| 114-13089 | Mini-Universal MATE-N-LOK Sealed Connectors |
| 114-16017 | Mini-Universal MATE-N-LOK Connectors |
| 114-19048 | AMP-DUAC Receptacles (Use of) |
| 114-49000 | .093 Commercial Pin and Socket Connectors |
| 114-49001 | Commercial MATE-N-LOK IDC Insulation Displacement Connectors |

Instruction Sheets provide instructions for assembling or applying the product. They are intended for the Manufacturing Assembler or Operator.

| | |
|-----------|--|
| 408-3186 | Terminating Head (PN 231894-1) (Commercial MATE-N-LOK IDC Connector) |
| 408-3200 | Universal MATE-N-LOK II Connectors (Housings, Contacts and Accessories) |
| 408-3231 | (MR) Miniature Rectangular Connectors (Pin Housing, Socket Housing, Contacts, and Accessories) |
| 408-3234 | Mini-Universal MATE-N-LOK Connectors |
| 408-3320 | Universal MATE-N-LOK Strain Relief Assembly and Keying Plug |
| 408-3392 | Universal MATE-N-LOK Splash Proof Seals |
| 408-3393 | Mini-Universal MATE-N-LOK 2 Connectors |
| 408-4118 | Contact Extraction Tool (PN 189727-1) |
| 408-4322 | Contact Extraction Tools [PN 691458-1 (Pins) and 691458-2 (Sockets)] |
| 408-4370 | Contact Extraction Tool (PN 318831-1) |
| 408-4371 | Contact Extraction Tool (PN 318851-1) |
| 408-4375 | Contact Extraction Tool (PN 318837-1) |
| 408-4378 | Extraction Tool (PN 318845-1) |
| 408-6790 | Hand Tool Handle (PN 58074-1) |
| 408-7158 | Contact Extraction Tools [PN 1-305183-1 (Pins) and 1-305183-2 (Sockets)] |
| 408-7166 | Commercial MATE-N-LOK Panel Mount Connector |
| 408-7200 | Commercial MATE-N-LOK Free-Hanging Connector |
| 408-7201 | Commercial MATE-N-LOK Detent Engagement Connectors, 2 and 3 circuit |
| 408-7209 | Commercial MATE-N-LOK Commoning Tabs |
| 408-7211 | Pin and Socket Extraction Tool (PN 465644-1) |
| 408-7215 | Commercial MATE-N-LOK Single Circuit Connector |
| 408-7300 | MATE-N-LOK Contact and Housing Selection Charts |
| 408-7347 | Contact Insertion Tool (PN 91002-1) |
| 408-7582 | Commercial MATE-N-LOK Keying Plug |
| 408-7714 | Universal MATE-N-LOK Connectors |
| 408-7763 | Power Unit (PN 91112-2) |
| 408-7984 | Contact Insertion Tool (PN 455830-1) |
| 408-9330 | Head (PN 231920-2) (Used with Arbor Tool PN 91085-2) |
| 408-9436 | Latch Disengaging Tool (PN 58382-1) |
| 408-9570 | Contact Extraction Tool (PN 455822-2) |
| 408-10003 | Contact Retention Test Tool (PN 1586700-1) |
| 408-10017 | Universal MATE-N-LOK Sealed Bulkhead Connectors |
| 411-5105 | Mini-Universal MATE-N-LOK Connectors |
| 411-5638 | Power Double Lock (PDL) Connectors |

Application Tooling

Semiautomatic Machines

AMP-O-LECTRIC Model "G" Terminating Machines, 354500-1, -9, -11



Semiautomatic bench machines for crimping reeled terminals and contacts, featuring a quiet and reliable direct motor drive, microprocessor controls for ease of setup and operation, and guarding and lighting designed for operator convenience and safety. All models are equipped with either manual or automatic precision adjustment of crimp height. Machine-mounted sensors are available for crimp quality monitoring using conventional miniature-style applicators.

Specifications
Width—18.7-25.3 [475-643] depending on applicator type
Depth—21.5-28.1 [546-713] depending on applicator type
Height—20 [508]
Weight—240 lb [110 kg]
Electrical—120 or 220 VAC, 50 or 60 Hz
Air—90-110 psi [6.21-7.59 bar], 6 scfm [0.00282 m³/s] when required with air-feed applicators
Wire Range—26-10 AWG [0.12-6 mm²] solid or stranded, depending on product applied
 For more information, request Catalog **65828**, Catalog **82275 (Crimp Quality Monitor (CQM))**.

AMP-O-MATIC Stripper-Crimper Machine, 854040-3, -4



Semiautomatic bench crimping machines that also strip the wire, and are therefore used for terminating jacketed cable. Feature manual precision adjustment of crimp height, keyed strip blades for faster, more accurate setups, and an efficient scrap removal system. All adjustments can be made from the front of the machines without special tools. Available with crimp quality monitoring.

Specifications
Width—14 [355]
Depth—18 [457]
Height—33 [838] without reel
Weight—150 lb [68 kg]
Electrical—120 VAC, 50 or 60 Hz, .5 A
Air—80-100 psi [5.52-6.90 bar], 3.5 scfm [0.00165 m³/s]
Wire Range—32-14 AWG [0.03-2 mm²]
 For more information, request Catalog **65004**.

AMP 3K/40 and AMP 5K/40 Terminators



As value oriented terminators, the AMP 3K/40 and AMP 5K/40 are designed for customers that require the increased output and quality of a semi-automatic machine at a competitive price. By incorporating the most commonly requested features as standard and offering a long list of optional equipment, these terminators offer flexibility to meet the specific needs of various applications at the lowest possible cost.

Optional Stripping Module for the AMP 3K/40, AMP 5K/40 and AMP-O-LECTRIC Model G Terminators



The combination of the Stripping Module with the AMP-O-LECTRIC Model G Terminator or the AMP 3K/40, 5K/40 provides an economical, proficient method of stripping wire and crimping terminals on the same machine. Wires are stripped moments before crimping, meaning there is virtually no chance of damaging wire conductors during handling or storage. Once the wire is fed into the start sensor the Stripping Module does the rest, improving placement accuracy.

For more information, request Catalog **1309085**.

Crimp Quality Monitor



This system measures the crimp height of each termination as it is made. It also evaluates the quality of each crimp. If a crimp is questionable, the monitor alerts the operator with both visual and audible alarms. It also features ports for printing and networking. For use with AMP-O-LECTRIC Model "G" and AMP-O-MATIC Stripper-

Crimper Machines, the monitor is mounted to the machine. For use with AMPOMATOR CLS IV+ Machines, it is integrated into the machine's operating system, with the displays appearing on the machine's touch screen.

For more information, request Catalog **82275**.

Note: This listing is for reference purposes only. To obtain part numbers for specific applications call Technical Support.

Application Tooling (Continued)

Application Tooling

Automatic Machines

**AMPOMATOR System III
Leadmaker**



The AMPOMATOR System III Leadmaker is designed for the demands of low-volume/high-mix manufacturing and precision quality. This leadmaker combines the best wire processing capabilities with

new technologies in terminal feeding and machine set-up found in the System III Applicator to offer significant advantages for higher throughput and efficiencies. Request Catalog 1654956-5.

**AMPOMATOR CLS IV+
Lead-Making Machines,
356500-1, -2**

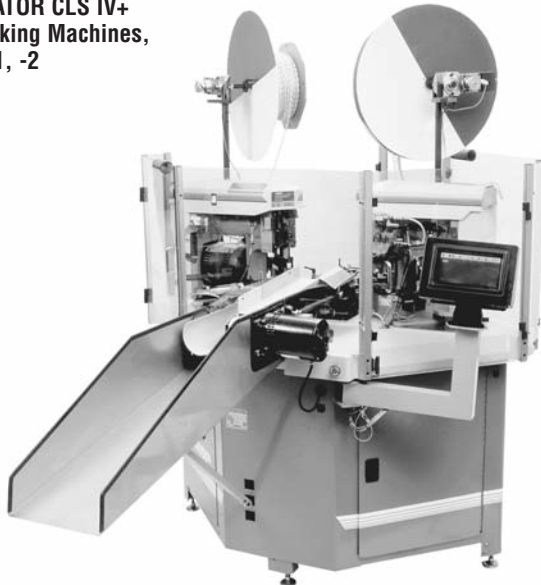

System III Applicator



The System III Applicator introduces several new technologies into the applicator including a precision servo-electric motorized feeding system, a built-in data module for storing terminal crimp and

set-up information, a precision fit round ram, and a newly designed terminal depressor. It still utilizes the proven quality of the HD-M crimper and anvil tooling.

Fully-automatic machines that measure, cut, strip and terminate single leads. Microprocessor-controlled, and programmed and operated using an easy-to-follow, menu-driven touchscreen. Features include direct-drive terminating units with precision crimp height adjustment, fully programmable setups, wire runout and splice detection, and motorized pre-feed with wire straightener. Crimp quality monitoring is also available.

Specifications

- Width**—159 [4 039]
 - Depth**—68 [1 730]
 - Height**—90 [2 285] min., with 24 [610] dia. reel
 - Weight**—2 000 lb [907 kg]
 - Electrical**—220 VAC, 50 or 60 Hz, 1 Ø, 20 A with neutral and ground
 - Air**—90 psi [6.21 bar], 15 scfm [0.00708 m³/s] sustained
 - Wire Range**—26-10 AWG [0.12-6 mm²] stranded, 26-16 AWG [0.12-1.4 mm²] solid
 - Lead Lengths**—3-90 [76.2-2 286], 90-1 000 [2 286-25 400] with long lead conveyors
- For more information, request Catalog 124324.

**EDGE Electronic Applicator
Counter**



The new, versatile EDGE applicator counter tracks wearable tool usage for the most effective maintenance planning. The completely electronic counter, with clear LCD display, indicates cycles since installation. By performing maintenance at measured intervals with pre-set

limits, operators avoid break-downs and rejects caused by tool wear or mis-adjustment. For more information, request Catalog 1773385.

Application Tooling (Continued)

Applicator Styles

End- and Side-Feed Heavy-Duty Miniature (HDM) Applicators



- Handle a wide variety of products
- Used with both semi- and fully-automatic machines
- Quickly interchangeable to run different products
- Easily repaired
- Simple dial-in settings to handle similar products and various wire sizes

Stripper-Crimper (SCA) Applicators



- For use with AMP-O-MATIC Stripper-Crimper Machines
- Terminate a wide variety of open-barrel products
- Quickly interchangeable to run different products
- Easily repaired
- Simple dial-in settings to handle similar products and various wire sizes
- CQM applicators are available

Crimp Quality Monitor (CQM) Applicators



- Same basic features as regular HDM and SCA applicators
- Recommended for use with machines featuring manual or automatic precision-adjust
- Use two built-in sensors to provide the Crimp Quality Monitor with data to measure crimp height, and evaluate the quality of each crimp

Applicator and Hand Tool Selection Guide

Related Product Data

Contacts

- 2.5 mm Signal Double Lock (SDL)—page 12
- Micro MATE-N-LOK 3 mm—page 22
- Grace Inertia Connectors (GIC) 3.5—page 50
- .062 Commercial Pin and Socket—page 55
- Power Double Lock (PDL)—page 61
- Mini Universal MATE-N-LOK—page 84
- Mini Universal MATE-N-LOK 2—pages 100-101
- (MR) Miniature Rectangular—page 112
- VAL-U-LOK Connector System—page 120
- AMP-DUAC—pages 126-127
- 5.0 mm Power Key Connectors (PKC)—page 137
- .093 Commercial Pin and Socket—page 145
- Commercial MATE-N-LOK—pages 155-156
- .140 MATE-N-LOK—page 166
- Universal MATE-N-LOK—pages 172-173
- Universal MATE-N-LOK II—page 192
- .156 MATE-N-LOK—page 203

| Density | Product Line | Applicators | | | Hand Tools | |
|-------------------------|------------------------------------|-------------|---|---|------------|---|
| | | A | B | C | D | E |
| High | 2.5 mm Signal Double Lock (SDL) | * | * | * | X | - |
| | Micro MATE-N-LOK 3 mm | X | X | X | X | - |
| | Grace Inertia Connectors (GIC) 3.5 | * | * | * | X | - |
| | .062 Commercial Pin and Socket | X | X | X | - | X |
| | Power Double Lock (PDL) | * | * | * | X | - |
| | Mini-Universal MATE-N-LOK | X | X | X | X | X |
| | Sealed Mini-Universal MATE-N-LOK | X | X | X | X | - |
| | Mini-Universal MATE-N-LOK 2 | X | X | X | X | X |
| | (MR) Miniature Rectangular | X | X | X | X | - |
| | VAL-U-LOK Connector System | X | - | - | - | X |
| | AMP-DUAC | X | X | - | X | - |
| Standard | 5.0 mm Power Key Connectors (PKC) | * | * | * | X | - |
| | .093 Commercial Pin and Socket | X | X | X | - | X |
| | Commercial MATE-N-LOK | X | X | X | X | X |
| | .140 MATE-N-LOK | X | X | X | X | - |
| | Universal MATE-N-LOK | X | X | X | X | X |
| Universal MATE-N-LOK II | X | X | X | X | X | |
| .156 MATE-N-LOK | X | - | - | X | - | |

A—Heavy Duty Miniature (HDM) Applicators
 B—Stripper-Crimper Applicators (SCA)
 C—Crimp Quality Monitor (CQM) Applicators
 D—CERTI-CRIMP Hand Tool
 E—PRO-CRIMPER III Commercial Hand Tool

* Contact the Tooling Assistance Center (TAC) at 1-800-722-1111 for Applicator Part Numbers.

Mechanical Hand Tools

CERTI-CRIMP II Straight Action Hand Tools (SAHT) 91501-1, 91502-1



Premium grade hand tools. Feature ratchet control to provide complete crimp cycle. Die sets close in a straight line. Include a contact locator and wire stop, plus an insulation crimp

adjustment lever, when applicable. Approximate weight 1.3 lb [0.59 kg] For more information, request Catalog **65780**.

Note: This listing is for reference purposes only. To obtain part numbers for specific applications call Technical Support.

Application Tooling (Continued)

Hand Tools

Related Product Data

Contacts

- 2.5 mm Signal Double Lock (SDL)**—page 12
- Micro MATE-N-LOK 3 mm**—page 22
- Grace Inertia Connectors (GIC) 3.5**—page 50
- .062 Commercial Pin and Socket**—page 55
- Power Double Lock (PDL)**—page 61
- Mini Universal MATE-N-LOK**—page 86
- Mini Universal MATE-N-LOK 2**—pages 100-101
- (MR) Miniature Rectangular**—page 112
- VAL-U-LOK Connector System**—page 120
- AMP-DUAC**—pages 126-127
- 5.0 mm Power Key Connectors (PKC)**—page 137
- .093 Commercial Pin and Socket**—page 145
- Commercial MATE-N-LOK**—pages 155-156
- .140 MATE-N-LOK**—page 166
- Universal MATE-N-LOK**—pages 172-173
- Universal MATE-N-LOK II**—page 192
- .156 MATE-N-LOK**—page 203

CERTI-CRIMP II Hand Tool



Catalog 65780

PRO-CRIMPER III Hand Tool



Catalog 82276

| Features | CERTI-CRIMP Hand Tool | PRO-CRIMPER III Hand Tool |
|--|-----------------------|---------------------------|
| Field Repair/Prototyping | X | X |
| OEM Applications/Low Volume Production | X | — |
| Ratchet Control | X | X |
| Brush/Bellmouth Control | X | X |
| Precision Crimp Height Control | X | X |
| Little/No Operator Training | X | — |
| Insulation Adjustment | X | — |
| Repairable | X | — |

| Density | Product Line | CERTI-CRIMP Hand Tool | | PRO-CRIMPER III Hand Tool | |
|-----------------------------|--|-----------------------|-------------------|---------------------------|-------------------|
| | | Part Number | Instruction Sheet | Part Number | Instruction Sheet |
| High | 2.5 mm Signal Double Lock (SDL) | 234603-1 | 411-5735 | — | — |
| | | 234604-1 | 411-5736 | — | — |
| | Micro MATE-N-LOK 3 mm | 91501-1 | 408-8547 | — | — |
| | | 91502-1 | 408-8547 | — | — |
| | Grace Inertia Connectors (GIC) 3.5 | 1596277-1 | 411-78101 | — | — |
| | | — | — | 90870-1 | 408-9965 |
| | .062 Commercial Pin & Socket | — | — | 90869-1 | 408-9964 |
| | | — | — | — | — |
| | Power Double Lock (PDL) | 91567-1 | 408-8547 | — | — |
| | | 91569-1 | 408-8547 | — | — |
| | Mini-Universal MATE-N-LOK and Sealed Mini-Universal MATE-N-LOK | 91529-1 | 408-8547 | 90758-1 | 408-9938 |
| | | 91522-1 | 408-8547 | 90759-1 | 408-9962 |
| | | 91594-1 | 408-8547 | 90760-1 | 408-9963 |
| | | 90717-2 | 408-4443 | — | — |
| Mini-Universal MATE-N-LOK 2 | 91529-1 | 408-8547 | — | — | |
| | 91522-1 | 408-8547 | — | — | |
| (MR) Miniature Rectangular | 91594-1 | 408-8547 | — | — | |
| | 90717-2 | 408-4443 | — | — | |
| VAL-U-LOK Connector System | 91534-1 | 408-8547 | 58514-1 | 408-9973 | |
| | 91526-1 | 408-8547 | 58514-1 | 408-9973 | |
| AMP-DUAC | — | — | 91387-1 | 408-8917 | |
| | — | — | 91388-1 | 408-8918 | |
| Standard | 5.0 mm Power Key Connectors (PKC) | 90714-1 | 408-4385 | — | — |
| | | 734202-2 | — | — | — |
| | .093 Commercial Pin & Socket | — | — | 90872-1 | 408-9967 |
| | | — | — | 90871-1 | 408-9966 |
| | Commercial MATE-N-LOK | 91515-1 | 408-8547 | — | — |
| | | 91512-1 | 408-8547 | 90574-1 | 408-9886 |
| | | 91504-1 | 408-8547 | 90575-1 | 408-9887 |
| | .140 MATE-N-LOK | 91552-1 | 408-8547 | — | — |
| | | 69710-1 ¹ | 408-2095 | — | — |
| | Universal MATE-N-LOK and Universal MATE-N-LOK II | 58373-1 ² | 408-9442 | — | — |
| | | 58374-1 ² | 408-9442 | — | — |
| | | 58439-1 | 408-9591 | — | — |
| | | 91510-1 | 408-8547 | 90548-1 | 408-9885 |
| | .156 MATE-N-LOK | 91500-1 | 408-8547 | 90546-1 | 408-9883 |
| 91508-1 | | 408-8547 | 90547-1 | 408-9884 | |
| 91506-1 | | 408-8547 | 90547-1 | 408-9884 | |
| 69710-1 ¹ | | 408-2095 | — | — | |
| 58380-1 ² | | 408-9433 | — | — | |
| 58380-2 ² | | 408-9433 | — | — | |
| 58631-1 | 408-4341 | — | — | | |
| 58632-1 | 408-4340 | — | — | | |

¹Hand tool requires die set. ²Die set.
Note: This listing is for reference purposes only. To obtain part numbers for specific applications call Technical Support.

Applicator Options

| | Strip Form Contact Part Number | | Heavy-Duty Miniature Applicator Part Numbers | | | |
|--|--------------------------------|------------|--|-------------------------------|--|--|
| | Pin | Socket | Used on Bench Top Terminators | | Used on Automatic Leadmaking Equipment (AMPOMATOR CLS Machine with T or G Terminators) | Used on AMP-O-MATIC Stripper-Crimper Machine |
| | | | AMP-O-LECTRIC Model K Machine | AMP-O-LECTRIC Model G Machine | | |
| 2.5 mm Signal Double Lock (SDL) Contacts | 917764-1 | 917683-1 | * | * | * | * |
| | 917765-1 | 917684-1 | * | * | * | * |
| Micro MATE-N-LOK 3 mm Connector System | 1-794608-0 | — | | | | |
| | 1-794608-1 | — | 1385194-2 | 1385194-3 | 1385194-1 | — |
| | 1-794608-2 | — | | | | |
| | 1-794609-0 | — | | | | |
| | 1-794609-1 | — | 1385377-2 | 1385377-3 | 1385377-1 | — |
| | 1-794609-2 | — | | | | |
| | — | 794606-1 | | | | |
| | — | 1-794606-1 | 680893-2 | 680893-3 | 680893-1 | — |
| | — | 1-794606-2 | | | | |
| | — | 794607-1 | | | | |
| — | 1-794607-1 | 680894-2 | 680894-3 | 680894-1 | — | |
| — | 1-794607-2 | | | | | |
| Grace Inertia Connectors (GIC) 3.5 | 1565080-1 | 1565079-1 | * | * | * | * |
| | 1612335-1 | 1612334-1 | * | * | * | * |
| .062 Commercial Pin and Socket Contacts | 640391-1 | 640392-1 | | | | |
| | 640391-5 | 640392-5 | | | | |
| | — | 640392-2 | 466686-2 | 466686-3 | 466686-1 | 466955-1 |
| | — | 794046-1 | | | | |
| | 350629-1 | 350628-1 | | | | |
| | — | 350628-2 | | | | |
| | 350629-5 | 350628-5 | 687996-2 | 687996-3 | 687996-1 | — |
| | — | 350628-6 | | | | |
| — | 794103-1 | | | | | |
| Power Double Lock (PDL) | 177916-1 | 177914-1 | * | * | * | * |
| | | 177914-2† | * | * | * | * |
| | 177917-1 | 177915-1 | * | * | * | * |
| | | 177915-2† | * | * | * | * |
| † High contact pressure type. | | | | | | |
| Mini-Universal MATE-N-LOK Contacts | 770835-1 | 770834-1 | | | 567418-1 | — |
| | 1-770835-0 | 1-770834-0 | | | | |
| | 770901-1 | 770902-1 | | | 567066-3 | 466990-2 |
| | 1-770901-0 | 1-770902-0 | 567066-4 | 567066-5 | 567066-3 | |
| | 770903-1 | 770904-1 | | | 567067-1 | 466986-1 |
| | 1-770903-0 | 1-770904-0 | 567067-2 | 567067-3 | 567067-1 | |
| | 171636-1 | 171637-1 | | | 680582 | 567902-1 |
| — | 171637-3 | 680582 | 567251-1 | 680582 | | |
| Mini-Universal MATE-N-LOK 2 Contacts | 794216-1 | 794217-1 | | | 567418-1 | — |
| | 1-794216-0 | 1-794217-0 | 567418-2 | 567418-3 | 567418-1 | |
| | 794218-1 | 794219-1 | | | 567066-3 | 466990-2 |
| | 1-794218-0 | 1-794219-0 | 567066-4 | 567066-5 | 567066-3 | |
| | 794220-1 | 794221-1 | | | 680854-1 | 466986-1 |
| | 1-794220-0 | 1-794221-0 | 680854-2 | 680854-3 | 680854-1 | |
| | 794222-1 | 794223-1 | | | — | 567902-1 |
| | 1-794222-0 | 1-794223-0 | 680582-2 | 680582-3 | | |
| (MR) Miniature Rectangular Contacts | 350968-1 | 794000-1 | | | 466352-1 | — |
| | 350968-2 | 794000-2 | 466352-2 | 466352-3 | 466352-1 | |
| | 350967-1 | 641294-1 | | | 466351-1 | 466913-1 |
| | 350967-2 | 641294-2 | 466351-2 | 466351-4 | 466351-1 | |
| | 350969-1 | — | 466351-2 | 466351-4 | 466351-1 | 466913-1 |
| | 350969-2 | — | 466351-2 | 466351-4 | 466351-1 | 466913-1 |

Note: Stripper Crimper (SCA) and Crimp Quality Monitor Applicators may be available. Call Technical Support for Part Numbers.

* Contact the Tooling Assistance Center (TAC) at 1-800-722-1111 for Applicator Part Numbers.

Note: All part numbers are RoHS Compliant.

Applicator Options (Continued)

Applicator Options

| | Strip Form Contact Part Number | | Heavy-Duty Miniature Applicator Part Numbers | | | |
|--|--------------------------------|------------|--|-------------------------------|--|--|
| | | | Used on Bench Top Terminators | | Used on Automatic Leadmaking Equipment (AMPOMATOR CLS Machine with T or G Terminators) | Used on AMP-O-MATIC Stripper-Crimper Machine |
| | Pin | Socket | AMP-O-LECTRIC Model K Machine | AMP-O-LECTRIC Model G Machine | | |
| VAL-U-LOK Connector System | 794955-1 | 794956-1 | | | | |
| | 794955-2 | 794956-2 | | | | |
| | 794955-3 | 794956-3 | 1385817-2 | 1385817-3 | 1385817-1 | — |
| | 794955-4 | 794956-4 | | | | |
| | 794957-1 | 794958-1 | | | | |
| | 794957-2 | 794958-2 | | | | |
| | 794957-3 | 794958-3 | 1385448-2 | 1385448-3 | 1385448-1 | — |
| AMP-DUAC | 794957-4 | 794958-4 | | | | |
| | 794576-1 | 106529-2 | 680308-2 | 680308-3 | — | 567959-1 |
| | | 1-794138-3 | | | | |
| | 794578-1 | 106528-2 | 680307-2 | 680307-3 | — | 567960-1 |
| | | 1-794139-3 | | | | |
| 5.0 mm Power Key Connectors (PKC) | — | 1-794140-3 | 680350-2 | 680350-3 | — | — |
| | | 794418-1 | | | | |
| | — | 1376347-1 | * | * | * | * |
| .093 Commercial Pin and Socket Contacts | — | 1376348-1 | * | * | * | * |
| | 350418-1 | 350417-1 | | | | |
| | — | 350417-3 | 466656-2 | 466656-3 | 466656-1 | 466922-1 |
| | 350418-5 | 350417-5 | | | | |
| | 350416-1 | 350415-1 | 466878-2 | 466878-3 | 466878-1 | 466959-1 |
| | 350416-5 | 350415-5 | | | | |
| | 770530-1 | 770529-1 | 567337-4 | 567337-6 | 567337-3 | — |
| 770385-1 | 770383-1 | 567273-2 | 567273-4 | 567273-3 | — | |
| Commercial MATE-N-LOK Contacts | — | — | | | | |
| | 350079-1 | 350078-1 | | | | |
| | 350079-4 | 350078-4 | 466426-2 | 466426-3 | 466426-1 | — |
| | 350079-5 | 350078-5 | | | | |
| | 61116-1 | 61314-1 | | | | |
| | 61116-4 | 61314-4 | | | | |
| | 61116-5 | 61314-5 | 466320-2 | 466320-4 | 466320-1 | 466917-1 |
| | 61116-6 | 61314-6 | | | | |
| | 61116-7 | 61314-7 | | | | |
| | 61118-1 | 61117-1 | | | | |
| | 61118-4 | 61117-4 | | | | |
| | 61118-5 | 61117-5 | 687763-2 | 687763-6 | 687763-1 | 466920-1 |
| | 61118-6 | 61117-6 | | | | |
| | 61118-7 | 61117-7 | | | | |
| | 350558-1 | 350557-1 | | | | |
| 350558-4 | 350557-4 | 687898-2 | 687898-4 | 687898-1 | — | |
| 61527-2 | — | 466320-2 | 466320-4 | 466320-1 | 466917-1 | |
| .140 MATE-N-LOK Contacts | 61627-1 | 61626-1 | 567306-2 | 567306-3 | 567306-1 | — |
| | 61627-2 | 61626-2 | | | | |
| | 350201-1 | 350200-1 | 567309-2 | 567309-3 | 587309-1 | — |
| | 350201-2 | 350200-2 | | | | |
| Universal MATE-N-LOK Contacts | 350924-1 | 350925-1 | 466616-2 | 466616-3 | — | — |
| | 350924-6 | 350925-6 | | | | |
| | 350561-1 | 350851-1 | | | | |
| | — | 350570-1 | | | | |
| | 350561-2 | 350851-2 | | | | |
| | — | 350570-2 | | | | |
| | 350561-7 | 350851-7 | 466320-2 | 466320-4 | 466320-1 | 466917-1 |
| | — | 350570-7 | | | | |
| | 350561-3 | 350570-3 | | | | |
| — | 350570-6 | | | | | |

Note: Stripper Crimper (SCA) and Crimp Quality Monitor Applicators may be available. Call Technical Support for Part Numbers.

* Contact the Tooling Assistance Center (TAC) at 1-800-722-1111 for Applicator Part Numbers.

Note: All part numbers are RoHS Compliant.

Applicator Options (Continued)

**Universal
MATE-N-LOK
Contacts** (Continued)

**Universal
MATE-N-LOK II
Contacts**

**.156 MATE-N-LOK
Contacts**

| Strip Form Contact Part Number | | Heavy-Duty Miniature Applicator Part Numbers | | | |
|--------------------------------|------------|--|-------------------------------|--|--|
| Pin | Socket | Used on Bench Top Terminators | | Used on Automatic Leadmaking Equipment (AMPOMATOR CLS Machine with T or G Terminators) | Used on AMP-O-MATIC Stripper-Crimper Machine |
| | | AMP-O-LECTRIC Model K Machine | AMP-O-LECTRIC Model G Machine | | |
| 350218-1 | 350536-1 | | | | |
| 350218-2 | 350536-2 | | | | |
| 350218-7 | 350536-7 | 687763-2 | 687763-6 | 687763-1 | 466920-1 |
| 350218-3 | 350536-3 | | | | |
| 350218-6 | 350536-6 | | | | |
| 350538-1 | 350537-1 | | | | |
| 350538-2 | 350537-2 | | | | |
| 350538-7 | 350537-7 | 687926-2 | 687926-6 | 687926-1 | 466989-1 |
| 350538-3 | 350537-3 | | | | |
| 350538-6 | 350537-6 | | | | |
| 350873-1 | 350874-1 | | | | |
| 350873-3 | 350874-3 | 466588-2 | 466588-3 | 466588-1 | — |
| 350922-3 | 350923-3 | | | | |
| 350922-6 | 350923-6 | 466597-2 | 466597-3 | 466597-1 | — |
| 350922-4 | 350923-4 | | | | |
| 350699-1 | — | | | | |
| 350699-2 | — | 466320-2 | 466320-4 | 466320-1 | 466917-1 |
| 350699-7 | — | | | | |
| 350687-1 | — | | | | |
| 350687-2 | — | 687763-2 | 687763-6 | 687763-1 | 466920-1 |
| 350687-7 | — | | | | |
| 350700-1 | — | | | | |
| 350700-2 | — | 687926-2 | 687926-6 | 687926-1 | 466989-1 |
| 350700-7 | — | | | | |
| 770210-1 | — | 567216-2 | 567216-3 | 567216-1 | |
| 350654-1 | — | 687763-2 | 687763-6 | 687763-1 | 466920-1 |
| 770234-3 | — | 466597-2 | 466597-3 | 466597-1 | |
| 770011-6 | 770012-6 | — | 567252-4 | 567252-1 | — |
| 770009-1 | — | | | | |
| 1-770009-0 | — | | | | |
| — | 770010-3 | — | 567214-4 | 567214-1 | 567914-1 |
| — | 1-770010-0 | | | | |
| 770007-1 | — | | | | |
| 1-770007-0 | — | | | | |
| — | 770008-3 | — | 567213-4 | 567213-1 | 567913-1 |
| — | 1-770008-0 | | | | |
| 770005-1 | — | | | | |
| 1-770005-0 | — | | | | |
| — | 770006-3 | — | 567212-4 | 567212-1 | — |
| 1-770005-1 | 1-770006-0 | | | | |
| 770003-3 | 770004-3 | | | | |
| 1-770003-0 | 1-770004-0 | — | 567211-4 | 567211-1 | — |
| 770193-1 | — | | | | |
| 1-770193-0 | — | — | 567213-4 | 567213-1 | 567913-1 |
| 770194-1 | — | | | | |
| 1-770194-0 | — | — | 567212-4 | 567212-1 | — |
| 61086-1 | 61085-1 | 466462-1 | 466462-3 | 466462-1 | — |
| 61234-1 | 61233-1 | 687765-2 | 687765-2 | — | — |

Applicator Options

Note: Stripper Crimper (SCA) and Crimp Quality Monitor Applicators may be available. Call Technical Support for Part Numbers.

* Contact the Tooling Assistance Center (TAC) at 1-800-722-1111 for Applicator Part Numbers.

Note: All part numbers are RoHS Compliant.

Product Feature Comparisons

| High Density | 2.5 mm Signal Double Lock (SDL) | Micro MATE-N-LOK 3 mm | Grace Inertia Connectors (GIC) 3.5 | .062 Commercial Pin & Socket | Power Double Lock (PDL) | Mini-Universal MATE-N-LOK | Sealed Mini-Universal MATE-N-LOK | Mini-Universal MATE-N-LOK 2 | (MR) Miniature Rectangular | VAL-U-LOK Connector System | AMP-DUAC |
|-----------------------------------|---------------------------------|-----------------------|------------------------------------|------------------------------|--|---------------------------|----------------------------------|-----------------------------|----------------------------|----------------------------|-------------|
| Wire AWG — | | | | | | | | | | | |
| Maximum | 20 | 20 | 18 | 18 | 16 | 16 | 18 | 16 | 18 | 18 | 18 |
| Minimum | 26 | 30 | 26 | 30 | 26 | 30 | 26 | 30 | 26 | 26 | 26 |
| Current Rating — | | | | | | | | | | | |
| 10 AWG Wire | — | — | — | — | — | — | — | — | — | — | — |
| 14 AWG Wire | — | — | — | — | — | — | — | — | — | — | — |
| 16 AWG Wire | — | — | — | — | 14 | — | — | — | — | — | — |
| 18 AWG Wire | — | ** | 7 | 17 | — | 9 | 9 | 10.5 | 6 | 9 | 9 |
| 20 AWG Wire | 3 | — | — | — | — | — | — | — | — | — | — |
| Max. Operating Voltage (AC or DC) | 50 | 250 | 300 | 250 | 300 | 600 | 600 | 600 | 250 | 600 | 600 |
| Flammability Rating — | | | | | | | | | | | |
| UL 94V-0 | Yes | Yes | Yes | No | Yes | Yes | Yes | Yes | Yes | Yes | Yes |
| UL 94V-2 | No | No | No | Yes | No | Yes* | No | Yes | No | Yes | Yes |
| Approvals — | | | | | | | | | | | |
| UL | Yes | Yes | Yes | Yes | Yes | Yes | Yes | Submitted | Yes | Yes | Yes |
| CSA | Yes | Yes | Yes | Yes | Yes | Yes | Yes | Submitted | Yes | Yes | Yes |
| VDE | Yes | Yes | — | No | Yes | Yes | Yes | Submitted | No | — | No |
| Contact Material — | | | | | | | | | | | |
| Brass | No | Yes | Yes | Yes | Yes | Yes | Yes | Yes | No | Yes | — |
| Phos. Bronze | Yes | Yes | No | Yes | No | Yes | Yes | No | Yes | Yes | Yes |
| Plating Finish — | | | | | | | | | | | |
| Tin Plating | Yes | Yes | Yes | Yes | Yes | Yes | Yes | Yes | Yes | Yes | Yes |
| Gold Plating | No | Yes | No | Yes | No | Yes | Yes | Yes | Yes | Yes | Yes |
| Centerline Spacing — | .098 [2.50] | .118 [3.00] | .137 [3.50] | .145 [3.68] | .156 [3.96] 256 [6.50] .312 [7.92] .512 [13.00] | .163 [4.14] | .163 [4.14] | .163 [4.14] | .165 [4.20] | .165 [4.20] | .165 [4.20] |
| Housings — | | | | | | | | | | | |
| Panel Mount | No | Yes | No | Yes | Yes | Yes | Yes | No | Yes | Yes | Yes |
| Free-Hanging | Yes | Yes | Yes | Yes | Yes | Yes | No | Yes | Yes | Yes | Yes |
| Secondary Locking Latches | Yes | No | Yes | No | Yes | No | No | Yes | No | Yes | Yes |
| Contact Position Control | Yes | No | No | No | No | No | No | Yes | No | No | Yes |
| In-Line Config. | Yes | Yes | Yes | Yes | Yes | Yes | No | Yes | Yes | Yes | Yes |
| Dual Row Config. | No | Yes | Yes | No | Yes | Yes | Yes | Yes | No | Yes | Yes |
| Matrix Config. | No | No | No | Yes | Yes | Yes | No | Yes | Yes | No | No |
| Accessories — | | | | | | | | | | | |
| Strain Relief | No | No | Yes | No | Yes | Yes | No | No | Yes | No | Yes |
| Keying Plug | No | No | No | No | No | Yes | Yes | Yes | Yes | No | No |
| Seals | No | No | No | No | No | Yes | Yes | No | No | No | No |
| Headers — | | | | | | | | | | | |
| Vertical | Yes | Yes | No | No | Yes | Yes | Yes | Mini-Universal MATE-N-LOK | Yes | Yes | Yes |
| Blindmate | No | No | No | No | No | Yes | Yes | Mini-Universal MATE-N-LOK | No | Yes | No |
| Right-Angle | Planned | Yes | No | No | No | Yes | Yes | Mini-Universal MATE-N-LOK | No | Yes | Yes |
| Positions — | | | | | | | | | | | |
| Minimum | 2 | 2 | 2 | 1 | 1 | 1 | 2 | 2 | 2 | 2 | 2 |
| Maximum | 13 | 24 | 6 | 9 | 12 | 24 | 10 | 24 | 36 | 24 | 24 |

* Wire-to-Wire Only.
** 5 A on 20 AWG*

Product Feature Comparisons (Continued)

| Standard Density | 5.0 mm Power Key Connectors (PKC) | .093 Commercial Pin & Socket | Commercial MATE-N-LOK | .140 MATE-N-LOK | Universal MATE-N-LOK | Universal MATE-N-LOK II | .156 MATE-N-LOK |
|-----------------------------------|-----------------------------------|---|---|-----------------|----------------------|-------------------------|-----------------|
| Wire AWG— | | | | | | | |
| Maximum | 16 | 14 | 14 | 10 | 10 | 10 | 10 |
| Minimum | 24 | 24 | 30 | 20 | 30 | 30 | 20 |
| Current Rating — | | | | | | | |
| 10 AWG Wire | — | — | — | 28 | — | — | 32.5 |
| 14 AWG Wire | — | 19 | 13 | — | 15 | 19 | — |
| 16 AWG Wire | 10 | — | — | — | — | — | — |
| 18 AWG Wire | — | — | — | — | — | — | — |
| 20 AWG Wire | — | — | — | — | — | — | — |
| Max. Operating Voltage (AC or DC) | 300 | 250 | 250 | 600 | 600 | 600 | 600 |
| Flammability Rating — | | | | | | | |
| UL 94V-0 | Yes | No | Yes | No | Yes | Yes | No |
| UL 94V-2 | No | Yes | Yes | Yes | Yes | No | Yes |
| Approvals — | | | | | | | |
| UL | Yes | Yes | Yes | Yes | Yes | Yes | Yes |
| CSA | Yes | Yes | Yes | Yes | Yes | Yes | No |
| VDE | No | No | No | No | Yes | Yes | No |
| Contact Material — | | | | | | | |
| Brass | Yes | Yes | Yes | Yes | Yes | Yes | Yes |
| Phos. Bronze | No | Yes | Yes | Yes | Yes | Yes | No |
| Plating Finish — | | | | | | | |
| Tin Plating | Yes | Yes | Yes | Yes | Yes | Yes | Yes |
| Gold Plating | No | Yes | Yes | No | Yes | Yes | No |
| Centerline Spacing — | .197 [5.00] | .198 [5.03] .250 [6.35] .248 [6.30] | .200 [5.08] .240 [6.10] x .202 [5.13] .195 [4.95] x .360 [9.14] | .240 [6.10] | .250 [6.35] | .250 [6.35] | .390 [9.91] |
| Housings — | | | | | | | |
| Panel Mount | No | Yes | Yes | Yes | Yes | Yes | Yes |
| Free-Hanging | No | Yes | Yes | Yes | Yes | Yes | Yes |
| Secondary Locking Latches | Yes | No | No | Yes | No | Yes | Yes |
| Contact Position Control | No | No | No | No | No | Yes | No |
| In-Line Config. | Yes | Yes | Yes | Yes | Yes | Yes | Yes |
| Dual Row Config. | Yes | No | Yes | No | No | No | No |
| Matrix Config. | No | Yes | Yes | Yes | Yes | Yes | No |
| Accessories — | | | | | | | |
| Strain Relief | Yes | No | No | No | Yes | Universal MATE-N-LOK | No |
| Keying Plug | No | No | Yes | No | Yes | Yes | No |
| Seals | No | No | No | No | Yes | No | No |
| Headers — | | | | | | | |
| Vertical | Yes | No | Yes | No | Yes | Universal MATE-N-LOK | No |
| Blindmate | No | No | No | No | No | No | No |
| Right-Angle | No | No | Yes | No | Yes | Universal MATE-N-LOK | No |
| Positions — | | | | | | | |
| Minimum | 2 | 1 | 1 | 2 | 1 | 2 | 3 |
| Maximum | 6 | 15 | 16 | 9 | 15 | 15 | 4 |

* Wire-to-Wire Only.
** 5 A on 20 AWG*

Non-Compliant to RoHS Compliant Part Number Cross Reference

| Non-Compliant Part Number | RoHS Compliant Part Number | Non-Compliant Part Number | RoHS Compliant Part Number | Non-Compliant Part Number | RoHS Compliant Part Number | Non-Compliant Part Number | RoHS Compliant Part Number |
|---------------------------|----------------------------|---------------------------|----------------------------|---------------------------|----------------------------|---------------------------|----------------------------|
| 350209-2 | 1586512-2 | 350827-2 | 350827-4 | 643234-2 | 3-643234-0 | 770876-1 | 1-770876-0 |
| 350210-2 | 1586514-2 | 350828-2 | 350828-4 | 643236-2 | 3-643236-0 | 770876-2 | 1-770876-1 |
| 350211-2 | 1586515-2 | 350829-2 | 350829-4 | 643410-2 | 643410-3 | 770901-3 | 1-770901-0 |
| 350211-3 | 1586515-3 | 350830-2 | 350830-4 | 643412-2 | 643412-3 | 770902-3 | 1-770902-0 |
| 350212-2 | 1586518-2 | 350832-2 | 350832-4 | 643414-2 | 643414-3 | 770902-6 | 1-770902-1 |
| 350213-2 | 1586520-2 | 350833-2 | 350833-4 | 643424-2 | 643424-3 | 770903-3 | 1-770903-0 |
| 350214-2 | 1586522-2 | 350834-2 | 350834-4 | 643426-2 | 643426-3 | 770903-6 | 1-770903-1 |
| 350220-2 | 1586524-2 | 350835-2 | 350835-4 | 770003-4 | 1-770003-0 | 770904-3 | 1-770904-0 |
| 1-350375-0 | 2-350375-0 | 350836-2 | 350836-4 | 770004-4 | 1-770004-0 | 770904-6 | 1-770904-1 |
| 1-350376-0 | 2-350376-0 | 350837-2 | 350837-4 | 770005-2 | 1-770005-0 | 770966-1 | 1-770966-0 |
| 1-350377-0 | 2-350377-0 | 2-350942-0 | 3-350942-0 | 770005-4 | 1-770005-1 | 770966-2 | 1-770966-1 |
| 1-350378-1 | 2-350378-1 | 2-350943-0 | 3-350943-0 | 770006-4 | 1-770006-0 | 770967-1 | 1-770967-0 |
| 1-350379-1 | 2-350379-1 | 2-350944-0 | 3-350944-0 | 770007-2 | 1-770007-0 | 770967-2 | 1-770967-1 |
| 1-350380-1 | 2-350380-1 | 2-350945-0 | 3-350945-0 | 770008-4 | 1-770008-0 | 770968-1 | 1-770968-0 |
| 350424-2 | 1586525-2 | 350988-3 | 350988-5 | 770010-4 | 1-770010-0 | 770968-2 | 1-770968-1 |
| 350425-2 | 1586526-2 | 350989-3 | 350989-5 | 770166-1 | 1-770166-0 | 770969-1 | 1-770969-0 |
| 350426-2 | 1586528-2 | 350990-3 | 350990-5 | 770166-2 | 1-770166-1 | 770969-2 | 1-770969-1 |
| 350428-2 | 350428-4 | 350991-3 | 350991-5 | 770170-1 | 1-770170-0 | 770970-1 | 1-770970-0 |
| 350429-2 | 350429-4 | 1-380935-0 | 2-380935-0 | 770170-2 | 1-770170-1 | 770970-2 | 1-770970-1 |
| 350430-2 | 350430-4 | 1-380936-0 | 2-380936-0 | 770174-1 | 1-770174-0 | 770971-1 | 1-770971-0 |
| 350431-2 | 350431-4 | 1-380937-0 | 2-380937-0 | 770174-2 | 1-770174-1 | 770971-2 | 1-770971-1 |
| 350432-2 | 350432-4 | 2-380991-0 | 2-1586544-0 | 770178-1 | 1-770178-0 | 770972-1 | 1-770972-0 |
| 350433-2 | 350433-4 | 2-380999-0 | 2-1586546-0 | 770178-2 | 1-770178-1 | 770972-2 | 1-770972-1 |
| 350434-2 | 350434-4 | 640466-2 | 640466-3 | 770182-1 | 1-770182-0 | 770973-1 | 1-770973-0 |
| 350539-2 | 1586530-2 | 640467-2 | 640467-3 | 770182-2 | 1-770182-1 | 770973-2 | 1-770973-1 |
| 350541-2 | 1586532-2 | 640497-2 | 2-640497-2 | 770186-1 | 1-770186-0 | 770974-1 | 1-770974-0 |
| 350543-2 | 1586534-2 | 640497-4 | 2-640497-4 | 770186-2 | 1-770186-1 | 770974-2 | 1-770974-1 |
| 350544-2 | 1586536-2 | 640498-2 | 2-640498-2 | 770190-1 | 1-770190-0 | 770985-3 | 1-770985-0 |
| 350582-2 | 350582-4 | 640498-4 | 2-640498-4 | 770190-2 | 1-770190-1 | 770986-3 | 1-770986-0 |
| 350583-2 | 350583-4 | 640499-2 | 2-640499-2 | 770193-2 | 1-770193-0 | 770987-3 | 1-770987-0 |
| 350584-2 | 350584-4 | 640499-4 | 2-640499-4 | 770194-2 | 1-770194-0 | 770988-3 | 1-770988-0 |
| 350585-2 | 350585-4 | 640500-2 | 2-640500-2 | 770246-4 | 1-770246-0 | 794040-1 | 1-794040-0 |
| 350586-2 | 350586-4 | 640500-4 | 2-640500-4 | 770247-4 | 1-770247-0 | 794040-2 | 1-794040-1 |
| 350587-2 | 350587-4 | 640501-2 | 2-640501-2 | 770248-2 | 1-770248-0 | 794058-3 | 1-794058-0 |
| 350588-2 | 350588-4 | 640501-4 | 2-640501-4 | 770249-4 | 1-770249-0 | 794059-3 | 1-794059-0 |
| 350641-2 | 1586539-2 | 640502-2 | 2-640502-2 | 770250-2 | 1-770250-0 | 794065-1 | 1-794065-0 |
| 350711-2 | 350711-4 | 640502-4 | 2-640502-4 | 770251-4 | 1-770251-0 | 794065-2 | 1-794065-1 |
| 350712-2 | 350712-4 | 640503-2 | 2-640503-2 | 770252-2 | 1-770252-0 | 794066-1 | 1-794066-0 |
| 350713-2 | 350713-4 | 640503-4 | 2-640503-4 | 770254-2 | 1-770254-0 | 794066-2 | 1-794066-1 |
| 350714-2 | 350714-4 | 640504-2 | 2-640504-2 | 770255-2 | 1-770255-0 | 794067-1 | 1-794067-0 |
| 350714-3 | 350714-5 | 640504-4 | 2-640504-4 | 770262-2 | 770262-3 | 794067-2 | 1-794067-1 |
| 350732-2 | 350732-4 | 640505-2 | 2-640505-2 | 770328-1 | 1586627-1 | 794068-1 | 1-794068-0 |
| 350737-2 | 350737-4 | 640505-4 | 2-640505-4 | 1-770328-1 | 1-1586627-1 | 794068-2 | 1-794068-1 |
| 350738-2 | 350738-4 | 640506-2 | 2-640506-2 | 770621-1 | 1-770621-0 | 794069-1 | 1-794069-0 |
| 350742-2 | 350742-4 | 640506-4 | 2-640506-4 | 770621-2 | 1-770621-1 | 794069-2 | 1-794069-1 |
| 350759-3 | 350759-5 | 640583-2 | 640583-3 | 770743-1 | 1-770743-0 | 794070-1 | 1-794070-0 |
| 350760-3 | 350760-5 | 640584-2 | 640584-3 | 770743-2 | 1-770743-1 | 794070-2 | 1-794070-1 |
| 350761-3 | 350761-5 | 640900-2 | 640900-3 | 770834-3 | 1-770834-0 | 794071-1 | 1-794071-0 |
| 350762-3 | 350762-5 | 640901-2 | 640901-3 | 770834-6 | 1-770834-1 | 794071-2 | 1-794071-1 |
| 350763-3 | 350763-5 | 641831-2 | 641831-3 | 770835-3 | 1-770835-0 | 794072-1 | 1-794072-0 |
| 350764-3 | 350764-5 | 641832-2 | 641832-3 | 770858-1 | 1-770858-0 | 794072-2 | 1-794072-1 |
| 350765-3 | 350765-5 | 641963-2 | 641963-3 | 770858-2 | 1-770858-1 | 794073-1 | 1-794073-0 |
| 350786-2 | 350786-3 | 641964-2 | 641964-3 | 770859-1 | 1-770859-0 | 794073-2 | 1-794073-1 |
| 350787-2 | 350787-3 | 641970-2 | 641970-3 | 770859-2 | 1-770859-1 | 794074-1 | 1-794074-0 |
| 350789-2 | 350789-3 | 641971-2 | 641971-3 | 770872-1 | 1-770872-0 | 794074-2 | 1-794074-1 |
| 350790-2 | 350790-3 | 641972-2 | 641972-3 | 770872-2 | 1-770872-1 | 794075-2 | 1-794075-1 |
| 350792-2 | 350792-3 | 641974-2 | 641974-3 | 770873-1 | 1-770873-0 | 794076-1 | 1-794076-0 |
| 350793-2 | 350793-3 | 641976-2 | 641976-4 | 770873-2 | 1-770873-1 | 794076-2 | 1-794076-1 |
| 350824-2 | 350824-4 | 643228-2 | 3-643228-0 | 770874-2 | 1-770874-1 | 794077-1 | 1-794077-0 |
| 350825-2 | 350825-4 | 643230-2 | 3-643230-0 | 770875-1 | 1-770875-0 | 794077-2 | 1-794077-1 |
| 350826-2 | 350826-4 | 643232-2 | 3-643232-0 | 770875-2 | 1-770875-1 | 794078-1 | 1-794078-0 |

Non-Compliant to RoHS Compliant Part Number Cross Reference

Non-Compliant to RoHS Compliant Part Number Cross Reference (Continued)

| Non-Compliant Part Number | RoHS Compliant Part Number |
|---------------------------|----------------------------|
| 794078-2 | 1-794078-1 |
| 794079-1 | 1-794079-0 |
| 794079-2 | 1-794079-1 |
| 794105-1 | 1-794105-0 |
| 794105-2 | 1-794105-1 |
| 794106-1 | 1-794106-0 |
| 794106-2 | 1-794106-1 |
| 794107-1 | 1-794107-0 |
| 794107-2 | 1-794107-1 |
| 794108-1 | 1-794108-0 |
| 794108-2 | 1-794108-1 |
| 794126-1 | 1-794126-0 |
| 794130-2 | 1-794130-1 |
| 794136-3 | 1-794136-1 |
| 794137-3 | 1-794137-1 |
| 794138-3 | 1-794138-3 |
| 794139-3 | 1-794139-3 |
| 794140-3 | 1-794140-3 |
| 794141-3 | 1-794141-3 |
| 794142-3 | 1-794142-3 |
| 794143-3 | 1-794143-3 |
| 794181-1 | 1-794181-1 |
| 794181-2 | 1-794181-2 |
| 794216-3 | 1-794216-0 |
| 794217-3 | 1-794217-0 |
| 794218-3 | 1-794218-0 |
| 794219-3 | 1-794219-0 |
| 794220-3 | 1-794220-0 |
| 794221-3 | 1-794221-0 |
| 794222-3 | 1-794222-0 |
| 794223-3 | 1-794223-0 |
| 794224-3 | 1-794224-0 |
| 794225-3 | 1-794225-0 |
| 794226-3 | 1-794226-0 |
| 794227-3 | 1-794227-0 |
| 794228-3 | 1-794228-0 |
| 794229-3 | 1-794229-0 |
| 794230-3 | 1-794230-0 |
| 794231-3 | 1-794231-0 |
| 794302-1 | 1-794302-1 |
| 794302-2 | 1-794302-2 |
| 794303-1 | 1-794303-1 |
| 794303-2 | 1-794303-2 |
| 794304-1 | 1-794304-1 |
| 794304-2 | 1-794304-2 |
| 794305-1 | 1-794305-1 |
| 794305-2 | 1-794305-2 |
| 794306-1 | 1-794306-1 |
| 794306-2 | 1-794306-2 |
| 794307-1 | 1-794307-1 |
| 794307-2 | 1-794307-2 |
| 794308-1 | 1-794308-1 |
| 794308-2 | 1-794308-2 |
| 794309-1 | 1-794309-1 |
| 794309-2 | 1-794309-2 |
| 794310-1 | 1-794310-1 |
| 794310-2 | 1-794310-2 |
| 794311-1 | 1-794311-1 |
| 794311-2 | 1-794311-2 |
| 794312-1 | 1-794312-1 |
| 794312-2 | 1-794312-2 |

| Non-Compliant Part Number | RoHS Compliant Part Number |
|---------------------------|----------------------------|
| 794313-1 | 794313-3 |
| 794313-2 | 794313-4 |
| 794325-1 | 1-794325-0 |
| 794326-2 | 1-794326-1 |
| 794327-1 | 1-794327-0 |
| 794327-2 | 1-794327-1 |
| 794328-1 | 1-794328-0 |
| 794330-2 | 1-794330-1 |
| 794349-1 | 1-794349-1 |
| 794349-2 | 1-794349-2 |
| 794350-1 | 1-794350-1 |
| 794350-2 | 1-794350-2 |
| 794351-1 | 1-794351-1 |
| 794351-2 | 1-794351-2 |
| 794352-1 | 1-794352-1 |
| 794352-2 | 1-794352-2 |
| 794353-1 | 1-794353-1 |
| 794353-2 | 1-794353-2 |
| 794354-1 | 1-794354-1 |
| 794354-2 | 1-794354-2 |
| 794355-1 | 1-794355-1 |
| 794355-2 | 1-794355-2 |
| 794356-1 | 1-794356-1 |
| 794356-2 | 1-794356-2 |
| 794357-1 | 1-794357-1 |
| 794357-2 | 1-794357-2 |
| 794358-1 | 1-794358-1 |
| 794358-2 | 1-794358-2 |
| 794359-1 | 1-794359-1 |
| 794359-2 | 1-794359-2 |
| 794360-1 | 1-794360-1 |
| 794360-2 | 1-794360-2 |
| 794374-1 | 1-794374-0 |
| 794374-2 | 1-794374-1 |
| 794406-3 | 1-794406-0 |
| 794407-3 | 1-794407-0 |
| 794415-1 | 1-794415-1 |
| 794415-2 | 1-794415-2 |
| 794429-1 | 1-794429-1 |
| 794429-2 | 1-794429-2 |
| 794448-1 | 1-794448-1 |
| 794449-1 | 1-794449-1 |
| 794453-1 | 1-794453-1 |
| 794453-2 | 1-794453-2 |
| 794454-1 | 1-794454-1 |
| 794454-2 | 1-794454-2 |
| 794455-1 | 1-794455-1 |
| 794455-2 | 1-794455-2 |
| 794466-1 | 1-794466-1 |
| 794466-2 | 1-794466-2 |
| 794467-1 | 1-794467-1 |
| 794467-2 | 1-794467-2 |
| 794468-1 | 1-794468-1 |
| 794468-2 | 1-794468-2 |
| 794469-1 | 1-794469-1 |
| 794469-2 | 1-794469-2 |
| 794470-1 | 1-794470-1 |
| 794470-2 | 1-794470-2 |
| 794471-1 | 1-794471-1 |
| 794471-2 | 1-794471-2 |
| 794472-1 | 1-794472-1 |

| Non-Compliant Part Number | RoHS Compliant Part Number |
|---------------------------|----------------------------|
| 794472-2 | 1-794472-2 |
| 794484-1 | 1-794484-1 |
| 794484-2 | 1-794484-2 |
| 794485-1 | 1-794485-1 |
| 794485-2 | 1-794485-2 |
| 794486-1 | 1-794486-1 |
| 794486-2 | 1-794486-2 |
| 794487-1 | 1-794487-1 |
| 794487-2 | 1-794487-2 |
| 794488-1 | 1-794488-1 |
| 794488-2 | 1-794488-2 |
| 794489-1 | 1-794489-1 |
| 794489-2 | 1-794489-2 |
| 794490-1 | 1-794490-1 |
| 794490-2 | 1-794490-2 |
| 794491-1 | 1-794491-1 |
| 794491-2 | 1-794491-2 |
| 794492-1 | 1-794492-1 |
| 794492-2 | 1-794492-2 |
| 794493-1 | 1-794493-1 |
| 794493-2 | 1-794493-2 |
| 794494-1 | 1-794494-1 |
| 794494-2 | 1-794494-2 |
| 794507-1 | 1-794507-1 |
| 794508-1 | 1-794508-1 |
| 794509-1 | 1-794509-1 |
| 794510-1 | 1-794510-1 |
| 794511-1 | 1-794511-1 |
| 794512-1 | 1-794512-1 |
| 794513-1 | 1-794513-1 |
| 794514-1 | 1-794514-1 |
| 794515-1 | 1-794515-1 |
| 794516-1 | 1-794516-1 |
| 794526-1 | 1-794526-1 |
| 794527-1 | 1-794527-1 |
| 794528-1 | 1-794528-1 |
| 794529-1 | 1-794529-1 |
| 794530-1 | 1-794530-1 |
| 794531-1 | 1-794531-1 |
| 794532-1 | 1-794532-1 |
| 794533-1 | 1-794533-1 |
| 794534-1 | 1-794534-1 |
| 794540-1 | 1-794540-1 |
| 794540-2 | 1-794540-2 |
| 794543-1 | 1-794543-1 |
| 794543-2 | 1-794543-2 |
| 794576-2 | 794576-4 |
| 794578-2 | 794578-4 |
| 794588-1 | 1-794588-1 |
| 794589-1 | 1-794589-1 |
| 794590-1 | 1-794590-1 |
| 794606-2 | 1-794606-1 |
| 794606-3 | 1-794606-2 |
| 794607-2 | 1-794607-1 |
| 794607-3 | 1-794607-2 |
| 794608-1 | 1-794608-0 |
| 794608-2 | 1-794608-1 |
| 794608-3 | 1-794608-2 |
| 794609-1 | 1-794609-0 |
| 794609-2 | 1-794609-1 |
| 794609-3 | 1-794609-2 |

| Non-Compliant Part Number | RoHS Compliant Part Number |
|---------------------------|----------------------------|
| 794610-2 | 1-794610-1 |
| 794610-3 | 1-794610-2 |
| 794611-2 | 1-794611-1 |
| 794611-3 | 1-794611-2 |
| 794612-1 | 1-794612-0 |
| 794612-2 | 1-794612-1 |
| 794612-3 | 1-794612-2 |
| 794613-1 | 1-794613-0 |
| 794613-2 | 1-794613-1 |
| 794613-3 | 1-794613-2 |
| 794618-2 | 3-794618-2 |
| 794618-4 | 3-794618-4 |
| 794618-6 | 3-794618-6 |
| 794618-8 | 3-794618-8 |
| 1-794618-0 | 4-794618-0 |
| 1-794618-2 | 4-794618-2 |
| 1-794618-4 | 4-794618-4 |
| 1-794618-6 | 4-794618-6 |
| 1-794618-8 | 4-794618-8 |
| 2-794618-0 | 5-794618-0 |
| 2-794618-2 | 5-794618-2 |
| 2-794618-4 | 5-794618-4 |
| 794619-2 | 3-794619-2 |
| 794619-4 | 3-794619-4 |
| 794619-6 | 3-794619-6 |
| 794619-8 | 3-794619-8 |
| 1-794619-0 | 4-794619-0 |
| 1-794619-2 | 4-794619-2 |
| 1-794619-4 | 4-794619-4 |
| 1-794619-6 | 4-794619-6 |
| 1-794619-8 | 4-794619-8 |
| 2-794619-0 | 5-794619-0 |
| 2-794619-2 | 5-794619-2 |
| 2-794619-4 | 5-794619-4 |
| 794620-2 | 3-794620-2 |
| 794620-4 | 3-794620-4 |
| 794620-6 | 3-794620-6 |
| 794620-8 | 3-794620-8 |
| 1-794620-0 | 4-794620-0 |
| 1-794620-2 | 4-794620-2 |
| 1-794620-4 | 4-794620-4 |
| 1-794620-6 | 4-794620-6 |
| 1-794620-8 | 4-794620-8 |
| 2-794620-0 | 5-794620-0 |
| 2-794620-2 | 5-794620-2 |
| 2-794620-4 | 5-794620-4 |
| 794621-2 | 3-794621-2 |
| 794621-4 | 3-794621-4 |
| 794621-6 | 3-794621-6 |
| 794621-8 | 3-794621-8 |
| 1-794621-0 | 4-794621-0 |
| 1-794621-2 | 4-794621-2 |
| 1-794621-4 | 4-794621-4 |
| 1-794621-6 | 4-794621-6 |
| 1-794621-8 | 4-794621-8 |
| 2-794621-0 | 5-794621-0 |
| 2-794621-2 | 5-794621-2 |
| 2-794621-4 | 5-794621-4 |
| 794622-2 | 3-794622-2 |
| 794622-4 | 3-794622-4 |
| 794622-6 | 3-794622-6 |

Non-Compliant to RoHS Compliant Part Number Cross Reference

Non-Compliant to RoHS Compliant Part Number Cross Reference (Continued)

Non-Compliant to RoHS Compliant Part Number Cross Reference

| Non-Compliant Part Number | RoHS Compliant Part Number |
|---------------------------|----------------------------|
| 794622-8 | 3-794622-8 |
| 1-794622-0 | 4-794622-0 |
| 1-794622-2 | 4-794622-2 |
| 1-794622-4 | 4-794622-4 |
| 1-794622-6 | 4-794622-6 |
| 1-794622-8 | 4-794622-8 |
| 2-794622-0 | 5-794622-0 |
| 2-794622-2 | 5-794622-2 |
| 2-794622-4 | 5-794622-4 |
| 794623-2 | 3-794623-2 |
| 794623-4 | 3-794623-4 |
| 794623-6 | 3-794623-6 |
| 794623-8 | 3-794623-8 |
| 1-794623-0 | 4-794623-0 |
| 1-794623-2 | 4-794623-2 |
| 1-794623-4 | 4-794623-4 |
| 1-794623-6 | 4-794623-6 |
| 1-794623-8 | 4-794623-8 |
| 2-794623-0 | 5-794623-0 |
| 2-794623-2 | 5-794623-2 |
| 2-794623-4 | 5-794623-4 |
| 794624-2 | 3-794624-2 |
| 794624-4 | 3-794624-4 |
| 794624-6 | 3-794624-6 |
| 794624-8 | 3-794624-8 |
| 1-794624-0 | 4-794624-0 |
| 1-794624-2 | 4-794624-2 |
| 1-794624-4 | 4-794624-4 |
| 1-794624-6 | 4-794624-6 |
| 1-794624-8 | 4-794624-8 |
| 2-794624-0 | 5-794624-0 |
| 2-794624-2 | 5-794624-2 |
| 2-794624-4 | 5-794624-4 |
| 794625-2 | 3-794625-2 |
| 794625-4 | 3-794625-4 |
| 794625-6 | 3-794625-6 |
| 794625-8 | 3-794625-8 |
| 1-794625-0 | 4-794625-0 |
| 1-794625-2 | 4-794625-2 |
| 1-794625-4 | 4-794625-4 |
| 1-794625-6 | 4-794625-6 |
| 1-794625-8 | 4-794625-8 |
| 2-794625-0 | 5-794625-0 |
| 2-794625-2 | 5-794625-2 |
| 2-794625-4 | 5-794625-4 |
| 794626-2 | 3-794626-2 |
| 794626-4 | 3-794626-4 |
| 794626-6 | 3-794626-6 |
| 794626-8 | 3-794626-8 |
| 1-794626-0 | 4-794626-0 |
| 1-794626-2 | 4-794626-2 |
| 1-794626-4 | 4-794626-4 |
| 1-794626-6 | 4-794626-6 |
| 1-794626-8 | 4-794626-8 |
| 2-794626-0 | 5-794626-0 |
| 2-794626-2 | 5-794626-2 |
| 2-794626-4 | 5-794626-4 |
| 794627-2 | 3-794627-2 |
| 794627-4 | 3-794627-4 |
| 794627-6 | 3-794627-6 |
| 794627-8 | 3-794627-8 |

| Non-Compliant Part Number | RoHS Compliant Part Number |
|---------------------------|----------------------------|
| 1-794627-0 | 4-794627-0 |
| 1-794627-2 | 4-794627-2 |
| 1-794627-4 | 4-794627-4 |
| 1-794627-6 | 4-794627-6 |
| 1-794627-8 | 4-794627-8 |
| 2-794627-0 | 5-794627-0 |
| 2-794627-2 | 5-794627-2 |
| 2-794627-4 | 5-794627-4 |
| 794628-2 | 3-794628-2 |
| 794628-4 | 3-794628-4 |
| 794628-6 | 3-794628-6 |
| 794628-8 | 3-794628-8 |
| 1-794628-0 | 4-794628-0 |
| 1-794628-2 | 4-794628-2 |
| 1-794628-4 | 4-794628-4 |
| 1-794628-6 | 4-794628-6 |
| 1-794628-8 | 4-794628-8 |
| 2-794628-0 | 5-794628-0 |
| 2-794628-2 | 5-794628-2 |
| 2-794628-4 | 5-794628-4 |
| 794629-2 | 3-794629-2 |
| 794629-4 | 3-794629-4 |
| 794629-6 | 3-794629-6 |
| 794629-8 | 3-794629-8 |
| 1-794629-0 | 4-794629-0 |
| 1-794629-2 | 4-794629-2 |
| 1-794629-4 | 4-794629-4 |
| 1-794629-6 | 4-794629-6 |
| 1-794629-8 | 4-794629-8 |
| 2-794629-0 | 5-794629-0 |
| 2-794629-2 | 5-794629-2 |
| 2-794629-4 | 5-794629-4 |
| 794630-2 | 3-794630-2 |
| 794630-4 | 3-794630-4 |
| 794630-6 | 3-794630-6 |
| 794630-8 | 3-794630-8 |
| 1-794630-0 | 4-794630-0 |
| 1-794630-2 | 4-794630-2 |
| 1-794630-4 | 4-794630-4 |
| 1-794630-6 | 4-794630-6 |
| 1-794630-8 | 4-794630-8 |
| 2-794630-0 | 5-794630-0 |
| 2-794630-2 | 5-794630-2 |
| 2-794630-4 | 5-794630-4 |
| 794631-2 | 3-794631-2 |
| 794631-4 | 3-794631-4 |
| 794631-6 | 3-794631-6 |
| 794631-8 | 3-794631-8 |
| 1-794631-0 | 4-794631-0 |
| 1-794631-2 | 4-794631-2 |
| 1-794631-4 | 4-794631-4 |
| 1-794631-6 | 4-794631-6 |
| 1-794631-8 | 4-794631-8 |
| 2-794631-0 | 5-794631-0 |
| 2-794631-2 | 5-794631-2 |
| 2-794631-4 | 5-794631-4 |
| 794632-2 | 3-794632-2 |
| 794632-4 | 3-794632-4 |
| 794632-6 | 3-794632-6 |
| 794632-8 | 3-794632-8 |
| 1-794632-0 | 4-794632-0 |

| Non-Compliant Part Number | RoHS Compliant Part Number |
|---------------------------|----------------------------|
| 1-794632-2 | 4-794632-2 |
| 1-794632-4 | 4-794632-4 |
| 1-794632-6 | 4-794632-6 |
| 1-794632-8 | 4-794632-8 |
| 2-794632-0 | 5-794632-0 |
| 2-794632-2 | 5-794632-2 |
| 2-794632-4 | 5-794632-4 |
| 794633-2 | 3-794633-2 |
| 794633-4 | 3-794633-4 |
| 794633-6 | 3-794633-6 |
| 794633-8 | 3-794633-8 |
| 1-794633-0 | 4-794633-0 |
| 1-794633-2 | 4-794633-2 |
| 1-794633-4 | 4-794633-4 |
| 1-794633-6 | 4-794633-6 |
| 1-794633-8 | 4-794633-8 |
| 2-794633-0 | 5-794633-0 |
| 2-794633-2 | 5-794633-2 |
| 2-794633-4 | 5-794633-4 |
| 794634-2 | 3-794634-2 |
| 794634-4 | 3-794634-4 |
| 794634-6 | 3-794634-6 |
| 794634-8 | 3-794634-8 |
| 1-794634-0 | 4-794634-0 |
| 1-794634-2 | 4-794634-2 |
| 1-794634-4 | 4-794634-4 |
| 1-794634-6 | 4-794634-6 |
| 1-794634-8 | 4-794634-8 |
| 2-794634-0 | 5-794634-0 |
| 2-794634-2 | 5-794634-2 |
| 2-794634-4 | 5-794634-4 |
| 794635-2 | 3-794635-2 |
| 794635-4 | 3-794635-4 |
| 794635-6 | 3-794635-6 |
| 794635-8 | 3-794635-8 |
| 1-794635-0 | 4-794635-0 |
| 1-794635-2 | 4-794635-2 |
| 1-794635-4 | 4-794635-4 |
| 1-794635-6 | 4-794635-6 |
| 1-794635-8 | 4-794635-8 |
| 2-794635-0 | 5-794635-0 |
| 2-794635-2 | 5-794635-2 |
| 2-794635-4 | 5-794635-4 |
| 794636-2 | 3-794636-2 |
| 794636-4 | 3-794636-4 |
| 794636-6 | 3-794636-6 |
| 794636-8 | 3-794636-8 |
| 1-794636-0 | 4-794636-0 |
| 1-794636-2 | 4-794636-2 |
| 1-794636-4 | 4-794636-4 |
| 1-794636-6 | 4-794636-6 |
| 1-794636-8 | 4-794636-8 |
| 2-794636-0 | 5-794636-0 |
| 2-794636-2 | 5-794636-2 |
| 2-794636-4 | 5-794636-4 |
| 794637-2 | 3-794637-2 |
| 794637-4 | 3-794637-4 |
| 794637-6 | 3-794637-6 |
| 794637-8 | 3-794637-8 |
| 1-794637-0 | 4-794637-0 |
| 1-794637-2 | 4-794637-2 |

| Non-Compliant Part Number | RoHS Compliant Part Number |
|---------------------------|----------------------------|
| 1-794637-4 | 4-794637-4 |
| 1-794637-6 | 4-794637-6 |
| 1-794637-8 | 4-794637-8 |
| 2-794637-0 | 5-794637-0 |
| 2-794637-2 | 5-794637-2 |
| 2-794637-4 | 5-794637-4 |
| 794638-2 | 3-794638-2 |
| 794638-4 | 3-794638-4 |
| 794638-6 | 3-794638-6 |
| 794638-8 | 3-794638-8 |
| 1-794638-0 | 4-794638-0 |
| 1-794638-2 | 4-794638-2 |
| 1-794638-4 | 4-794638-4 |
| 1-794638-6 | 4-794638-6 |
| 1-794638-8 | 4-794638-8 |
| 2-794638-0 | 5-794638-0 |
| 2-794638-2 | 5-794638-2 |
| 2-794638-4 | 5-794638-4 |
| 794662-2 | 1586489-2 |
| 794662-4 | 1586489-4 |
| 794662-6 | 1586489-6 |
| 794662-8 | 1586489-8 |
| 1-794662-0 | 1-1586489-0 |
| 1-794662-2 | 1-1586489-2 |
| 1-794662-4 | 1-1586489-4 |
| 1-794662-6 | 1-1586489-6 |
| 1-794662-8 | 1-1586489-8 |
| 2-794662-0 | 2-1586489-0 |
| 2-794662-2 | 2-1586489-2 |
| 2-794662-4 | 2-1586489-4 |
| 794663-2 | 1586490-2 |
| 794663-4 | 1586490-4 |
| 794663-6 | 1586490-6 |
| 794663-8 | 1586490-8 |
| 1-794663-0 | 1-1586490-0 |
| 1-794663-2 | 1-1586490-2 |
| 1-794663-4 | 1-1586490-4 |
| 1-794663-6 | 1-1586490-6 |
| 1-794663-8 | 1-1586490-8 |
| 2-794663-0 | 2-1586490-0 |
| 2-794663-2 | 2-1586490-2 |
| 2-794663-4 | 2-1586490-4 |
| 794664-2 | 1586491-2 |
| 794664-4 | 1586491-4 |
| 794664-6 | 1586491-6 |
| 794664-8 | 1586491-8 |
| 1-794664-0 | 1-1586491-0 |
| 1-794664-2 | 1-1586491-2 |
| 1-794664-4 | 1-1586491-4 |
| 1-794664-6 | 1-1586491-6 |
| 1-794664-8 | 1-1586491-8 |
| 2-794664-0 | 2-1586491-0 |
| 2-794664-2 | 2-1586491-2 |
| 2-794664-4 | 2-1586491-4 |
| 794665-2 | 1586492-2 |
| 794665-4 | 1586492-4 |
| 794665-6 | 1586492-6 |
| 794665-8 | 1586492-8 |
| 1-794665-0 | 1-1586492-0 |
| 1-794665-2 | 1-1586492-2 |
| 1-794665-4 | 1-1586492-4 |

Non-Compliant to RoHS Compliant Part Number Cross Reference (Continued)

| Non-Compliant Part Number | RoHS Compliant Part Number |
|---------------------------|----------------------------|
| 1-794665-8 | 1-1586492-8 |
| 2-794665-0 | 2-1586492-0 |
| 2-794665-2 | 2-1586492-2 |
| 2-794665-4 | 2-1586492-4 |
| 794666-2 | 1586493-2 |
| 794666-4 | 1586493-4 |
| 794666-6 | 1586493-6 |
| 794666-8 | 1586493-8 |
| 1-794666-0 | 1-1586493-0 |
| 1-794666-2 | 1-1586493-2 |
| 1-794666-4 | 1-1586493-4 |
| 1-794666-6 | 1-1586493-6 |
| 1-794666-8 | 1-1586493-8 |
| 2-794666-0 | 2-1586493-0 |
| 2-794666-2 | 2-1586493-2 |
| 2-794666-4 | 2-1586493-4 |
| 794667-2 | 1586494-2 |
| 794667-4 | 1586494-4 |
| 794667-6 | 1586494-6 |
| 794667-8 | 1586494-8 |
| 1-794667-0 | 1-1586494-0 |
| 1-794667-2 | 1-1586494-2 |
| 1-794667-4 | 1-1586494-4 |
| 1-794667-6 | 1-1586494-6 |
| 1-794667-8 | 1-1586494-8 |
| 2-794667-0 | 2-1586494-0 |
| 2-794667-2 | 2-1586494-2 |
| 2-794667-4 | 2-1586494-4 |
| 794668-2 | 1586495-2 |
| 794668-4 | 1586495-4 |
| 794668-6 | 1586495-6 |
| 794668-8 | 1586495-8 |
| 1-794668-0 | 1-1586495-0 |
| 1-794668-2 | 1-1586495-2 |
| 1-794668-4 | 1-1586495-4 |
| 1-794668-6 | 1-1586495-6 |
| 1-794668-8 | 1-1586495-8 |
| 2-794668-0 | 2-1586495-0 |
| 2-794668-2 | 2-1586495-2 |
| 2-794668-4 | 2-1586495-4 |
| 794669-2 | 1586496-2 |
| 794669-4 | 1586496-4 |
| 794669-6 | 1586496-6 |
| 794669-8 | 1586496-8 |
| 1-794669-0 | 1-1586496-0 |
| 1-794669-2 | 1-1586496-2 |
| 1-794669-4 | 1-1586496-4 |
| 1-794669-6 | 1-1586496-6 |
| 1-794669-8 | 1-1586496-8 |
| 2-794669-0 | 2-1586496-0 |
| 2-794669-2 | 2-1586496-2 |
| 2-794669-4 | 2-1586496-4 |
| 794677-2 | 3-794677-2 |
| 794677-4 | 3-794677-4 |
| 794677-6 | 3-794677-6 |
| 794677-8 | 3-794677-8 |
| 1-794677-0 | 4-794677-0 |
| 1-794677-2 | 4-794677-2 |
| 1-794677-4 | 4-794677-4 |
| 1-794677-6 | 4-794677-6 |
| 1-794677-8 | 4-794677-8 |

| Non-Compliant Part Number | RoHS Compliant Part Number |
|---------------------------|----------------------------|
| 2-794677-0 | 5-794677-0 |
| 2-794677-2 | 5-794677-2 |
| 2-794677-4 | 5-794677-4 |
| 794678-2 | 3-794678-2 |
| 794678-4 | 3-794678-4 |
| 794678-6 | 3-794678-6 |
| 794678-8 | 3-794678-8 |
| 1-794678-0 | 4-794678-0 |
| 1-794678-2 | 4-794678-2 |
| 1-794678-4 | 4-794678-4 |
| 1-794678-6 | 4-794678-6 |
| 1-794678-8 | 4-794678-8 |
| 2-794678-0 | 5-794678-0 |
| 2-794678-2 | 5-794678-2 |
| 2-794678-4 | 5-794678-4 |
| 794679-2 | 3-794679-2 |
| 794679-4 | 3-794679-4 |
| 794679-6 | 3-794679-6 |
| 794679-8 | 3-794679-8 |
| 1-794679-0 | 4-794679-0 |
| 1-794679-2 | 4-794679-2 |
| 1-794679-4 | 4-794679-4 |
| 1-794679-6 | 4-794679-6 |
| 1-794679-8 | 4-794679-8 |
| 2-794679-0 | 5-794679-0 |
| 2-794679-2 | 5-794679-2 |
| 2-794679-4 | 5-794679-4 |
| 794680-2 | 3-794680-2 |
| 794680-4 | 3-794680-4 |
| 794680-6 | 3-794680-6 |
| 794680-8 | 3-794680-8 |
| 1-794680-0 | 4-794680-0 |
| 1-794680-2 | 4-794680-2 |
| 1-794680-4 | 4-794680-4 |
| 1-794680-6 | 4-794680-6 |
| 1-794680-8 | 4-794680-8 |
| 2-794680-0 | 5-794680-0 |
| 2-794680-2 | 5-794680-2 |
| 2-794680-4 | 5-794680-4 |
| 794681-2 | 3-794681-2 |
| 794681-4 | 3-794681-4 |
| 794681-6 | 3-794681-6 |
| 794681-8 | 3-794681-8 |
| 1-794681-0 | 4-794681-0 |
| 1-794681-2 | 4-794681-2 |
| 1-794681-4 | 4-794681-4 |
| 1-794681-6 | 4-794681-6 |
| 1-794681-8 | 4-794681-8 |
| 2-794681-0 | 5-794681-0 |
| 2-794681-2 | 5-794681-2 |
| 2-794681-4 | 5-794681-4 |
| 794682-2 | 3-794682-2 |
| 794682-4 | 3-794682-4 |
| 794682-6 | 3-794682-6 |
| 794682-8 | 3-794682-8 |
| 1-794682-0 | 4-794682-0 |
| 1-794682-2 | 4-794682-2 |
| 1-794682-4 | 4-794682-4 |
| 1-794682-6 | 4-794682-6 |
| 1-794682-8 | 4-794682-8 |
| 2-794682-0 | 5-794682-0 |

| Non-Compliant Part Number | RoHS Compliant Part Number |
|---------------------------|----------------------------|
| 2-794682-2 | 5-794682-2 |
| 2-794682-4 | 5-794682-4 |
| 794704-1 | 1586542-1 |
| 1445050-2 | 2-1445050-2 |
| 1445050-3 | 2-1445050-3 |
| 1445050-4 | 2-1445050-4 |
| 1445050-5 | 2-1445050-5 |
| 1445050-6 | 2-1445050-6 |
| 1445050-7 | 2-1445050-7 |
| 1445050-8 | 2-1445050-8 |
| 1445050-9 | 2-1445050-9 |
| 1-1445050-0 | 3-1445050-0 |
| 1-1445050-1 | 3-1445050-1 |
| 1-1445050-2 | 3-1445050-2 |
| 1445051-2 | 2-1445051-2 |
| 1445051-3 | 2-1445051-3 |
| 1445051-4 | 2-1445051-4 |
| 1445051-5 | 2-1445051-5 |
| 1445051-6 | 2-1445051-6 |
| 1445051-7 | 2-1445051-7 |
| 1445051-8 | 2-1445051-8 |
| 1445051-9 | 2-1445051-9 |
| 1-1445051-0 | 3-1445051-0 |
| 1-1445051-1 | 3-1445051-1 |
| 1-1445051-2 | 3-1445051-2 |
| 1445052-2 | 2-1445052-2 |
| 1445052-3 | 2-1445052-3 |
| 1445052-4 | 2-1445052-4 |
| 1445052-5 | 2-1445052-5 |
| 1445052-6 | 2-1445052-6 |
| 1445052-7 | 2-1445052-7 |
| 1445052-8 | 2-1445052-8 |
| 1445052-9 | 2-1445052-9 |
| 1-1445052-0 | 3-1445052-0 |
| 1-1445052-1 | 3-1445052-1 |
| 1-1445052-2 | 3-1445052-2 |
| 1445053-2 | 2-1445053-2 |
| 1445053-3 | 2-1445053-3 |
| 1445053-4 | 2-1445053-4 |
| 1445053-5 | 2-1445053-5 |
| 1445053-6 | 2-1445053-6 |
| 1445053-7 | 2-1445053-7 |
| 1445053-8 | 2-1445053-8 |
| 1445053-9 | 2-1445053-9 |
| 1-1445053-0 | 3-1445053-0 |
| 1-1445053-1 | 3-1445053-1 |
| 1-1445053-2 | 3-1445053-2 |
| 1445054-2 | 2-1445054-2 |
| 1445054-3 | 2-1445054-3 |
| 1445054-4 | 2-1445054-4 |
| 1445054-5 | 2-1445054-5 |
| 1445054-6 | 2-1445054-6 |
| 1445054-7 | 2-1445054-7 |
| 1445054-8 | 2-1445054-8 |
| 1445054-9 | 2-1445054-9 |
| 1-1445054-0 | 3-1445054-0 |
| 1-1445054-1 | 3-1445054-1 |
| 1-1445054-2 | 3-1445054-2 |
| 1445055-2 | 2-1445055-2 |
| 1445055-3 | 2-1445055-3 |
| 1445055-4 | 2-1445055-4 |

| Non-Compliant Part Number | RoHS Compliant Part Number |
|---------------------------|----------------------------|
| 1445055-5 | 2-1445055-5 |
| 1445055-6 | 2-1445055-6 |
| 1445055-7 | 2-1445055-7 |
| 1445055-8 | 2-1445055-8 |
| 1445055-9 | 2-1445055-9 |
| 1-1445055-0 | 3-1445055-0 |
| 1-1445055-1 | 3-1445055-1 |
| 1-1445055-2 | 3-1445055-2 |
| 1445056-2 | 2-1445056-2 |
| 1445056-3 | 2-1445056-3 |
| 1445056-4 | 2-1445056-4 |
| 1445056-5 | 2-1445056-5 |
| 1445056-6 | 2-1445056-6 |
| 1445056-7 | 2-1445056-7 |
| 1445056-8 | 2-1445056-8 |
| 1445056-9 | 2-1445056-9 |
| 1-1445056-0 | 3-1445056-0 |
| 1-1445056-1 | 3-1445056-1 |
| 1-1445056-2 | 3-1445056-2 |
| 1445057-2 | 2-1445057-2 |
| 1445057-3 | 2-1445057-3 |
| 1445057-4 | 2-1445057-4 |
| 1445057-5 | 2-1445057-5 |
| 1445057-6 | 2-1445057-6 |
| 1445057-7 | 2-1445057-7 |
| 1445057-8 | 2-1445057-8 |
| 1445057-9 | 2-1445057-9 |
| 1-1445057-0 | 3-1445057-0 |
| 1-1445057-1 | 3-1445057-1 |
| 1-1445057-2 | 3-1445057-2 |
| 1445058-2 | 2-1445058-2 |
| 1445058-3 | 2-1445058-3 |
| 1445058-4 | 2-1445058-4 |
| 1445058-5 | 2-1445058-5 |
| 1445058-6 | 2-1445058-6 |
| 1445058-7 | 2-1445058-7 |
| 1445058-8 | 2-1445058-8 |
| 1445058-9 | 2-1445058-9 |
| 1-1445058-0 | 3-1445058-0 |
| 1-1445058-1 | 3-1445058-1 |
| 1-1445058-2 | 3-1445058-2 |
| 1445084-2 | 2-1445084-2 |
| 1445084-3 | 2-1445084-3 |
| 1445084-4 | 2-1445084-4 |
| 1445084-5 | 2-1445084-5 |
| 1445084-6 | 2-1445084-6 |
| 1445084-7 | 2-1445084-7 |
| 1445084-8 | 2-1445084-8 |
| 1445084-9 | 2-1445084-9 |
| 1-1445084-0 | 3-1445084-0 |
| 1-1445084-1 | 3-1445084-1 |
| 1-1445084-2 | 3-1445084-2 |
| 1445085-2 | 2-1445085-2 |
| 1445085-3 | 2-1445085-3 |
| 1445085-4 | 2-1445085-4 |
| 1445085-5 | 2-1445085-5 |
| 1445085-6 | 2-1445085-6 |
| 1445085-7 | 2-1445085-7 |
| 1445085-8 | 2-1445085-8 |
| 1445085-9 | 2-1445085-9 |
| 1-1445085-0 | 3-1445085-0 |

Non-Compliant to RoHS Compliant Part Number Cross Reference

Non-Compliant to RoHS Compliant Part Number Cross Reference (Continued)

Non-Compliant to RoHS Compliant Part Number Cross Reference

| Non-Compliant Part Number | RoHS Compliant Part Number | Non-Compliant Part Number | RoHS Compliant Part Number | Non-Compliant Part Number | RoHS Compliant Part Number | Non-Compliant Part Number | RoHS Compliant Part Number |
|---------------------------|----------------------------|---------------------------|----------------------------|---------------------------|----------------------------|---------------------------|----------------------------|
| 1-1445085-1 | 3-1445085-1 | 1-1445089-2 | 3-1445089-2 | 1445094-2 | 2-1445094-2 | 1445098-3 | 2-1445098-3 |
| 1-1445085-2 | 3-1445085-2 | 1445090-2 | 2-1445090-2 | 1445094-3 | 2-1445094-3 | 1445098-4 | 2-1445098-4 |
| 1445086-2 | 2-1445086-2 | 1445090-3 | 2-1445090-3 | 1445094-4 | 2-1445094-4 | 1445098-5 | 2-1445098-5 |
| 1445086-3 | 2-1445086-3 | 1445090-4 | 2-1445090-4 | 1445094-5 | 2-1445094-5 | 1445098-6 | 2-1445098-6 |
| 1445086-4 | 2-1445086-4 | 1445090-5 | 2-1445090-5 | 1445094-6 | 2-1445094-6 | 1445098-7 | 2-1445098-7 |
| 1445086-5 | 2-1445086-5 | 1445090-6 | 2-1445090-6 | 1445094-7 | 2-1445094-7 | 1445098-8 | 2-1445098-8 |
| 1445086-6 | 2-1445086-6 | 1445090-7 | 2-1445090-7 | 1445094-8 | 2-1445094-8 | 1445098-9 | 2-1445098-9 |
| 1445086-7 | 2-1445086-7 | 1445090-8 | 2-1445090-8 | 1445094-9 | 2-1445094-9 | 1-1445098-0 | 3-1445098-0 |
| 1445086-8 | 2-1445086-8 | 1445090-9 | 2-1445090-9 | 1-1445094-0 | 3-1445094-0 | 1-1445098-1 | 3-1445098-1 |
| 1445086-9 | 2-1445086-9 | 1-1445090-0 | 3-1445090-0 | 1-1445094-1 | 3-1445094-1 | 1-1445098-2 | 3-1445098-2 |
| 1-1445086-0 | 3-1445086-0 | 1-1445090-1 | 3-1445090-1 | 1-1445094-2 | 3-1445094-2 | 1445099-2 | 2-1445099-2 |
| 1-1445086-1 | 3-1445086-1 | 1-1445090-2 | 3-1445090-2 | 1445095-2 | 2-1445095-2 | 1445099-3 | 2-1445099-3 |
| 1-1445086-2 | 3-1445086-2 | 1445091-2 | 2-1445091-2 | 1445095-3 | 2-1445095-3 | 1445099-4 | 2-1445099-4 |
| 1445087-2 | 2-1445087-2 | 1445091-3 | 2-1445091-3 | 1445095-4 | 2-1445095-4 | 1445099-5 | 2-1445099-5 |
| 1445087-3 | 2-1445087-3 | 1445091-4 | 2-1445091-4 | 1445095-5 | 2-1445095-5 | 1445099-6 | 2-1445099-6 |
| 1445087-4 | 2-1445087-4 | 1445091-5 | 2-1445091-5 | 1445095-6 | 2-1445095-6 | 1445099-7 | 2-1445099-7 |
| 1445087-5 | 2-1445087-5 | 1445091-6 | 2-1445091-6 | 1445095-7 | 2-1445095-7 | 1445099-8 | 2-1445099-8 |
| 1445087-6 | 2-1445087-6 | 1445091-7 | 2-1445091-7 | 1445095-8 | 2-1445095-8 | 1445099-9 | 2-1445099-9 |
| 1445087-7 | 2-1445087-7 | 1445091-8 | 2-1445091-8 | 1445095-9 | 2-1445095-9 | 1-1445099-0 | 3-1445099-0 |
| 1445087-8 | 2-1445087-8 | 1445091-9 | 2-1445091-9 | 1-1445095-0 | 3-1445095-0 | 1-1445099-1 | 3-1445099-1 |
| 1445087-9 | 2-1445087-9 | 1-1445091-0 | 3-1445091-0 | 1-1445095-1 | 3-1445095-1 | 1-1445099-2 | 3-1445099-2 |
| 1-1445087-0 | 3-1445087-0 | 1-1445091-1 | 3-1445091-1 | 1-1445095-2 | 3-1445095-2 | 1445100-2 | 2-1445100-2 |
| 1-1445087-1 | 3-1445087-1 | 1-1445091-2 | 3-1445091-2 | 1445096-2 | 2-1445096-2 | 1445100-3 | 2-1445100-3 |
| 1-1445087-2 | 3-1445087-2 | 1445092-2 | 2-1445092-2 | 1445096-3 | 2-1445096-3 | 1445100-4 | 2-1445100-4 |
| 1445088-2 | 2-1445088-2 | 1445092-3 | 2-1445092-3 | 1445096-4 | 2-1445096-4 | 1445100-5 | 2-1445100-5 |
| 1445088-3 | 2-1445088-3 | 1445092-4 | 2-1445092-4 | 1445096-5 | 2-1445096-5 | 1445100-6 | 2-1445100-6 |
| 1445088-4 | 2-1445088-4 | 1445092-5 | 2-1445092-5 | 1445096-6 | 2-1445096-6 | 1445100-7 | 2-1445100-7 |
| 1445088-5 | 2-1445088-5 | 1445092-6 | 2-1445092-6 | 1445096-7 | 2-1445096-7 | 1445100-8 | 2-1445100-8 |
| 1445088-6 | 2-1445088-6 | 1445092-7 | 2-1445092-7 | 1445096-8 | 2-1445096-8 | 1445100-9 | 2-1445100-9 |
| 1445088-7 | 2-1445088-7 | 1445092-8 | 2-1445092-8 | 1445096-9 | 2-1445096-9 | 1-1445100-0 | 3-1445100-0 |
| 1445088-8 | 2-1445088-8 | 1445092-9 | 2-1445092-9 | 1-1445096-0 | 3-1445096-0 | 1-1445100-1 | 3-1445100-1 |
| 1445088-9 | 2-1445088-9 | 1-1445092-0 | 3-1445092-0 | 1-1445096-1 | 3-1445096-1 | 1-1445100-2 | 3-1445100-2 |
| 1-1445088-0 | 3-1445088-0 | 1-1445092-1 | 3-1445092-1 | 1-1445096-2 | 3-1445096-2 | 1445101-2 | 2-1445101-2 |
| 1-1445088-1 | 3-1445088-1 | 1-1445092-2 | 3-1445092-2 | 1445097-2 | 2-1445097-2 | 1445101-3 | 2-1445101-3 |
| 1-1445088-2 | 3-1445088-2 | 1445093-2 | 2-1445093-2 | 1445097-3 | 2-1445097-3 | 1445101-4 | 2-1445101-4 |
| 1445089-2 | 2-1445089-2 | 1445093-3 | 2-1445093-3 | 1445097-4 | 2-1445097-4 | 1445101-5 | 2-1445101-5 |
| 1445089-3 | 2-1445089-3 | 1445093-4 | 2-1445093-4 | 1445097-5 | 2-1445097-5 | 1445101-6 | 2-1445101-6 |
| 1445089-4 | 2-1445089-4 | 1445093-5 | 2-1445093-5 | 1445097-6 | 2-1445097-6 | 1445101-7 | 2-1445101-7 |
| 1445089-5 | 2-1445089-5 | 1445093-6 | 2-1445093-6 | 1445097-7 | 2-1445097-7 | 1445101-8 | 2-1445101-8 |
| 1445089-6 | 2-1445089-6 | 1445093-7 | 2-1445093-7 | 1445097-8 | 2-1445097-8 | 1445101-9 | 2-1445101-9 |
| 1445089-7 | 2-1445089-7 | 1445093-8 | 2-1445093-8 | 1445097-9 | 2-1445097-9 | 1-1445101-0 | 3-1445101-0 |
| 1445089-8 | 2-1445089-8 | 1445093-9 | 2-1445093-9 | 1-1445097-0 | 3-1445097-0 | 1-1445101-1 | 3-1445101-1 |
| 1445089-9 | 2-1445089-9 | 1-1445093-0 | 3-1445093-0 | 1-1445097-1 | 3-1445097-1 | 1-1445101-2 | 3-1445101-2 |
| 1-1445089-0 | 3-1445089-0 | 1-1445093-1 | 3-1445093-1 | 1-1445097-2 | 3-1445097-2 | | |
| 1-1445089-1 | 3-1445089-1 | 1-1445093-2 | 3-1445093-2 | 1445098-2 | 2-1445098-2 | | |

Part Number Index (Continued)

| Part No. | Page | Part No. | Page | Part No. | Page | Part No. | Page |
|----------|----------------------------|----------|---------------------------------|----------|------------------------|----------|------------------------|
| 350561 | 172, 212 | 350779 | 171, 174, 182-185, 197-200 | 350990 | 171, 183 | 480705 | 171, 174 |
| 350570 | 172, 212 | 350780 | 171, 174 | 350991 | 171, 183 | 480706 | 171, 174, 182-183 |
| 350576 | 153, 162 | 350781 | 171, 174 | 350992 | 171, 183 | 480707 | 171, 174 |
| 350577 | 153, 162 | 350782 | 171, 174 | 353891 | 60, 78 | 480708 | 171, 174, 182-183 |
| 350578 | 153, 162 | 350783 | 171, 174 | 380935 | 116 | 480709 | 171, 174 |
| 350579 | 153, 162 | 350784 | 171, 174 | 380936 | 116 | 480710 | 171, 174, 182-183 |
| 350582 | 171, 182 | 350786 | 171, 182, 191, 197 | 380937 | 116 | 480711 | 171, 174 |
| 350583 | 171, 182 | 350787 | 171, 182, 191, 197 | 380991 | 153, 161 | 480720 | 153, 158, 161 |
| 350584 | 171, 182 | 350789 | 171, 182, 191, 197 | 380999 | 153, 161 | 480721 | 153, 158, 161 |
| 350585 | 171, 182 | 350790 | 171, 182, 191, 197 | 480270 | 153, 158, 160-161 | 480722 | 158, 161 |
| 350586 | 171, 182 | 350792 | 171, 182, 191, 197 | 480271 | 153, 160 | 480763 | 171, 174, 182-183, 185 |
| 350587 | 171, 182 | 350793 | 171, 182, 191, 197 | 480273 | 153, 159 | 480764 | 171, 174 |
| 350588 | 171, 182 | 350809 | 171, 174, 182-183, 185, 197-198 | 480274 | 153, 159 | 480772 | 154 |
| 350589 | 175 | 350810 | 171, 174, 193 | 480275 | 153, 159 | 640309 | 172 |
| 350590 | 173 | 350811 | 173 | 480276 | 153, 159, 162 | 640310 | 172 |
| 350591 | 112 | 350812 | 173 | 480277 | 153, 159, 162 | 640347 | 172 |
| 350628 | 55, 211 | 350824 | 171, 183, 191, 198 | 480278 | 153, 159, 162 | 640391 | 55, 211 |
| 350629 | 55, 211 | 350825 | 171, 183, 191, 198 | 480283 | 153, 158, 160-161 | 640392 | 55, 211 |
| 350638 | 155 | 350826 | 171, 183, 191, 198 | 480284 | 153, 160 | 640415 | 173 |
| 350639 | 155 | 350827 | 171, 183, 191, 198 | 480285 | 153, 158, 160-161 | 640466 | 171, 182 |
| 350641 | 153, 162 | 350828 | 171, 183, 191, 198 | 480286 | 153, 160 | 640467 | 171, 183 |
| 350642 | 153, 162 | 350829 | 171, 183, 191, 198 | 480287 | 153, 160-161 | 640497 | 105, 112 |
| 350643 | 153, 162 | 350830 | 171, 183, 191, 198 | 480288 | 153, 160 | 640498 | 105, 112 |
| 350644 | 153, 162 | 350831 | 171, 183, 191, 198 | 480303 | 153, 157, 161, 163 | 640499 | 105, 112 |
| 350654 | 173, 181, 213 | 350832 | 171, 183, 191, 198 | 480304 | 153, 159 | 640500 | 105, 112 |
| 350669 | 173, 181 | 350833 | 171, 183, 191, 198 | 480305 | 153, 157, 159 | 640501 | 105, 112 |
| 350687 | 173, 181, 213 | 350834 | 171, 183, 191, 198 | 480318 | 153, 157, 161, 163 | 640502 | 105, 112 |
| 350689 | 172 | 350835 | 171, 183, 191, 198 | 480319 | 153, 157 | 640503 | 105, 112 |
| 350690 | 172 | 350836 | 171, 183, 191, 198 | 480323 | 153, 159 | 640504 | 105, 112 |
| 350699 | 173, 213 | 350837 | 171, 183, 191, 198 | 480324 | 153, 159, 162 | 640505 | 105, 112 |
| 350700 | 173, 213 | 350838 | 112 | 480339 | 153, 158 | 640506 | 105, 112 |
| 350705 | 173, 181 | 350848 | 185 | 480340 | 153, 158 | 640507 | 105, 107 |
| 350706 | 173 | 350849 | 185 | 480345 | 153, 158 | 640508 | 105, 107 |
| 350707 | 173 | 350851 | 172, 212 | 480349 | 153, 157 | 640509 | 105, 107 |
| 350711 | 171, 182, 191, 197 | 350865 | 171, 174 | 480350 | 153, 157 | 640510 | 105, 107 |
| 350712 | 171, 182, 191, 197 | 350866 | 171, 174 | 480351 | 153, 157 | 640511 | 105, 108 |
| 350713 | 171, 182, 191, 197 | 350867 | 171, 174 | 480387 | 153, 157 | 640512 | 105, 108 |
| 350714 | 171, 182, 191, 197 | 350871 | 173 | 480388 | 153, 157 | 640513 | 105, 108 |
| 350715 | 171, 174, 182-183, 197-198 | 350873 | 172, 213 | 480393 | 153, 157 | 640514 | 105, 108 |
| 350720 | 171, 174, 182-183, 197-198 | 350874 | 172, 213 | 480400 | 153, 157 | 640515 | 105, 108 |
| 350732 | 171, 182, 191, 197 | 350877 | 173 | 480401 | 153, 157 | 640516 | 105, 108 |
| 350735 | 171, 174, 182-183, 197-198 | 350918 | 172 | 480424 | 154, 157, 165, 163-164 | 640517 | 105, 107, 112 |
| 350736 | 171, 174, 182-183, 197-198 | 350919 | 172 | 480425 | 154, 159 | 640518 | 105, 107, 112 |
| 350737 | 171, 182, 191, 197 | 350922 | 172, 213 | 480426 | 154, 157, 165, 162-163 | 640519 | 105, 107, 112 |
| 350738 | 171, 182, 191, 197 | 350923 | 172, 213 | 480438 | 153, 160-161 | 640520 | 105, 107, 112 |
| 350742 | 171, 182, 191, 197 | 350924 | 172, 212 | 480439 | 153, 160 | 640521 | 105, 108, 112 |
| 350759 | 171, 183 | 350925 | 172, 212 | 480498 | 153, 157 | 640522 | 105, 108, 112 |
| 350760 | 171, 183 | 350942 | 171, 183, 191, 200 | 480510 | 166 | 640523 | 105, 108, 112 |
| 350761 | 171, 183 | 350943 | 171, 183, 191, 200 | 480512 | 166 | 640524 | 105, 108, 112 |
| 350762 | 171, 183 | 350944 | 171, 183, 191, 200 | 480585 | 166 | 640525 | 105, 108, 112 |
| 350763 | 171, 183 | 350945 | 171, 183, 191, 200 | 480586 | 166 | 640526 | 105, 108, 112 |
| 350764 | 171, 183 | 350948 | 171, 185 | 480594 | 116 | 640545 | 112 |
| 350765 | 171, 183 | 350949 | 171, 185 | 480634 | 116 | 640579 | 112 |
| 350766 | 171, 174, 182-185, 197-200 | 350967 | 106, 205 | 480672 | 167 | 640580 | 112 |
| 350767 | 171, 174 | 350968 | 106, 205 | 480673 | 167 | 640581 | 171, 174, 182-183, 185 |
| 350777 | 171, 174, 182-185, 197-200 | 350969 | 106, 205 | 480698 | 171, 174, 182-184 | 640582 | 171, 174, 182, 185 |
| 350778 | 171, 174 | 350986 | 171, 183 | 480699 | 171, 174 | 640583 | 171, 185 |
| | | 350987 | 171, 183 | 480700 | 171, 174, 182-184 | 640584 | 171, 185 |
| | | 350988 | 171, 183 | 480701 | 171, 174 | 640585 | 171, 174, 182, 185 |
| | | 350989 | 171, 183 | 480702 | 171, 174, 182-185 | 640586 | 171, 174, 182, 185 |
| | | | | 480703 | 171, 174 | 640587 | 171, 185 |
| | | | | 480704 | 171, 174, 182-183 | 640713 | 180, 196 |

Part Number Index (Continued)

| Part No. | Page |
|----------|--------------------|
| 640714 | 180, 196 |
| 640715 | 180, 196 |
| 640716 | 180, 196 |
| 640717 | 180, 196 |
| 640718 | 180, 196 |
| 640719 | 176 |
| 640720 | 176 |
| 640721 | 176 |
| 640722 | 176 |
| 640723 | 176 |
| 640724 | 176 |
| 640900 | 171, 182, 191, 197 |
| 640901 | 171, 183, 191, 198 |
| 641083 | 171 |
| 641294 | 106, 205 |
| 641300 | 112 |
| 641737 | 154, 163 |
| 641763 | 176 |
| 641775 | 176 |
| 641776 | 180, 196 |
| 641777 | 176 |
| 641778 | 176 |
| 641825 | 171, 182 |
| 641828 | 171, 182 |
| 641831 | 171, 182 |
| 641832 | 171, 182 |
| 641945 | 180, 196 |
| 641963 | 171, 182 |
| 641964 | 171, 182, 191, 197 |
| 641965 | 171, 182 |
| 641966 | 171, 182, 191, 197 |
| 641967 | 171, 182 |
| 641968 | 171, 182, 191, 197 |
| 641969 | 171, 182 |
| 641970 | 171, 182, 191, 197 |
| 641971 | 171, 182 |
| 641972 | 171, 182, 191, 197 |
| 641973 | 171, 182 |
| 641974 | 171, 182, 191, 197 |
| 641975 | 171, 182 |
| 641976 | 171, 182, 191, 197 |
| 643030 | 180, 196 |
| 643182 | 176 |
| 643226 | 171, 183, 191, 200 |
| 643228 | 171, 183, 191, 200 |
| 643230 | 171, 183, 191, 200 |
| 643232 | 171, 183, 191, 200 |
| 643234 | 171, 185 |
| 643235 | 185 |
| 643236 | 171, 185 |
| 643237 | 185 |
| 643313 | 176 |
| 643314 | 176 |
| 643405 | 171, 182 |
| 643406 | 171, 182, 191, 197 |
| 643407 | 171, 182 |
| 643408 | 171, 182 |
| 643410 | 171, 182 |
| 643411 | 171, 183 |
| 643412 | 171, 183, 191, 198 |
| 643413 | 171, 183 |
| 643414 | 171, 183, 191, 198 |

| Part No. | Page |
|----------|--------------------------------------|
| 643415 | 171, 183 |
| 643416 | 171, 183, 191, 198 |
| 643423 | 171, 183 |
| 643424 | 171, 183, 191, 198 |
| 643425 | 171, 183 |
| 643426 | 171, 183, 191, 198 |
| 643428 | 171, 183, 191, 198 |
| 643429 | 171, 183 |
| 643430 | 171, 183, 191, 198 |
| 643488 | 153, 163 |
| 643585 | 176 |
| 643749 | 182 |
| 770003 | 192, 213 |
| 770004 | 192, 213 |
| 770005 | 192, 213 |
| 770006 | 192, 213 |
| 770007 | 192, 213 |
| 770008 | 192, 213 |
| 770009 | 192, 213 |
| 770010 | 192, 213 |
| 770011 | 192, 213 |
| 770012 | 192, 213 |
| 770016 | 194-195, 185, 191, 193, 195, 197-198 |
| 770017 | 194-195, 191, 193, 195, 197-201 |
| 770018 | 194-195, 191, 193, 195, 197-201 |
| 770019 | 194-195, 191, 193, 195, 197-1201 |
| 770020 | 194-195, 191, 194-195, 197-198, 201 |
| 770021 | 194-195, 191, 194-195, 197-198, 201 |
| 770022 | 194-195, 191, 194-195, 197-198, 201 |
| 770023 | 194-195, 191, 194-195, 197-198, 201 |
| 770024 | 191, 193, 195, 201 |
| 770025 | 191, 193, 195, 201 |
| 770026 | 191, 193, 195, 201 |
| 770027 | 191, 194-195, 201 |
| 770028 | 191, 194-195, 201 |
| 770029 | 191, 194-195, 201 |
| 770030 | 191, 194-195, 201 |
| 770031 | 195 |
| 770032 | 195 |
| 770033 | 195 |
| 770034 | 195 |
| 770035 | 195 |
| 770036 | 195 |
| 770037 | 195 |
| 770038 | 195 |
| 770039 | 195 |
| 770040 | 195 |
| 770041 | 195 |
| 770042 | 195 |
| 770043 | 195 |
| 770044 | 195 |
| 770045 | 195 |
| 770046 | 195 |
| 770047 | 195 |
| 770048 | 195 |
| 770049 | 195 |

| Part No. | Page |
|----------|------------------|
| 770050 | 195 |
| 770051 | 195 |
| 770052 | 195 |
| 770053 | 195 |
| 770054 | 195 |
| 770055 | 195 |
| 770056 | 195 |
| 770057 | 195 |
| 770058 | 195 |
| 770063 | 146 |
| 770064 | 146 |
| 770065 | 146 |
| 770066 | 146 |
| 770068 | 146 |
| 770069 | 146 |
| 770070 | 146 |
| 770071 | 146 |
| 770073 | 146 |
| 770074 | 146 |
| 770075 | 146 |
| 770076 | 146 |
| 770077 | 146 |
| 770078 | 146 |
| 770083 | 146 |
| 770084 | 146 |
| 770085 | 146 |
| 770086 | 146 |
| 770087 | 146 |
| 770088 | 146 |
| 770089 | 146 |
| 770090 | 146 |
| 770091 | 146 |
| 770092 | 146 |
| 770093 | 146 |
| 770094 | 146 |
| 770095 | 146 |
| 770096 | 146 |
| 770097 | 146 |
| 770098 | 146 |
| 770099 | 146 |
| 770100 | 146 |
| 770101 | 146 |
| 770102 | 146 |
| 770103 | 146 |
| 770105 | 146 |
| 770106 | 146 |
| 770107 | 146 |
| 770108 | 146 |
| 770143 | 171, 182 |
| 770144 | 145 |
| 770145 | 145 |
| 770146 | 145 |
| 770147 | 145 |
| 770156 | 154, 163 |
| 770166 | 85, 90, 103, 107 |
| 770170 | 85, 90, 103, 107 |
| 770174 | 85, 90, 103, 107 |
| 770178 | 85, 90, 103, 107 |
| 770182 | 85, 90, 103, 107 |
| 770186 | 85, 90, 103, 107 |
| 770190 | 85, 90, 103, 107 |
| 770193 | 192, 213 |

| Part No. | Page |
|----------|----------|
| 770194 | 192, 213 |
| 770210 | 173, 213 |
| 770232 | 163 |
| 770233 | 163 |
| 770234 | 173, 213 |
| 770246 | 192 |
| 770247 | 192 |
| 770248 | 192 |
| 770249 | 192 |
| 770250 | 192 |
| 770251 | 192 |
| 770252 | 192 |
| 770253 | 192 |
| 770254 | 192 |
| 770255 | 192 |
| 770262 | 171, 183 |
| 770264 | 146 |
| 770266 | 146 |
| 770269 | 148 |
| 770272 | 182 |
| 770274 | 56 |
| 770275 | 56 |
| 770276 | 148 |
| 770277 | 56 |
| 770278 | 56 |
| 770319 | 195 |
| 770320 | 195 |
| 770326 | 56 |
| 770329 | 148 |
| 770330 | 148 |
| 770331 | 56 |
| 770332 | 56 |
| 770333 | 56 |
| 770334 | 56 |
| 770335 | 56 |
| 770336 | 148 |
| 770337 | 148 |
| 770338 | 148 |
| 770339 | 148 |
| 770340 | 56 |
| 770341 | 56 |
| 770342 | 56 |
| 770343 | 56 |
| 770351 | 182 |
| 770353 | 56 |
| 770354 | 56 |
| 770355 | 56 |
| 770356 | 56 |
| 770360 | 148 |
| 770361 | 148 |
| 770364 | 145, 149 |
| 770365 | 145, 149 |
| 770372 | 148 |
| 770373 | 148 |
| 770377 | 180, 196 |
| 770383 | 145, 212 |
| 770385 | 145, 212 |
| 770416 | 192 |
| 770419 | 56 |
| 770421 | 171, 174 |
| 770424 | 149 |
| 770425 | 149 |

Part Number Index (Continued)

| Part No. | Page |
|----------|--------------------------|
| 770426 | 56 |
| 770427 | 56 |
| 770428 | 56 |
| 770429 | 56 |
| 770433 | 56 |
| 770441 | 56 |
| 770442 | 56 |
| 770443 | 56 |
| 770450 | 145, 149 |
| 770451 | 145, 149 |
| 770452 | 145, 149 |
| 770453 | 145, 149 |
| 770512 | 192 |
| 770526 | 154 |
| 770529 | 145, 212 |
| 770530 | 145, 212 |
| 770579 | 85, 88, 90-93, 103-106 |
| 770580 | 85, 88, 90-93, 103-106 |
| 770581 | 85, 88, 90, 92, 103, 105 |
| 770582 | 85, 88, 90, 92, 103, 105 |
| 770583 | 85, 88, 90, 92, 103, 105 |
| 770584 | 85, 88, 90, 92, 103, 105 |
| 770585 | 85, 88, 90, 92, 103, 105 |
| 770586 | 85, 88, 90, 92, 103, 105 |
| 770587 | 85, 88, 90, 92, 103, 105 |
| 770621 | 85, 90, 103, 107 |
| 770672 | 172 |
| 770673 | 172 |
| 770743 | 85, 90, 103, 107 |
| 770771 | 148 |
| 770782 | 146 |
| 770783 | 149 |
| 770784 | 149 |
| 770785 | 149 |
| 770810 | 149 |
| 770827 | 154, 157, 163 |
| 770829 | 154, 162-163 |
| 770834 | 85, 211 |
| 770835 | 85, 211 |
| 770842 | 146 |
| 770843 | 146 |
| 770846 | 154, 163 |
| 770858 | 85, 90, 103, 107 |
| 770859 | 85, 90, 103, 107 |
| 770872 | 85, 90, 103, 107 |
| 770872 | 97 |
| 770873 | 85, 90, 103, 107 |
| 770874 | 85, 90, 103, 107 |
| 770875 | 85, 90, 103, 107 |
| 770876 | 85, 90, 103, 107 |
| 770892 | 146 |
| 770901 | 86, 96, 211 |
| 770902 | 86, 96, 211 |
| 770903 | 86, 96, 211 |
| 770904 | 86, 96, 211 |
| 770966 | 85, 91, 105, 107 |
| 770967 | 85, 91, 105, 107 |
| 770968 | 85, 91, 105, 107 |
| 770969 | 85, 91, 105, 107 |
| 770970 | 85, 91, 105, 107 |
| 770971 | 85, 91, 105, 107 |
| 770972 | 85, 91, 105, 107 |

| Part No. | Page |
|----------|----------------------------|
| 770973 | 85, 91, 105, 107 |
| 770974 | 85, 91, 105, 107 |
| 770983 | 53, 55 |
| 770985 | 85, 96 |
| 770986 | 85, 96 |
| 770987 | 85, 96 |
| 770988 | 85, 96 |
| 770994 | 185 |
| 770997 | 154, 162 |
| 794000 | 106, 205 |
| 794001 | 112 |
| 794012 | 153, 158 |
| 794015 | 146 |
| 794016 | 55 |
| 794017 | 55 |
| 794018 | 55 |
| 794019 | 55 |
| 794036 | 154, 163 |
| 794040 | 85, 90, 103, 107 |
| 794046 | 55, 211 |
| 794058 | 86 |
| 794059 | 86 |
| 794061 | 167 |
| 794065 | 85, 90, 103, 107 |
| 794066 | 85, 90, 103, 107 |
| 794067 | 85, 90, 103, 107 |
| 794068 | 85, 90, 103, 107 |
| 794069 | 85, 90, 103, 107 |
| 794070 | 85, 90, 103, 107 |
| 794071 | 85, 90, 103, 107 |
| 794072 | 85, 90, 103, 107 |
| 794073 | 85, 90, 103, 107 |
| 794074 | 85, 90, 103, 107 |
| 794075 | 85, 90, 103, 107 |
| 794076 | 85, 90, 103, 107 |
| 794077 | 85, 90, 103, 107 |
| 794078 | 85, 90, 103, 107 |
| 794079 | 85, 90, 103, 107 |
| 794096 | 171, 174 |
| 794103 | 55, 211 |
| 794105 | 85, 91, 105, 107 |
| 794106 | 85, 91, 105, 107 |
| 794107 | 85, 91, 105, 107 |
| 794108 | 85, 91, 105, 107 |
| 794116 | 214 |
| 794117 | 214 |
| 794118 | 214 |
| 794120 | 153, 163 |
| 794132 | 154, 157 |
| 794138 | 126, 212 |
| 794139 | 126, 212 |
| 794140 | 126, 212 |
| 794141 | 126 |
| 794142 | 126 |
| 794143 | 126 |
| 794184 | 90, 92, 101, 103, 105, 107 |
| 794185 | 101, 107 |
| 794186 | 90, 92, 101, 103, 105, 107 |
| 794187 | 101, 107 |
| 794188 | 90-92, 99, 101-102, 107 |

| Part No. | Page |
|----------|---------------------------|
| 794189 | 101, 107 |
| 794190 | 90-92, 99, 101-102, 107 |
| 794191 | 101, 107 |
| 794192 | 90-91, 100-101, 105, 107 |
| 794193 | 101, 107 |
| 794194 | 90-91, 100-102, 107 |
| 794195 | 101, 107 |
| 794196 | 90-91, 100-105, 107 |
| 794197 | 101, 107 |
| 794198 | 90, 92, 100-101, 105, 107 |
| 794199 | 101, 107 |
| 794200 | 90-91, 100-102, 107 |
| 794201 | 101, 107 |
| 794202 | 90, 92, 100-101, 105, 107 |
| 794203 | 101, 107 |
| 794204 | 90-91, 100-102, 107 |
| 794205 | 101, 107 |
| 794206 | 90, 92, 100-101, 105, 107 |
| 794207 | 101, 107 |
| 794208 | 90, 92, 100-101, 105, 107 |
| 794209 | 101, 107 |
| 794210 | 90, 92, 100-101, 105, 107 |
| 794211 | 101, 107 |
| 794212 | 90, 92, 100-101, 105, 107 |
| 794213 | 101, 107 |
| 794214 | 90, 92, 100-101, 105, 107 |
| 794215 | 101, 107 |
| 794216 | 100, 211 |
| 794217 | 100, 211 |
| 794218 | 100, 211 |
| 794219 | 100, 211 |
| 794220 | 100, 211 |
| 794221 | 100, 211 |
| 794222 | 100, 211 |
| 794223 | 100, 211 |
| 794224 | 100 |
| 794225 | 100 |
| 794226 | 100 |
| 794227 | 100 |
| 794228 | 100 |
| 794229 | 100 |
| 794230 | 100 |
| 794231 | 100 |
| 794236 | 154, 161 |
| 794237 | 101, 107 |
| 794238 | 101, 107 |
| 794239 | 101, 107 |
| 794240 | 101, 107 |
| 794241 | 101, 107 |
| 794242 | 101, 107 |
| 794243 | 101, 107 |
| 794244 | 101, 107 |
| 794245 | 101, 107 |
| 794246 | 101, 107 |
| 794247 | 101, 107 |
| 794248 | 101, 107 |
| 794249 | 101, 107 |

| Part No. | Page |
|----------|------------------|
| 794250 | 101, 107 |
| 794251 | 101, 107 |
| 794252 | 101, 107 |
| 794253 | 101, 107 |
| 794254 | 101, 107 |
| 794255 | 101, 107 |
| 794256 | 101, 107 |
| 794257 | 101, 107 |
| 794258 | 101, 107 |
| 794259 | 101, 107 |
| 794260 | 101, 107 |
| 794261 | 101, 107 |
| 794262 | 101, 107 |
| 794263 | 101, 107 |
| 794264 | 101, 107 |
| 794265 | 101, 107 |
| 794266 | 101, 107 |
| 794267 | 101, 107 |
| 794268 | 101, 107 |
| 794269 | 179 |
| 794270 | 179 |
| 794271 | 179 |
| 794272 | 179 |
| 794273 | 179 |
| 794274 | 179 |
| 794275 | 179 |
| 794276 | 179 |
| 794277 | 179 |
| 794278 | 179 |
| 794279 | 179 |
| 794280 | 179 |
| 794281 | 179 |
| 794282 | 179 |
| 794285 | 162 |
| 794287 | 154, 162 |
| 794302 | 128 |
| 794303 | 128 |
| 794304 | 128 |
| 794305 | 129 |
| 794306 | 129 |
| 794307 | 130 |
| 794308 | 130 |
| 794309 | 131 |
| 794310 | 131 |
| 794311 | 132 |
| 794312 | 132 |
| 794313 | 133 |
| 794325 | 85, 90, 104, 107 |
| 794326 | 85, 90, 104, 107 |
| 794327 | 85, 90, 104, 107 |
| 794328 | 85, 90, 104, 107 |
| 794329 | 85, 90, 104, 107 |
| 794330 | 85, 90, 104, 107 |
| 794349 | 128 |
| 794350 | 128 |
| 794351 | 128 |
| 794352 | 129 |
| 794353 | 129 |
| 794354 | 130 |
| 794355 | 130 |
| 794356 | 131 |
| 794357 | 131 |

Part Number Index (Continued)

| Part No. | Page | Part No. | Page | Part No. | Page | Part No. | Page |
|----------|------------------|----------|--------------------------|----------|------------|----------|---------------|
| 794358 | 132 | 794538 | 171 | 794707 | 171 | 917696 | 10, 12-13 |
| 794359 | 132 | 794540 | 128 | 794714 | 177 | 917697 | 10, 12-13 |
| 794360 | 133 | 794542 | 127 | 794715 | 177 | 917698 | 10, 12 |
| 794369 | 101 | 794543 | 128 | 794716 | 177 | 917699 | 10, 12 |
| 794370 | 94 | 794545 | 171 | 794727 | 171 | 917700 | 10, 12 |
| 794374 | 85, 92 | 794546 | 171 | 794758 | 96 | 917701 | 10, 12 |
| 794380 | 53, 55 | 794550 | 127 | 794760 | 177 | 917702 | 10, 12 |
| 794406 | 86 | 794576 | 121, 206 | 794761 | 177 | 917703 | 10, 12 |
| 794407 | 86 | 794577 | 127 | 794762 | 177 | 917704 | 10, 12 |
| 794412 | 214 | 794578 | 121, 206 | 794772 | 96 | 917705 | 10, 12 |
| 794413 | 214 | 794579 | 127 | 794772 | 97 | 917706 | 10, 12 |
| 794415 | 132 | 794588 | 133 | 794781 | 85, 96 | 917707 | 10, 12 |
| 794418 | 126, 212 | 794589 | 133 | 794781 | 97 | 917708 | 10, 12 |
| 794421 | 126 | 794590 | 133 | 794805 | 85, 96 | 917709 | 10, 12 |
| 794423 | 94 | 794594 | 127 | 794805 | 97 | 917722 | 10, 16 |
| 794429 | 131 | 794598 | 127 | 794814 | 171 | 917723 | 10, 16 |
| 794432 | 85, 90, 104, 107 | 794606 | 19-22, 211 | 794815 | 171 | 917724 | 10, 16 |
| 794448 | 133 | 794606 | 20 | 794821 | 85, 96 | 917725 | 10, 16 |
| 794449 | 133 | 794607 | 19-22, 211 | 794821 | 97 | 917726 | 10, 16 |
| 794453 | 130 | 794608 | 19, 22, 211 | 794824 | 96 | 917727 | 10, 16 |
| 794454 | 131 | 794609 | 19, 22, 211 | 794824 | 97 | 917728 | 10, 16 |
| 794455 | 132 | 794610 | 19-22 | 794851 | 171 | 917729 | 10, 16 |
| 794466 | 128 | 794610 | 20 | 794863 | 171 | 917730 | 10, 16 |
| 794467 | 128 | 794611 | 19-22 | 794894 | 85, 96 | 917731 | 10, 16 |
| 794468 | 129 | 794611 | 20 | 794894 | 97 | 917732 | 10, 16 |
| 794469 | 129 | 794612 | 19, 22 | 794895 | 85, 96 | 917733 | 10, 16 |
| 794470 | 130 | 794613 | 19, 22 | 794896 | 85, 96 | 917745 | 61, 79 |
| 794471 | 132 | 794615 | 19, 28 | 794899 | 171 | 917746 | 79 |
| 794472 | 133 | 794616 | 19, 27 | 794900 | 171 | 917747 | 80 |
| 794484 | 128 | 794617 | 19, 21, 24, 34-37, 43-47 | 794901 | 171 | 917764 | 12, 14, 205 |
| 794485 | 128 | | | 794911 | 191 | 917765 | 12, 14, 205 |
| 794486 | 129 | 794618 | 21, 44 | 794912 | 191 | 917780 | 10, 15 |
| 794487 | 129 | 794619 | 21, 44 | 794939 | 85, 96 | 917781 | 10, 15 |
| 794488 | 130 | 794620 | 21, 44 | 794940 | 85, 96 | 917782 | 10, 15 |
| 794489 | 130 | 794621 | 21, 46 | 794941 | 85, 96 | 917783 | 10, 15 |
| 794490 | 131 | 794622 | 21, 46 | 794942 | 85, 96 | 917784 | 10, 15 |
| 794491 | 131 | 794623 | 21, 46 | 794953 | 122 | 917785 | 10, 15 |
| 794492 | 132 | 794624 | 21, 45 | 794954 | 122 | 917786 | 10, 15 |
| 794493 | 132 | 794625 | 21, 45 | 794955 | 114, 206 | 917787 | 10, 15 |
| 794494 | 133 | 794626 | 21, 45 | 794956 | 114, 206 | 917788 | 10, 15 |
| 794507 | 133 | 794627 | 21, 47 | 794957 | 114, 206 | 917789 | 10, 15 |
| 794508 | 133 | 794628 | 21, 47 | 794958 | 114, 206 | 917790 | 10, 15 |
| 794509 | 133 | 794629 | 21, 47 | 794991 | 180 | 917791 | 10, 15 |
| 794510 | 133 | 794630 | 21, 34 | 794992 | 180 | 917845 | 61, 73 |
| 794511 | 133 | 794631 | 21, 34 | 794993 | 180 | 917894 | 15 |
| 794512 | 133 | 794632 | 21, 34 | 794994 | 180 | 917895 | 15 |
| 794513 | 133 | 794633 | 21, 36 | 794995 | 96 | 917896 | 15 |
| 794514 | 133 | 794634 | 21, 36 | 797607 | 20 | 917897 | 15 |
| 794515 | 133 | 794635 | 21, 36 | 917353 | 61, 81 | 917898 | 15 |
| 794516 | 133 | 794636 | 21, 37 | 917354 | 61, 76-77 | 917899 | 15 |
| 794526 | 133 | 794637 | 21, 37 | 917683 | 12-13, 205 | 917900 | 15 |
| 794527 | 133 | 794638 | 21, 37 | 917684 | 12-13, 205 | 926302 | 171, 174 |
| 794528 | 133 | 794657 | 126 | 917686 | 10, 12-13 | 926307 | 171, 174 |
| 794529 | 133 | 794677 | 21, 43 | 917687 | 10, 12-13 | 926308 | 171, 174 |
| 794530 | 133 | 794678 | 21, 43 | 917688 | 10, 12-13 | 926309 | 171, 174 |
| 794531 | 133 | 794679 | 21, 43 | 917689 | 10, 12-13 | 1375618 | 126-127 |
| 794532 | 133 | 794680 | 21, 35 | 917690 | 10, 12-13 | 1376294 | 136 |
| 794533 | 133 | 794681 | 21, 35 | 917691 | 10, 12-13 | 1376347 | 137, 212 |
| 794534 | 133 | 794682 | 21, 35 | 917692 | 10, 12-13 | 1376348 | 137, 212 |
| 794535 | 171 | 794683 | 167 | 917693 | 10, 12-13 | 1376382 | 136, 138, 140 |
| 794536 | 171 | 794699 | 167 | 917694 | 10, 12-13 | 1376383 | 136, 138, 140 |
| 794537 | 171 | 794700 | 166 | 917695 | 10, 12-13 | 1376384 | 136, 138, 140 |

Part Number Index (Continued)

| Part No. | Page |
|----------|-------------------------|
| 1376385 | 136, 138, 140 |
| 1376386 | 136, 139, 141 |
| 1376387 | 136, 139, 141 |
| 1376388 | 136-138, 140 |
| 1376389 | 136-138, 140 |
| 1376390 | 136-138, 140 |
| 1376391 | 136-138, 140 |
| 1376392 | 136, 139, 141 |
| 1376393 | 136, 139, 141 |
| 1376394 | 136-139 |
| 1376395 | 136-139 |
| 1376396 | 136-138 |
| 1376397 | 136-138 |
| 1376421 | 136, 138, 140 |
| 1376437 | 140 |
| 1376439 | 140 |
| 1376440 | 140 |
| 1376441 | 140 |
| 1376442 | 140 |
| 1376443 | 140 |
| 1376444 | 140 |
| 1445022 | 19-20, 23, 30-33, 38-42 |
| 1445048 | 19, 26 |
| 1445049 | 19, 25 |
| 1445050 | 20, 30 |
| 1445051 | 20, 31 |
| 1445052 | 20, 32 |
| 1445053 | 20, 33 |
| 1445054 | 20, 38 |
| 1445055 | 20, 39 |
| 1445056 | 20, 40 |
| 1445057 | 20, 41 |
| 1445058 | 20, 42 |
| 1445084 | 20, 30 |
| 1445085 | 20, 31 |
| 1445086 | 20, 32 |

| Part No. | Page |
|----------|---------|
| 1445087 | 20, 33 |
| 1445088 | 20, 38 |
| 1445089 | 20, 39 |
| 1445090 | 20, 40 |
| 1445091 | 20, 41 |
| 1445092 | 20, 42 |
| 1445093 | 20, 30 |
| 1445094 | 20, 31 |
| 1445095 | 20, 32 |
| 1445096 | 20, 33 |
| 1445097 | 20, 38 |
| 1445098 | 20, 39 |
| 1445099 | 20, 40 |
| 1445100 | 20, 41 |
| 1445101 | 20, 42 |
| 1565079 | 50, 211 |
| 1565080 | 50, 211 |
| 1565081 | 51 |
| 1565082 | 51 |
| 1565083 | 52 |
| 1565084 | 52 |
| 1565085 | 51 |
| 1565086 | 51 |
| 1565087 | 52 |
| 1565088 | 52 |
| 1586000 | 122 |
| 1586017 | 122 |
| 1586018 | 122 |
| 1586019 | 122 |
| 1586022 | 121 |
| 1586023 | 121 |
| 1586024 | 121 |
| 1586025 | 121 |
| 1586026 | 121 |
| 1586027 | 121 |
| 1586037 | 123 |

| Part No. | Page |
|----------|----------|
| 1586038 | 123 |
| 1586039 | 123 |
| 1586040 | 123 |
| 1586041 | 123 |
| 1586042 | 123 |
| 1586043 | 123 |
| 1586044 | 123 |
| 1586101 | 121 |
| 1586102 | 121 |
| 1586103 | 121 |
| 1586104 | 121 |
| 1586105 | 121 |
| 1586106 | 121 |
| 1586305 | 167 |
| 1586314 | 121 |
| 1586315 | 121 |
| 1586316 | 121 |
| 1586317 | 121 |
| 1586359 | 97 |
| 1586359 | 96 |
| 1586362 | 96 |
| 1586362 | 97 |
| 1586404 | 96 |
| 1586489 | 128-133 |
| 1586490 | 128-133 |
| 1586491 | 128-133 |
| 1586492 | 128-133 |
| 1586493 | 128-133 |
| 1586494 | 128-133 |
| 1586495 | 128-133 |
| 1586496 | 128-133 |
| 1586512 | 153, 161 |
| 1586514 | 153, 161 |
| 1586515 | 154, 161 |
| 1586518 | 153, 161 |
| 1586520 | 153, 161 |

| Part No. | Page |
|----------|------------|
| 1586522 | 153, 161 |
| 1586524 | 153, 161 |
| 1586525 | 154, 161 |
| 1586526 | 153, 161 |
| 1586528 | 153, 161 |
| 1586529 | 153, 161 |
| 1586530 | 153, 161 |
| 1586532 | 153, 161 |
| 1586534 | 154, 161 |
| 1586536 | 154, 161 |
| 1586539 | 162 |
| 1586544 | 153, 161 |
| 1586546 | 153, 161 |
| 1586585 | 124 |
| 1586586 | 124 |
| 1586587 | 124 |
| 1586588 | 124 |
| 1586627 | 161 |
| 1604210 | 178 |
| 1604254 | 178 |
| 1604256 | 178 |
| 1604941 | 178 |
| 1612334 | 50, 211 |
| 1612335 | 50, 211 |
| 1903486 | 60, 78 |
| 1903487 | 60, 78 |
| 1903720 | 60, 66 |
| 1939343 | 60, 73, 78 |
| 1939344 | 60 |
| 2029030 | 20, 29 |
| 2029047 | 20, 29 |
| 2029056 | 97 |
| 2029058 | 97 |
| 2029102 | 20, 29 |
| 2029104 | 20, 29 |

Tooling Part Number Index

| Part No. | Page | Part No. | Page | Part No. | Page | Part No. | Page |
|----------|--------------------------------------|----------|-------------------------|----------|---------------------------|----------|----------------------------|
| 58074 | 163, 206 | 91502 | 22, 209-210 | 455822 | 112, 206 | 567309 | 166, 212 |
| 58373 | 166, 210 | 91504 | 155, 210 | 455830 | 112, 155, 206 | 567337 | 145, 212 |
| 58374 | 166, 210 | 91506 | 172-173, 192,210 | 457306 | 116 | 567418 | 86, 100, 211 |
| 58380 | 172, 192, 210 | 91508 | 172-173, 192,210 | 465644 | 155, 206 | 567902 | 211 |
| 58382 | 192, 201, 206 | 91510 | 172-173, 192,210 | 466320 | 155-156, 172-173, 212-213 | 567913 | 213 |
| 58439 | 172, 192, 210 | 91512 | 155-156, 210 | 466351 | 112, 211 | 567914 | 213 |
| 58514 | 210 | 91515 | 155, 210 | 466352 | 112, 211 | 567959 | 126-127, 212 |
| 58631 | 203, 210 | 91522 | 86, 96, 100, 210 | 466426 | 155, 212 | 567960 | 126-127, 212 |
| 58632 | 203, 210 | 91526 | 112, 210 | 466462 | 203, 213 | 587309 | 212 |
| 65780 | 209-210 | 91528 | 155 | 466588 | 172, 213 | 680307 | 126-127, 212 |
| 69710 | 166, 172, 192, 210 | 91529 | 86, 96, 100, 210 | 466597 | 172-173, 213 | 680308 | 126-127, 212 |
| 82276 | 210 | 91534 | 112, 210 | 466616 | 172, 212 | 680350 | 126, 212 |
| 90247 | 166 | 91536 | 86 | 466656 | 145, 212 | 680582 | 86, 100, 211 |
| 90546 | 210 | 91552 | 210 | 466686 | 55, 211 | 680854 | 100, 211 |
| 90547 | 210 | 91567 | 61, 210 | 466878 | 145, 212 | 680893 | 22, 211 |
| 90548 | 210 | 91569 | 61, 210 | 466913 | 211 | 680894 | 22, 211 |
| 90574 | 210 | 91594 | 100, 210 | 466917 | 212-213 | 687763 | 155, 172-173, 181, 212-213 |
| 90575 | 210 | 188688 | 126 | 466920 | 212-213 | 687765 | 155, 212 |
| 90714 | 126,210 | 189727 | 86, 206 | 466922 | 212 | 687898 | 172-173, 213 |
| 90717 | 86, 100,210 | 231894 | 163, 206 | 466955 | 211 | 687926 | 55, 211 |
| 90758 | 210 | 231920 | 163, 206 | 466959 | 212 | 687996 | 203, 206 |
| 90759 | 210 | 234603 | 12, 210 | 466986 | 211 | 691458 | 181 |
| 90760 | 210 | 234604 | 12, 210 | 466989 | 213 | 794381 | 22 |
| 90869 | 55, 210 | 234605 | 12 | 466990 | 211 | 843996 | 207 |
| 90870 | 55, 210 | 234912 | 61 | 567066 | 86, 96, 100, 211 | 854040 | 22, 211 |
| 90871 | 145,210 | 234914 | 61 | 567067 | 86, 96, 211 | 1385194 | 22, 211 |
| 90872 | 145, 210 | 305183 | 155, 206 | 567211 | 192, 213 | 1385377 | 120, 212 |
| 91002 | 55, 86, 145, 172, 181, 192, 203, 206 | 318831 | 55, 206 | 567212 | 192, 213 | 1385448 | 120, 212 |
| 91085 | 163, 206 | 318837 | 145, 206 | 567213 | 192, 213 | 1385817 | 120 |
| 91112 | 163, 206 | 318845 | 166, 206 | 567214 | 192, 213 | 1586343 | 22 |
| 91387 | 120, 210 | 318851 | 172, 181, 192, 201, 206 | 567216 | 173, 213 | 1586344 | 172, 206 |
| 91388 | 120, 210 | 354500 | 207 | 567251 | 211 | 1586700 | 50, 210 |
| 91500 | 172-173, 181, 192, 210 | 356114 | 201 | 567252 | 192, 213 | 1596277 | |
| 91501 | 22, 209-210 | 356337 | 201 | 567273 | 145, 212 | | |
| | | 356500 | 208 | 567306 | 166, 212 | | |

Engineering Notes



Engineering Notes



Engineering Notes



Americas

Argentina – Buenos Aires
 Phone: +54-11-4733-2200
 Fax: +54-11-4733-2211

Brasil – São Paulo
 Phone: +55-11-3611-1311
 Fax: +55-11-3611-0397

Canada – Toronto
 Phone: +905-475-6222
 Fax: +905-474-5520

**Product Information Center:
 (Technical Support)**
 Phone: +905-470-4425
 Fax: +905-474-5525

Colombia – Bogota
 Phone: +57-1-231-9398
 Fax: +57-1-660-0206

Mexico – Mexico City
 Phone: +52-55-1106-0800
 +01-800-733-8926
 Fax: +52-55-1106-0901

United States – Harrisburg, PA
 Phone: +717-564-0100
 Fax: +717-986-7575

**Product Information Center:
 (Technical Support)**
 Phone: +800-522-6752
 Fax: +717-986-7575

**For Latin/South American
 Countries not shown**
 Phone: +54-11-4733-2015
 Fax: +54-11-4733-2083

Asia/Pacific

Australia – Sydney
 Phone: +61-2-9554-2600
 Fax: +61-2-9502-2556

**Product Information Center:
 (Technical Support)**
 Phone: +61-2-9840-8200
 Fax: +61-2-9634-6188

India – Bangalore
 Phone: +91-80-285-40800
 Fax: +91-80-285-40820

Indonesia – Jakarta
 Phone: +65-6482-0311
 Fax: +65-6482-1012

Japan – Toyko
 Phone: +81-44-844-8111
 Fax: +81-44-812-3207

**Product Information Center:
 (Technical Support)**
 Phone: +81-44-844-8013
 Fax: +81-44-812-3200

Korea – Seoul
 Phone: +82-2-3415-4500
 Fax: +82-2-3486-3810

Malaysia – Kuala Lumpur
 Phone: +60-3-78053055
 Fax: +60-3-78053066

New Zealand – Auckland
 Phone: +64-9-634-4580
 Fax: +64-9-634-4586

Philippines – Makati City
 Phone: +632-848-0171
 Fax: +632-867-8661

People's Republic of China
 Hong Kong
 Phone: +852-2735-1628
 Fax: +852-2735-0243

Shanghai
 Phone: +86-21-2407-1588
 Fax: +86-21-2407-1599

Taiwan – Taipei
 Phone: +886-2-8768-2788
 Fax: +886-2-8768-2268

Singapore – Singapore
 Phone: +65-6482-0311
 Fax: +65-6482-1012

Thailand – Bangkok
 Phone: +66-2-955-0500
 Fax: +66-2-955-0505

Vietnam and Indochina –
 Ho Chi Minh City
 Phone: +84-8 930-5546
 Fax: +84-8 930-3443

Europe/Middle East/Africa

Austria – Vienna
 Phone: +43-1 90 5 60-0
 Fax: +43-1 90 5 60-1333

Belgium – Kessel-Lo
 Phone: +32-16-35-23-00
 Fax: +32-16-35-23-52

Bulgaria – Sofia
 Phone: +359-2-971-2152
 Fax: +359-2-971-2153

Czech Republic – Kurim
 Phone: +420-5-41-162-111
 Fax: +420-5-41-162-223

Denmark – Glostrup
 Phone: +45-43-480-452
 Fax: +45-43-441-414

Egypt – Cairo
 Phone: +20-2-29 04 281
 Fax: +20-2-41 92 334

Estonia – Tartu
 Phone: +372-5138-274
 Fax: +372-7400-779

Finland – Helsinki
 Phone: +358-95-12-34-20
 Fax: +358-95-12-34-250

France – Cergy-Pontoise
 Phone: +33-1-3420-8888
 Fax: +33-1-3420-8600

**Product Information Center:
 (Technical Support)**
 Phone: +33-1-3420-8943
 Fax: +33-1-3420-8623

Germany – Bensheim
 Phone: +49-6251-133-0
 Fax: +49-6251-133-1600

**Product Information Center:
 (Technical Support)**
 Phone: +49-6251-133-1999
 Fax: +49-6251-133-1988

Germany – Langen
 Phone: +49-6103-709-0
 Fax: +49-6103-709-1223

Germany – Speyer
 Phone: +49-6232-30-0
 Fax: +49-6232-30-2243

Germany - HTS Division – Neunkirchen
 Phone: +49-2247-305-0
 Fax: +49-2247-305-122

Greece – Athens
 Phone: +30-210-9370-396/397
 Fax: +30-210-9370-655

Hungary – Budapest
 Phone: +36-1-289-1000
 Fax: +36-1-289-1010

Ireland – Dublin
 Phone: +353-1-820-3000
 Fax: +353-1-820-9790

Israel – Yokneam
 Phone: +972-4-959-0508
 Fax: +972-4-959-0506

Italy – Collegno (Torino)
 Phone: +39-011-4012-111
 Fax: +39-011-4031116

Lithuania – Vilnius
 Phone: +370-5-2131-402
 Fax: +370-5-2131-403

Netherlands – 's-Hertogenbosch
 Phone: +31-73-624-62-46
 Fax: +31-73-621-23-65

**Product Information Center:
 (Technical Support)**
 Phone: +31-73-6246-999
 Fax: +31-73-6246-998

Norway – Nesbru
 Phone: +47-66-77-8886
 Fax: +47-66-77-8855

Poland – Warsaw
 Phone: +48-22-45-76-700
 Fax: +48-22-45-76-720

Romania – Bucharest
 Phone: +40-21-311-3479/3596
 Fax: +40-21-312-0574

Russia – Moscow
 Phone: +7-495-926-5506/07/08/09
 Fax: +7-495-926-5505

Russia – St. Petersburg
 Phone: +7-812-718-8192
 Fax: +7-812-718-8193

Slovenia – Ljubljana
 Phone: +386-1561-3270
 Fax: +386-1561-3240

South Africa – Port Elizabeth
 Phone: +2741-503-4500
 Fax: +2741-581-0440

Spain – Barcelona
 Phone: +34-93-291-0330
 Fax: +34-93-201-7879

**Product Information Center:
 (Technical Support):**
 Phone: +34-93-291-0330
 Fax: +34-93-200-3779

Sweden – Upplands Väsby
 Phone: +46-8-50-72-50-00
 Fax: +46-8-50-72-50-01

Switzerland – Steinach
 Phone: +41-71-447-0447
 Fax: +41-71-447-0444

Turkey – Istanbul
 Phone: +90-212-281-8181/2/3
 Fax: +90-212-281-8184

Ukraine – Kiev
 Phone: +380-044-206-2265
 Fax: +380-044-206-2264

United Kingdom – Swindon
 Phone: +44-8706-080-208
 Fax: +44-1793-572-516

**Product Information Center:
 (Technical Support)**
 Freephone GB: 0800-267-666
 Phone: +44-8706-080-208
 Fax: +44-208-420-8081

**For Middle East/African Countries Not
 Shown**
 Phone: +33-1-3420-8866
 Fax: +33-1-3420-8300

Tyco Electronics Corporation
Harrisburg, PA

tycoelectronics.com

82181-7.5M-MS-FP-4-08-2-0G3B



Mouser Electronics

Authorized Distributor

Click to View Pricing, Inventory, Delivery & Lifecycle Information:

[TE Connectivity:](#)

[770070-1](#)