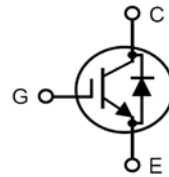
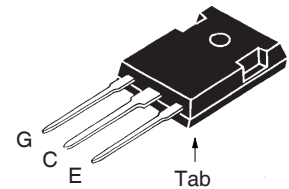

**900V XPT™ IGBT  
GenX3™ w/Diode**
**IXYH24N90C3D1**

 High-Speed IGBT  
for 20-50 kHz Switching

$$\begin{aligned} V_{CES} &= 900V \\ I_{C90} &= 24A \\ V_{CE(sat)} &\leq 3.0V \\ t_{fi(typ)} &= 90ns \end{aligned}$$

Symbol	Test Conditions	Maximum Ratings	
$V_{CES}$	$T_J = 25^\circ\text{C}$ to $150^\circ\text{C}$	900	V
$V_{CGR}$	$T_J = 25^\circ\text{C}$ to $150^\circ\text{C}$ , $R_{GE} = 1M\Omega$	900	V
$V_{GES}$	Continuous	$\pm 20$	V
$V_{GEM}$	Transient	$\pm 30$	V
$I_{C25}$	$T_C = 25^\circ\text{C}$	44	A
$I_{C90}$	$T_C = 90^\circ$	24	A
$I_{F110}$	$T_C = 110^\circ\text{C}$	15	A
$I_{CM}$	$T_C = 25^\circ\text{C}$ , 1ms	105	A
$I_A$	$T_C = 25^\circ\text{C}$	15	A
$E_{AS}$	$T_C = 25^\circ\text{C}$	150	mJ
<b>SSOA</b> <b>(RBSOA)</b>	$V_{GE} = 15V$ , $T_{VJ} = 125^\circ\text{C}$ , $R_G = 10\Omega$ Clamped Inductive Load	$I_{CM} = 48$ @ $V_{CE} \leq V_{CES}$	A
$P_C$	$T_C = 25^\circ\text{C}$	200	W
$T_J$		-55 ... +150	$^\circ\text{C}$
$T_{JM}$		150	$^\circ\text{C}$
$T_{stg}$		-55 ... +150	$^\circ\text{C}$
$T_L$	Maximum Lead Temperature for Soldering	300	$^\circ\text{C}$
$T_{SOLD}$	1.6 mm (0.062in.) from Case for 10s	260	$^\circ\text{C}$
$M_d$	Mounting Torque	1.13/10	Nm/lb.in.
<b>Weight</b>		6	g

**TO-247**

G = Gate      C = Collector  
E = Emitter    Tab = Collector

**Features**

- Optimized for Low Switching Losses
- Square RBSOA
- Positive Thermal Coefficient of  $V_{ce(sat)}$
- Anti-Parallel Ultra Fast Diode
- Avalanche Rated
- High Current Handling Capability
- International Standard Package

**Advantages**

- High Power Density
- Low Gate Drive Requirement

**Applications**

- High Frequency Power Inverters
- UPS
- Motor Drives
- SMPS
- PFC Circuits
- Battery Chargers
- Welding Machines
- Lamp Ballasts

Symbol	Test Conditions ( $T_J = 25^\circ\text{C}$ , Unless Otherwise Specified)	Characteristic Values		
		Min.	Typ.	Max.
$BV_{CES}$	$I_C = 250\mu\text{A}$ , $V_{GE} = 0V$	950		V
$V_{GE(th)}$	$I_C = 250\mu\text{A}$ , $V_{CE} = V_{GE}$	3.5		6.0 V
$I_{CES}$	$V_{CE} = V_{CES}$ , $V_{GE} = 0V$ $T_J = 125^\circ\text{C}$			75 $\mu\text{A}$ 400 $\mu\text{A}$
$I_{GES}$	$V_{CE} = 0V$ , $V_{GE} = \pm 20V$			$\pm 100$ nA
$V_{CE(sat)}$	$I_C = 24A$ , $V_{GE} = 15V$ , Note 1 $T_J = 125^\circ\text{C}$		2.30 2.95	3.00 V V

Symbol Test Conditions		Characteristic Values		
(T <sub>J</sub> = 25°C Unless Otherwise Specified)		Min.	Typ.	Max.
<b>g<sub>fs</sub></b>	I <sub>C</sub> = 24A, V <sub>CE</sub> = 10V, Note 1	8	14	S
<b>C<sub>ies</sub></b>	V <sub>CE</sub> = 25V, V <sub>GE</sub> = 0V, f = 1MHz		1190	pF
<b>C<sub>oes</sub></b>			64	pF
<b>C<sub>res</sub></b>			22	pF
<b>Q<sub>g(on)</sub></b>	I <sub>C</sub> = 24A, V <sub>GE</sub> = 15V, V <sub>CE</sub> = 0.5 • V <sub>CES</sub>		40	nC
<b>Q<sub>ge</sub></b>			10	nC
<b>Q<sub>gc</sub></b>			18	nC
<b>t<sub>d(on)</sub></b>	<b>Inductive load, T<sub>J</sub> = 25°C</b> I <sub>C</sub> = 24A, V <sub>GE</sub> = 15V V <sub>CE</sub> = 0.5 • V <sub>CES</sub> , R <sub>G</sub> = 10Ω Note 2		20	ns
<b>t<sub>ri</sub></b>			36	ns
<b>E<sub>on</sub></b>			1.35	mJ
<b>t<sub>d(off)</sub></b>			73	ns
<b>t<sub>fi</sub></b>			90	ns
<b>E<sub>off</sub></b>			0.40	0.70 mJ
<b>t<sub>d(on)</sub></b>	<b>Inductive load, T<sub>J</sub> = 125°C</b> I <sub>C</sub> = 24A, V <sub>GE</sub> = 15V V <sub>CE</sub> = 0.5 • V <sub>CES</sub> , R <sub>G</sub> = 10Ω Note 2		22	ns
<b>t<sub>ri</sub></b>			38	ns
<b>E<sub>on</sub></b>			2.60	mJ
<b>t<sub>d(off)</sub></b>			85	ns
<b>t<sub>fi</sub></b>			130	ns
<b>E<sub>off</sub></b>			0.55	mJ
<b>R<sub>thJC</sub></b>				0.62 °C/W
<b>R<sub>thCS</sub></b>		0.21		°C/W

### Reverse Diode (FRED)

Symbol Test Conditions		Characteristic Value		
(T <sub>J</sub> = 25°C, Unless Otherwise Specified)		Min.	Typ.	Max.
<b>V<sub>F</sub></b>	I <sub>F</sub> = 15A, V <sub>GE</sub> = 0V, Note 1			3.25 V
		T <sub>J</sub> = 150°C	2.0	V
<b>I<sub>RM</sub></b>	I <sub>F</sub> = 15A, V <sub>GE</sub> = 0V, -di <sub>F</sub> /dt = 250A/μs, V <sub>R</sub> = 600V		14	A
<b>t<sub>rr</sub></b>		T <sub>J</sub> = 100°C	340	ns
<b>R<sub>thJC</sub></b>				1.6 °C/W

### Notes:

1. Pulse test, t ≤ 300μs, duty cycle, d ≤ 2%.
2. Switching times & energy losses may increase for higher V<sub>CE</sub> (clamp), T<sub>J</sub> or R<sub>G</sub>.

### PRELIMINARY TECHNICAL INFORMATION

The product presented herein is under development. The Technical Specifications offered are derived from a subjective evaluation of the design, based upon prior knowledge and experience, and constitute a "considered reflection" of the anticipated result. IXYS reserves the right to change limits, test conditions, and dimensions without notice.

### IXYS Reserves the Right to Change Limits, Test Conditions, and Dimensions.

IXYS MOSFETs and IGBTs are covered by one or more of the following U.S. patents:	4,835,592	4,931,844	5,049,961	5,237,481	6,162,665	6,404,065 B1	6,683,344	6,727,585	7,005,734 B2	7,157,338B2
	4,860,072	5,017,508	5,063,307	5,381,025	6,259,123 B1	6,534,343	6,710,405 B2	6,759,692	7,063,975 B2	
	4,881,106	5,034,796	5,187,117	5,486,715	6,306,728 B1	6,583,505	6,710,463	6,771,478 B2	7,071,537	

### TO-247 (IXYH) Outline

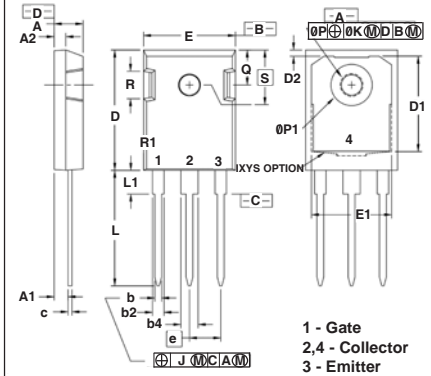

SYM	INCHES		MILLIMETERS	
	MIN	MAX	MIN	MAX
A	.190	.205	4.83	5.21
A1	.090	.100	2.29	2.54
A2	.075	.085	1.91	2.16
b	.045	.055	1.14	1.40
b2	.075	.087	1.91	2.20
b4	.115	.126	2.92	3.20
C	.024	.031	0.61	0.80
D	.819	.840	20.80	21.34
D1	.650	.690	16.51	17.53
D2	.035	.050	0.89	1.27
E	.620	.635	15.75	16.13
E1	.545	.565	13.84	14.35
e	.215 BSC		5.45 BSC	
J	--	.010	--	0.25
K	--	.025	--	0.64
L	.780	.810	19.81	20.57
L1	.150	.170	3.81	4.32
øP	.140	.144	3.55	3.65
øP1	.275	.290	6.99	7.37
Q	.220	.244	5.59	6.20
R	.170	.190	4.32	4.83
S	.242 BSC		6.15 BSC	

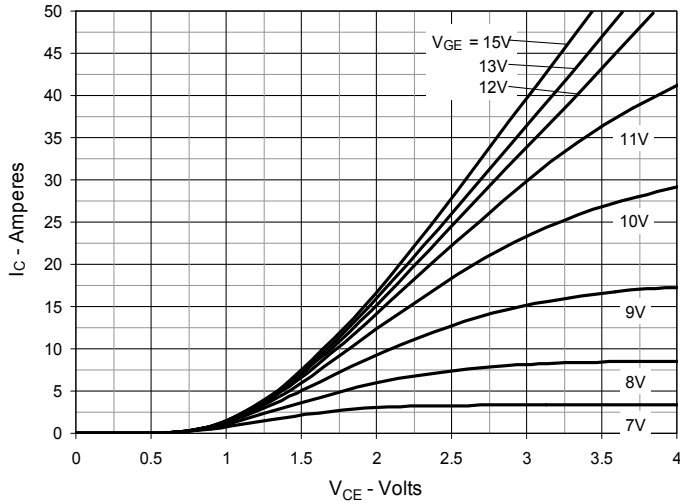
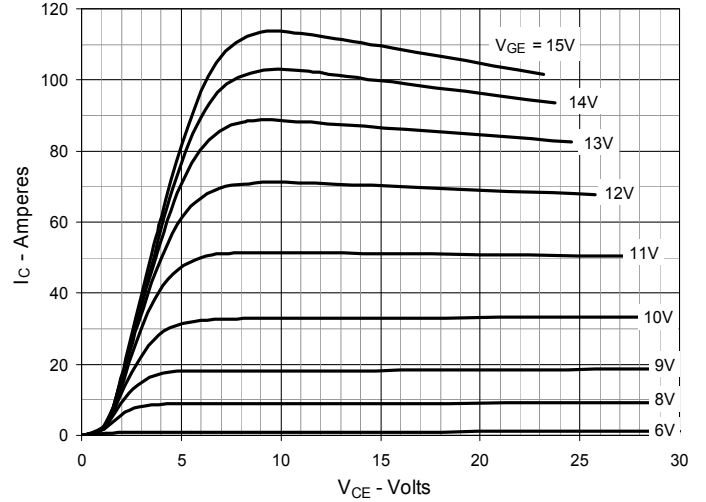
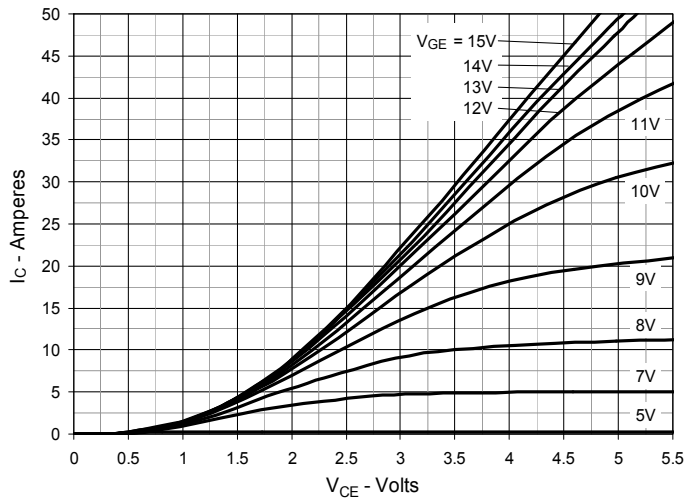
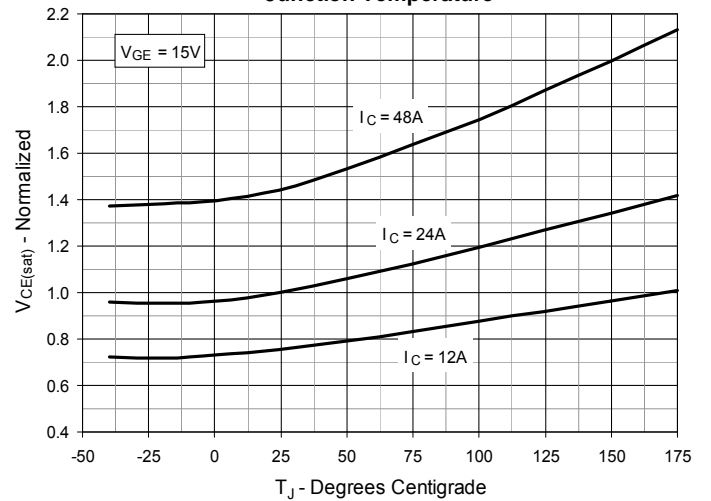
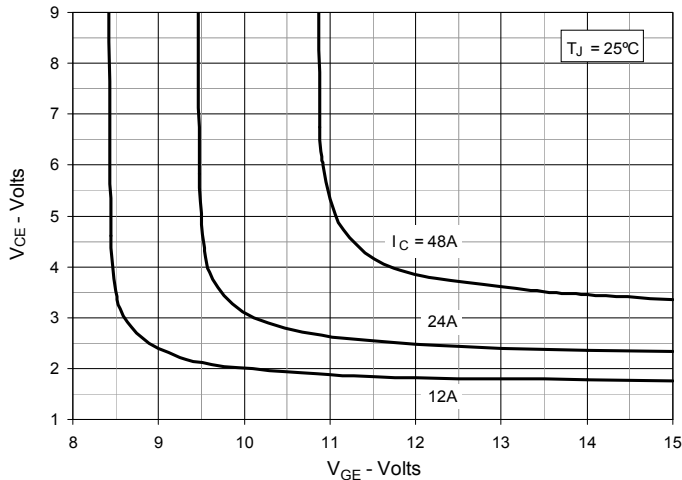
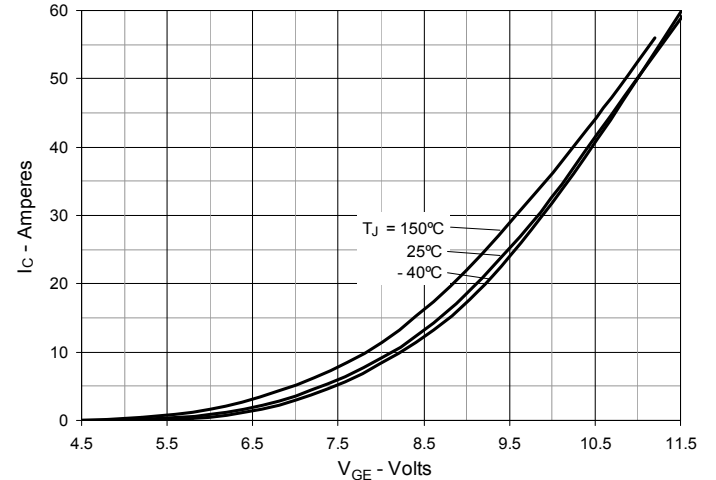
**Fig. 1. Output Characteristics @  $T_J = 25^\circ\text{C}$** 

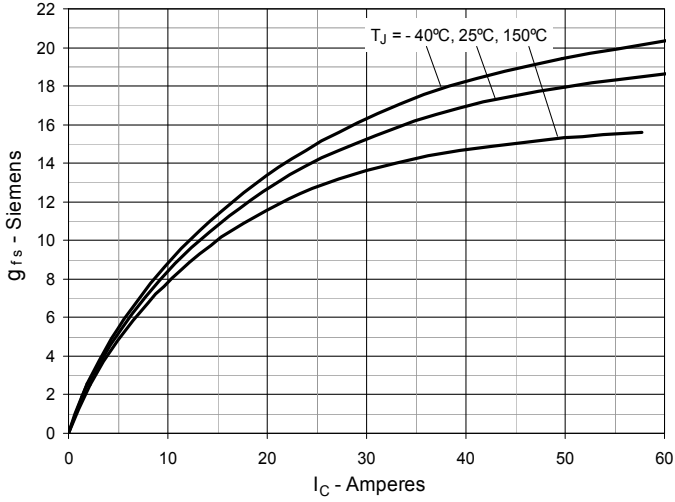
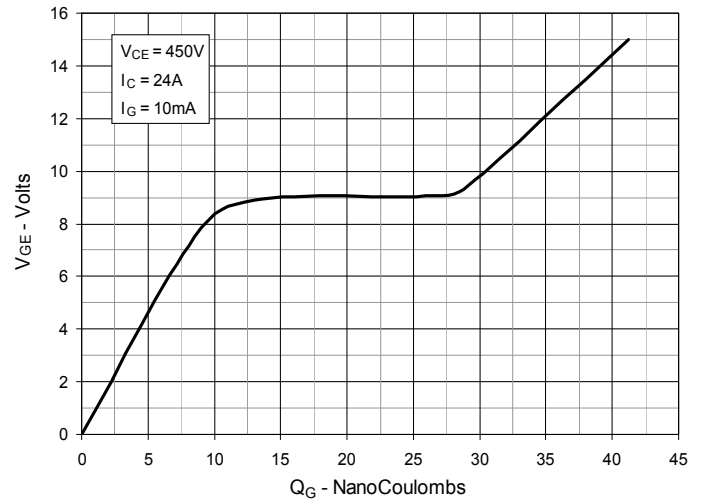
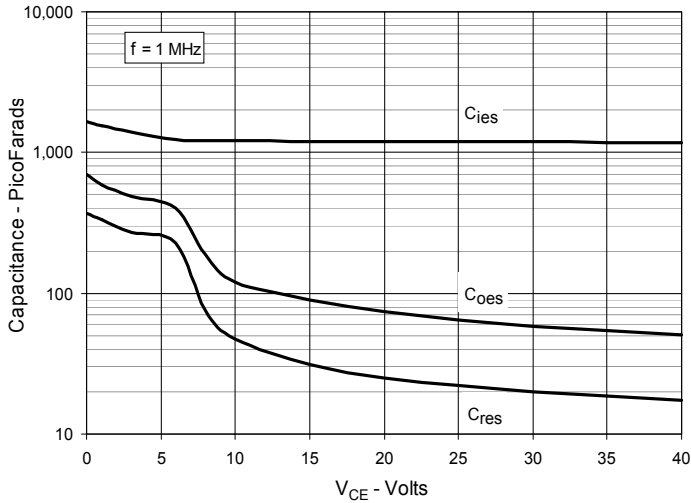
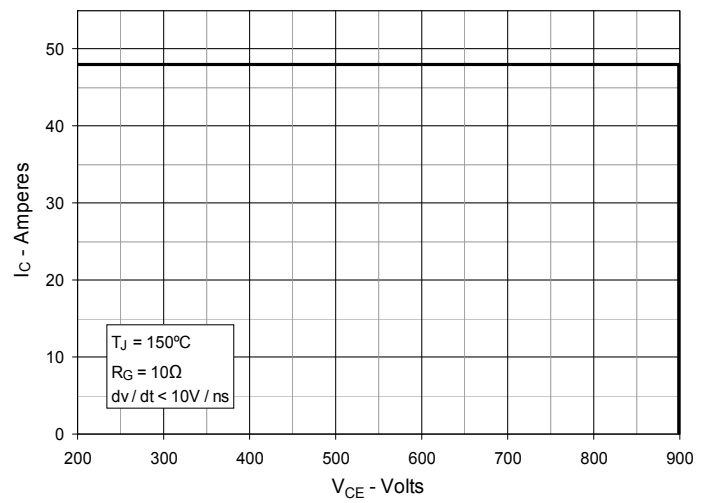
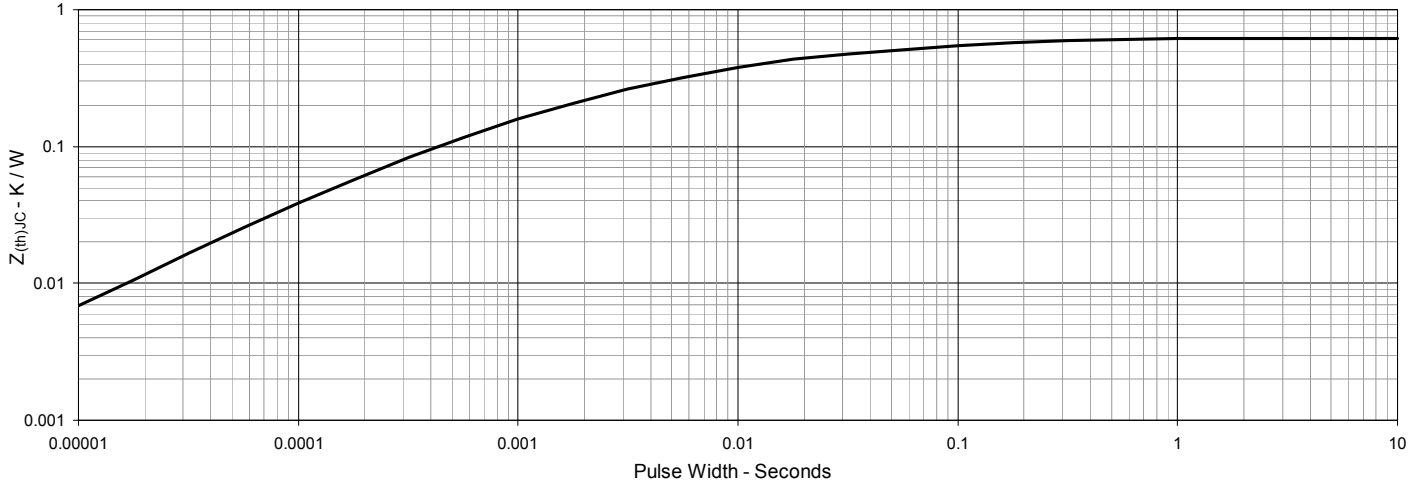
**Fig. 2. Extended Output Characteristics @  $T_J = 25^\circ\text{C}$** 

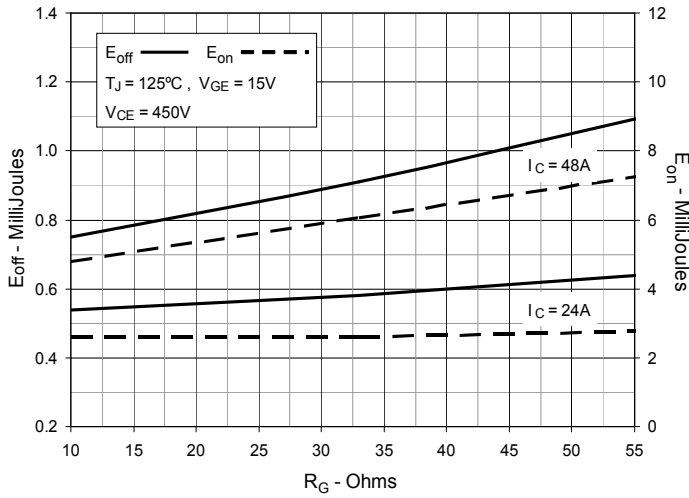
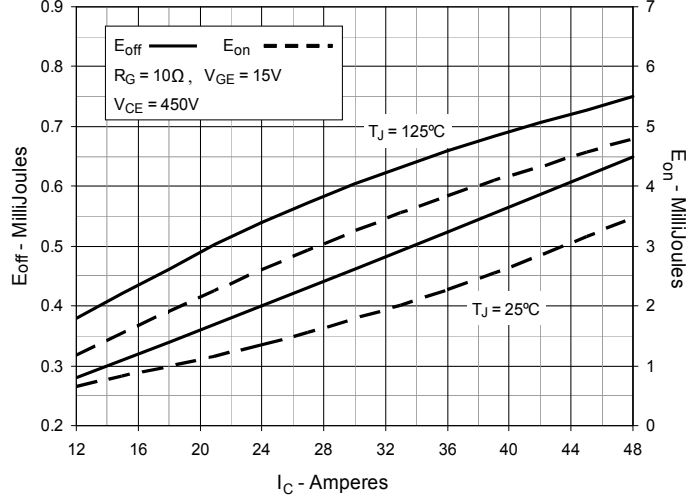
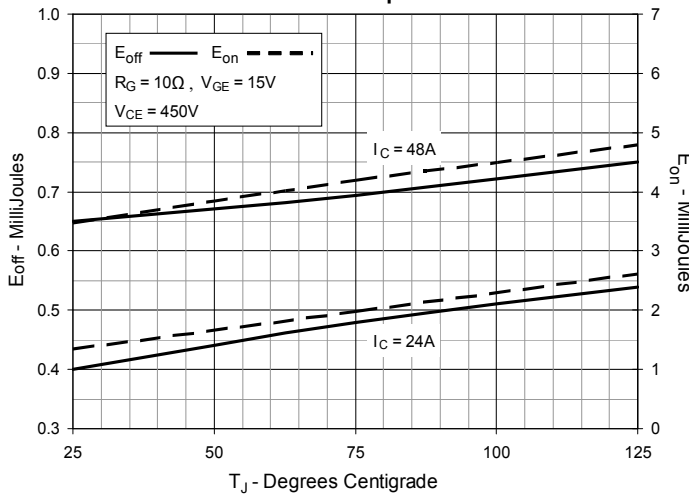
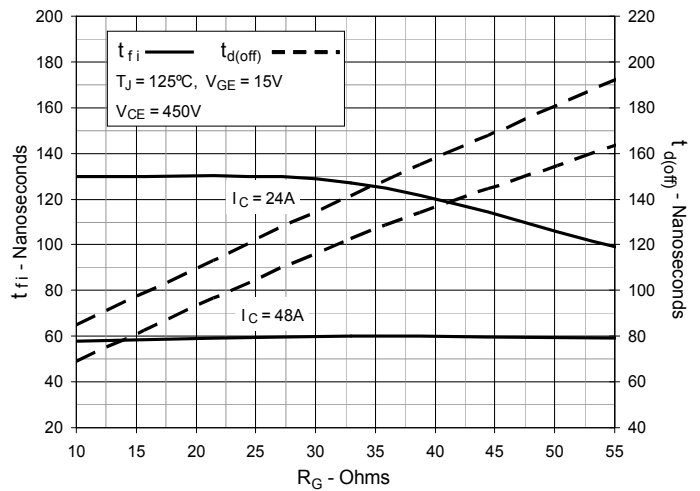
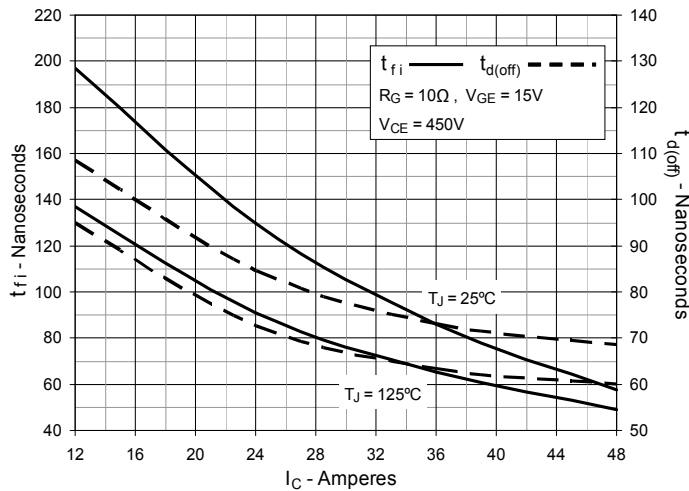
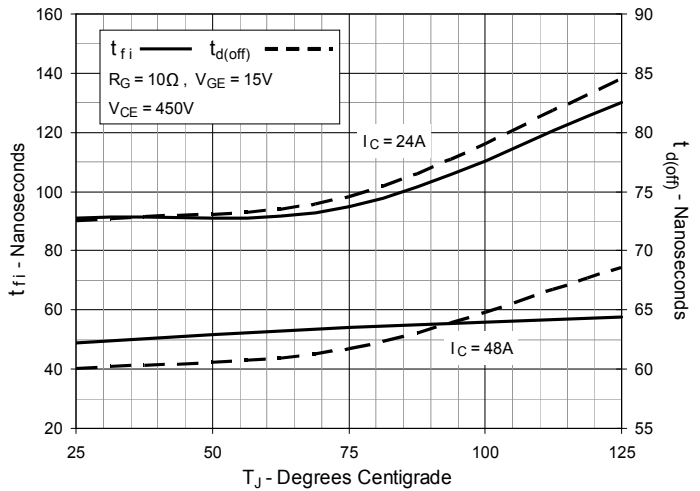
**Fig. 3. Output Characteristics @  $T_J = 150^\circ\text{C}$** 

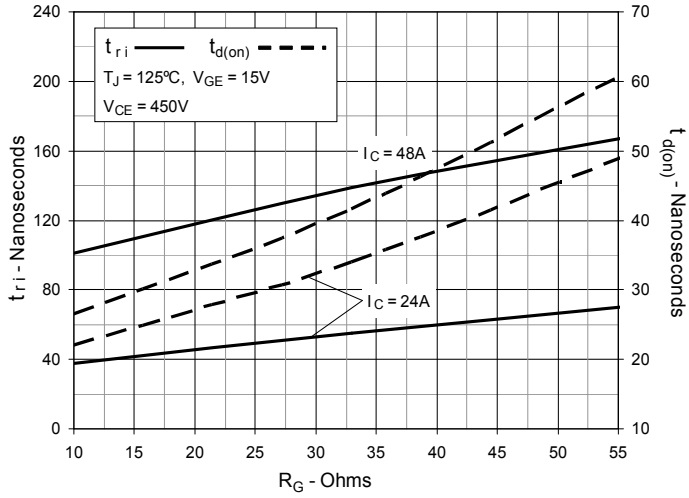
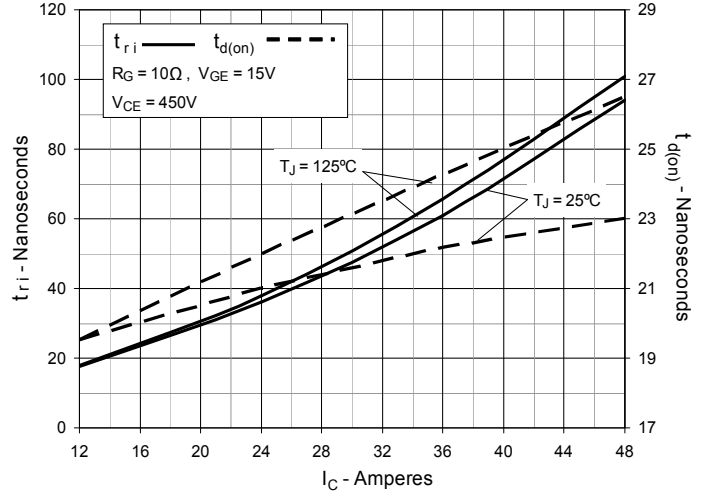
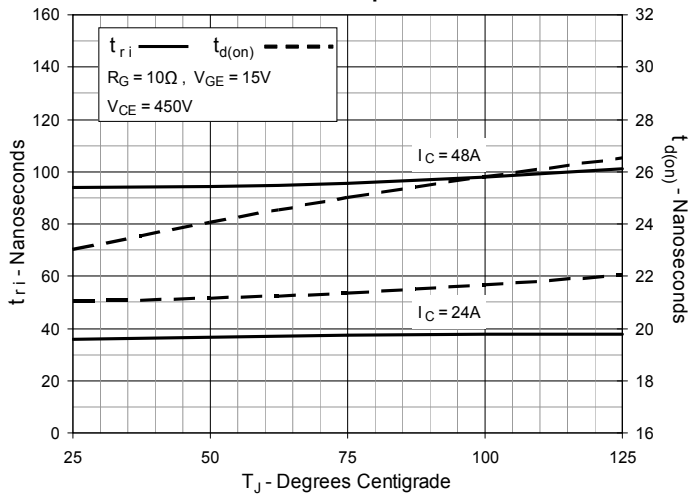
**Fig. 4. Dependence of  $V_{CE(sat)}$  on Junction Temperature**

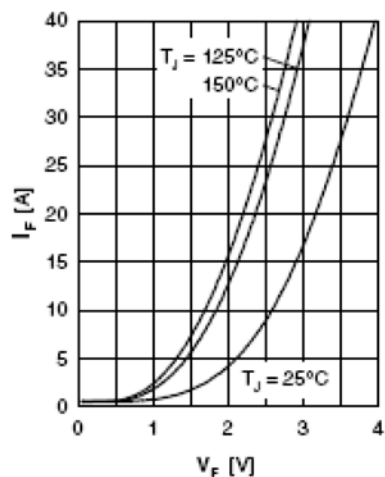
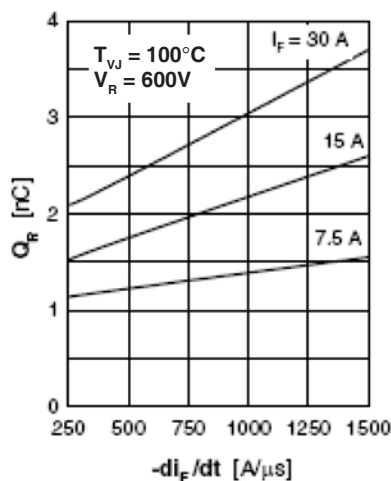
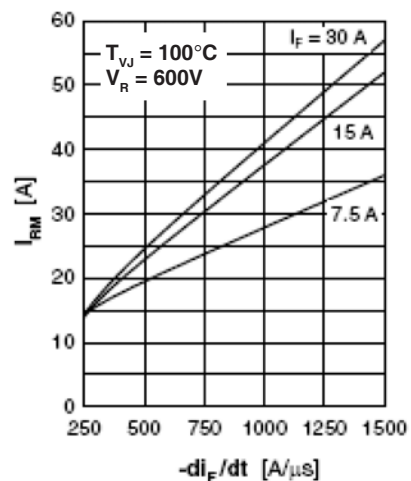
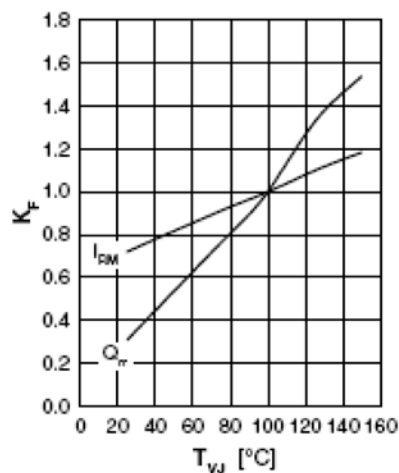
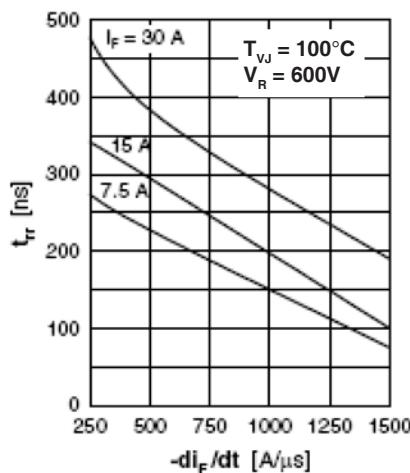
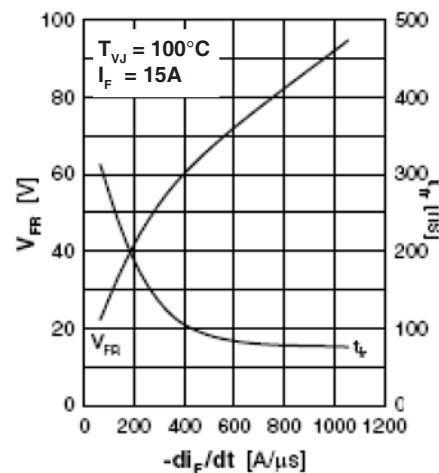
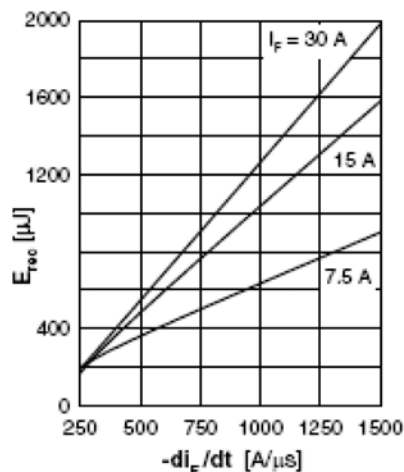
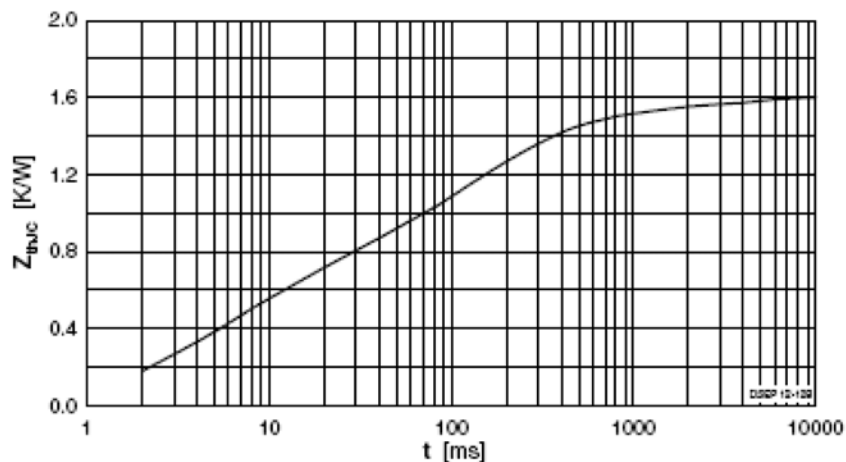
**Fig. 5. Collector-to-Emitter Voltage vs. Gate-to-Emitter Voltage**

**Fig. 6. Input Admittance**

**Fig. 7. Transconductance**

**Fig. 8. Gate Charge**

**Fig. 9. Capacitance**

**Fig. 10. Reverse-Bias Safe Operating Area**

**Fig. 11. Maximum Transient Thermal Impedance (IGBT)**

**Fig. 12. Inductive Switching Energy Loss vs. Gate Resistance**

**Fig. 13. Inductive Switching Energy Loss vs. Collector Current**

**Fig. 14. Inductive Switching Energy Loss vs. Junction Temperature**

**Fig. 15. Inductive Turn-off Switching Times vs. Gate Resistance**

**Fig. 16. Inductive Turn-off Switching Times vs. Collector Current**

**Fig. 17. Inductive Turn-off Switching Times vs. Junction Temperature**

**Fig. 18. Inductive Turn-on Switching Times vs. Gate Resistance**

**Fig. 19. Inductive Turn-on Switching Times vs. Collector Current**

**Fig. 20. Inductive Turn-on Switching Times vs. Junction Temperature**



**Fig. 21. Typ forward current  $I_F$  vs  $V_F$** 

**Fig. 22. Typ. reverse recovery charge  $Q_{RR}$  versus  $-di_F/dt$** 

**Fig. 23. Typ. peak reverse current  $I_{RM}$  versus  $-di_F/dt$** 

**Fig. 24. Dynamic parameters  $Q_{RR}$ ,  $I_{RM}$  versus  $T_{VJ}$** 

**Fig. 25. Typ. recovery time  $t_r$  versus  $-di_F/dt$** 

**Fig. 26. Typ. peak forward voltage  $V_{FR}$  and  $t_f$  versus  $-di_F/dt$** 

**Fig. 27. Typ. recovery energy  $E_{REC}$  versus  $-di_F/dt$** 

**Fig. 28. Maximum transient thermal resistance junction to case**

# Mouser Electronics

Authorized Distributor

Click to View Pricing, Inventory, Delivery & Lifecycle Information:

[IXYS:](#)

[IXYH24N90C3D1](#)