

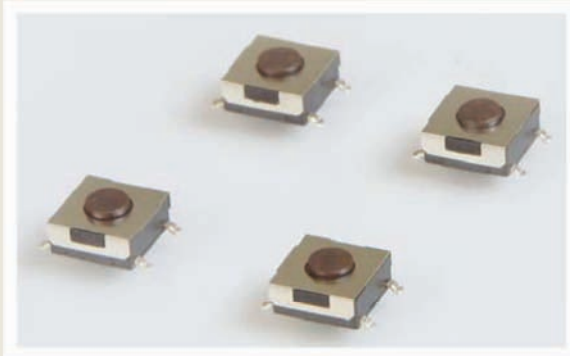

SERIES TL 3303 SWITCHES

TACT SWITCHES SMT - 6mm x 6mm



SPECIFICATIONS

Contact Rating:	50mA @ 12 VDC
Life Expectancy:	100,000 cycles typical
Contact Resistance:	100mΩ max. initial @ 2-4 VDC
Insulation Resistance:	100MΩ min.
Dielectric Strength:	250 VAC
Actuation Force:	100 ± 50 gf, 160 ± 50 gf, 260 ± 50 gf
Operating Temperature:	-20°C to 70°C
Travel:	0.25mm Typ

FEATURES & BENEFITS

- ▶ Earth ground terminal options
- ▶ Reliable dome contact technology
- ▶ Strong tactile/audible feedback

APPLICATIONS/MARKETS

- ▶ Telecommunications
- ▶ Consumer Electronics
- ▶ Audio/visual
- ▶ Medical
- ▶ Testing/instrumentation
- ▶ Computer/servers/peripherals



HOW TO ORDER

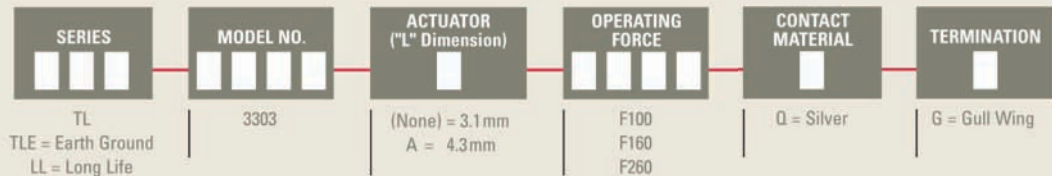

Example Ordering Number

TL-3303-F160-Q-G

Specifications subject to change without notice.

TL 3303/LL 3303

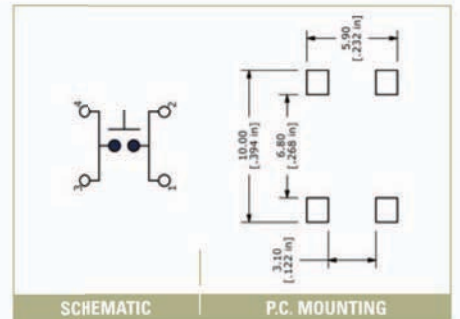
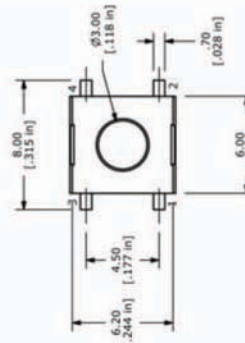
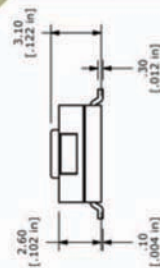

TLE 3303

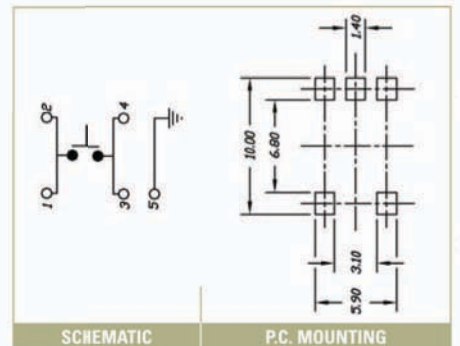
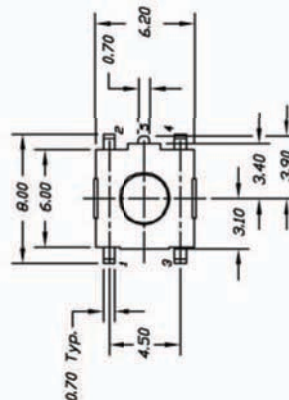
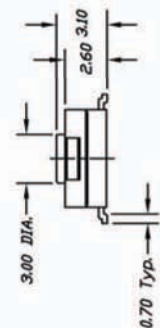

Mouser Electronics

Authorized Distributor

Click to View Pricing, Inventory, Delivery & Lifecycle Information:

E-Switch:

[TL3303F160QG](#) [TL3303AF100QG](#) [TL3303AF160QG](#) [TL3303AF260QG](#) [TL3303F100QG](#) [TL3303F260QG](#)
[LL3303F065QG](#) [TLE3303F100QG](#) [TLE3303F260QG](#) [TLE3303F160QG](#) [TLE3303AF160QG](#)