



PHOTOELECTRIC SENSOR

DIGITAL FIBER SENSOR

FX-300 SERIES



Conforming to
EMC Directive



UL Recognition

Constant advances achieving the highest level of performance in its class



The FX-300 series of next-generation fiber sensors provides the highest level of sensing performance in its class

'Stable sensing', 'high sensing performance', 'easy operation', 'improved ease of maintenance' and 'preservation of the environment' are the five concepts underlying the new FX-300 series!

June 2004
FX-301 advances
even further
(Refer to p.34 for details)



High-function

To high-speed

High-function type
FX-305

Standard type
FX-301

Ultra high-speed type
FX-301-HS

35 μs



Concept 1
High Stability

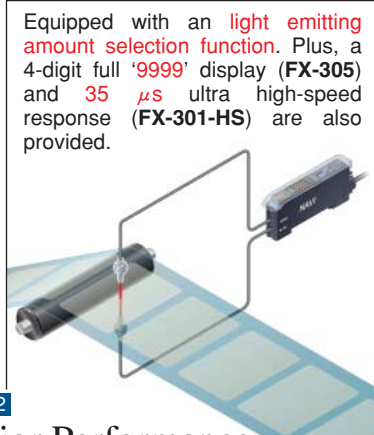

Concept 2
Superior Performance

FX-300 SERIES



Concept 5
Eco-friendly

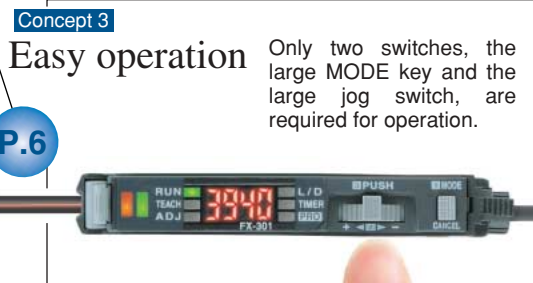
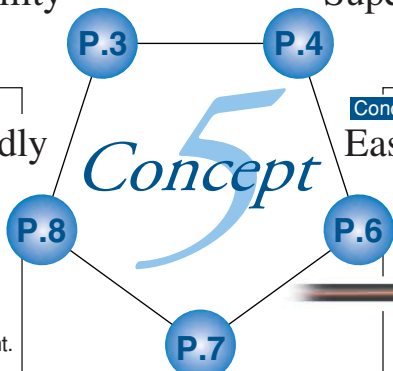

Concept 3
Easy operation

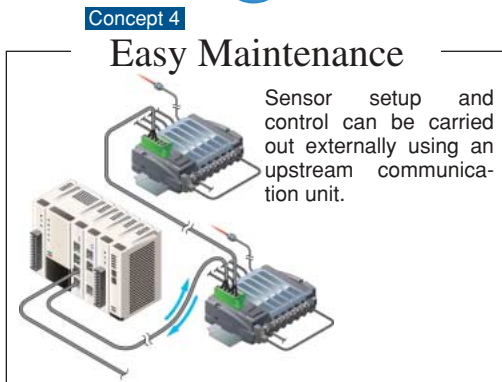

Concept 4
Easy Maintenance

Full range of fibers _____ Wide lineup

P.9 Guide for each industry Description of different fibers and performance for each industry

LCD • Semiconductor / P.9 to P.12



Electronic component • Automatic assembly / P.13 to P.14

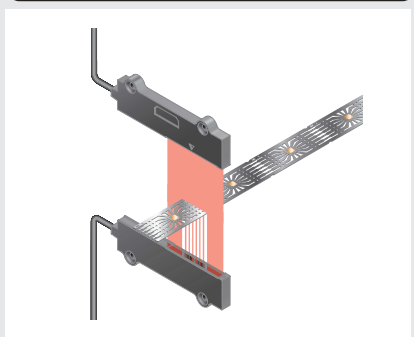

Pharmaceutical • Packaging / P.15



High Stability

Concept 1

High Stability

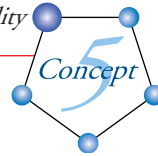

Stable sensing over long and short periods

Stability enhancement

FX-301 FX-301-HS FX-305

In addition to a 'four-chemical emitting element' which suppresses changes in the light emitting element over time so that a stable level of light emission can be maintained over long periods, a 'APC (Auto Power Control) circuit' has also been adopted afreshly. The light emitting amount can be controlled in minute degrees so that even changes occurring over very short periods can be handled, allowing stable sensing performance by suppressing deviations in light emitting amounts caused by changes in the ambient environment that could not previously be suppressed.

Stable sensing comparison

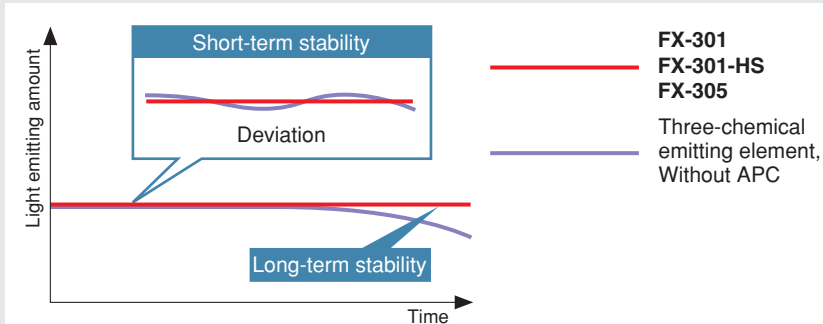

Even greater sensing range

FX-301/B/G/H FX-301-HS FX-305

Adoption of a 'double coupling lens' that increases emission efficiency to its maximum limits and greatly increases sensing range. Sensing ranges with small diameter fibers and ultra-small diameter fibers, which have become very popular due to the miniaturization of chip components, have been increased by 50 % over previous values achieved with other amplifiers.

Conventional fiber sensors (Without lens)



Disperses the light reduces emitting efficiency.

Double coupling lens

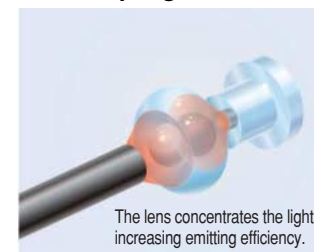

The lens concentrates the light, greatly increasing emitting efficiency.

Superior Performance

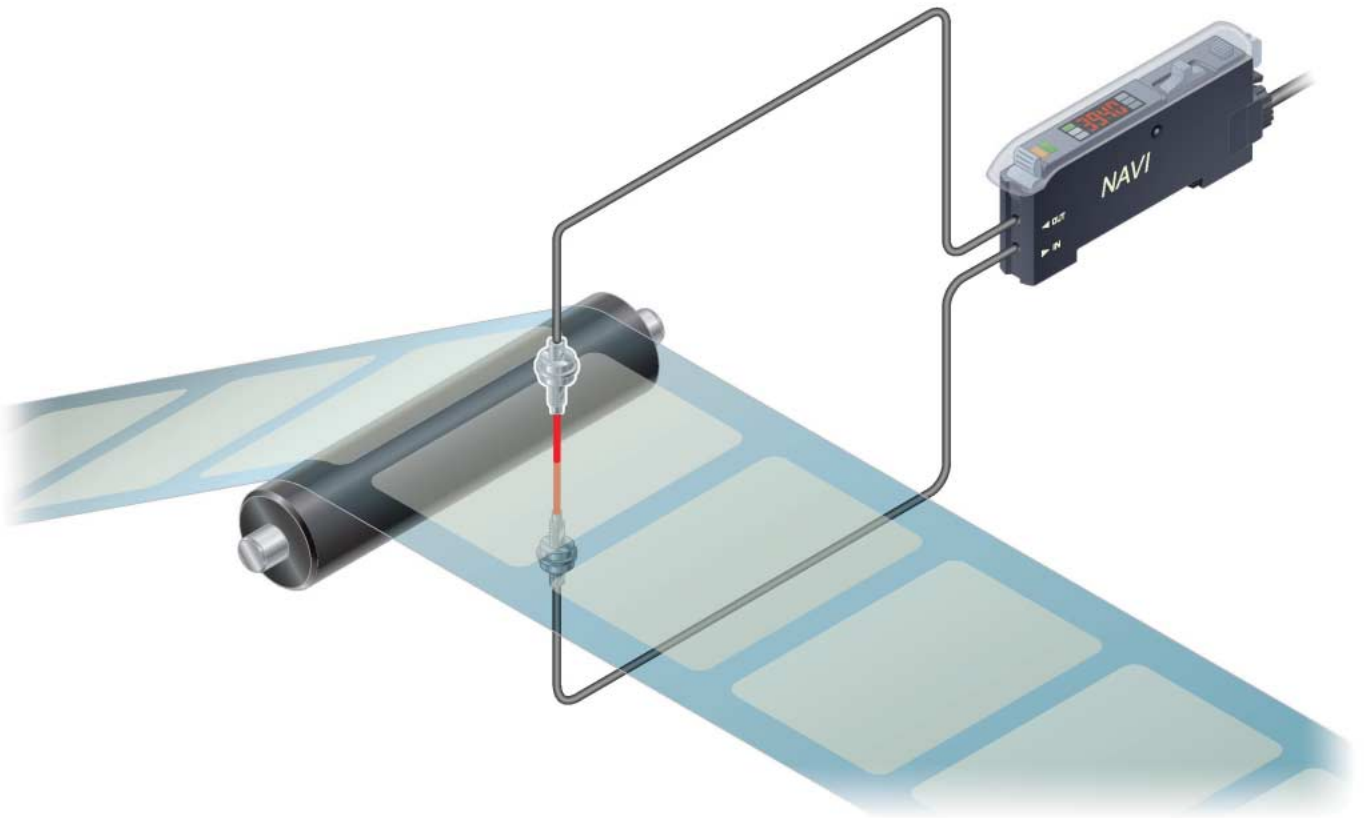
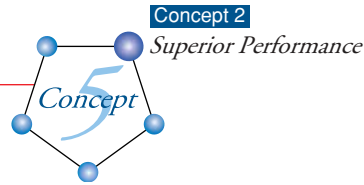

Light-emitting amount selection

If the light receiving level becomes saturated during close-range sensing or when sensing transparent or minute objects, you can adjust the light emitting amount of the sensor to stabilize sensing **without needing to change the response time**. Sensing that previously required the response time or fibers to be changed can now be set much more easily using this function.

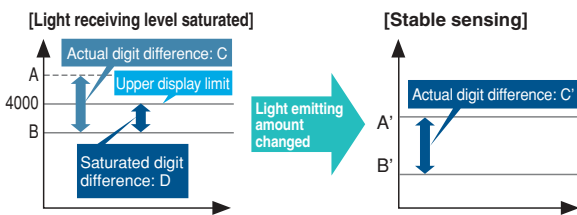

FX-301 FX-301-HS FX-305



Light emitting amount can be changed without changing response time

Large display 9999

2.5 times previous models

Large display with 4 digits (9999). With a greater difference in digit value than previous models, threshold values can be set in units of 1 digit up to maximum 9999. Threshold setting can now be done more easily and accurately.



(During STDF, LONG and U-LG modes)

Digit difference comparison

Example Digit difference between object A and object B

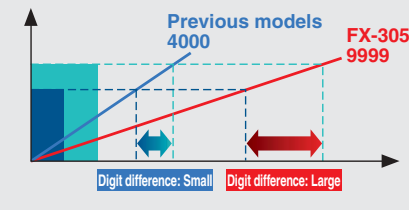

Ultra high-speed 35 μs response

4 times as fast as before

FX-301-HS

Ultra high-speed 35 μs response. Even small objects moving at high speeds can be sensed. In addition, at 65 μs the FX-301 standard type is also twice as fast as previous models.

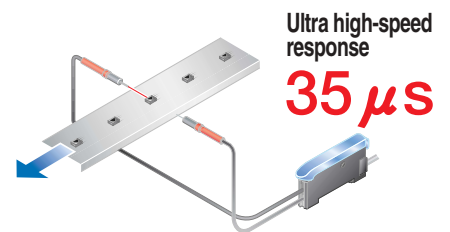

Ultra high-speed type FX-301-HS

(H-SP mode) 35 μs

Standard type FX-301, High-function type FX-305

(H-SP mode) 65 μs

Previous model

150 μs

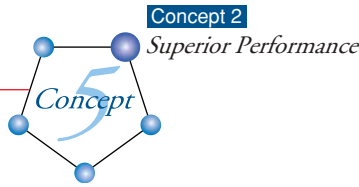

Simplified systems using new operating modes

FX-305

A window comparator mode and differential sensing mode have been added. These modes make it easy to carry out sensing tasks that previously required multiple sensors or involved complex threshold settings.

Window comparator mode



<Sensing ICs in trays>

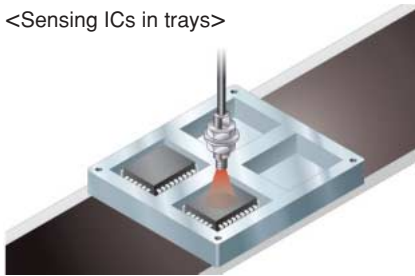

Tray absent	IC present	Tray present
OFF	ON	OFF

Incident light intensity

Upper and lower limits for threshold values can be set so that the incident light intensity can turn on and off within those ranges. Single output is used, so that only one cable is required, and no PLC processing is required either.

Differential sensing mode



<Sensing of tiny moving objects>

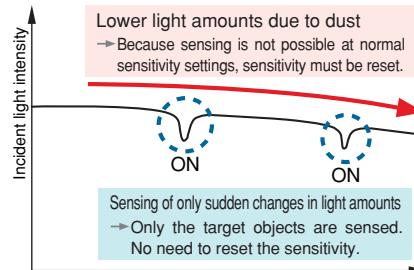
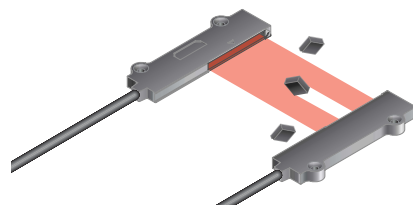

Equipped with 5 types timers

FX-305

The FX-305 includes the same ON-delay / OFF-delay / ONE-SHOT timer as the FX-301(-HS), as well as an ON-delay•OFF-delay timer and an ON-delay•ONE-SHOT timer. A wide variety of timer control operations can be carried out by these fiber sensors alone.

Timer period: Output 1 0.5 to 9,999 ms (variable)
Output 2 0.5 to 500 ms (variable)

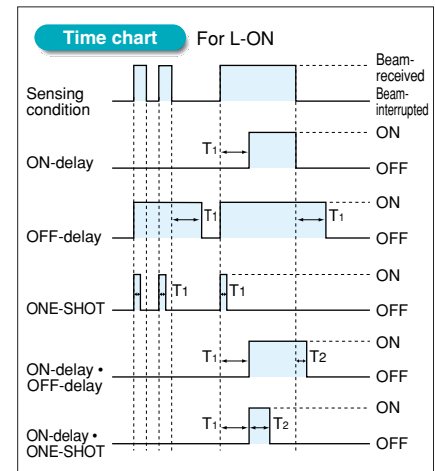

Multi-purpose 2-output

Two independent output channels are provided, so that one sensor can be used for control tasks that previously required two sensors. In addition, the second output channel can be used for simple self-diagnosis and alarm output, so that ease of maintenance is improved.



FX-305

New Alarm output: Output 2 is set concurrently with output 1

Drops in light amounts due to problems such as broken fibers or dirty tips are detected and output. When output 1 threshold value teaching is carried out with the FX-305, output 2 is set concurrently with the setting shifted by the amount of surplus.

Drops in surplus amounts of light intensity due to dust or other particles can therefore be detected and output.

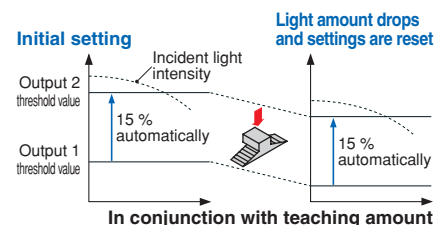

Comparison with previous models Example Sensing meandering of sheets

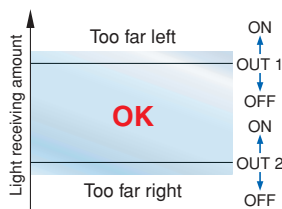

[Previous models]

2 sensors needed

[FX-305]

1 sensor is enough!

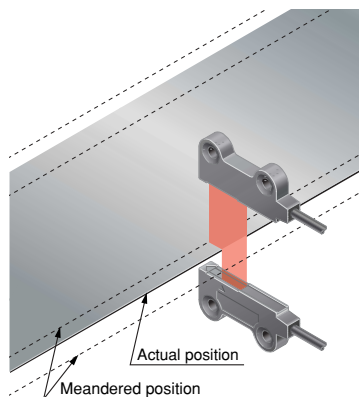

Easy operation

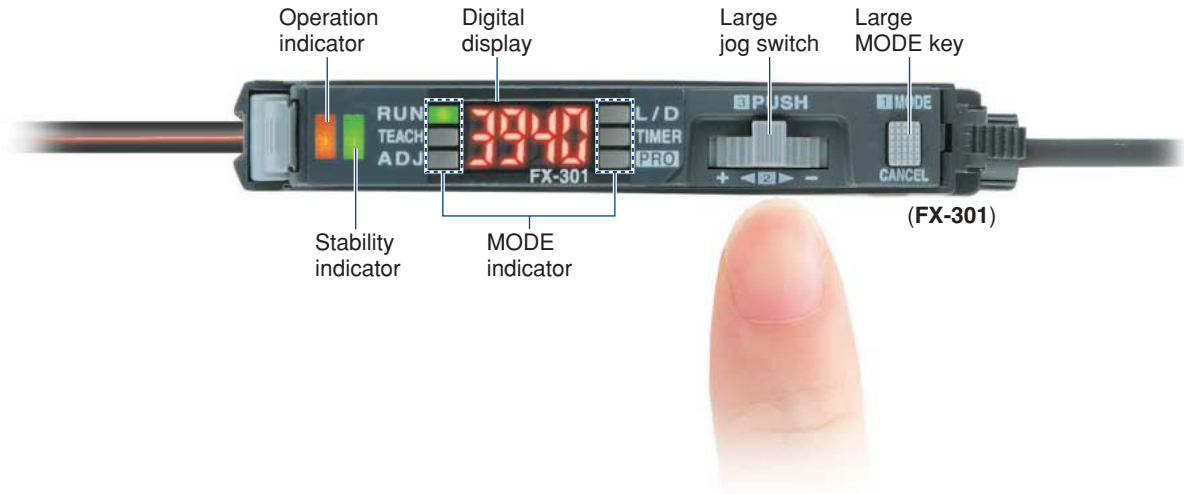
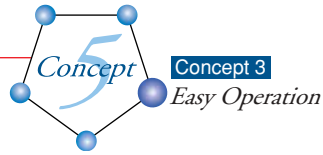

Even beginners can quickly learn how to use the MODE NAVI

MODE NAVI uses six indicators to display the amplifier's basic operations. The current operating mode can be confirmed at a glance, so even a first time user can easily operate the amplifier without becoming confused.

RUN	RUN → This is the sensing mode. Incident light level is displayed in the digital display.
TEACH	TEACH → This mode is for setting the threshold value.
ADJ	ADJ → In this mode, the threshold value, once set, may be fine-tuned.



L/D	L/D ON → This mode allows the selection of output operation as either Light-ON or Dark-ON.
TIMER	TIMER → This mode permits the choice of using or not using the timer.
PRO	PRO → This mode allows the selection of further advanced functions, such as the copying of individual settings and the memory functions.

The use of only two switches makes for very simple operations

Only two switches, the large jog switch and the large MODE key, are required for operation. Depressing the large MODE key sets the 'mode selection' and 'mode cancel' functions. The large jog switch is used to select from the detailed functions available within each mode, as well as to change numerical values after the mode has been chosen.

● Large MODE key

1 Pressing the switch selects or cancels the operating mode

● Large jog switch

2 Moving the switch from side to side allows items to be selected

3 Pressing the switch then confirms the selected setting

Easy confirming of threshold value settings

The threshold value can be confirmed by turning the jog switch even during RUN mode.

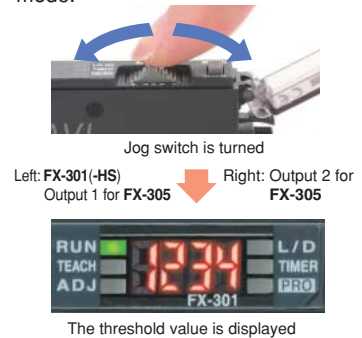

Improved workability! Data bank switching and teaching can be carried out externally

The FX-CH2 external input unit (optional) can be used to carry out teaching and data bank switching operations externally without needing to operate the digital fiber sensors directly. This greatly improves ease of workability during setup.



Key lock function prevents accidental setting changes

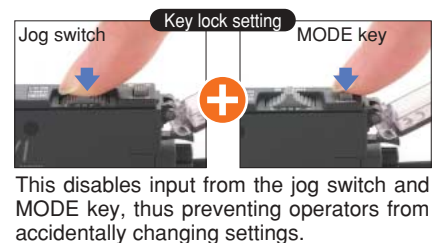

Easy Maintenance

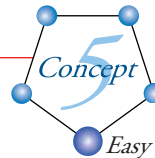

Concept 4
Easy Maintenance

Communication unit improves equipment starting up and maintenance upstream communication unit SC-GU1-485

FX-301 FX-305

The communication unit enables inputs to the digital fiber sensors (such as teaching and data bank switching) to be carried out via a PLC, and also allows confirming of the incident light intensity an output status for the fiber sensors. This greatly improves workability during equipment starting up and maintenance.

**We now offer remote maintenance for sensors!
Also reduces the work required to the system to start running!**

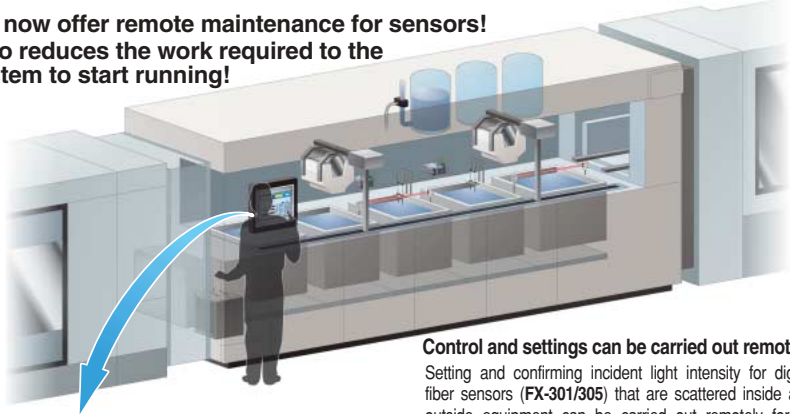

Control and settings can be carried out remotely
Setting and confirming incident light intensity for digital fiber sensors (FX-301/305) that are scattered inside and outside equipment can be carried out remotely for all sensors by using the SC-GU1-485, which greatly improves ease of operations such as monitoring equipment that is running and also equipment starting and maintenance.



<Touch screen monitor example>

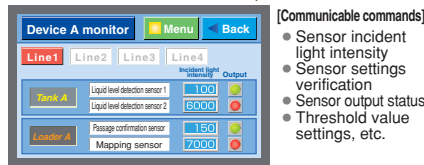

The sensor settings and operation can be checked on the touch screen, greatly improving ease of operation!

Ideal for workplaces such as semiconductor and LCD manufacturing lines where there are restrictions on operators entering and exiting

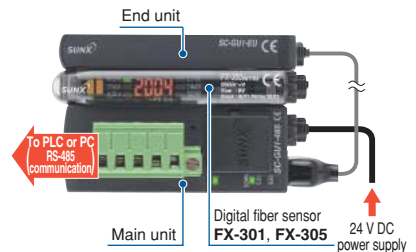

External input unit FX-CH2

FX-301 FX-305

Teaching and data bank switching for up to a maximum of 16 digital fiber sensors (FX-301 and FX-305) can be carried out all at once using an external device such as a PLC, touch screen or switch.

Support for stable sensing and smooth setup changes!

■ Setup changes (external automatic teaching / data bank switching)

Digital fiber sensor settings can be changed using input from a touch screen or switch, so that production line setup changes can be carried out more easily.

● External teaching

Full-auto teaching is recommended for teaching when the sensing object is changed without stopping the line.

● Data bank switching

Settings such as output operations (L-ON / D-ON) and timer operations can be recorded in the digital fiber sensor's data bank and switching can be carried out externally.

※ Up to 3 files can be stored.

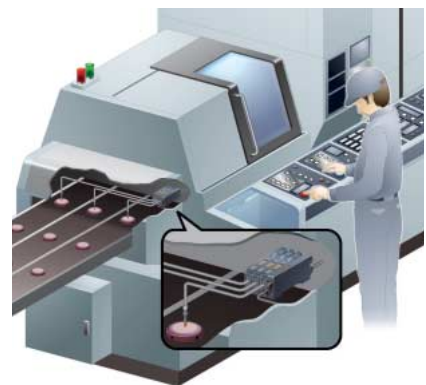

■ FX-CH2 function list

Teaching input

The following types of external teaching can be carried out.

- Full-auto teaching
- Limit teaching ' - '
- Limit teaching ' + '
- 2-level teaching

Data bank switching input

Switching between 3 channels of data banks and loading and saving of all channels at once can be carried out.

Key lock setting input

The key lock function that prevents incorrect operations by operators can be set on and off.

■ Product lineup

Connector for input device
CN-EP1 [1 pc. included with FX-CH2(-P)]

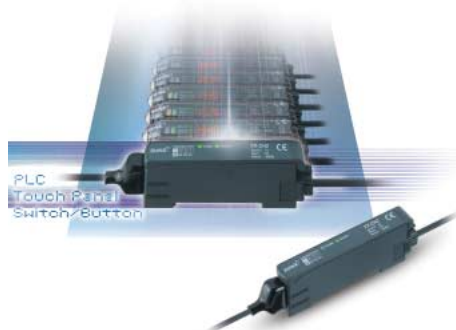
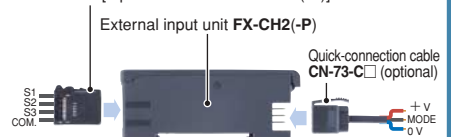

Wiring- and labor-saving design allows side-by-side configuration for up to sixteen units

FX-301/B/G/H FX-301-HS FX-305

One unit can be used as either a main unit or sub unit

The amplifier unit can be used as either a main unit or a sub unit. This feature allows for easy mounting in the side-by-side configuration. The main and sub unit functions are distinguished only by the proper use of the main cable and the sub cable. Moreover, inventory management and maintenance is simplified.

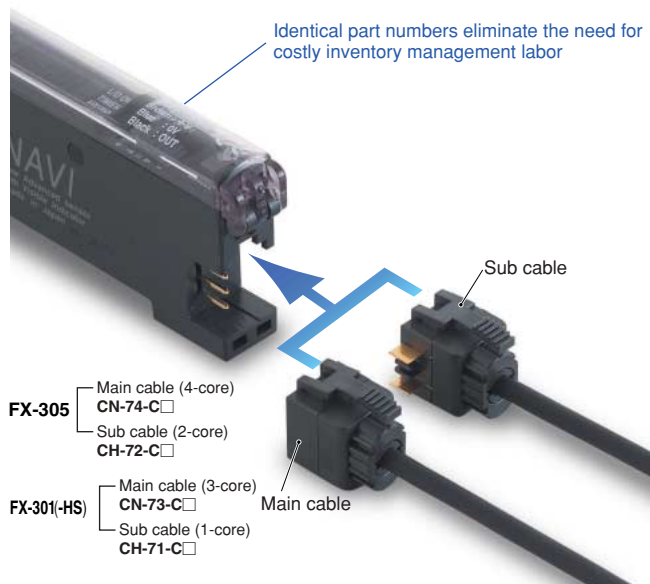

An optical communication function allows up to 16 sensors to be adjusted simultaneously

FX-301/B/G/H FX-305

The optical communication function allows the data that is currently set to be copied and saved all at once for all amplifiers connected together from the right side. This greatly reduces troublesome setup tasks and makes setup much smoother. In addition, troublesome adjustment operations at times such as when replacing sensors can also be carried out easily and data can also be copied and stored using the optical communication function.



※ Use the optical communication function for only the same types of sensors. Furthermore, the FX-301-HS is not equipped with optical communication function capability. Refer to p. 30 for details.

Settings can be entered directly using numerical input

Every function can be directly set merely by the input of a four digit code (numbers) from the code table. This convenient feature is easy to set up. In the event that settings are accidentally changed at the operating site, merely entering the correct code can restore the original settings. This results in easy and quick maintenance.

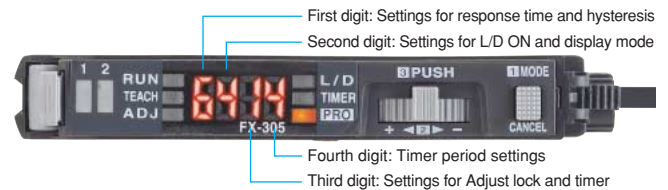

Eco-friendly

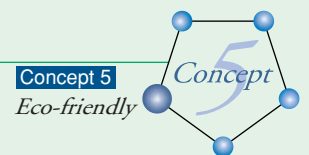

Lead-free solder used is gentle on the environment

SUNX promotes the use of lead-free materials in all of its sensor manufacturing processes including those used for the FX-300 series of digital fiber sensors.

Selectable cable length

Made available are 3 lengths, 1 m 3.281 ft, 2 m 6.562 ft, and 5 m 16.404 ft, to suit your application requirements. This helps reduce the waste caused by cutting cables and lightens the installation workload.

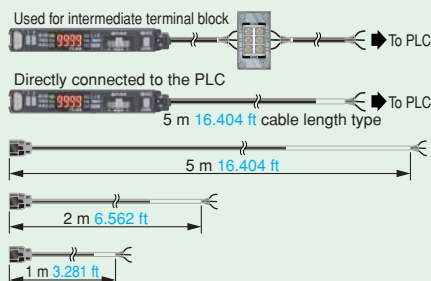

Reduced power consumption possible (ECO mode)

This turns off the digital display to reduce power consumption to approximately 600 W or less. (960 W is consumed when the display is on.)

Environmentally friendly packaging

With regard to effects on the environment, we only utilize the simplest of packaging methods greatly contributing to the reduction in wastes generated by your worksite. Also, the bags are made of polyethylene, a substance that doesn't give off polluting gases when burned.



Improved stability over long and short periods

FX-301 FX-301-HS FX-305

A **four-chemical emitting element** for stable sensing over long periods has been added, in addition to an **APC** (Auto Power Control) circuit that suppresses fluctuations in light amount over short periods. The light amount becomes stable a short period after the power is turned on, so setup time can be reduced.

• Stable sensing comparison

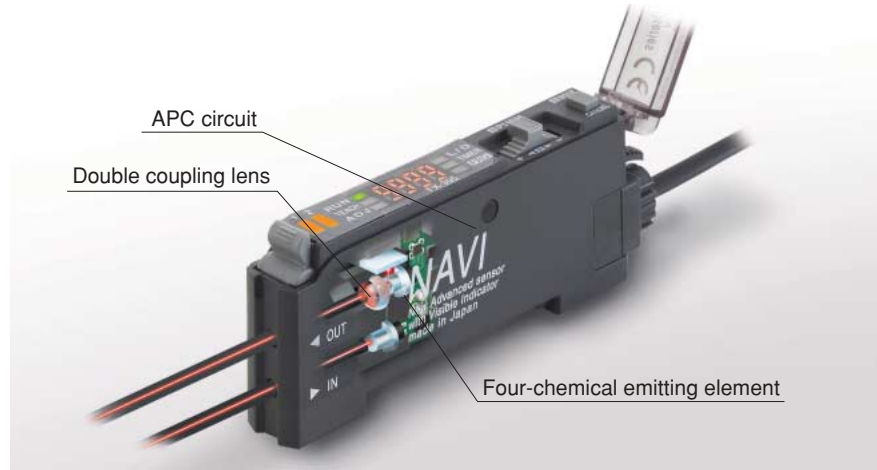
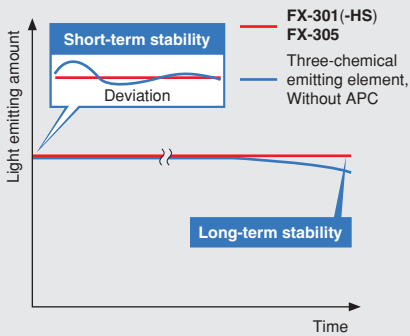

Mapping fiber

FT-KV1, FT-KV8, FR-KV1

This ultra-narrow optical beam fiber is ideal for mapping wafers.

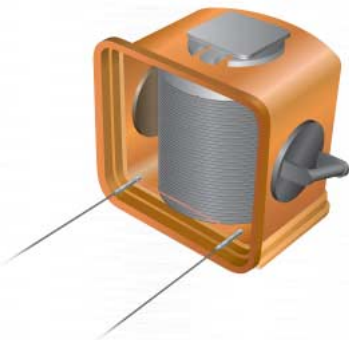

1.5 mm 0.059 in thickness FT-KV1
 W2 × H1.5 × D20 mm **W0.079 × H0.059 × D0.787 in** ultra-compact size allows this sensor to be installed even in thin 200 mm **7.874 in** wafer handlers.

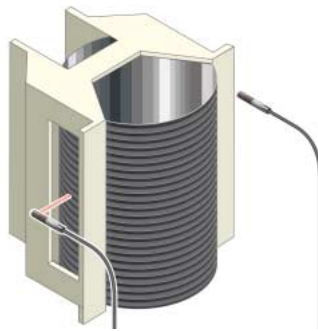

Aperture angle 2° FT-KV8, FT-KV8
 Aperture angle for the ultra-narrow optical beam is 2° or less. The light does not spread much at all, so that stable sensing can be obtained.

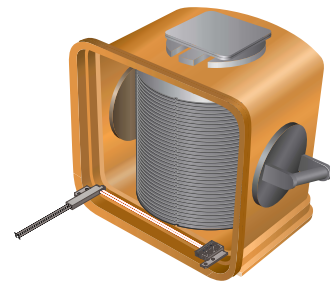

Retroreflective type FR-KV1
 With a thickness of 2.3 mm **0.091 in**, this fiber can be installed almost anywhere, and it is a retroreflective type so optical beam axis alignment is simple.

Heat-resistant fiber

FT-H□, FD-H□

A variety of types are available, including a convergent reflective type for accurately sensing glass substrates, and a type with a bending radius of 10 mm **0.394 in** that hardly takes up any space.

IC detection within a high temperature handler

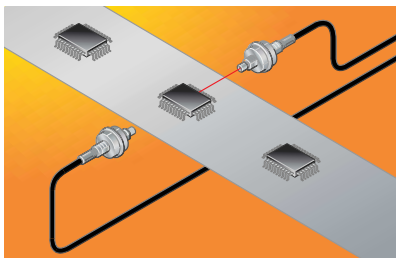

Flexible type FT-H20W-M2
 Withstands temperatures of +200 °C **+392 °F** and has a bending radius of 10 mm **0.394 in**, this fiber can be installed almost anywhere.

Glass substrate detection

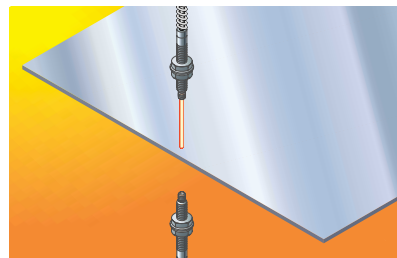

Heat-resistant 350 °C +662 °F FD-H35-M2
 Can be used in temperatures ranging from -60 to +350 °C **-76 to +662 °F**. Stable sensing is obtained even at temperatures exceeding +300 °C **+572 °F**.

Glass substrate detection

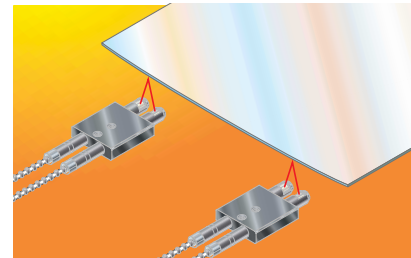

Convergent reflective type FD-H30-L32, FD-H18-L31
 Accurately senses glass substrates at high temperatures of +300 °C **+572 °F**.

Large display 9999

FX-305

Large display with 4 digits (9999).

Extremely fine settings for detecting minute changes can be made to provide more stable sensing for items such as transparent objects.

Contact type liquid level detection fiber FD-F8Y

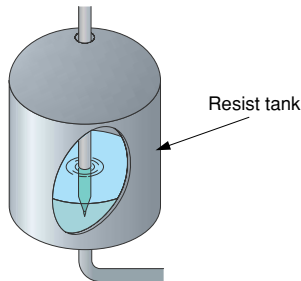

[Example of using liquid level detection fiber sensor (LONG mode)]

Previous display			FX-305	
	<digit value>	<Extra width>		<digit value> <Extra width>
Liquid absent	500	}	460	
Liquid present	40			
Liquid absent	2000	}	1840	
Liquid present	160			

Extra display width has been increased!

Around liquids • Chemical-resistant fiber FT-Z802Y, FD-F705, FT-F902

Chemical-resistant fiber with fluorine resin coatings over the whole of the fiber, leak detection fiber that quickly sense leaks such as from detergents, and liquid detection fiber that accurately sense liquid levels are among the lineup of fibers that are ideal for liquid sensing.

Detecting wafer cassette in cleaning tank

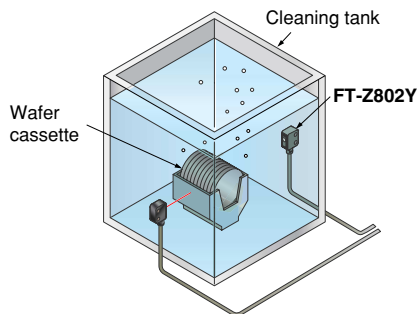

Chemical-resistant fiber FT-Z802Y

Fluorine resin coating allows fiber to be used with confidence even where contact with chemicals may occur.

Detecting leak liquid in cleaning tank (Note)

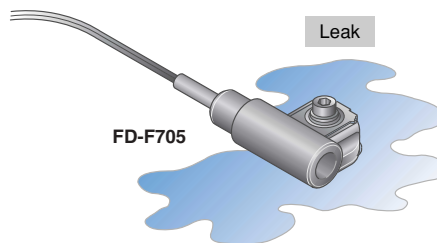

Leak detection fiber FD-F705

The unique effect of capillarity enables reliable detection of small leaks and viscous liquids.

Detecting liquid presence within a pipe (Note)

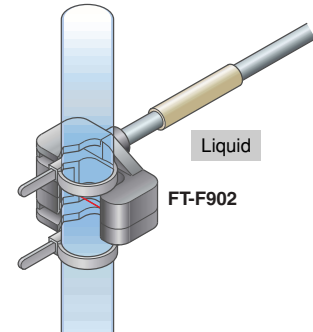

Liquid detection fiber FT-F902

Even if pipe diameters and thicknesses vary, the center of the beam axis always follows a straight line along the pipe, so that the setup environment has almost no effect on sensing.

Note: Use the FX-301-F amplifier that is specially designed for leak / liquid detection. For details, please refer to the 'sensor general catalog 2003-2004' or 'SUNX homepage' (<http://www.sunx.co.jp/>).

Vacuum-resistant fiber

FT/FD-□V

The vacuum-resistant fiber lineup lets you select the best fiber for the application. Withstanding temperatures of up to +300 °C +572 °F, a bending radius of 18 mm 0.709 in and bending durability of up to 100,000 times are features that greatly improve ease of use.

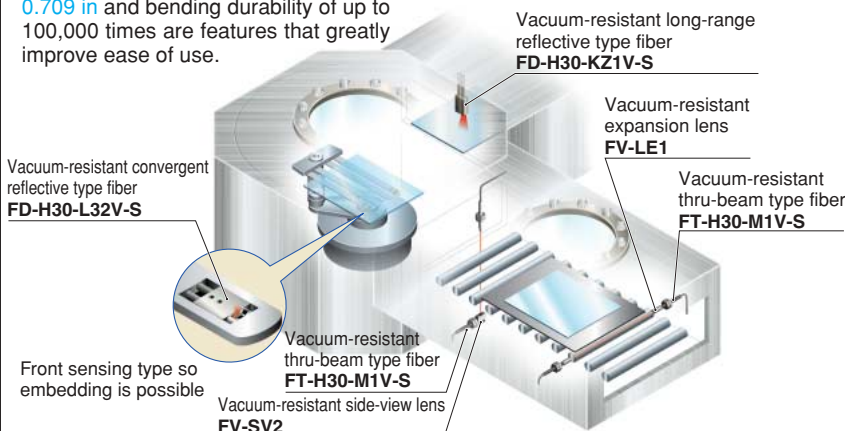

Vacuum-resistant convergent reflective type FD-H30-L32V-S

• Sensing range: 0 to 8 mm 0 to 0.315 in (LONG mode)

Vacuum-resistant long-range reflective type FD-H30-KZ1V-S

• Sensing range: 20 to 200 mm 0.787 to 7.874 in (LONG mode)

Vacuum-resistant thru-beam type FT-H30-M1V-S

• Sensing range: 250 mm 9.843 in (LONG mode)

Vacuum-resistant side-view lens FV-SV2

• Sensing range greatly increased without taking up space

Vacuum-resistant expansion lens FV-LE1

• Sensing range increased by 4 times or more

Light emitting amount selection function

FX-301 FX-301-HS FX-305

When sensing transparent objects and minute objects, the light emitting amount can be changed without changing the response time, even for cases where the incident light intensity is fully saturated, which was not possible with conventional models. This allows stable sensing to be maintained, and there is no longer any need to change the sensing range or change the fiber sensor as used to be required.

Example: Sensing glass substrate

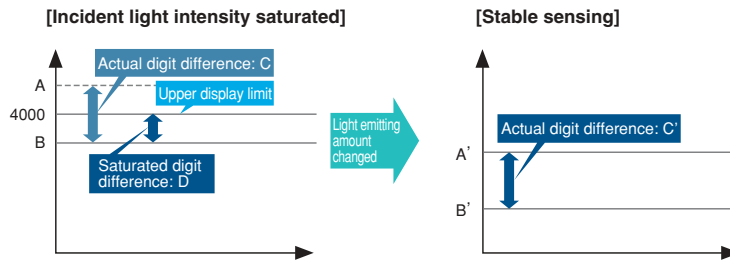
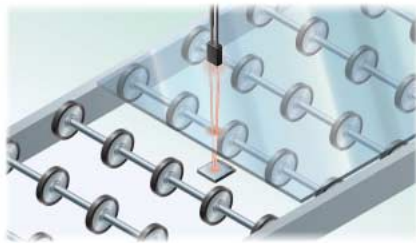

Comparison of saturation remedies

Previous models		FX-301(-HS), FX-305
<p>Remedy</p> <ul style="list-style-type: none"> • Changing response time • Changing fiber • Changing setting position 	<p>Problem</p> <ul style="list-style-type: none"> Mode selection → Affects positioning precision Change to thinner fiber to reduce light amount → Cost and man-hour inefficiencies Increase sensing range → Man-hour and space inefficiencies 	<p>Light emitting amount selection function makes steps such as those at left unnecessary.</p>

Fiber for glass substrate conveyor

FD-L40 series, FR-WKZ11

Fibers are available which are ideal for glass substrate conveyor processes.

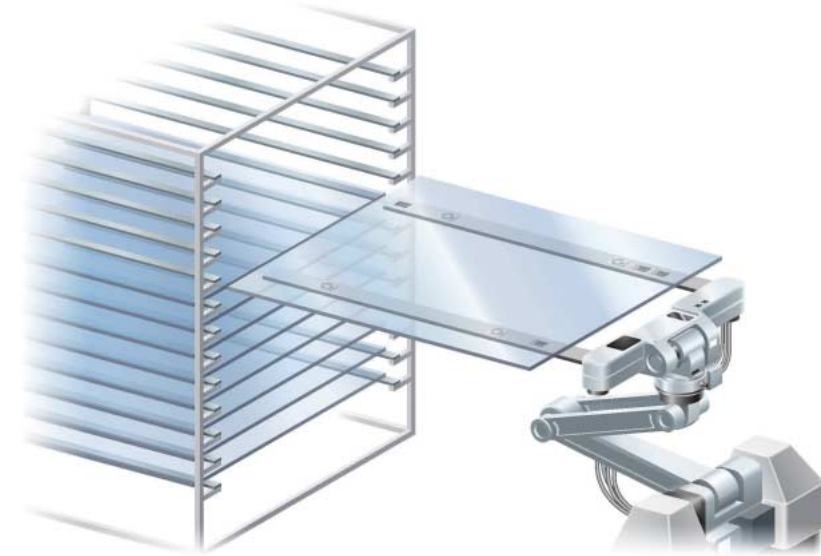

Alignment / Convergent reflective type FD-L43, FD-L45

Even glass substrates with $\pm 8^\circ$ (FD-L45: $\pm 6^\circ$) of flexure can be stably sensed.

- High flexure of $\pm 8^\circ$ (FD-L43)
- Long sensing range 30 mm 1.181 in (FD-L45)

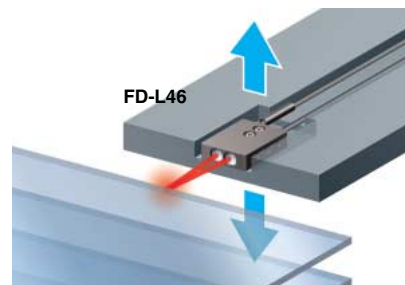

Mapping / Convergent reflective type FD-L46

Accurate mapping even for 0.5 mm 0.020 in thin glass substrates. A light weight of approximately 39 g means it can even be installed at the ends of handlers.



Seating confirmation / Convergent reflective type FD-L44

Long sensing range 0 to 6 mm 0 to 0.236 in for seating confirmation.

Sensing glass substrate through a view port

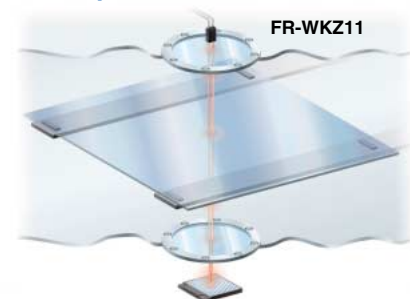

Retroreflective type FR-WKZ11

A polarization filter allows accurate sensing of glass substrates that pass by the view port.

- Long sensing range 1.5 m 4.921 ft (when sensing glass substrates)

External data bank switching and teaching are possible External input unit FX-CH2

FX-301 FX-305

The FX-CH2 external input unit (optional) can be used to carry out teaching and data bank switching operations externally without needing to operate the digital fiber sensors directly. This is ideal for locations such as clean rooms where entry and exit of personnel are restricted.

Sensing glass substrate (stable sensing of minute differences)

When sensing transparent objects and extremely small objects, variations in the incident light intensity caused by external factors such as slippage of the beam axis due to vibration can result in incorrect operation.

In such cases, periodically setting limit teaching '—' can be used to ensure more stable sensing.

The FX-CH2 can be used to carry out teaching externally, so that teaching can be carried out much more easily in places where entry and exit of personnel are restricted.

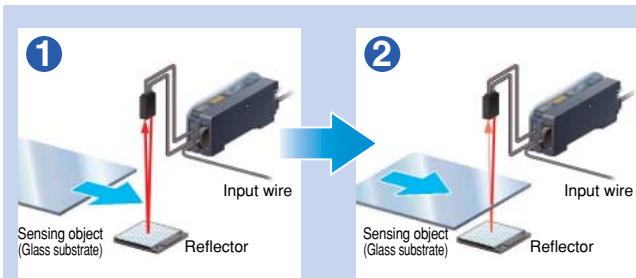
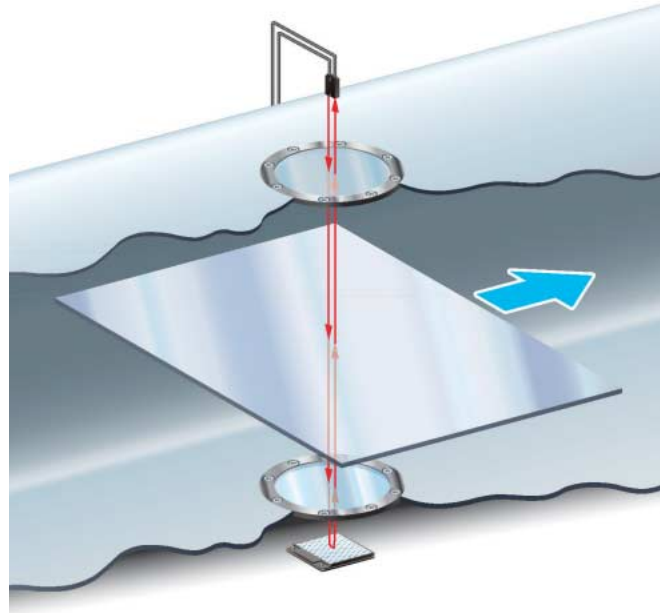

- ① Carry out limit teaching '—' before the sensing object (glass substrate) arrives (while there is no sensing object present). When the shift value is set to 5% beforehand, the threshold value is set to a value that is at a level 5% lower than the incident light intensity during teaching.
- ② Even when sensing glass substrates with high degrees of transparency (low damping), stable sensing is possible without changes in the light amount due to external causes.

Upstream communication for reading data and teaching are also possible Upstream communication unit SC-GU1-485

FX-301 FX-305

A PLC or computer can be used for sending inputs (teaching or data bank switching) to the digital fiber sensors, and also a communication unit can be used for confirming incident light intensities and output statuses for the digital fiber sensors, which is ideal for equipment such as semiconductor manufacturing equipment in places where entry and exit of personnel are restricted.

Example of use in semiconductor cleaning process

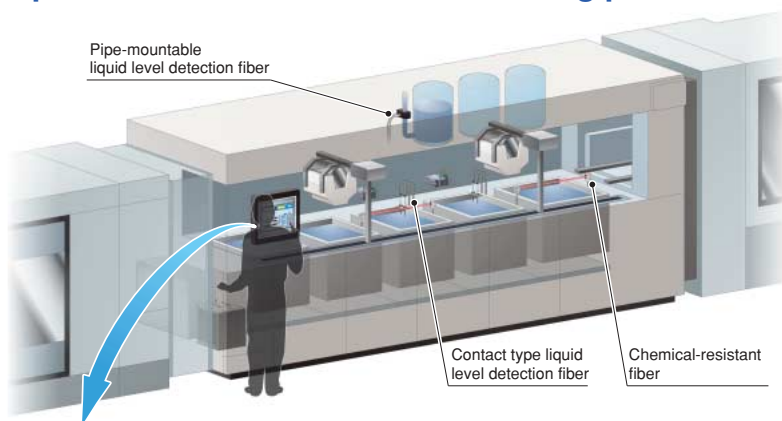

High general compatibility so that any type of PLC can be used

RS-485 communication provides a high level of general compatibility so that any type of PLC can be used. Integration with existing systems is possible without the need to change PLCs.

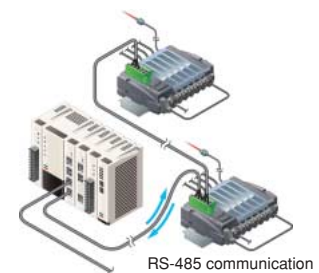

Compatible with all PLCs equipped with RS-485 compatible units

Communication speed 57.6 kbps

High-speed communication at a maximum speed of 57.6 kbps allows the operator to instantly confirm information such as the incident light intensity and output statuses of the digital sensors.

Series connection of a maximum of 31 nodes is possible

A maximum of 31 nodes can be connected in series. This is ideal for flexible handling when the sensors are to be installed in scattered locations or if more sensors are added.

Less wiring and installation work

Up to a maximum of 16 sensors can be connected side-by-side. Power can be supplied to all of them at once, so that less wiring and installation work is required. Wire-saving connectors also makes it possible to send output signals to the PLC in a single batch.

<Touch screen monitor example>

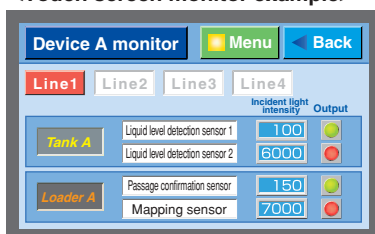

The sensor settings and operation can be confirmed on the touch screen, greatly improving ease of operation!

Ideal for workplaces such as semiconductor and LCD manufacturing lines where there are restrictions on operators entering and exiting

<Communicable commands>

- Sensor incident light intensity
- Sensor settings verification
- Sensor output status
- Threshold value settings, etc.

High-speed response 35 μ s

FX-301-HS

These digital fiber sensors have the fast response time of 35 μ s. They are ideal for sensing minute objects that are moving at high speeds.



Independent dual outputs

FX-305

Two independent output channels are provided, so that one sensor can be used for control tasks that previously required two sensors. In addition, the second output channel can be used for alarm output and error output, so that ease of maintenance is improved.

Screw length discrimination
[Distinguishing between sensing objects A, B and C]

Output 1 and output 2 can be used together to distinguish between sensing objects A, B and C.

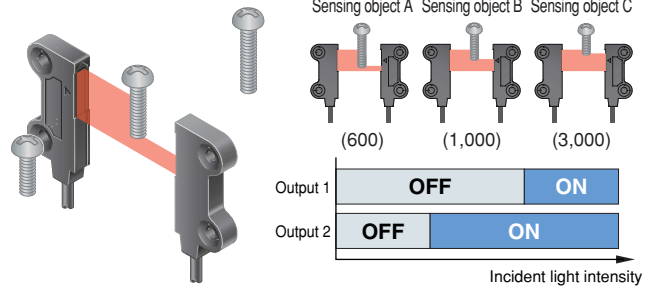

※ A window comparator mode for distinguishing between sensing objects with single output is also available.

Interference prevention up to maximum of sixteen units

FX-305

Interference prevention can be set for up to a maximum of 16 units, so that they can be used with confidence in locations where the fibers are installed in contact with each other. In addition, interference prevention for two fibers can be set during 65 μ s ultra high-speed mode.

Mode	Interference prevention switching function			
	IP-1		IP-2	
	No. of units	Response time	No. of units	Response time
H-SP	2 units	65 μ s	4 units	130 μ s
FAST	4 units	150 μ s	8 units	300 μ s
STD	4 units	250 μ s	8 units	500 μ s
STDF	4 units	700 μ s	8 units	1.4 ms
LONG	4 units	2.5 ms	8 units	5 ms
U-LG	8 units	4.5 ms	16 units	9 ms

For the FX-301/B/G/H, up to 4 units can be set.
The FX-301-HS is not equipped with an interference prevention function.

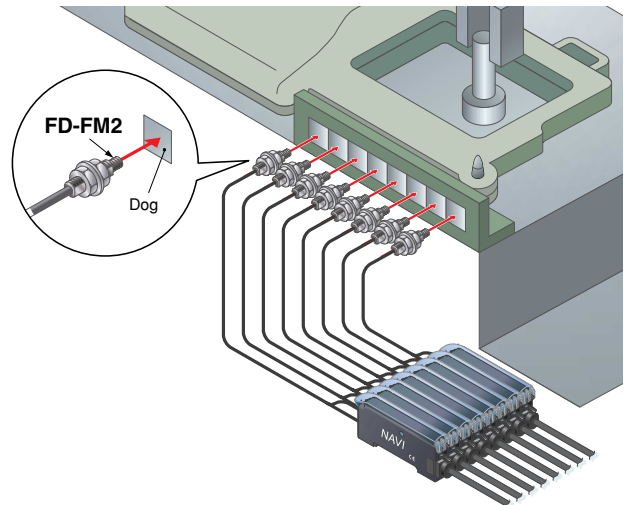

Improved ease of working! External data bank switching and teaching

FX-301 FX-305

The FX-CH2 external input unit (optional) can be used to carry out teaching and data bank switching operations externally without needing to operate the digital fiber sensors directly. This is very convenient for equipment which requires frequent setup changes.

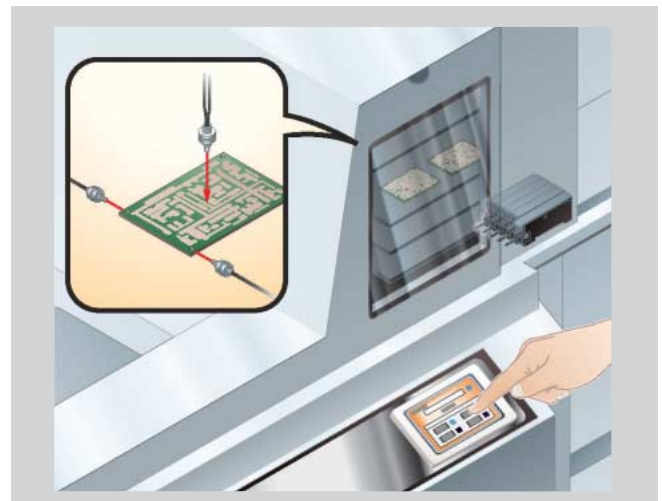

Wide beam fiber

FT-WA30/A30, FT-WA8/A8

It has a wide sensing width of 11 mm 0.433 in for the FT-WA8/A8 and 32 mm 1.260 in for the FT-WA30/A30 enabling long distance sensing of objects as far as 3,500 mm 137.795 in (with the FX-301 in long range mode). Optimal for detecting unsteady works or small objects.

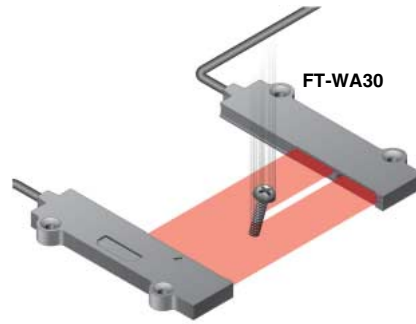

Detecting dropping screws

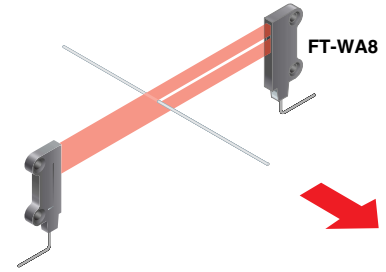

Wire breakage detection

Finest spot fiber

FX-MR6 + FD-EG3

An ultra-small $\phi 0.1$ mm $\phi 0.004$ in spot size has now been made possible by combining our precision fiber with our finest spot lens. The orientation of 0603 chips can also be discriminated stably.

Finest spot lens FX-MR6

Fiber model No.	Distance to focal point	Spot diameter
FD-EG3	7 ± 0.5 mm 0.276 ± 0.020 in	$\phi 0.1$ mm $\phi 0.004$ in approx.
FD-EG2	7 ± 0.5 mm 0.276 ± 0.020 in	$\phi 0.15$ mm $\phi 0.006$ in approx.
FD-EG1	7 ± 0.5 mm 0.276 ± 0.020 in	$\phi 0.2$ mm $\phi 0.008$ in approx.
FD-WG4/G4/G6X/G6	7 ± 0.5 mm 0.276 ± 0.020 in	$\phi 0.4$ mm $\phi 0.016$ in approx.

Finest spot lens FX-MR3

Fiber model No.	Distance to focal point	Spot diameter
FD-EG3	7.5 ± 0.5 mm 0.295 ± 0.020 in	$\phi 0.15$ mm $\phi 0.006$ in approx.
FD-EG2	7.5 ± 0.5 mm 0.295 ± 0.020 in	$\phi 0.2$ mm $\phi 0.008$ in approx.
FD-EG1	7.5 ± 0.5 mm 0.295 ± 0.020 in	$\phi 0.3$ mm $\phi 0.012$ in approx.
FD-WG4/G4/G6X/G6	7.5 ± 0.5 mm 0.295 ± 0.020 in	$\phi 0.5$ mm $\phi 0.020$ in approx.

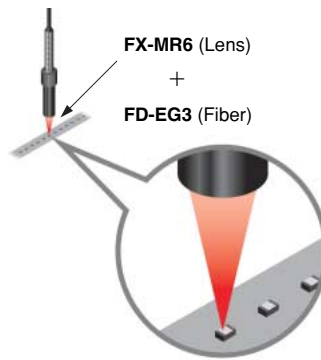

0603 chip orientation discrimination

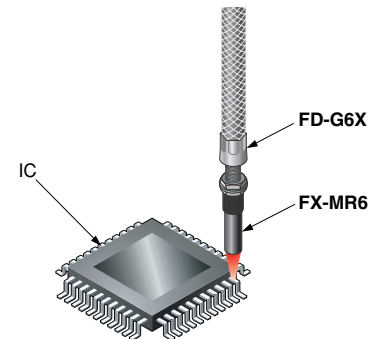

IC pin sensing

Ultra small diameter fiber

FT-E12/E22, FD-E12/E22

Sleeve head diameter of 0.25 mm 0.010 in has been realized (FT-E12). This has improved the sensing capability for minute objects such as the 0603 chip.

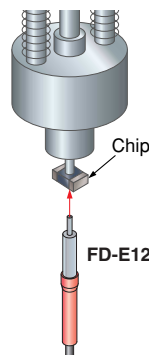

Sensing of chip components during suction transport

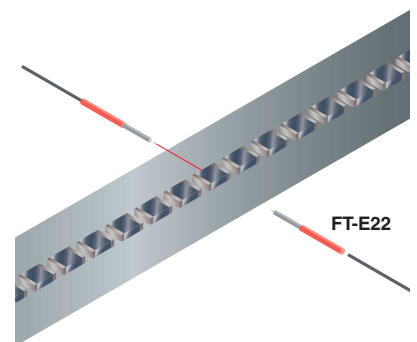

Confirming passage of chip components

Rectangular head fiber

FT-Z8□/WZ8□

The allowable bending radius is 4 mm 0.157 in (1 mm 0.039 in for the FT-WZ8□). This allows the fibers to be routed with great freedom and uses less space. Because it is installed with only two M2 screws, light beam axis alignment is easy. A front sensing type, side sensing type and top sensing type are provided.



Detecting ICs in transparent stick

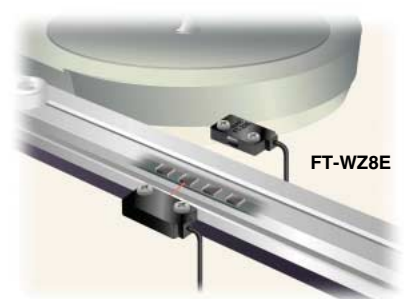

Parts feeder surplus detection

Retroreflective type fiber

FR-WKZ11, FR-KZ21/22

The lineup includes retroreflective type fibers which are ideal for sensing transparent objects.

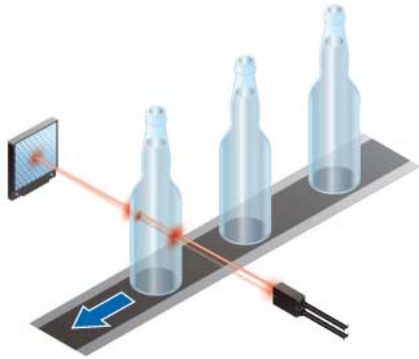

With polarizing filters FR-WKZ11

This fiber has a compact head of $W9.5 \times H5.2 \times D15$ mm $W0.374 \times H0.205 \times D0.591$ in. Equipped with allowable bending radius: R1 mm $R0.039$ in making it space efficient.

Side-view fiber

FT-V10

Because this is a side-view fiber, it is ideal for sensing in locations where space is scarce. Has a 4-side beveled shape and beam axis alignment with respect to the beveled surface is done when installing the product, so that the fiber can be installed easily just by aligning its surface.

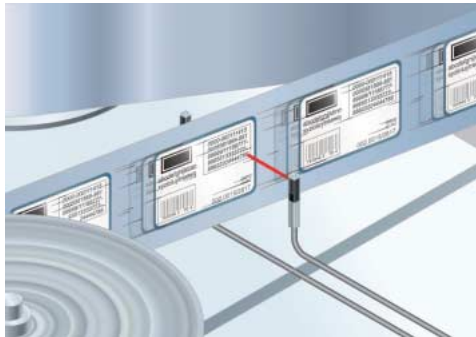

Chemical-resistant fiber

FT-Z802Y

With the case made of PFA (fluorine resin) and fiber sheath with PFA (fluorine resin), the fiber can be used with various types of chemical liquids.

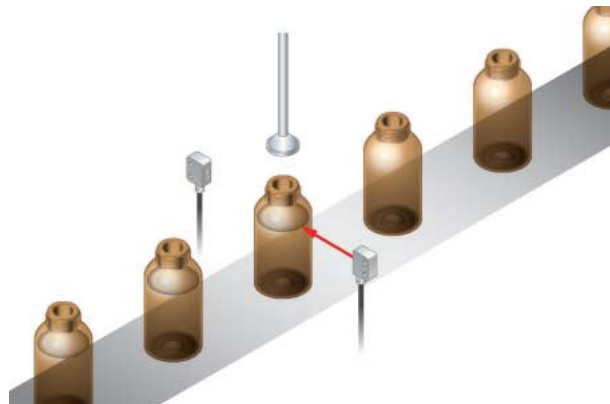

Tough flexible fiber

FT-P81X, FD-P81X, FD-G6X

Stainless steel braiding protects the fiber cable and prevents fiber breakage due to snagging.

R10 mm $R0.394$ in or more

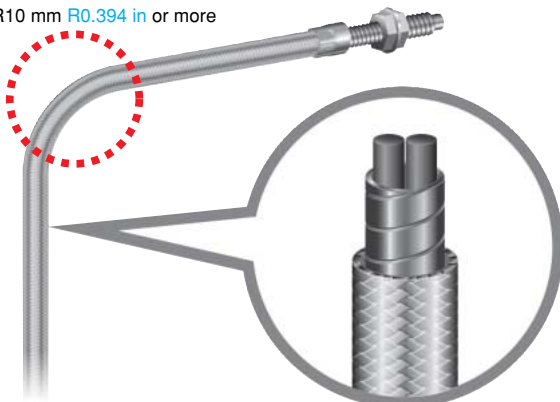

Strong stainless steel mesh protects fiber cables from breakage

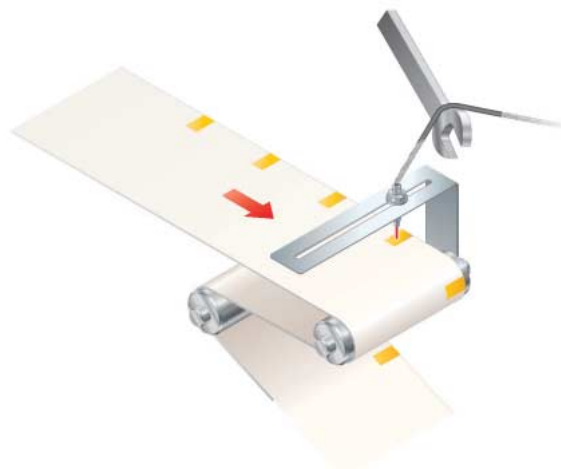

ORDER GUIDE

Connector type amplifiers **Quick-connection cable is not supplied with the amplifier. Please order it separately.**

Type	Appearance	Model No.	Emitting element	Output	Quick-connection cables					
					Type	Model No.	Length			
Standard type		FX-301	Red LED	NPN open-collector transistor	Main cable (3-core)	CN-73-C1	1 m 3.281 ft			
		FX-301P		PNP open-collector transistor		CN-73-C2	2 m 6.562 ft			
		FX-301B	Blue LED	NPN open-collector transistor		Sub cable (1-core)	CN-73-C5	5 m 16.404 ft		
		FX-301BP		PNP open-collector transistor			CN-71-C1	1 m 3.281 ft		
		FX-301G	Green LED	NPN open-collector transistor			CN-71-C2	2 m 6.562 ft		
		FX-301GP		PNP open-collector transistor		CN-71-C5	5 m 16.404 ft			
		High-speed type		FX-301-HS		Red LED	NPN open-collector transistor	Sub cable (2-core)	CN-72-C1	1 m 3.281 ft
				FX-301P-HS			PNP open-collector transistor		CN-72-C2	2 m 6.562 ft
High-function type		FX-305	Red LED	NPN open-collector transistor	Main cable (4-core)	CN-74-C1	1 m 3.281 ft			
				PNP open-collector transistor		CN-74-C2	2 m 6.562 ft			
				CN-74-C5		5 m 16.404 ft				
		FX-305P		NPN open-collector transistor	Sub cable (2-core)	CN-72-C1	1 m 3.281 ft			
				PNP open-collector transistor		CN-72-C2	2 m 6.562 ft			
				CN-72-C5		5 m 16.404 ft				

ORDER GUIDE

Quick-connection cables

For FX-301(-HS)/B/G/H **Quick-connection cable is not supplied with the amplifier. Please order it separately.**

Type	Model No.	Description	
Main cable (3-core)	CN-73-C1	Length: 1 m 3.281 ft	0.15 mm ² 3-core cabtyre cable, with connector on one end Cable outer diameter: ϕ 3.0 mm ϕ 0.118 in
	CN-73-C2	Length: 2 m 6.562 ft	
	CN-73-C5	Length: 5 m 16.404 ft	
Sub cable (1-core)	CN-71-C1	Length: 1 m 3.281 ft	0.15 mm ² 1-core cabtyre cable, with connector on one end Cable outer diameter: ϕ 3.0 mm ϕ 0.118 in
	CN-71-C2	Length: 2 m 6.562 ft	
	CN-71-C5	Length: 5 m 16.404 ft	

Main cable
• **CN-73-C□**

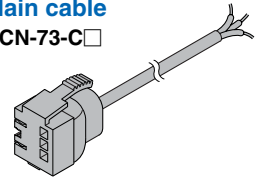

Sub cable
• **CN-71-C□**

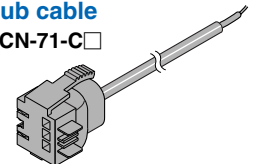

For FX-305 **Quick-connection cable is not supplied with the amplifier. Please order it separately.**

Type	Model No.	Description	
Main cable (4-core)	CN-74-C1	Length: 1 m 3.281 ft	0.15 mm ² 4-core cabtyre cable, with connector on one end Cable outer diameter: ϕ 3.0 mm ϕ 0.118 in
	CN-74-C2	Length: 2 m 6.562 ft	
	CN-74-C5	Length: 5 m 16.404 ft	
Sub cable (2-core)	CN-72-C1	Length: 1 m 3.281 ft	0.15 mm ² 2-core cabtyre cable, with connector on one end Cable outer diameter: ϕ 3.0 mm ϕ 0.118 in
	CN-72-C2	Length: 2 m 6.562 ft	
	CN-72-C5	Length: 5 m 16.404 ft	

Main cable
• **CN-74-C□**

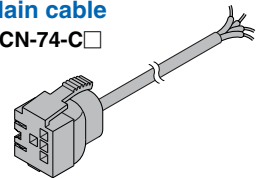

Sub cable
• **CN-72-C□**

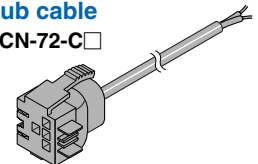

End plates **End plates are not supplied with the amplifier. Please order them separately when the amplifiers are mounted in cascade.**

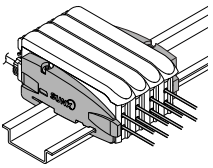
Appearance	Model No.	Description
	MS-DIN-E	When cascading multiple amplifiers, or when it moves depending on the way it is installed on a DIN rail, these end plates ensure that all amplifiers are mounted together in a secure and fully connected manner. Two pcs. per set

OPTIONS

Designation	Model No.	Description
Amplifier mounting bracket	MS-DIN-2	Mounting bracket for amplifier
Fiber amplifier protective seal	FX-MB1	10 sets of 2 communication window seals and 1 connector seal Communication window seal: It prevents malfunction due to transmission signal from another amplifier, as well as, prevents effect on another amplifier. Connector seal: It prevents contact of any metal, etc., with the pins of the quick-connection cable.

Amplifier mounting bracket
• **MS-DIN-2**

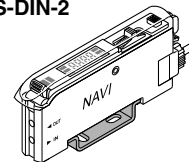

Fiber amplifier protective seal
• **FX-MB1**

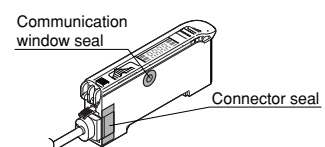

LIST OF FIBERS

Pliable fibers (flexible and sharp bending fibers) are marked with light blue in the table.

FX-305 / FX-301 (Red LED type) sensing range (Note 1)

Thru-beam type (one pair set)



The FX-305 and FX-301(-HS) have different sensing modes.
 FX-305: H-SP, FAST, STD, STDF, LONG, U-LG (no S-D mode)
 FX-301(-HS): S-D, H-SP, FAST, STD, LONG (no STDF or U-LG mode)

Type	Shape of fiber head (mm in)	Sensing range (mm in)(Note 2)	■ U-LG ■ FAST ■ LONG ■ H-SP ■ STDF ■ S-D ■ STD	Min. sensing object (Note 3)	Fiber cable length ✂ Free-cut	Bending radius	Model No.		
Thru-beam type	M4	Lens mountable	1,600 62.992 1,100 43.307 700 27.559 530 20.866	400 15.748 200 7.874 180 7.087	φ 0.04 mm φ 0.0016 in opaque object	2 m 6.562 ft	R25 mm R0.984 in	FT-B8	
		Lens mountable							FT-FM2
		Sleeve 90 mm 3.543 in	1,000 39.370 780 30.709 500 19.685 400 15.748	280 11.024 150 5.906 130 5.118	φ 0.03 mm φ 0.0012 in opaque object		Fiber R25 mm R0.984 in Sleeve R10 mm R0.394 in		FT-FM2S
		Sleeve 40 mm 1.575 in							FT-FM2S4
		Lens mountable	750 29.528 570 22.441 350 13.780 290 11.417	200 7.874 90 3.543 100 3.937	φ 0.03 mm φ 0.0012 in opaque object		R1 mm R0.039 in		FT-W8
		Lens mountable	900 35.433 650 25.591 400 15.748 320 12.598	230 9.055 100 3.937 110 4.331	φ 0.04 mm φ 0.0016 in opaque object		R4 mm R0.157 in Flexible		FT-P80
		Lens mountable	900 35.433 650 25.591 380 14.961 320 12.598	230 9.055 100 3.937 110 4.331	φ 0.05 mm φ 0.0020 in opaque object		1 m 3.281 ft	R10 mm R0.394 in	FT-P81X
		Lens mountable Tough flexible	550 21.654 400 15.748 250 9.843 190 7.480	140 5.512 70 2.756 80 3.150	φ 0.04 mm φ 0.0016 in opaque object		2 m 6.562 ft	R4 mm R0.157 in Flexible	FT-P60
	Nut type	W7 × H9 × D13.9 W0.276 × H0.354 × D0.547	750 29.528 570 22.441 350 13.780 290 11.417	200 7.874 90 3.543 100 3.937	φ 0.06 mm φ 0.0024 in opaque object	2 m 6.562 ft	R1 mm R0.039 in	FT-WR80	
		With lens W7 × H9 × D14.6 W0.276 × H0.354 × D0.575	1,500 59.055 1,200 47.244 750 29.528 600 23.622	420 16.535 200 7.874 210 8.268	φ 0.04 mm φ 0.0016 in opaque object			FT-WR80L	
	Elbow	Lens mountable	740 29.134 530 20.866 320 12.598 230 9.055	150 5.906 75 2.953 80 3.150	φ 0.04 mm φ 0.0016 in opaque object	2 m 6.562 ft	R25 mm R0.984 in	FT-R80	
	M3	Lens mountable (except FX-LE2)	1,000 39.370 780 30.709 500 19.685 400 15.748	280 11.024 150 5.906 130 5.118	φ 0.03 mm φ 0.0012 in opaque object	2 m 6.562 ft	R25 mm R0.984 in	FT-T80	
		Lens mountable							FT-NFM2
		Sleeve 90 mm 3.543 in	400 15.748 270 10.630 200 7.874 140 5.512	100 3.937 55 2.165 49 1.929	φ 0.025 mm φ 0.0010 in opaque object		Fiber R25 mm R0.984 in Sleeve R10 mm R0.394 in		FT-NFM2S
Sleeve 40 mm 1.575 in								FT-NFM2S4	
Lens mountable		220 8.661 160 6.299 100 3.937 80 3.150	55 2.165 25 0.984 28 1.102	φ 0.02 mm φ 0.0008 in opaque object	R1 mm R0.039 in			FT-W4	
Lens mountable		350 13.780 250 9.843 150 5.906 100 3.937	75 2.953 30 1.181 35 1.378		R4 mm R0.157 in Flexible			FT-P40	
With lens		19,500 767.715 19,500 767.715 19,500 767.715 14,000 551.180	10,000 393.700 3,500 137.795 3,800 149.606	φ 0.4 mm φ 0.016 in opaque object	10 m 32.808 ft		R25 mm R0.984 in	FT-FM10L	

- Notes: 1) Refer to p.27 for the sensing ranges for the FX-301(-HS) in H-SP mode and for the FX-301B/G/H.
 2) Please take care that the sensing range of the free-cut type fiber may be reduced by 20 % max. depending upon how the fiber is cut.
 3) The minimum sensing object size is the value for red LED type. Please contact our office for information on the minimum sensing object size if using amplifiers other than red LED type.
 The optimum condition is the condition when the sensitivity is set so that the sensing output just changes to light incident operation in the object absent condition.

LIST OF FIBERS

Pliable fibers (flexible and sharp bending fibers) are marked with light blue in the table.

FX-305 / FX-301 (Red LED type) sensing range (Note 1)

Thru-beam type (one pair set)



The FX-305 and FX-301(-HS) have different sensing modes.
 FX-305: H-SP, FAST, STD, STDF, LONG, U-LG (no S-D mode)
 FX-301(-HS): S-D, H-SP, FAST, STD, LONG (no STDF or U-LG mode)

Type	Shape of fiber head (mm in)	Sensing range (mm in)(Note 2)	■ : U-LG ■ : FAST ■ : LONG ■ : H-SP ■ : STDF ■ : S-D ■ : STD	Min. sensing object (Note 3)	Fiber cable length ✂ Free-cut	Bending radius	Model No.		
Cylindrical type	φ3 φ0.118	With lens · Long sensing range	1,500 59.055	420 16.535	φ0.02 mm φ0.0008 in opaque object	✂ 2 m 6.562 ft	R1 mm R0.039 in	FT-WS8L	
			1,200 47.244	200 7.874					
			750 29.528	210 8.268					
			600 23.622						
			780 30.709	200 7.874					
			340 13.386	90 3.543					
	φ2.5 φ0.098	With lens · Long sensing range	φ2.5 φ0.098	2,000 78.740	580 22.835	φ0.02 mm φ0.0008 in opaque object	✂ 2 m 6.562 ft	R25 mm R0.984 in	FT-SFM2L
				1,600 62.992	170 6.693				
				600 23.622	280 11.024				
				800 31.496					
				1,000 39.370	280 11.024				
				780 30.709	150 5.906				
φ1.5 φ0.059	With lens · Long sensing range	φ1.5 φ0.059	400 15.748	100 3.937	φ0.025 mm φ0.0010 in opaque object	✂ 2 m 6.562 ft	R25 mm R0.984 in	FT-SNFM2	
			270 10.630	55 2.165					
			200 7.874	49 1.929					
			140 5.512						
			220 8.661	55 2.165					
			160 6.299	25 0.984					
φ1 φ0.039	With lens · Long sensing range	φ1 φ0.039	350 13.780	90 3.543	φ0.02 mm φ0.0008 in opaque object	✂ 1 m 3.281 ft	R1 mm R0.039 in	FT-WS4	
			280 11.024	40 1.575					
			160 6.299	42 1.654					
			120 4.724						
			100 3.937	30 1.181					
			80 3.150	13 0.512					
Ultra-small diameter	Beam diameter φ0.125 mm φ0.005 in	φ0.25 φ3	20 0.787	8 0.315	φ0.02 mm φ0.0008 in opaque object	✂ 500 mm 19.685 in	R5 mm R0.197 in	FT-E12	
		φ0.010 φ0.018	18 0.709	13 0.512					
			13 0.512	3 0.118					
			10 0.394						
			130 5.118	36 1.417					
			80 3.150	18 0.709					
Side-view	φ4 φ0.157	φ1 φ0.039	2,350 92.520	800 31.496	φ0.05 mm φ0.0020 in opaque object	✂ 2 m 6.562 ft	R25 mm R0.984 in	FT-V10	
			2,000 78.740	340 13.386					
			1,400 55.118	350 13.780					
			1,000 39.370						
			550 21.654	140 5.512					
			400 15.748	65 2.559					
	φ1.5 φ0.059	φ1.5 φ0.059	φ1.5 φ0.059	400 15.748	140 5.512	φ0.02 mm φ0.0008 in opaque object	✂ 1 m 3.281 ft	R25 mm R0.984 in	FT-SFM2SV2
				400 15.748	65 2.559				
				240 9.449	70 2.756				
				200 7.874					
				410 16.142	125 4.921				
				390 15.354	60 2.362				
φ1 φ0.039	φ1 φ0.039	φ1 φ0.039	220 8.661	60 2.362	φ0.02 mm φ0.0008 in opaque object	✂ 2 m 6.562 ft	R1 mm R0.039 in	FT-V22	
			175 6.890	25 0.984					
			100 3.937	27 1.063					
			80 3.150						
			220 8.661	60 2.362					
			175 6.890	25 0.984					

Notes: 1) Refer to p.27 for the sensing ranges for the FX-301(-HS) in H-SP mode and for the FX-301B/G/H.
 2) Please take care that the sensing range of the free-cut type fiber may be reduced by 20 % max. depending upon how the fiber is cut.
 3) The minimum sensing object size is the value for red LED type. Please contact our office for information on the minimum sensing object size if using amplifiers other than red LED type.
 The optimum condition is the condition when the sensitivity is set so that the sensing output just changes to light incident operation in the object absent condition.

LIST OF FIBERS

Pliable fibers (flexible and sharp bending fibers) are marked with light blue in the table.

FX-305 / FX-301 (Red LED type) sensing range (Note 1)

Thru-beam type (one pair set)



The FX-305 and FX-301 (-HS) have different sensing modes.
 FX-305: H-SP, FAST, STD, STDF, LONG, U-LG (no S-D mode)
 FX-301 (-HS): S-D, H-SP, FAST, STD, LONG (no STDF or U-LG mode)

Type	Shape of fiber head (mm in)	Sensing range (mm in) (Note 2)	■ U-LG ■ FAST ■ LONG ■ H-SP ■ STDF ■ S-D ■ STD	Min. sensing object (Note 3)	Fiber cable length ✂ Free-cut	Bending radius	Model No.		
Rectangular	Compact	Easy mounting · Top sensing W3 × H8 × D12 W0.118 × H0.315 × D0.472	3,500 137.795	850 33.465	φ 0.08 mm φ 0.0032 in opaque object	2 m 6.562 ft	R1 mm R0.039 in	FT-WZ8H	
			2,500 98.425	400 15.748					
		1,600 62.992	410 16.142	φ 0.03 mm φ 0.0012 in opaque object	R4 mm R0.157 in		FT-Z8H		
		1,200 47.244							
		Easy mounting · Side sensing W3 × H12 × D8 W0.118 × H0.472 × D0.315	2,100 82.677	500 19.685	φ 0.05 mm φ 0.0020 in opaque object		R1 mm R0.039 in	FT-WZ8E	
	1,500 59.055		200 7.874						
	Easy mounting · Front sensing W8.5 × H12 × D3 W0.335 × H0.472 × D0.118	950 37.402	240 9.449	φ 0.04 mm φ 0.0016 in opaque object	R1 mm R0.039 in	FT-WZ8			
		700 27.559	100 3.937						
	Special	Wide beam	Top sensing W5 × H15 × D15 W0.197 × H0.591 × D0.591	850 33.465	220 8.661	Horizontal: φ 0.025 mm φ 0.0010 in opaque object	2 m 6.562 ft	R25 mm R0.984 in	FT-AFM2
				650 25.591	100 3.937				
Side sensing W5 × H15 × D15 W0.197 × H0.591 × D0.591			800 31.496	200 7.874	Vertical: φ 0.45 mm φ 0.018 in opaque object	R10 mm R0.394 in		FT-AFM2E	
			350 13.780	100 3.937					
Narrow beam			Wide area sensing Sensing width 32 mm 1.260 in W5 × H69 × D20 W0.197 × H2.717 × D0.787	(Note 4) 3,500 137.795	(Note 4) 3,500 137.795	φ 0.3 mm φ 0.012 in opaque object		2 m 6.562 ft	R1 mm R0.039 in
		(Note 4) 3,500 137.795		(Note 4) 3,000 118.110					
		Wide area sensing Sensing width 11 mm 0.433 in W4.2 × H31 × D13.5 W0.165 × H1.220 × D0.531	(Note 4) 3,500 137.795	1,100 43.307	φ 0.25 mm φ 0.010 in opaque object	R1 mm R0.039 in	FT-WA8		
			(Note 4) 3,500 137.795	1,080 42.520					
		1,500 59.055	750 29.528	R10 mm R0.394 in	FT-A8				

- Notes: 1) Refer to p.27 for the sensing ranges for the FX-301-HS in H-SP mode and for the FX-301B/G/H.
 2) Please take care that the sensing range of the free-cut type fiber may be reduced by 20 % max. depending upon how the fiber is cut.
 3) The minimum sensing object size is the value for red LED type. Please contact our office for information on the minimum sensing object size if using amplifiers other than red LED type.
 The optimum condition is the condition when the sensitivity is set so that the sensing output just changes to light incident operation in the object absent condition.
 4) The fiber cable length practically limits the sensing range to 3,500 mm 137.795 in long.

LIST OF FIBERS

FX-305 / FX-301 (Red LED type) sensing range (Note 1)

Thru-beam type (one pair set)



The FX-305 and FX-301 (-HS) have different sensing modes.
 FX-305: H-SP, FAST, STD, STDF, LONG, U-LG (no S-D mode)
 FX-301 (-HS): S-D, H-SP, FAST, STD, LONG (no STDF or U-LG mode)

Type	Shape of fiber head (mm in)	Sensing range (mm in)(Note 2)	■ : U-LG ■ : LONG ■ : STDF ■ : STD ■ : FAST ■ : H-SP ■ : S-D	Min. sensing object (Note 3)	Fiber cable length ✂ : Free-cut	Bending radius	Model No.				
Heat-resistant	350 °C 662 °F Lens mountable 		■ 750 29.528 ■ 550 21.654 ■ 330 12.992 ■ 280 11.024	■ 200 7.874 ■ 85 3.346 ■ 90 3.543	φ0.04 mm φ0.0016 in opaque object	2 m 6.562 ft ✂ : Free-cut	R25 mm R0.984 in	FT-H35-M2			
		350 °C 662 °F Sleeve 60 mm 2.362 in M4 		■ 420 16.535 ■ 310 12.205 ■ 180 7.087 ■ 140 5.512			■ 100 3.937 ■ 40 1.575 ■ 50 1.969	φ0.02mm φ0.0008 in opaque object	1 m 3.281 ft ✂ : Free-cut	Fiber R25 mm R0.984 in Sleeve R10 mm R0.394 in	FT-H35-M2S6
	Allows flexible wiring 200 °C 392 °F Lens mountable 		■ 750 29.528 ■ 550 21.654 ■ 320 12.598 ■ 280 11.024	■ 200 7.874 ■ 85 3.346 ■ 90 3.543	φ0.04 mm φ0.0016 in opaque object	1 m 3.281 ft ✂ : Free-cut	R25 mm R0.984 in			FT-H20-M1	
		130 °C 266 °F Lens mountable (FX-LE2 only) 		■ 1,200 47.244 ■ 880 34.646 ■ 550 21.654 ■ 440 17.323			■ 300 11.811 ■ 150 5.906 ■ 155 6.102	φ0.06 mm φ0.0024 in opaque object	2 m 6.562 ft ✂ : Free-cut	R25 mm R0.984 in	FT-H13-FM2
	Special	Lens mountable (FX-LE1) 		■ 530 20.866 ■ 390 15.354 ■ 225 8.858 ■ 200 7.874	■ 140 5.512 ■ 60 2.362 ■ 60 2.362	φ0.12 mm φ0.005 in opaque object	✂ : Free-cut 200 mm 7.874 in (Note 4) ✂ : Free-cut 300 mm 11.811 in (Note 4) ✂ : Free-cut 500 mm 19.685 in (Note 4)			Heat-resistant fiber R18 mm R0.709 in (Note 5)	FT-H20-J20-S (Note 6) NEW
			Side-view 		■ 840 33.071 ■ 550 21.654 ■ 370 14.567 ■ 280 11.024			■ 200 7.874 ■ 90 3.543 ■ 90 3.543	φ0.16 mm φ0.006 in opaque object		✂ : Free-cut 500 mm 19.685 in (Note 4) ✂ : Free-cut 800 mm 31.496 in (Note 4)
Side-view 				■ 840 33.071 ■ 550 21.654 ■ 370 14.567 ■ 280 11.024	■ 200 7.874 ■ 90 3.543 ■ 90 3.543			FT-H20-VJ50-S (Note 6) NEW			
Chemical-resistant		Easy mounting - Rectangular head SEMI S2 compliant W7 × H15 × D13 W0.276 × H0.591 × D0.512 		■ 3,500 137.795 ■ 3,500 137.795 ■ 3,000 118.110 ■ 1,500 59.055	■ 1,000 39.370 ■ 500 19.685 ■ 530 20.866	φ4 mm φ0.157 in opaque object	✂ : Free-cut 2 m 6.562 ft	R25 mm R0.984 in	FT-Z802Y		
			Side-view 		■ 3,500 137.795 ■ 3,500 137.795 ■ 2,000 78.740 ■ 1,500 59.055			■ 1,000 39.370 ■ 500 19.685 ■ 530 20.866	φ0.2 mm φ0.008 in opaque object	✂ : Free-cut 2 m 6.562 ft (Note 7)	R30 mm R1.181 in
Vacuum-resistant	300 °C 572 °F Lens mountable (FV-LE1/SV2 only) 		■ 350 13.780 ■ 250 9.843 ■ 150 5.906 ■ 125 4.921	■ 90 3.543 ■ 50 1.969 ■ 40 1.575	φ0.03 mm φ0.0012 in opaque object	1 m 3.281 ft ✂ : Free-cut	R18 mm R0.709 in	FT-H30-M1V-S (Note 8)			

- Notes: 1) Please contact our office for the sensing ranges for the FX-301-HS in H-SP mode and for the FX-301B/G/H.
 2) Please take care that the sensing range of the free-cut type fiber may be reduced by 20 % max. depending upon how the fiber is cut.
 3) The minimum sensing object size is the value for red LED type. Please contact our office for information on the minimum sensing object size if using amplifiers other than red LED type.
 The optimum condition is the condition when the sensitivity is set so that the sensing output just changes to light incident operation in the object absent condition.
 4) This is the fiber length (fixed length) for heat-resistant fibers. The ordinary-temperature fibers are free-cut to 2 m 6.562 ft.
 5) The ordinary-temperature fiber is R25 mm R0.984 in or more.
 6) Heat-resistant joint fibers and ordinary-temperature fibers (FT-FM2) are sold as a set. Please refer to 'Heat-resistant joint fibers catalog' for details.
 7) The allowable cutting range is 500 mm 19.685 in from the end that the amplifier inserted.
 8) Sold as a set comprising vacuum type fiber + photo-terminal (FV-BR1) + fiber at atmospheric side (FT-J8). Please refer to 'Vacuum resistant fiber catalog' for details.

Model No. when ordering heat-resistant joint fibers individually as replacement parts

- FT-H20-J20 (one pair set)
- FT-H20-J30 (one pair set)
- FT-H20-J50 (one pair set)
- FT-H20-VJ50 (one pair set)
- FT-H20-VJ80 (one pair set)

Model No. when ordering vacuum-resistant fibers individually as replacement parts

- Vacuum-resistant fiber
FT-H30-M1V (one pair set)
- Photo-terminal
FV-BR1 (one pair set)
- Fiber at atmospheric side
FT-J8 (one pair set)

LIST OF FIBERS

Pliable fibers (flexible and sharp bending fibers) are marked with light blue in the table.

FX-305 / FX-301 (Red LED type) sensing range (Note 1)

Retroreflective type



The FX-305 and FX-301 (-HS) have different sensing modes.
 FX-305: H-SP, FAST, STD, STDF, LONG, U-LG (no S-D mode)
 FX-301(-HS): S-D, H-SP, FAST, STD, LONG (no STDF or U-LG mode)

Type	Shape of fiber head (mm in)	Sensing range (mm in)(Note 2, 3)	Legend	Min. sensing object (Note 4)	Fiber cable length	Bending radius	Model No.
Sharp bending With polarizing filters	W9.5 X H5.2 X D15 W0.374 X H0.205 X D0.591 W30 X H30 X D0.5 W1.181 X H1.181 X D0.020	100 to 910 3.937 to 35.827 100 to 730 3.937 to 28.740 100 to 600 3.937 to 23.622 100 to 520 3.937 to 20.472	U-LG, LONG, STDF, STD, FAST, H-SP, S-D	φ 0.3 mm φ 0.012 in opaque object	2 m 6.562 ft	R1 mm R0.039 in	FR-WKZ11
Narrow beam Side sensing	Top sensing W9.5 X H5.2 X D21 W0.374 X H0.205 X D0.827 W10.6 X H28 X D10.1 W0.417 X H1.102 X D0.398	200 7.874 200 7.874 200 7.874	FAST, H-SP, S-D	Horizontal: φ 5.5 mm φ 0.217 in opaque object Vertical: φ 0.06 mm φ 0.0024 in opaque object	2 m 6.562 ft	R10 mm R0.394 in	FR-KZ21 FR-KZ21E
	Side sensing W9.5 X H25 X D5.2 W0.374 X H0.984 X D0.205 W10.6 X H28 X D10.1 W0.417 X H1.102 X D0.398	200 7.874	FAST, H-SP, S-D				
Wafer mapping	W7.5 X H2.2 X D11.2 W0.295 X H0.087 X D0.441 W4 X H2 X D21.5 W0.157 X H0.079 X D0.846	15 to 370 0.591 to 14.567 15 to 330 0.591 to 12.992 15 to 240 0.591 to 9.449 15 to 210 0.591 to 8.268	FAST, H-SP, S-D	φ 0.12 mm φ 0.005 in opaque object	2 m 6.562 ft	R10 mm R0.394 in	FR-KV1

- Notes: 1) Please contact our office for the sensing ranges for the FX-301-HS in H-SP mode and for the FX-301B/G/H.
 2) Please take care that the sensing range of the free-cut type fiber may be reduced by 20 % max. depending upon how the fiber is cut. The sensing range of FR-WKZ11 is specified for the RF-13. The sensing range of FR-KZ21, FR-KZ21E and FR-KV1 is specified for the attached reflector.
 3) The sensing range of FR-WKZ11 is the possible setting range for the reflector or reflective tape. The fiber can detect an object less than 100 mm 3.937 in away. However, note that if there are any white or highly-reflective surfaces near the fiber head, reflected incident light may affect the fiber head. If this occurs, adjust the threshold value of the amplifier unit before use. The sensing range of FR-KZ21(E) is the possible setting range for the reflector. However, if setting the fiber to detect objects passing within 0 to 20 mm 0 to 0.787 in from the fiber head, unstable detection may result. The sensing range of FR-KV1 is the possible setting range for the reflector. The fiber can detect an object less than 15 mm 0.591 in away.
 4) The minimum sensing object size is the value for red LED type. The optimum condition is the condition when the sensitivity is set so that the sensing output just changes to light incident operation in the object absent condition.

FX-305 / FX-301 (Red LED type) sensing range (Note 1)

Reflective type



The FX-305 and FX-301 (-HS) have different sensing modes.
 FX-305: H-SP, FAST, STD, STDF, LONG, U-LG (no S-D mode)
 FX-301(-HS): S-D, H-SP, FAST, STD, LONG (no STDF or U-LG mode)

Type	Shape of fiber head (mm in)	Sensing range (mm in)(Note 2, 3)	Legend	Min. sensing object (Note 4)	Fiber cable length	Bending radius	Model No.	
Threaded type M6	M6	600 23.622 480 18.898 280 11.024 220 8.661	FAST, H-SP, S-D	160 6.299 85 3.346 75 2.953		R25 mm R0.984 in	FD-B8	
	Coaxial M6	410 16.142 310 12.205 200 7.874 140 5.512	FAST, H-SP, S-D	100 3.937 55 2.165 47 1.850			FD-FM2	
	Sleeve 90 mm 3.543 in M6 φ2.5 φ0.098	370 14.567 270 10.630	FAST, H-SP, S-D	85 3.346 45 1.772 39 1.535	φ 0.02 mm φ 0.0008 in gold wire	2 m 6.562 ft	R25 mm R0.984 in Sleeve R10 mm R0.394 in	FD-FM2S FD-FM2S4
	Sleeve 40 mm 1.575 in M6 φ2.5 φ0.098	250 9.843 190 7.480 110 4.331 90 3.543	FAST, H-SP, S-D	60 2.362 25 0.984 32 1.260			R1 mm R0.039 in	FD-W8
	M6	300 11.811 220 8.661 130 5.118 100 3.937	FAST, H-SP, S-D	70 2.756 30 1.181 35 1.378			R4 mm R0.157 in Flexible	FD-P80
	M6	270 10.630 185 7.283 100 3.937 80 3.150	FAST, H-SP, S-D	60 2.362 30 1.181 35 1.378		1 m 3.281 ft	R10 mm R0.394 in	FD-P81X
	Tough flexible							
	Elbow	M6	240 9.449 185 7.283 110 4.331 85 3.346	FAST, H-SP, S-D	60 2.362 25 0.984 30 1.181	φ 0.02 mm φ 0.0008 in gold wire	R25 mm R0.984 in	FD-R80

- Notes: 1) Refer to p.27 for the sensing ranges for the FX-301-HS in H-SP mode and for the FX-301B/G/H.
 2) The sensing range is specified for white non-glossy paper [400 × 400 mm 15.748 × 15.748 in] as the object.
 3) Please take care that the sensing range of the free-cut type fiber may be reduced by 20 % max. depending upon how the fiber is cut.
 4) The minimum sensing object size is the value for red LED type at maximum sensitivity. Note that the corresponding setting distance is different from the rated sensing distance.

LIST OF FIBERS

Pliable fibers (flexible and sharp bending fibers) are marked with light blue in the table.

FX-305 / FX-301 (Red LED type) sensing range (Note 1)

Reflective type 

The FX-305 and FX-301(-HS) have different sensing modes.
 FX-305: H-SP, FAST, STD, STDF, LONG, U-LG (no S-D mode)
 FX-301(-HS): S-D, H-SP, FAST, STD, LONG (no STDF or U-LG mode)

Type	Shape of fiber head (mm in)	Sensing range (mm in)(Note 2, 3)	■ : U-LG ■ : FAST ■ : LONG ■ : H-SP ■ : STDF ■ : S-D ■ : STD	Min. sensing object (Note 4)	Fiber cable length  Free-cut	Bending radius	Model No.
Threaded type	M4	370 14.567 270 10.630 170 6.693 110 4.331	85 3.346 45 1.772 39 1.535			R25 mm R0.984 in	FD-T80
	M4						FD-NFM2
	Sleeve 90 mm 3.543 in M4	140 5.512 90 3.543 60 2.362 45 1.772	35 1.378 16 0.630 16 0.630			Fiber R25 mm R0.984 in Sleeve R10 mm R0.394 in	FD-NFM2S
	Sleeve 40 mm 1.575 in M4						FD-NFM2S4
	Sleeve 40 mm 1.575 in M4	40 1.575 30 1.181 18 0.709 15 0.591	12 0.472 4.5 0.177 5 0.197		φ0.02 mm φ0.0008 in gold wire	Fiber R1 mm R0.039 in Sleeve R10 mm R0.394 in	FD-W44
	M4	250 9.843 190 7.480 110 4.331 90 3.543	60 2.362 25 0.984 32 1.260			R1 mm R0.039 in	FD-WT8
	Coaxial · Lens mountable M4	85 3.346 65 2.559 37 1.457 32 1.260	25 0.984 10 0.394 11 0.433			R2 mm R0.079 in	FD-WG4
	M4	150 5.906 110 4.331 65 2.559 55 2.165	42 1.654 15 0.591 19 0.748			R25 mm R0.984 in	FD-G4
	M4	130 5.118 90 3.543 55 2.165 45 1.772	30 1.181 13 0.512 16 0.630			R4 mm R0.157 in Flexible	FD-P60
	M3	140 5.512 90 3.543 60 2.362 45 1.772	35 1.378 16 0.630 16 0.630			R25 mm R0.984 in	FD-T40
M3	40 1.575 30 1.181 18 0.709 15 0.591	12 0.472 4.5 0.177 5 0.197			R1 mm R0.039 in	FD-WT4	
M3	50 1.969 36 1.417 20 0.787 18 0.709	14 0.551 5.5 0.217 6 0.236			R4 mm R0.157 in Flexible	FD-P40	
M3	150 5.906 110 4.331 65 2.559 55 2.165	42 1.654 15 0.591 19 0.748			R25 mm R0.984 in	FD-G6	
M3	150 5.906 90 3.543 48 1.890 45 1.772	35 1.378 12 0.472 20 0.787			R10 mm R0.394 in	FD-G6X	
M3	50 1.969 38 1.496 25 0.984 18 0.709	14 0.551 5 0.197 6 0.236			R25 mm R0.984 in	FD-EG1	
M3	40 1.575 25 0.984 14 0.551 12 0.472	9 0.354 3 0.118 5 0.197			500 mm 19.685 in	FD-EG2	
M3	20 0.787 15 0.591 9 0.354 8 0.315	5 0.197 2.5 0.098 3 0.118			R10 mm R0.394 in	FD-EG3	
M3	6.5 0.256 5 0.197 3 0.118	2 0.079 Cannot use Cannot use			R25 mm R0.984 in	FD-EN500S1	
M3	50 1.969 38 1.496 20 0.787 18 0.709	14 0.551 5 0.197 6 0.236			1 m 3.281 ft	FD-ENM1S1	

- Notes: 1) Refer to p.27 for the sensing ranges for the FX-301-HS in H-SP mode and for the FX-301B/G/H.
 2) The sensing range is specified for white non-glossy paper [200×200 mm 7.874×7.874 in (FD-T80, FD-WT8: 400×400 mm 15.748×15.748 in, FD-W44, FD-WT4, FD-P40, FD-G6, FD-EG1, FD-EG2, FD-EG3, FD-EN500S1, FD-ENM1S1: 100×100 mm 3.937×3.937 in)] as the object.
 3) Please take care that the sensing range of the free-cut type fiber may be reduced by 20 % max. depending upon how the fiber is cut.
 4) The minimum sensing object size is the value for red LED type at maximum sensitivity.
 Note that the corresponding setting distance is different from the rated sensing distance.
 5) The allowable cutting range is 700 mm 27.559 in from the end that the amplifier inserted.

LIST OF FIBERS

Pliable fibers (flexible and sharp bending fibers) are marked with light blue in the table.

FX-305 / FX-301 (Red LED type) sensing range (Note 1)

Reflective type



The FX-305 and FX-301(-HS) have different sensing modes.
 FX-305: H-SP, FAST, STD, STDF, LONG, U-LG (no S-D mode)
 FX-301(-HS): S-D, H-SP, FAST, STD, LONG (no STDF or U-LG mode)

Type	Shape of fiber head (mm in)	Sensing range (mm in)(Note 2, 3)	Min. sensing object (Note 4)	Fiber cable length Free-cut	Bending radius	Model No.		
Cylindrical type	φ3 φ0.118	370 14.567 270 10.630 170 6.693 110 4.331	85 3.346 45 1.772 39 1.535	φ0.02 mm φ0.0008 in gold wire	2 m 6.562 ft	R25 mm R0.984 in	FD-S80	
		250 9.843 190 7.480 110 4.331 90 3.543	60 2.362 25 0.984 32 1.260			R1 mm R0.039 in	FD-WS8	
		85 3.346 65 2.559 37 1.457 32 1.260	25 0.984 10 0.394 11 0.433			R2 mm R0.079 in	FD-WSG4	
		130 5.118 90 3.543 55 2.165 45 1.772	30 1.181 13 0.512 16 0.630			R4 mm R0.157 in	FD-P50	
		Flexible						
	φ2.5 φ0.098	140 5.512 90 3.543 60 2.362 45 1.772	35 1.378 16 0.630 16 0.630	φ0.02 mm φ0.0008 in gold wire	2 m 6.562 ft	R25 mm R0.984 in	FD-SNFM2	
	φ1.5 φ0.059	80 3.150 50 1.969 30 1.181 25 0.984	19 0.748 7.5 0.295 9 0.354	φ0.02 mm φ0.0008 in gold wire	1 m 3.281 ft	R4 mm R0.157 in	FD-P2	
	Ultra-small diameter	φ1.5 φ0.5 φ0.059 φ0.020	15 0.591 11 0.433 8 0.315 6 0.236	4 0.157 2 0.079 1 0.039	φ0.02 mm φ0.0008 in gold wire	1 m 3.281 ft	R10 mm R0.394 in	FD-E12
		Coaxial φ3 φ0.118	65 2.559 45 1.772	17 0.669 8 0.315 7 0.276			R25 mm R0.984 in	FD-E22
		φ0.65 φ0.026	23 0.906					
Sleeve part cannot be bent.								
Side-view	Small diameter φ1.5 φ0.059	80 3.150 55 2.165 30 1.181 25 0.984	17 0.669 8 0.315 9 0.354	φ0.02 mm φ0.0008 in gold wire	2 m 6.562 ft	R25 mm R0.984 in	FD-V41	
	φ3 φ0.118	20 0.787 15 0.591 8.5 0.335 7 0.276	5 0.197 Cannot use Cannot use			R1 mm R0.039 in	FD-WV42	
	φ4 φ0.118 φ0.079	170 6.693 100 3.937 55 2.165 45 1.772	32 1.260 15 0.591 16 0.630			R25 mm R0.984 in	FD-SFM2SV2	
	φ5 φ0.197 φ0.079							
Rectangular	Glass substrate detection · Mapping	W25 × H7.3 × D30 W0.984 × H0.287 × D1.181	12 to 50 0.472 to 1.969 12.5 to 37.5 0.492 to 1.476 15 to 36 0.591 to 1.417 15 to 35 0.591 to 1.378	16 to 29 0.630 to 1.142 Cannot use Cannot use	φ0.3 mm φ0.012 in gold wire	4 m 13.123 ft	R25 mm R0.984 in	FD-L46
		W20 × H29 × D3.8 W0.787 × H1.142 × D0.157	0 to 50 0 to 1.969 0 to 36 0 to 1.417 0 to 33 0 to 1.299 0 to 30 0 to 1.181	0 to 30 0 to 1.181 0 to 15 0 to 0.591 0 to 21 0 to 0.827	(LCD glass)	3 m 9.843 ft	R4 mm R0.157 in	FD-L45
	Glass substrate detection · Alignment	W17 × H29 × D3.8 W0.669 × H1.142 × D0.157	0 to 23 0 to 0.906			2 m 6.562 ft		FD-L43
		W12 × H19 × D3 W0.472 × H0.748 × D0.118	0 to 8.2 0 to 0.323 0 to 7 0 to 0.276 0 to 6.5 0 to 0.256 0 to 6 0 to 0.236 0 to 4.7 0 to 0.185 0 to 4.5 0 to 0.177 0 to 4 0 to 0.157 0 to 4 0 to 0.157	0 to 5.7 0 to 0.224 0 to 5 0 to 0.197 0 to 5.2 0 to 0.205 0 to 3.8 0 to 0.150 0 to 3 0 to 0.118 0 to 3.5 0 to 0.138	φ0.03 mm φ0.0012 in gold wire	2 m 6.562 ft	R10 mm R0.394 in	FD-L44 FD-L44S
	Convergent reflective type	Glass substrate detection	6.5 to 14.5 0.256 to 0.571 (Convergent point 8 0.315) 6.5 to 14 0.256 to 0.551 (Convergent point 8 0.315) 7 to 14 0.276 to 0.551 (Convergent point 8 0.315) 7 to 12 0.276 to 0.472 (Convergent point 8 0.315)	7.5 to 12 0.295 to 0.472 (Convergent point 8 0.315) Cannot use Cannot use	φ1.9 mm φ0.075 in metal pipe (gray)		R1 mm R0.039 in	FD-WL41
		W24 × H21 × D4 W0.945 × H0.827 × D0.157	2 to 19 0.079 to 0.748 (Convergent point 8 0.315) 2.5 to 18 0.098 to 0.709 (Convergent point 8 0.315) 3 to 16 0.118 to 0.630 (Convergent point 8 0.315) 3 to 16 0.118 to 0.630 (Convergent point 8 0.315)	3.5 to 15 0.138 to 0.591 (Convergent point 8 0.315) Cannot use Cannot use	φ0.06 mm φ0.024 in gold wire	2 m 6.562 ft	R10 mm R0.394 in	FD-L41
		W6 × H18 × D14 W0.236 × H0.709 × D0.551	2 to 20 0.079 to 0.787 (Convergent point 6 0.236) 2.5 to 18 0.098 to 0.709 (Convergent point 6 0.236) 4 to 12 0.157 to 0.472 (Convergent point 6 0.236) 4 to 12 0.157 to 0.472 (Convergent point 6 0.236)	4.5 to 11 0.177 to 0.433 (Convergent point 6 0.236) 1.5 to 8.5 0.197 to 0.335 (Convergent point 6 0.236) 1.8 to 9.5 0.189 to 0.374 (Convergent point 6 0.236)	φ0.02 mm φ0.0008 in gold wire			
		W7.2 × H7.5 × D2 W0.283 × H0.295 × D0.079	0.5 to 8.5 0.020 to 0.335 0.5 to 7.5 0.020 to 0.295 1 to 6.5 0.039 to 0.256 1 to 5.5 0.039 to 0.217	1 to 5 0.039 to 0.197 Cannot use Cannot use	φ0.3 mm φ0.012 in copper wire	1 m 3.281 ft	R1 mm R0.039 in	FD-WL48

- Notes: 1) Refer to p.27 for the sensing ranges for the FX-301-HS in H-SP mode and for the FX-301B/G/H.
 2) The sensing range is specified for white non-glossy paper (FD-S80, FD-WS8: 400 × 400 mm 15.748 × 15.748 in, FD-WSG4, FD-P50, FD-SNFM2, FD-V41, FD-SFM2SV2: 200 × 200 mm 7.874 × 7.874 in, FD-P2, FD-E12, FD-E22, FD-WV42, FD-L4, FD-WL48: 100 × 100 mm 3.937 × 3.937 in, FD-L46: 100 × 100 × t 0.7 mm 3.937 × 3.937 × t 0.028 in R edge of LCD glass substrates, FD-L43, FD-L44 and FD-L45: 100 × 100 × t 0.7 mm 3.937 × 3.937 × t 0.028 in LCD glass substrates, FD-L44S: silicon wafers polished surface, FD-WL41, FD-L41: 100 × 100 × t 2 mm 3.937 × 3.937 × t 0.079 in glass substrates).
 3) Please take care that the sensing range of the free-cut type fiber may be reduced by 20 % max. depending upon how the fiber is cut.
 4) The minimum sensing object size is the value for red LED type at maximum sensitivity. Note that the corresponding setting distance is different from the rated sensing distance. However, with the convergent reflective type, when the sensitivity is at MAX., it is only possible to detect the minimum size of the sensing object at a distance corresponding to the convergent point.



















LIST OF FIBERS

Pliable fibers (flexible and sharp bending fibers) are marked with light blue in the table.

FX-305 / FX-301 (Red LED type) sensing range (Note 1)

Reflective type 

The FX-305 and FX-301(-HS) have different sensing modes.
 FX-305: H-SP, FAST, STD, STDF, LONG, U-LG (no S-D mode)
 FX-301(-HS): S-D, H-SP, FAST, STD, LONG (no STDF or U-LG mode)

Type	Shape of fiber head (mm in)	Sensing range (mm in)(Note 2, 3)	■ : U-LG ■ : FAST ■ : LONG ■ : H-SP ■ : STDF ■ : S-D ■ : STD	Min. sensing object (Note 4)	Fiber cable length  Free-cut	Bending radius	Model No.	
Rectangular	Small	Front sensing  W10 X H7 X D2 W0.394 X H0.276 X D0.079	■ 1 to 50 0.039 to 1.969 ■ 1.5 to 34 0.059 to 1.339 ■ 2 to 24 0.079 to 0.945 ■ 3 to 17 0.098 to 0.906	■ 3 to 10 0.118 to 0.394 Cannot use Cannot use	ϕ 0.16 mm ϕ 0.006 in copper wire	 1 m 3.281 ft	FD-WZ4 NEW	
		Fiber bending type  W2 X H10 X D10 W0.079 X H0.394 X D0.394	■ 1 to 70 0.039 to 2.756 ■ 1 to 46 0.039 to 1.811 ■ 1 to 32.2 0.039 to 1.268 ■ 2.5 to 23 0.098 to 0.906	■ 2.5 to 15 0.098 to 0.591 ■ 3 to 7 0.118 to 0.276 ■ 3 to 7 0.118 to 0.276			FD-WZ4HB NEW	
	Small	Front sensing  W14 X H7 X D3.5 W0.551 X H0.276 X D0.138	■ 200 7.874 ■ 120 4.724 ■ 1 to 84 0.039 to 3.307 ■ 1 to 60 0.039 to 2.362	■ 1.5 to 35 0.059 to 1.378 ■ 2.5 to 18 0.098 to 0.709 ■ 2.5 to 18 0.098 to 0.709	ϕ 0.03 mm ϕ 0.0012 in gold wire	 2 m 6.562 ft	R1 mm R0.039 in	FD-WZ7 NEW
		Fiber bending type  W3.5 X H14 X D11 W0.138 X H0.551 X D0.433	■ 0.5 to 270 0.002 to 10.630 ■ 0.5 to 180 0.002 to 7.087 ■ 1 to 126 0.039 to 4.961 ■ 1 to 90 0.039 to 3.543	■ 1 to 70 0.039 to 2.756 ■ 1 to 35 0.039 to 1.378 ■ 1 to 35 0.039 to 1.378				FD-WZ7HB NEW
Long sensing range	Long sensing range - Rectangular head  W5.2 X H9.5 X D15 W0.205 X H0.374 X D0.591	■ 20 to 660 0.787 to 25.984 ■ 20 to 480 0.787 to 18.898 ■ 20 to 300 0.787 to 11.811 ■ 20 to 230 0.787 to 9.055	■ 20 to 170 0.787 to 6.693 ■ 25 to 90 0.984 to 3.543 ■ 25 to 100 0.984 to 3.937	ϕ 0.3 mm ϕ 0.012 in copper wire	 2 m 6.562 ft	R1 mm R0.039 in	FD-WKZ1	
Wide beam	Wide beam  W7 X H15 X D30 W0.276 X H0.591 X D1.181	■ 230 9.055 ■ 200 7.874 ■ 150 5.906 ■ 150 5.906	■ 100 3.937 ■ 45 1.772 ■ 50 1.969	ϕ 0.02 mm ϕ 0.0008 in gold wire	 2 m 6.562 ft	R25 mm R0.984 in	FD-A15	
Special	Array	Top sensing  W5 X H20 X D20 W0.197 X H0.787 X D0.787	■ 290 11.417 ■ 220 8.661 ■ 135 5.315 ■ 110 4.331	■ 78 3.071 ■ 35 1.378 ■ 39 1.535	ϕ 0.02 mm ϕ 0.0008 in gold wire	 2 m 6.562 ft	FD-AFM2	
		Side sensing  W5 X H20 X D20 W0.197 X H0.787 X D0.787	FD-AFM2E					
Liquid level sensing	Contact type  ϕ 6 ϕ 0.236				 2 m 6.562 ft (Note 5)	Protective tube R40 mm R1.575 in Fiber R15 mm R0.591 in	FD-F8Y	
	Mountable on pipe - Standard  W25 X H13 X D20 W0.984 X H0.512 X D0.787	Applicable pipe diameter: Outer dia. ϕ 6 to ϕ 26 mm ϕ 0.236 to ϕ 1.024 in transparent pipe [PVC (vinyl chloride), fluorine resin, polycarbonate, acrylic, glass, wall thickness 1 to 3 mm 0.039 to 0.118 in]		(Liquid)		FD-F41		
	Mountable on pipe - For PFA, wall thickness 1 mm 0.039 in pipe  W25 X H13 X D20 W0.984 X H0.512 X D0.787	Applicable pipe diameter: Outer dia. ϕ 6 to ϕ 26 mm ϕ 0.236 to ϕ 1.024 in transparent pipe [PFA (fluorine resin) or equivalently transparent pipe, wall thickness 1 mm 0.039 in]				FD-F4		

- Notes: 1) Refer to p.27 for the sensing ranges for the FX-301(-HS) in H-SP mode and for the FX-301B/G/H.
 2) The sensing range is specified for white non-glossy paper [200 X 200 mm 7.874 X 7.874 in (FD-WKZ1, FD-AFM2, FD-AFM2E): 400 X 400 mm 15.478 X 15.478 in] as the object.
 3) Please take care that the sensing range of the free-cut type fiber may be reduced by 20 % max. depending upon how the fiber is cut.
 4) The minimum sensing object size is the value for red LED type at maximum sensitivity. Note that the corresponding setting distance is different from the rated sensing distance.
 5) The allowable cutting range is 1,000 mm 39.370 in from the end that the amplifier inserted.

LIST OF FIBERS

FX-305 / FX-301 (Red LED type) sensing range (Note 1)

Reflective type



The FX-305 and FX-301(-HS) have different sensing modes.
 FX-305: H-SP, FAST, STD, STDF, LONG, U-LG (no S-D mode)
 FX-301(-HS): S-D, H-SP, FAST, STD, LONG (no STDF or U-LG mode)

Type	Shape of fiber head (mm in)	Sensing range (mm in)(Note 2, 3)	Min. sensing object (Note 4)	Fiber cable length (Free-cut)	Bending radius	Model No.		
Special	350 °C 662 °F · Coaxial M6			φ 0.02 mm φ 0.0008 in gold wire	2 m 6.562 ft	R25 mm R0.984 in		
	350 °C 662 °F · Sleeve 60 mm 2.362 in	300 11.811 270 10.630 150 5.906 140 5.512	100 3.937 35 1.378 47 1.850			Fiber R25 mm R0.984 in Sleeve R10 mm R0.394 in	FD-H35-M2S6	
	200 °C 392 °F · Coaxial M6					1 m 3.281 ft	R25 mm R0.984 in	
	350 °C 662 °F · Sleeve 90 mm 3.543 in	190 7.480 160 6.299 80 3.150 80 3.150	57 2.244 20 0.787 26 1.024				Fiber R25 mm R0.984 in Sleeve R10 mm R0.394 in	FD-H35-20S
	200 °C 392 °F · Coaxial M4	300 11.811 270 10.630 150 5.906 140 5.512	100 3.937 35 1.378 47 1.850					FD-H20-M1
	300 °C 572 °F · Glass substrate detection Convergent reflective type	0 to 20 0 to 0.787 0 to 15 0 to 0.591 0 to 10 0 to 0.394 0 to 10 0 to 0.394	Cannot use 12 to 6 0.079 to 0.236					FD-H20-21
	180 °C 356 °F · Glass substrate detection Convergent reflective type	0 to 20 0 to 0.787 0 to 15 0 to 0.591 0 to 10 0 to 0.394 0 to 10 0 to 0.394	1 to 8 0.039 to 0.315 Cannot use 12 to 6 0.079 to 0.236				FD-H30-L32	
	130 °C 266 °F M6	410 16.142 310 12.205 200 7.874 140 5.512	100 3.937 55 2.165 47 1.850				FD-H18-L31	
	Vacuum-resistant	300 °C 572 °F · Rectangular head W9.5 X H5.2 X D15 W0.374 X H0.205 X D0.591	20 to 300 0.787 to 11.811 20 to 200 0.787 to 7.874 20 to 150 0.787 to 5.906 25 to 130 0.984 to 5.118		Cannot use Cannot use 30 to 100 1.181 to 3.937	φ 0.8 mm φ 0.031 in gold wire	1 m 3.281 ft	R25 mm R0.984 in
		300 °C 572 °F · Glass substrate detection Convergent reflective type	0 to 11 0 to 0.433 0 to 8 0 to 0.315 1.5 to 6 0.059 to 0.236 1.5 to 5 0.059 to 0.197		Cannot use Cannot use Cannot use			2 m 6.562 ft
							2 m 6.562 ft	R18 mm R0.709 in
							3 m 9.843 ft	

- Notes: 1) Refer to p.27 for the sensing ranges for the FX-301-HS in H-SP mode and for the FX-301B/G/H.
 2) The sensing range is specified for white non-glossy paper [400 × 400 mm 15.748 × 15.748 in (FD-H30-L32, FD-H18-L31: 50 × 50 mm 1.969 × 1.969 in glass substrate, FD-H30-KZ1V-S, FD-H30-L32V-S: 100 × 100 × t 0.7 mm 3.937 × 3.937 × t 0.028 in transparent glass)] as the object.
 3) Please take care that the sensing range of the free-cut type fiber may be reduced by 20 % max. depending upon how the fiber is cut.
 4) The minimum sensing object size is the value for red LED type at maximum sensitivity. Note that the corresponding setting distance is different from the rated sensing distance.
 5) Sold as a set comprising vacuum type fiber + photo-terminal (FV-BR1) + fiber at atmospheric side (FT-J8). Please refer to 'Vacuum resistant fiber catalog' for details.

Model No. when ordering vacuum-resistant fibers individually as replacement parts

- Vacuum-resistant fiber
FD-H30-KZ1V
FD-H30-L32V
- Mounting bracket for FD-H30-KZ1V
MS-FD-2
- Photo-terminal
FV-BR1 (one pair set)
- Fiber at atmospheric side
FT-J8 (one pair set)

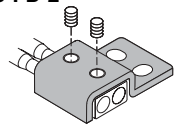

Accessories (attached with fibers)

- RF-003 (FR-KZ21/KZ21E exclusive mirror)
- RF-13 (Reflective tape)
- FX-CT1 (Fiber cutter)
- FX-CT2 (Fiber cutter)
- FX-AT2 (Attachment for fixed-length fiber, Orange)
- FX-AT3 (Attachment for φ 2.2 mm φ 0.087 in fiber, Clear orange)
- FX-AT4 (Attachment for φ 1 mm φ 0.039 in fiber, Black)
- FX-AT5 (Attachment for φ 1.3 mm φ 0.051 in fiber, Gray)
- FX-AT6 (Attachment for φ 1 mm φ 0.039 in / φ 1.3 mm φ 0.051 in mixed fiber, Black / Gray)

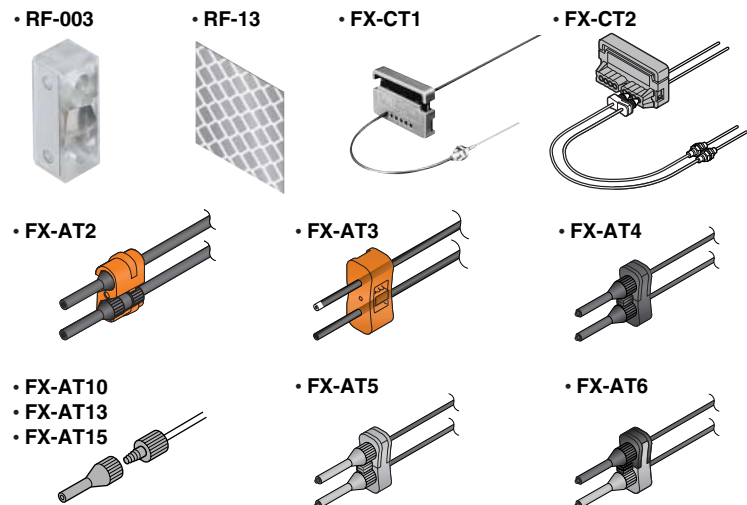

If connecting to a fiber amplifier other than the FX-300 series

- Applicable fiber amplifiers: FX2 / FX3 series
 FX-AT10 (Attachment for φ 1 mm φ 0.039 in fiber)
 FX-AT13 (Attachment for φ 1.3 mm φ 0.051 in fiber)
 FX-AT15 (Attachment for φ 1 mm φ 0.039 in / φ 1.3 mm φ 0.051 in mixed fiber)

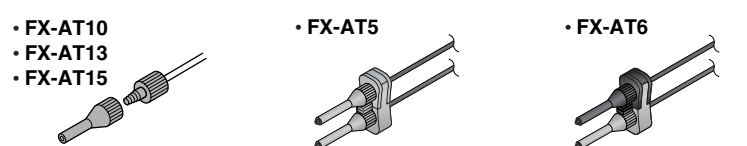

LIST OF SENSING RANGE FOR FX-301(P)-HS · FX-301B/G/H

Sensing range for ultra high-speed type FX-301(P)-HS in H-SP mode (35 μs)(Typical model)

	Fiber model No.	Sensing range (mm in) (Note)		Fiber model No.	Sensing range (mm in) (Note)
Thru-beam type	FT-B8	160 6.299	Reflective type	FD-B8	60 2.362
	FT-FM2	120 4.724		FD-FM2	35 1.378
	FT-NFM2	40 1.575		FD-NFM2	14 0.551
	FT-E12	2 0.079		FD-E12	1 0.039
	FT-E22	10 0.394		FD-E22	5 0.197

Note: The sensing ranges are in H-SP mode. The sensing ranges in FAST, STD, S-D and LONG modes are the same as for the **FX-301**. (Refer to p.18~)

Sensing range for FX-301B/G/H (Typical model)

(mm in)

		Thru-beam type										
		FT-B8	FT-FM2	FT-NFM2	FT-V10	FT-W8	FT-Z8	FT-P80	FT-A30	FT-A8	FT-E12	FT-E22
FX-301B	LONG	220 8.661	150 5.906	50 1.969	400 15.748	90 3.543	120 4.724	130 5.118	2,400 94.488	600 23.622	3 0.118	14 0.551
	STD	110 4.331	75 2.953	25 0.984	200 7.874	45 1.772	60 2.362	65 2.559	1,200 47.244	300 11.811	2 0.079	7 0.276
	FAST	75 2.953	40 1.575	16 0.630	130 5.118	30 1.181	40 1.575	45 1.772	700 27.559	220 8.661	1 0.039	4 0.157
FX-301G	LONG	110 4.331	70 2.756	24 0.945	200 7.874	56 2.205	60 2.362	70 2.756	1,200 47.244	300 11.811	1 0.039	6 0.236
	STD	55 2.165	35 1.378	12 0.472	100 3.937	28 1.102	30 1.181	35 1.378	600 23.622	150 5.906	—	3 0.118
	FAST	40 1.575	24 0.945	8 0.315	65 2.559	20 0.787	22 0.866	25 0.984	350 13.780	110 4.331	—	2 0.079
FX-301H (Note)	LONG	100 3.937	50 1.969	16 0.630	150 5.906	42 1.654	46 1.811	56 2.205	800 31.496	220 8.661	4 0.157	10 0.394
	STD	50 1.969	25 0.984	8 0.315	75 2.953	21 0.827	23 0.906	28 1.102	400 15.748	110 4.331	2 0.079	5 0.197
	FAST	30 1.181	18 0.709	5 0.197	40 1.575	15 0.591	16 0.630	20 0.787	240 9.449	80 3.150	1.5 0.059	3 0.118

Note: Infrared types are easily affected by humidity, so if using them in environments with high humidity or where the humidity fluctuates, please contact our office.

(mm in)

		Reflective type										
		FD-B8	FD-FM2	FD-NFM2	FD-W8	FD-P80	FD-AFM2	FD-G4	FD-EG1	FD-E12	FD-E22	FD-G6X
FX-301B	LONG	80 3.150	46 1.811	16 0.630	23 0.906	40 1.575	40 1.575	22 0.866	6 0.236	2 0.079	6 0.236	22 0.866
	STD	40 1.575	23 0.906	8 0.315	11 0.433	20 0.787	20 0.787	11 0.433	3 0.118	1 0.039	3 0.118	11 0.433
	FAST	26 1.024	15 0.591	5 0.197	8 0.315	13 0.512	13 0.512	8 0.315	2 0.079	—	2 0.079	6 0.236
FX-301G	LONG	42 1.654	24 0.945	8 0.315	14 0.551	20 0.787	18 0.709	12 0.472	3 0.118	1 0.039	3 0.118	12 0.472
	STD	21 0.827	12 0.472	4 0.157	7 0.276	10 0.394	9 0.354	6 0.236	1.5 0.059	—	1.5 0.059	6 0.236
	FAST	14 0.551	8 0.315	2 0.079	4 0.157	7 0.276	5 0.197	4 0.157	1 0.039	—	1 0.039	4 0.157
FX-301H (Note)	LONG	26 1.024	20 0.787	6 0.236	11 0.433	18 0.709	12 0.472	7 0.276	10 0.394	1 0.039	6 0.236	18 0.709
	STD	13 0.512	10 0.394	3 0.118	5.5 0.217	9 0.354	6 0.236	3.5 0.138	5 0.197	—	3 0.118	9 0.354
	FAST	9 0.354	7 0.276	2 0.079	3 0.118	6 0.236	4 0.157	2 0.079	3 0.118	—	2 0.079	5 0.197

Note: Infrared types are easily affected by humidity, so if using them in environments with high humidity or where the humidity fluctuates, please contact our office.

Sensing range when using in combination with FR-WKZ11 reflector (optional)

The sensing ranges are the values for **FX-305** / **FX-301** infrared types.

(mm in)

RF-230	100 to 3,200 3.937 to 125.984 (LONG), 100 to 2,000 3.937 to 78.740 (STD), 100 to 1,600 3.937 to 62.992 (FAST), 100 to 1,000 3.937 to 39.370 (S-D)
RF-220	100 to 2,400 3.937 to 94.488 (LONG), 100 to 1,300 3.937 to 51.181 (STD), 100 to 1,000 3.937 to 39.370 (FAST), 100 to 600 3.937 to 23.622 (S-D)
RF-210	100 to 1,100 3.937 to 43.307 (LONG), 100 to 700 3.937 to 27.559 (STD), 100 to 550 3.937 to 21.654 (FAST), 100 to 300 3.937 to 11.811 (S-D)

Note: The sensing range indicates the allowable setting range for the reflector. The fiber head can detect objects at distances of 100 mm 3.937 in or less.

However, note that if there are any white or highly-reflective surfaces near the fiber head, reflected incident light may affect the fiber head. If this occurs, adjust the threshold value of the amplifier before use.

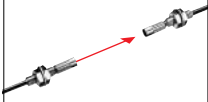

FIBER OPTIONS

Lens (For thru-beam type fiber)

Designation	Model No.	Description								
For thru-beam type fiber	Expansion lens (Note 1) FX-LE1		Increases the sensing range by 5 times or more. • Ambient temperature: - 60 to + 350 °C - 76 to + 662 °F							
		Sensing range for red LED type (mm) [Lens on both sides] (Note 3)	Fiber Mode	U-LG	LONG	STDF	STD	FAST	S-D	H-SP
			FT-B8	3,500	3,500	3,000	2,500	2,000	1,000	1,000
			FT-FM2	3,500	3,500	3,500	3,500	2,500	1,300	1,000
Super-expansion lens (Note 1) FX-LE2	Tremendously increases the sensing range with large diameter lenses. • Ambient temperature: - 60 to + 350 °C - 76 to + 662 °F	Sensing range for red LED type (mm) [Lens on both sides] (Note 3)	Fiber Mode	U-LG	LONG	STDF	STD	FAST	S-D	H-SP
			FT-B8	3,500	3,500	3,500	3,500	3,500	3,500	3,500
			FT-FM2	3,500	3,500	3,500	3,500	3,500	3,500	3,500
Side-view lens FX-SV1	Beam axis is bent by 90 °. • Ambient temperature: - 60 to + 300 °C - 76 to + 572 °F	Sensing range for red LED type (mm) [Lens on both sides] (Note 3)	Fiber Mode	LONG	STD	FAST	S-D			
			FT-B8	1,100	530	400	186			
			FT-FM2	1,200	600	440	210			
Expansion lens for vacuum fiber (Note 1) FV-LE1	Sensing range increases by 10 times or more. • Ambient temperature: - 40 to + 120 °C - 40 to + 248 °F	Sensing range for red LED type (mm) [Lens on both sides] (Note 3, 4)	Fiber Mode	U-LG	LONG	STDF	STD	FAST	S-D	H-SP
			FT-H30-M1V	1,600	1,200	650	450	300	150	200

Notes: 1) Be careful when installing the thru-beam type fiber equipped with the expansion lens, as the beam envelope becomes narrow and alignment is difficult. Especially when installing a fiber with many cores (sharp bending fibers and heat-resistant glass fiber), please be sure to use it only after you have adjusted it sufficiently.
2) The fiber cable length practically limits the sensing range to 3,500 mm 137.795 in long (FT-H20W-M1, FT-P81X and FT-H20-M1: 1,600 mm 62.992 in).
3) The sensing ranges are the values for red LED type amplifier. Please contact our office for details on sensing ranges for other types of amplifiers.
4) The fiber cable length for the FT-H30-M1V is 1 m 3.281 ft. The sensing ranges in U-LG and LONG modes take into account the length of the FT-J8 atmospheric side fiber.

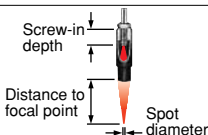
Lens (For reflective type fiber)

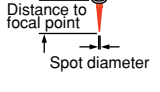
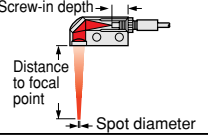
Designation	Model No.	Description	
For reflective type fiber	Pinpoint spot lens FX-MR1		Pinpoint spot of $\phi 0.5$ mm $\phi 0.020$ in. Enables detection of minute objects or small marks. • Distance to focal point: 6 ± 1 mm 0.236 ± 0.039 in • Applicable fibers: FD-WG4, FD-G4 • Ambient temperature: - 40 to + 70 °C - 40 to + 158 °F
	Zoom lens FX-MR2		The spot diameter is adjustable from $\phi 0.7$ mm to $\phi 2$ mm $\phi 0.028$ in to $\phi 0.079$ in according to how much the fiber is screwed in. • Applicable fibers: FD-WG4, FD-G4 • Ambient temperature: - 40 to + 70 °C - 40 to + 158 °F • Accessory: MS-EX-3 (mounting bracket)
	Finest spot lens FX-MR3		Extremely fine spot of $\phi 0.3$ mm $\phi 0.012$ in approx. achieved. • Applicable fibers: FD-WG4, FD-G4, FD-EG1, FD-EG2, FD-EG3, FD-G6X, FD-G6 • Ambient temperature: - 40 to + 70 °C - 40 to + 158 °F
	Finest spot lens FX-MR6		Extremely fine spot of $\phi 0.1$ mm $\phi 0.004$ in approx. achieved. • Applicable fibers: FD-WG4, FD-G4, FD-EG1, FD-EG2, FD-EG3, FD-G6X, FD-G6 • Ambient temperature: - 20 to + 60 °C - 4 to + 140 °F
	Zoom lens (Side-view type) FX-MR5		FX-MR2 is converted into a side-view type and can be mounted in a very small space. • Applicable fibers: FD-WG4, FD-G4 • Ambient temperature: - 40 to + 70 °C - 40 to + 158 °F

Note: The sensing ranges are the values when used in combination with red LED type amplifier. Please contact our office for details on sensing ranges for other types of amplifier.

FIBER OPTIONS

Others

Designation	Model No.	Description			
Protective tube (For thru-beam) type fiber	FTP-500 (0.5 m 1.640 ft)	For M4 thread	FT-B8 FT-P80 FT-FM2 FT-P60 FT-FM2S FT-FM2S4 FT-H13-FM2		
	FTP-1000 (1 m 3.281 ft)		Applicable fibers		
	FTP-1500 (1.5 m 4.921 ft)			The protective tube, made of non-corrosive stainless steel, protects the inner fiber cable from any external forces.	
	FTP-N500 (0.5 m 1.640 ft)	FT-T80 FT-P40 FT-NFM2 FD-T40 FT-NFM2S FD-P40 FT-NFM2S4			
	FTP-N1000 (1 m 3.281 ft)	For M3 thread			
	FTP-N1500 (1.5 m 4.921 ft)				
Protective tube (For reflective) type fiber	FDP-500 (0.5 m 1.640 ft)	For M6 thread	FD-B8 FD-P80 FD-FM2 FT-H13-FM2 FD-FM2S FD-FM2S4		
	FDP-1000 (1 m 3.281 ft)		Applicable fibers	The protective tube, made of non-corrosive stainless steel, protects the inner fiber cable from any external forces.	
	FDP-1500 (1.5 m 4.921 ft)				For M4 thread
	FDP-N500 (0.5 m 1.640 ft)	FD-T80 FD-NFM2 FD-NFM2S FD-NFM2S4			
	FDP-N1000 (1 m 3.281 ft)				
	FDP-N1500 (1.5 m 4.921 ft)				
Fiber bender	FB-1	The fiber bender bends the sleeve part of the fiber head at the proper radius. (Note)			
Universal sensor mounting stand	MS-AJ1-F	Horizontal mounting type	Mounting stand assembly for fiber (For M3, M4 or M6 threaded head fiber)		
	MS-AJ2-F	Vertical mounting type			
Fiber cutter	FX-CT2	The free-cut type fiber can be easily cut.			
	FX-CT1	Accessory. FX-CT1 is attached with the FT-P80 or the FD-P80. The FX-CT2 is provided with fibers other than this.			
Attachment for fixed-length fiber	FX-AT2	This is the attachment for the fixed length fiber. (Accessory)			
Attachment for $\phi 2.2$ mm $\phi 0.087$ in fiber	FX-AT3	This is the attachment for the $\phi 2.2$ mm $\phi 0.087$ in fiber. (Accessory. Does not attach with the FT-P80 or the FD-P80.)			
Attachment for $\phi 1$ mm $\phi 0.039$ in fiber	FX-AT4	This is the attachment for the $\phi 1$ mm $\phi 0.039$ in fiber. (Accessory)			
Attachment for $\phi 1.3$ mm $\phi 0.051$ in fiber	FX-AT5	This is the attachment for the $\phi 1.3$ mm $\phi 0.051$ in fiber. (Accessory)			
Attachment for $\phi 1$ mm $\phi 0.039$ in / $\phi 1.3$ mm $\phi 0.051$ in mixed fiber	FX-AT6	This is the attachment for the $\phi 1$ mm $\phi 0.039$ in / $\phi 1.3$ mm $\phi 0.051$ in mixed fiber. (Accessory)			

Note: Do not bend the sleeve part of any side-view type fiber or ultra-small diameter head type fiber.

Fiber attachment

It's possible to simultaneously cut two fibers to the same length

Each fiber (with some exceptions) has a newly developed two-in-one fiber attachment (FX-AT3/AT4/AT5/AT6) which enables two fibers to be cut simultaneously to the same length with the new fiber cutter (FX-CT2). Also, since the fibers can be attached to the amplifier while being fixed in position in the two-in-one fiber attachment, sensitivity changes resulting from variation in the amount of fiber insertion do not occur.

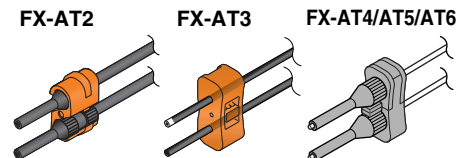
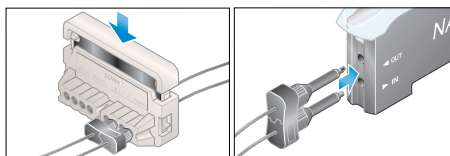

Protective tube

- FTP-□
- FDP-□

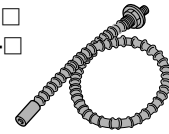

Fiber bender

- FB-1

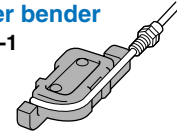

Fiber cutter

- FX-CT2

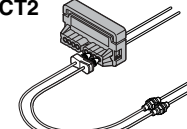

- FX-CT1

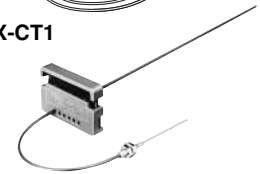

Universal sensor mounting stand

Using the arm which enables adjustment in the horizontal direction, sensing can also be done from above an assembly line.

- MS-AJ1-F

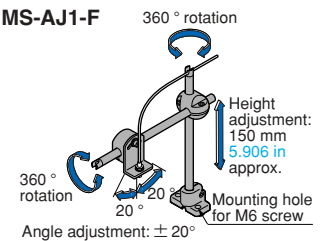

- MS-AJ2-F

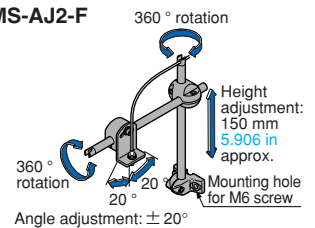

Guide to interchanging fiber length and sleeve length

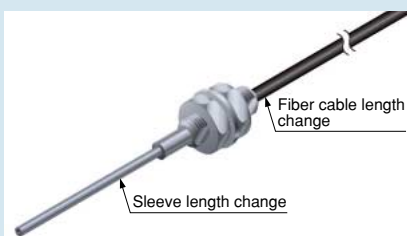

Custom-ordered products are available with different fiber lengths and sleeve lengths in order to respond quickly to different requirements.

Custom-ordered product (Typical)

- Fiber length can be set up to 30 m 98.425 ft in units of 1 m 3.281 ft FT-B8, FT-AFM2 etc.
- Sleeve length can be set up to 12 cm 4.724 in units of 1 cm 0.394 in FT-FM2S4, FD-NFM2S4 etc.

Please contact us.

SPECIFICATIONS

Refer to the 'Sensor general catalog 2003-2004' for fiber specifications.

Item	Model No.	Type	Standard type				High-speed type	High-function type
			Red LED	Blue LED	Green LED	Infrared LED		
			NPN output	FX-301	FX-301B	FX-301G	FX-301H	FX-301-HS
PNP output	FX-301P	FX-301BP	FX-301GP	FX-301HP	FX-301P-HS	FX-305P		
Supply voltage	12 to 24 V DC \pm 10 %						Ripple P-P 10 % or less	
Power consumption	<Red LED / Infrared LED type> Normal operation: 960 mW or less (Current consumption 40 mA or less at 24 V supply voltage) ECO mode: 600 mW or less (Current consumption 25 mA or less at 24 V supply voltage)				<Blue LED / Green LED type> Normal operation: 720 mW or less (Current consumption 30 mA or less at 24 V supply voltage) ECO mode: 430 mW or less (Current consumption 18 mA or less at 24 V supply voltage)			
Output	<NPN output type> NPN open-collector transistor • Maximum sink current: 100 mA (50 mA, if five, or more, amplifiers are connected in cascade.) • Applied voltage: 30 V DC or less (between output and 0 V) • Residual voltage: 1.5 V or less [at 100 mA (at 50 mA, if five, or more, amplifiers are connected in cascade) sink current.]				<NPN output type> NPN open-collector transistor 2 outputs • Maximum sink current: 50 mA each (Note 1) • Applied voltage: 30 V DC or less (between output and 0 V) • Residual voltage: 1.5 V or less [at 50 mA (Note 1)]			
	<PNP output type> PNP open-collector transistor • Maximum source current: 100 mA (50 mA, if five, or more, amplifiers are connected in cascade.) • Applied voltage: 30 V DC or less (between output and + V) • Residual voltage: 1.5 V or less [at 100 mA (at 50 mA, if five, or more, amplifiers are connected in cascade) source current.]				<PNP output type> PNP open-collector transistor 2 outputs • Maximum source current: 50 mA each (Note 1) • Applied voltage: 30 V DC or less (between output and + V) • Residual voltage: 1.5 V or less [at 50 mA (Note 1)]			
	Output operation	Selectable either Light-ON or Dark-ON, with jog switch						
Short-circuit protection	Incorporated							
Response time	65 μ s or less [H-SP (Red LED type only)], 150 μ s or less (FAST), 250 μ s or less [STD / S-D (Red LED type only)], 2 ms or less (LONG), selectable with jog switch				35 μ s or less (H-SP), 150 μ s or less (FAST), 250 μ s or less (STD / S-D), 2 ms or less (LONG), selectable with jog switch		65 μ s or less (H-SP), 150 μ s or less (FAST), 250 μ s or less (STD), 700 μ s or less (STDF), 2.5 ms or less (LONG), 4.5 ms or less (U-LG), selectable with jog switch	
Sensitivity setting	2-level teaching / Limit teaching / Manual adjustment / Full-auto teaching / Max. sensitivity teaching				Normal mode: 2-level teaching / Limit teaching / Full-auto teaching / Max. sensitivity teaching / Manual adjustment Window comparator mode: Teaching (1-level / 2-level / 3-level) / Manual adjustment			
Operation indicator	Orange LED (lights up when the output is ON)							
Stability indicator	Green LED (lights up under stable light received condition or stable dark condition)							
MODE indicator	RUN: Green LED, TEACH · ADJ · L/D ON · TIMER · PRO: Yellow LED							
Digital display	4 digit red LED display							
Fine sensitivity adjustment function	Incorporated							
Timer function	Incorporated with variable ON-delay / OFF-delay / ONE-SHOT timer, switchable either effective or ineffective. [Timer period: Red LED type; 0.5 ms approx., 1 ms to 9999 ms] [Blue LED, Green LED, Infrared LED type; approx. 0.5 ms to 500 ms]				Incorporated with variable ON-delay / OFF-delay / ONE-SHOT / ON-delay · OFF-delay / ON-delay · ONE-SHOT timer, switchable either effective or ineffective. (Timer period: Output 1; 0.5 ms, 1 ms to 9999 ms, Output 2; 0.5 ms, 1 ms to 500 ms)			
Light emitting amount selection function	Incorporated (Red LED type only)(Note 2) FAST, STD, LONG: 4 level, H-SP: 3 level, S-D: 2 level				Incorporated (Note 2) FAST, STD, LONG: 4 level H-SP, S-D: 2 level		Incorporated (Note 2) FAST, STD, STDF, LONG, U-LG: 4 level H-SP: 3 level	
Automatic interference prevention function	Incorporated (Up to four sets of fiber heads can be mounted close together. However, H-SP mode is 2 fiber heads.)(Note 3)				Incorporated (Note 2)		Incorporated [Up to four sets of fiber heads can be mounted close together. (However, U-LG mode is 8 fiber heads, H-SP mode is 2 fiber heads.)(Note 4)]	
Environmental resistance	Ambient temperature	- 10 to + 55 °C + 14 to + 131 °F (If 4 to 7 units are connected in cascade: - 10 to + 50 °C + 14 to + 122 °F, if 8 to 16 units are connected in cascade: - 10 to + 45 °C + 14 to + 113 °F (No dew condensation or icing allowed), Storage: - 20 to + 70 °C - 4 to + 158 °F						
	Ambient humidity	35 to 85 % RH, Storage: 35 to 85 % RH						
	Ambient illuminance	Sunlight: 10,000 ℓ x at the light-receiving face, Incandescent light: 3,000 ℓ x at the light-receiving face						
	Voltage withstandability	1,000 V AC for one min. between all supply terminals connected together and enclosure (Note 5)						
	Insulation resistance	20 M Ω , or more, with 250 V DC megger between all supply terminals connected together and enclosure (Note 5)						
	Vibration resistance	10 to 150 Hz frequency, 0.75 mm 0.030 in amplitude in X, Y and Z directions for two hours each						
	Shock resistance	98 m/s ² acceleration (10 G approx.) in X, Y and Z directions for five times each						
Emitting element (modulated)	Red LED	Blue LED	Green LED	Infrared LED	Red LED	Red LED		
Material	Enclosure: Heat-resistant ABS, Case cover: Polycarbonate, MODE key: Acrylic, Jog switch: Heat-resistant ABS (FX-301B/G/H: Acrylic)							
Connecting method	Connector (Note 6)							
Cable extension	Extension up to total 100 m 328.084 ft (50 m 164.042 ft for 5 to 8 units, 20 m 65.617 ft for 9 to 16 units) is possible with 0.3 mm ² , or more, cable.							
Weight	Net weight: 20 g approx., Gross weight: 25 g approx.							

Notes: 1) 50 mA per output. 25 mA if five, or more, amplifiers are connected in cascade.

2) The light emitting amount can be zero (emission halt) in all modes.

3) When the power supply is switched on, the light emission timing is automatically set for interference prevention.

4) When the interference prevention function 'IP-2' is set, the number of mountable fiber heads becomes double. Furthermore, take care that the response time also becomes double.

5) The voltage withstandability and the insulation resistance values given in the above table are for the amplifier only.

6) The cable for amplifier connection is not supplied as an accessory. Make sure to use the optional quick-connection cables given below.

Main cable (3-core) for FX-301(P)(-HS): CN-73-C1 (Cable length 1 m 3.281 ft), CN-73-C2 (Cable length 2 m 6.562 ft), CN-73-C5 (Cable length 5 m 16.404 ft)

Sub cable (1-core) for FX-301(P)(-HS): CN-71-C1 (Cable length 1 m 3.281 ft), CN-71-C2 (Cable length 2 m 6.562 ft), CN-71-C5 (Cable length 5 m 16.404 ft)

Main cable (4-core) for FX-305(P): CN-74-C1 (Cable length 1 m 3.281 ft), CN-74-C2 (Cable length 2 m 6.562 ft), CN-74-C5 (Cable length 5 m 16.404 ft)

Sub cable (2-core) for FX-305(P): CN-72-C1 (Cable length 1 m 3.281 ft), CN-72-C2 (Cable length 2 m 6.562 ft), CN-72-C5 (Cable length 5 m 16.404 ft)

I/O CIRCUIT DIAGRAMS

FX-301(-HS) NPN output type

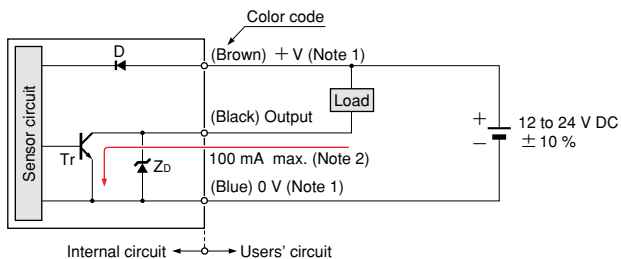

Notes: 1) The quick-connection sub cable does not have +V (brown) and 0 V (blue). The power is supplied from the connector of the main cable.
2) 50 mA max., if five amplifiers, or more, are connected together.

Symbols ... D : Reverse supply polarity protection diode
Zd: Surge absorption zener diode
Tr: NPN output transistor

FX-305 NPN output type

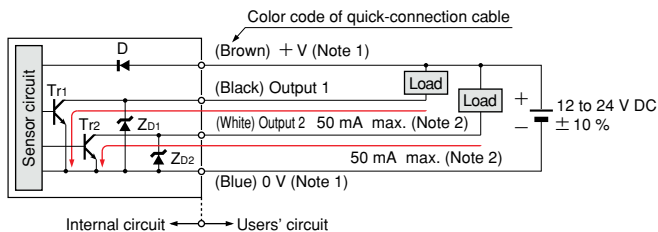

Notes: 1) The quick-connection sub cable does not have +V (brown) and 0 V (blue). The power is supplied from the connector of the main cable.
2) 25 mA max., if five amplifiers, or more, are connected together.

Symbols ... D: Reverse supply polarity protection diode
ZD1, ZD2: Surge absorption zener diode
Tr1, Tr2 : NPN output transistor

FX-301P(-HS) PNP output type

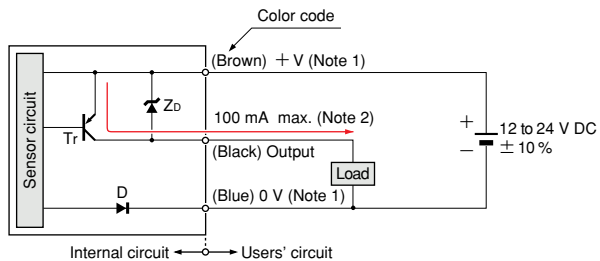

Notes: 1) The quick-connection sub cable does not have +V (brown) and 0 V (blue). The power is supplied from the connector of the main cable.
2) 50 mA max., if five amplifiers, or more, are connected together.

Symbols ... D : Reverse supply polarity protection diode
Zd: Surge absorption zener diode
Tr: PNP output transistor

FX-305P PNP output type

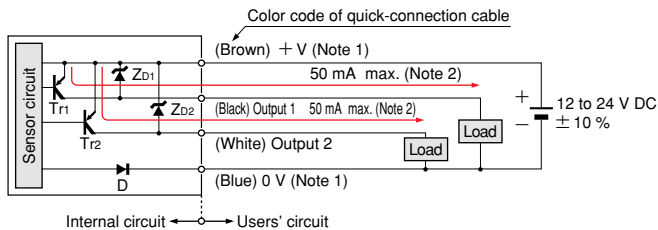

Notes: 1) The quick-connection sub cable does not have +V (brown) and 0 V (blue). The power is supplied from the connector of the main cable.
2) 25 mA max., if five amplifiers, or more, are connected together.

Symbols ... D: Reverse supply polarity protection diode
ZD1, ZD2: Surge absorption zener diode
Tr1, Tr2 : PNP output transistor

PRECAUTIONS FOR PROPER USE



This product is not a safety sensor. Its use is not intended or designed to protect life and prevent body injury or property damage from dangerous parts of machinery. It is a normal object detection sensor.

Part description

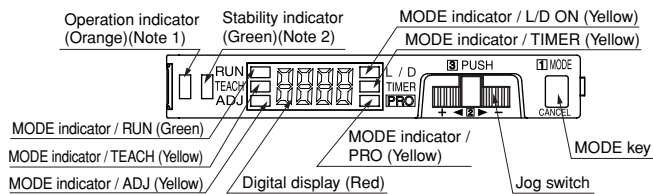

Notes: 1) FX-305(P); Output 1 operation indicator (Orange)
2) FX-305(P); Output 2 operation indicator (Orange)

Refer to the 'Sensor general catalog 2003-2004' for fiber precautions.

Operation procedure

- When the power supply is switched on, communication self-check is carried out and normal condition is displayed [MODE indicator / RUN (green) lights up and the digital display shows incident light intensity].
- When MODE key is pressed, the mode changes as per the diagram below.

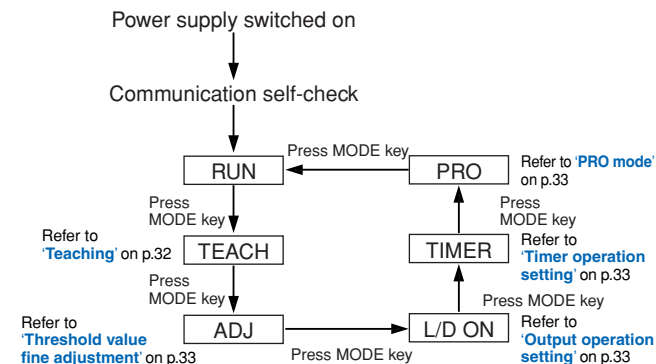

When jog switch is pressed, the setting is confirmed.
When MODE key is pressed for 2 sec., or more, the sensor returns to the RUN mode.
Cancellation is possible by pressing MODE key during setting.

For FX-305(P)

The FX-305 is equipped with two independent outputs, but the items that can be set in output 1 and output 2 respectively are only the following. The items other than those are common.
① Threshold value ② Output operation
③ Timer operation and Timer period ④ Sensing mode

PRECAUTIONS FOR PROPER USE









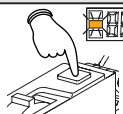

Refer to the 'Sensor general catalog 2003-2004' for fiber precautions.

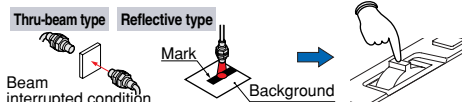
Teaching

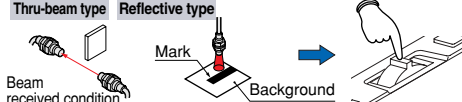
- The threshold values can be set by normal mode (2-level teaching, limit teaching or full-auto teaching) or window comparator mode (1-level / 2-level / 3-level teaching) [FX-305(P) only], when the MODE indicator / TEACH (yellow) lights up.

In case of 2-level teaching









- This is the method of setting the threshold value by teaching two levels, corresponding to the object present and object absent conditions. Normally, setting is done by this method.

Step	Description	Display
①	Set the fiber within the sensing range. Press the MODE key to light up MODE indicator / TEACH (yellow). 	
②	For the FX-305(P), select 'Out1' or 'Out2' beforehand. Press jog switch in the object present condition. If the teaching is accepted, the read incident light intensity blinks in the digital display. Thru-beam type Reflective type 	
③	MODE indicator / TEACH (yellow) blinks. Press the jog switch in the object absent condition. Thru-beam type Reflective type 	
④	If the teaching is accepted, the read incident light intensity blinks in the digital display and the threshold value is set at the mid-value between the incident light intensities in the object present and the object absent conditions. After this, the judgment on the stability of sensing is displayed. • In case stable sensing is possible: 'Good' is displayed. • In case stable sensing is not possible: 'Err d' blinks.	 
⑤	The threshold value is displayed.	
⑥	'....' blinks in the digital display. (FX-301B/G/H only)	
⑦	The incident light intensity in the digital display and the setting is complete.	

- Notes: 1) Do not move or bend the fiber cable after the sensitivity setting. Detection may become unstable.
2) In case of using the reflective type fibers, if Jog switch is pressed in the object absent condition at ② and ③, the sensitivity is set to the maximum.

In case of full-auto teaching









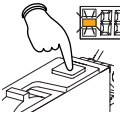

- Full-auto teaching is used when it is desired to set the threshold value without stopping the assembly line, with the object in the moving condition.

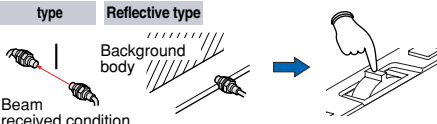
Step	Description	Display
①	Set the fiber within the sensing range. Press MODE key to light up MODE indicator / TEACH (yellow). 	
②	For the FX-305(P), select 'Out1' or 'Out2' beforehand. Press the jog switch continuously for 0.5 sec. or more with the object moving on the assembly line. (The incident light intensity is displayed during sampling.)	
③	'Auto' is displayed on the digital display. Release the jog switch when the object has passed.	
④	If the teaching is accepted, the read incident light intensity blinks in the digital display and the threshold value is set at the mid-value between the incident light intensities in the object present and the object absent conditions. After this, the judgment on the stability of sensing is displayed. • In case stable sensing is possible: 'Good' is displayed. • In case stable sensing is not possible: 'Err d' blinks.	 
⑤	The threshold value is displayed.	
⑥	'....' blinks in the digital display. (FX-301B/G/H only)	
⑦	The incident light intensity in the digital display and the setting is complete.	

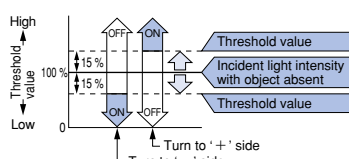
- Notes: 1) The threshold value's shift amount can be selected in PRO mode. (Increments of 5% between -45 and 45% for setting possible. 0% default.)
2) Do not move or bend the fiber cable after the sensitivity setting. Detection may become unstable.

In case of limit teaching

- This is the method of setting the threshold value by teaching only the object absent condition (stable incident light condition). This is used for detection in the presence of a background body or for detection of minute objects.





Step	Description	Display
①	Set the fiber within the sensing range. Press the MODE key to light up MODE indicator / TEACH (yellow). 	
②	For the FX-305(P), select 'Out1' or 'Out2' beforehand. Press the jog switch in the object absent condition. If the teaching is accepted, the read incident light intensity blinks in the digital display. type Reflective type 	
③	MODE indicator / TEACH (yellow) blinks. Turn jog switch to the '+' side or '-' side.	
④	If the jog switch is turned to the '+' side, ' ' scrolls (twice)(Note 2) the display from right to left, and the threshold level is shifted to a value approx. 15% higher (lower sensitivity) than that set at ②. (Note 1) This is used in case of reflective type fibers. If the jog switch is turned to the '-' side, ' ' scrolls (twice) (Note 2) the display from left to right, and the threshold level is shifted to a value approx. 15% lower (higher sensitivity) than that set at ②. (Note 1) This is used in case of thru-beam type fibers. 	
⑤	After this, the judgment on whether the setting shift amount can be shifted or not is displayed. • In case shifting is possible: 'Good' blinks. • In case shifting is not possible: 'Err d' blinks.	 
⑥	The threshold value is displayed.	
⑦	'....' blinks in the digital display. (FX-301B/G/H only)	
⑧	The incident light intensity appears in the digital display and the setting is complete.	

- Notes: 1) The FX-301B/G/H has no scroll display.
2) The approx. 15% amount of shift is the initial value. The amount of shift can be changed in the PRO mode from approx. 5 to 80% (5% step).
3) Do not move or bend the fiber cable after the sensitivity setting. Detection may become unstable.



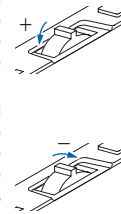

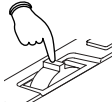

Please refer to the 'Sensor general catalog 2003-2004' or website (<http://www.sunx.jp>) for setting of threshold value when used in combination with contact type liquid level detection fiber FD-F8Y, and for setting of threshold value when used in combination with pipe-mountable liquid level detection fiber FD-F4□.

PRECAUTIONS FOR PROPER USE

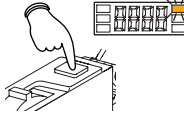
Threshold value fine adjustment

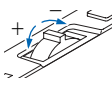
Step	Description	Display
①	Press the MODE key to light up MODE indicator / ADJ (yellow). 	—
②	For the FX-305(P) , select 'Out1' or 'Out2' beforehand. In case the threshold value is to be increased (sensitivity to be reduced), turn the jog switch to the '+' side to increase the threshold value slowly. If the jog switch is turned continuously to the '+' side, the threshold value increases rapidly. In case the threshold value is to be decreased (sensitivity to be increased), turn the jog switch to the '-' side to decrease the threshold value slowly. If the jog switch is turned continuously to the '-' side, the threshold value decreases rapidly. 	 ↓  or  ↓ 
③	When the jog switch is pressed, the threshold value is confirmed. 	—

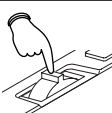
Output operation setting

Step	Description	Display
①	Press the MODE key to light up MODE indicator / L/D ON (yellow). 	 Displays present setting
②	For the FX-305(P) , select 'Out1' or 'Out2' beforehand. If the jog switch is turned to the '+' or '-' direction, the output operation setting will change. 	 ↓ Light state ↑  Dark state ↓
③	When the jog switch is pressed, the threshold value is confirmed. 	 Displays selected setting

Timer operation setting

- When the MODE indicator / TIMER (yellow) lights up, you can set the type of timer and whether the timer is to be used or not. For the **FX-301B/G/H**, the type of timer is set in PRO mode.
- Further, an OFF-delay which is useful when the response of the connected device is slow, etc., an ON-delay which is useful to detect only objects taking a long time to travel, and ONE-SHOT, which is useful when the input specifications of the connected device require a signal of a fixed width, are possible with the **FX-301□(-HS)**. [Furthermore, ON-delay • OFF-delay and ON-delay • ONE-SHOT timer are incorporated for **FX-305(P)**.]







Cascading amplifiers

- The **FX-301(P)**, **FX-301B/G/H(P)** and **FX-305(P)** cannot use communication for any settings other than the automatic interference prevention function. When using these amplifiers as well, use only the same type of amplifiers all together. However, the **FX-301-HS(P)** is not equipped with an optical communication function for setting the automatic interference prevention function, so be aware of this when using these amplifiers with other amplifiers.
- If the **FX-301(P)** updated version unit or the **FX-305(P)** is mounted with the **FX-301(P)** previous version unit or the **FX-301B/G/H(P)** in cascade, place the **FX-301(P)** updated version units and the **FX-305** units to the right side (seen from the connector side) of the previous version units. For a difference between the updated version unit and the previous version unit, refer to '**A difference between the updated version unit and the previous version unit**' (P.34).

PRO mode

- PRO settings can be done when MODE indicator / PRO (yellow) lights up.

PRO mode table

	Display	Description
PRO1		① Response time change function 'SPeD' ② Timer setting function 'dELy' ③ Hysteresis function 'HYSt' ④ Stability function 'StEb' ⑤ Shift function 'ShFt' ⑥ Emitting power selection function 'PcLl' (Note 1)
PRO2		① Digital display setting function 'dISp' ② Digital display inversion function 'Lvrn' ③ ECO mode setting function 'Eco'
PRO3		① Data bank load setting function 'cLdL' ② Data bank save setting function 'cHsR'
PRO4		① Setting condition copy function 'CoPY' ② Remote data bank load setting function 'cLdL' ③ Remote data bank save setting function 'cHsR' ④ Communication condition confirmation function 'tEST' (Note 2) ⑤ Communication lock function 'L-Lc' ⑥ Back-up function 'b-uP' (Note 3)
PRO5		① Code setting function 'Code' ② Adjust lock setting function 'R.Lc' ③ Setting reset function 'rSEt' ④ Interference prevention function 'InP' (Note 4)
PRO6 (Note 4)		① Output setting function 'Out1', 'Out2'

- Notes: 1) **FX-301(P)** updated version unit, **FX-301(P)-HS**, **FX-305(P)** only
2) **FX-301B(P)/G(P)/H(P)** only
3) **FX-301(P)** updated version unit, **FX-305(P)** only
4) **FX-305(P)** only

Key-lock function

- If the jog switch and the MODE key are pressed for more than 3 sec. at the same time in RUN mode condition, the key operations are locked, and only the threshold value confirmation function or the adjust function (valid only when the adjust lock function is canceled) is valid.

Wiring

- When the emission halt of the emitting power switching function is set from 'OFF' to 'ON', the output may be unstable. Do not use the output control for 0.5 sec. after starting emission.
- Make sure that the power supply is off while wiring.
- Verify that the supply voltage variation is within the rating.
- Take care that if a voltage exceeding the rated range is applied, or if an AC power supply is directly connected, the sensor may get burnt or damaged.
- If power is supplied from a commercial switching regulator, ensure that the frame ground (F.G.) terminal of the power supply is connected to an actual ground.
- In case noise generating equipment (switching regulator, inverter motor, etc.) is used in the vicinity of this product, connect the frame ground (F.G.) terminal of the equipment to an actual ground.
- Take care that short-circuit or wrong wiring of the load may burn or damage the sensor.
- Do not run the wires together with high-voltage lines or power lines or put them in the same raceway. This can cause malfunction due to induction.
- Ensure that an isolation transformer is utilized for the DC power supply. If an auto transformer is utilized, the main amplifier or power supply may be damaged.
- Make sure to use the optional quick-connection cable for the connection of the amplifier [**FX-301(P)-HS** / **FX-305(P)**]. Extension up to total 100 m **328.084 ft** (50 m **164.042 ft** for 5 to 8 units, 20 m **65.617 ft** for 9 to 16 units), is possible with 0.3 mm², or more, cable. However, in order to reduce noise, make the wiring as short as possible.

Others

- Do not use during the initial transient time (0.5 sec. approx.) after the power supply is switched on.
- Take care that the sensor is not directly exposed to fluorescent light from a rapid-starter lamp or a high frequency lighting device, as it may affect the sensing performance.
- This sensor is suitable for indoor use only.
- Avoid dust, dirt, and steam.
Take care that the product does not come in direct contact with water, oil, grease, or organic solvents, such as, thinner, etc.
- This sensor cannot be used in an environment containing inflammable or explosive gasses.
- Never disassemble or modify the sensor.

PRECAUTIONS FOR PROPER USE

Refer to the 'Sensor general catalog 2003-2004' for fiber precautions.

Function table for FX-300 series

	Previous models			New models		
	FX-301(P) (Previous version unit)	FX-302(P)	FX-303(P)	FX-301(P) (Updated version unit)	FX-301(P)-HS	FX-305(P)
Four-chemical emitting element + APC circuit	×	×	×	○	○	○
Four-chemical emitting element only	○ (Note 1)	○	○	—	—	—
Light emitting amount selection function	×	×	×	○	○	○
Reduced intensity mode (S-D)	○ (Note 1)	○	×	○	○	—
9,999 digit display	×	×	×	×	×	○
Response time (Max. speed)	150 μs	300 μs	90 μs	65 μs	35 μs	65 μs
Interference prevention function (Effective no. of units)	Incorporated (4)	Incorporated (8)	Not incorporated (0)	Incorporated (4)	Not incorporated (0)	Incorporated (16)
Independent 2 outputs	×	×	×	×	×	○
Alarm output function	×	×	×	×	×	○
Error output function	×	×	×	×	×	○
Differential sensing	×	×	×	×	×	○
Window comparator mode	×	○	×	×	×	○
Peripheral units that can be combined						
FX-CH(-P)	○	○	×	×	×	×
FX-CH2(-P)	×	×	×	○	×	○
SC-GU1-485	×	×	×	○	×	○

Note: Except FX-301B/G/H.

A difference between the updated version unit and the previous version unit for FX-301 (Red LED type)

Changes in appearance

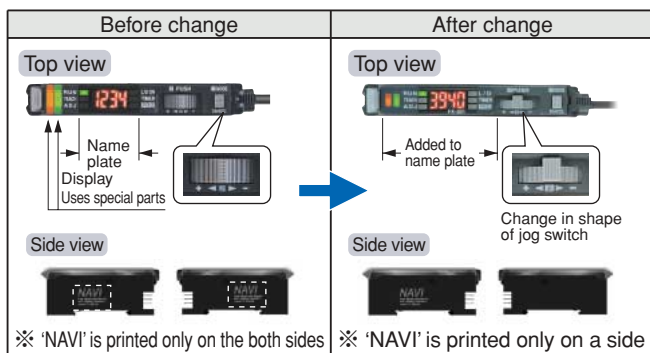

Checking minor changes between previous and new models can be done by checking whether the printing is on both sides or only one side.

Upgraded functions

1. Response times added

An ultra high-speed mode (H-SP) has been added to the existing 4 response time modes [high-speed (FAST), reduced intensity (S-D), standard (STD) and long range (LONG)]. This is changed using 'Pro1' in 'SPEd'.

Before change	After change
4 steps	5 steps
FAST 150 μs (FAST)	H-SP 65 μs (added)(H-SP)
S-d 250 μs (S-D)	FAST 150 μs (FAST)
Std 250 μs (STD)	S-d 250 μs (S-D)
Long 2 ms (LONG)	Std 250 μs (STD)
	Long 2 ms (LONG)

2. Extension of timer period

The setting range for the timer period was previously 500 ms, but this has been extended to a new range of 9999 ms.

3. Light emitting amount selection function

The light emitting amount can be changed to one of 4 levels (5 levels when emission halt is included).

4. Backup, copy lock and key lock functions added

Backup: This selects whether or not threshold values set by teaching are written to (stored in) an EEPROM.

Copy lock: This selects whether copy function and data bank function communication are possible or not.

Key lock: This disables input using switches to prevent accidental changing of settings.

Changes in operation

1. Timer selection method

Previous version unit: Timer type was changed using PRO1 mode. The 'TIMER' setting in NAVI mode could only be turned on or off.

After change: The type of timer can be changed using the 'TIMER' function in NAVI mode.

2. Checking threshold value in RUN mode

The threshold values can be checked by turning the jog switch.

Display changes

1. Checking blinking of sensitivity surplus

The stable surplus display method after teaching has been changed.

Previous version unit: Sensitivity surplus is indicated by the number of blinks of the stability indicator.



2. Initial direct code value changed

The factory default settings for the direct codes have been changed.

Previous version unit 0000 → After change 0004

※ The default setting for the timer period is 10 ms, and the direct code for 10 ms is '4', so this has been changed.

Internal circuit changes

1. Addition of an APC circuit

A four-chemical emitting element which provides stable sensing over long periods has been added, as well as an APC (Auto Power Control) circuit that improves stability during short periods.

Points to note when combining sensor types

When using the newer sensors together with previous version units (including the FX-301B/G/H), note the following.

- Communication is possible when the previous version units and the updated version units are used in an arrangement such as that shown in Figure A below.
- If the previous version units and the updated version units are used in an arrangement such as that shown in Figure B below, the interference prevention function and the PRO4 function cannot be used.
- In order to use the interference prevention function and the PRO4 function when using previous version units and the updated version units together, it is recommended that you use an arrangement such as that shown in Figure C below.

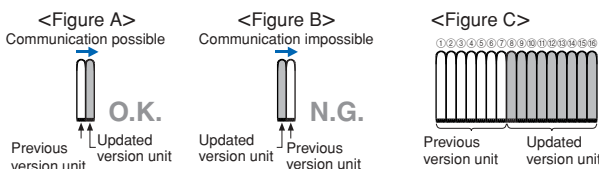

DIMENSIONS (Unit: mm in)

Refer to the 'Sensor general catalog 2003-2004' for fiber dimensions.
The CAD data in the dimensions can be downloaded from the website: <http://www.sunx.jp/>

FX-301 □
FX-305 □ Amplifier

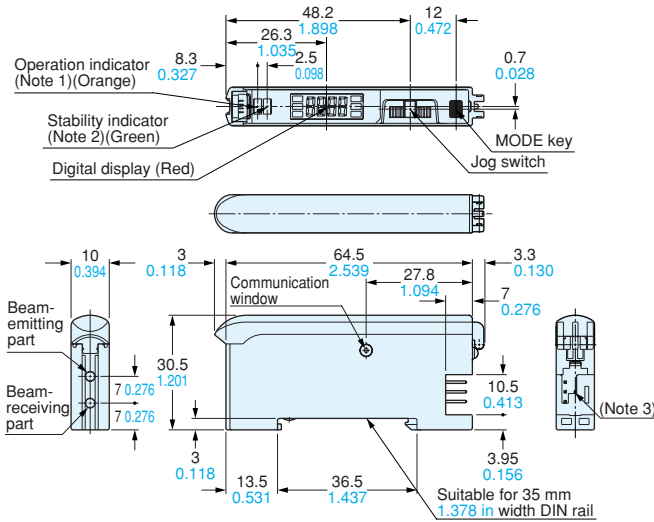

- Notes: 1) **FX-305** □; Output 1 operation indicator (Orange)
2) **FX-305** □; Output 2 operation indicator (Orange)
3) **FX-301** □; 3-pin, **FX-305** □; 4-pin

CN-73-C □
CN-74-C □ Main cable (Optional)

• Length (L)

Model No.	Length (mm in)
CN-73/74-C1	1,000 39.370
CN-73/74-C2	2,000 78.740
CN-73/74-C5	5,000 196.850

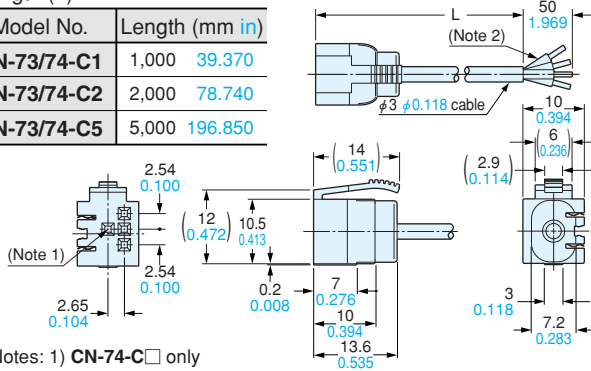

- Notes: 1) **CN-74-C** □ only
2) **CN-74-C** □; 4-core

CN-71-C □
CN-72-C □ Sub cable (Optional)

• Length (L)

Model No.	Length (mm in)
CN-71/72-C1	1,000 39.370
CN-71/72-C2	2,000 78.740
CN-71/72-C5	5,000 196.850

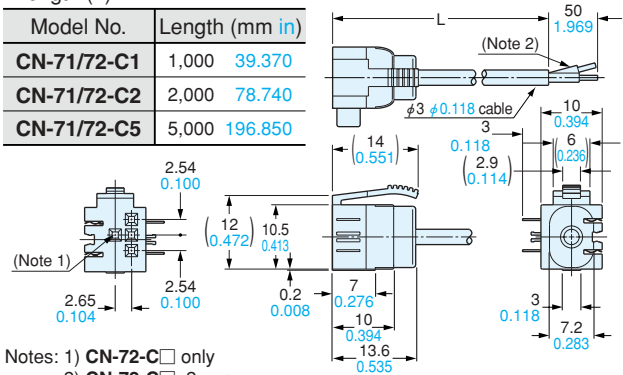

- Notes: 1) **CN-72-C** □ only
2) **CN-72-C** □; 2-core

Introducing digital laser sensor LS series

Making high precision laser sensing more intuitive and easier to use

- Minute objects can be sensed even at removed distances.
- 3 types of laser sensor head available.
- Side-by-side placement together with fiber sensors is also possible.

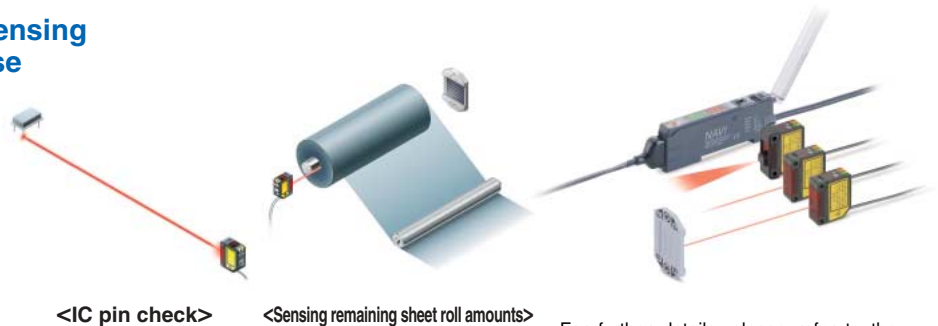

For further details, please refer to the SUNX home page (<http://www.sunx.co.jp/>) or contact our office.

External Input Unit for Digital Sensor / FX-CH2



Support for stable sensing and smooth setup changes!

Teaching and data bank switching for up to a maximum of 16 digital fiber sensors (FX-301 and FX-305) can be carried out all at once using an external device such as a PLC, touch screen or switch.



Applications involving smooth setup operations

Setup changes (external automatic teaching / data bank switching)

Digital fiber settings can be changed using input from a touch screen or switch, so that production line setup changes can be carried out more easily.

External teaching

Full-auto teaching is recommended for teaching when the sensing object is changed without stopping the line.

Data bank switching

Settings such as output operations (L-ON / D-ON) and timer operations can be recorded in the digital fiber sensor's data bank and switching can be carried out externally.

※ Up to 3 files can be stored.



FX-CH2 function list

Teaching input

The following types of external teaching can be carried out.

- Full-auto teaching
- Limit teaching '—'
- Limit teaching '+'
- 2-level teaching

Key lock setting input

The key lock function that prevents incorrect operations by operators can be set on and off.

Data bank switching input

Switching between 3 channels of data banks and loading and saving of all channels at once can be carried out.

Product lineup

Connector for input device
CN-EP1 [1 pc. included with FX-CH2(-P)]

Input signal

The types of input operations are determined by S1 and S2, and the input timing is determined by S3.

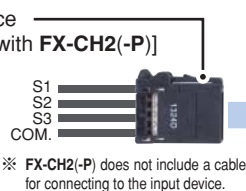

External input unit FX-CH2(-P)

Quick-connection cable
CN-73-C□ (Optional)

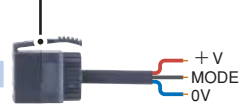

Mode selection

The MODE wire can be switched between high and low to select the input mode from either 'external teaching and key lock' or 'data bank switching'.

Explanation of limit teaching

Limit teaching '—'

Limit teaching '—' shifts the threshold value setting to make it less than the incident light intensity during teaching.

When limit teaching is not used

If the incident light intensity changes with respect to the initial threshold setting value because of reasons such as beam axis slippage, sensing can become unstable and incorrect operations can occur.

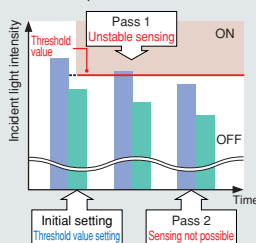

■ Incident light intensity when sensing object is not present
■ Incident light intensity when sensing object is present

When limit teaching '—' is used

The threshold value is reset each time before the sensing object arrives, (limit teaching '—'). As a result, sensing is not affected by changes in incident light intensity.

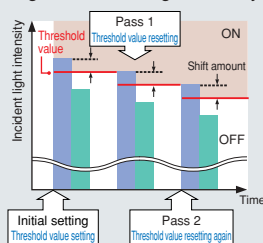

■ Incident light intensity when sensing object is not present
■ Incident light intensity when sensing object is present

Limit teaching '+'

Limit teaching '+' is the opposite of limit teaching '—', so that the threshold value setting is shifted toward a higher setting to make it more than the incident light intensity during teaching.

When limit teaching is not used

If dust or other particles cause changes in the incident light intensity with respect to the initial threshold setting value, sensing can become unstable and incorrect operations can occur.

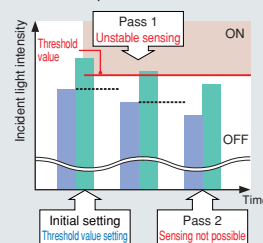

※ When limit teaching is used, use the SHIFT function in PRO mode of the amplifier to set the shift amount beforehand.

When limit teaching '+' is used

The threshold value is reset each time before the sensing object arrives, (limit teaching '+'). As a result, sensing is not affected by changes in incident light intensity.

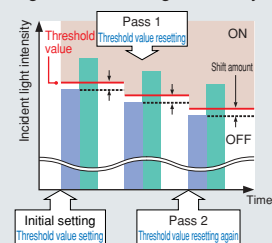

ORDER GUIDE

Designation		Model No.
External input unit	NPN input type	FX-CH2
	PNP input type	FX-CH2-P
Connector for input device (1 pc. included as standard with external input unit)		CN-EP1 5 pcs. per set
Quick-connection cable (Main cable)	Length: 1 m	CN-73-C1 3.281 ft
	Length: 2 m	CN-73-C2 6.562 ft
	Length: 5 m	CN-73-C5 16.404 ft
End plate		MS-DIN-E 2 pcs. per set

SPECIFICATIONS

Item	Type	NPN input type	PNP input type
	Model No.	FX-CH2	FX-CH2-P
Applicable sensor		FX-301(P) (Note 1), FX-305(P)	
Supply voltage		12 to 24 V DC $\pm 10\%$ Ripple P-P 10% or less	
Power consumption		600 mW or less (when all indicators light up)	
Input		Low: 0 to +2 V DC Source current 0.5 mA Input impedance 10 k Ω approx. High: +5 V to +V DC, or open	Low: +4 V to +V DC Sink current 0.5 to 3 mA Input impedance 10 k Ω approx. High: 0 to +0.6 V DC, or open
Power indicator		Green LED (Lights up when the power is ON)	
Transmission operation indicator		Green LED (Lights up when loaded, and 2-level / Limit teaching, blinks \rightarrow lights up when saved, and Full-auto teaching)	
Ambient temperature		-10 to +55 °C +14 to +131 °F (if 4 to 7 sensors are connected in cascade: -10 to +50 °C +14 to +122 °F, if 8 to 16 sensors are connected in cascade: -10 to +45 °C +14 to +113 °F)(No dew condensation or icing allowed), Storage: -20 to +70 °C -4 to +158 °F	
Material		Enclosure: Heat-resistant ABS	
Cable extension		Extension up to total 10 m 32.808 ft is possible with 0.3 mm ² , or more, cable.	
Weight		Net weight: 20 g approx., Gross weight: 40 g approx.	
Accessory		CN-EP1 (Connector for input device)(Note 2): 1 pc.	

Notes: 1) Only updated version of **FX-301(P)** can be used. Do not use the previous version of **FX-301(P)**.
The updated version of **FX-301(P)** have 'NAVI' printed on one side. (See the right figure.)

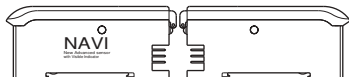

2) The applicable wire is 0.08 mm² (AWG 28) to 0.5 mm² (AWG 20) and the wire sheath diameter should be $\phi 1.5$ mm $\phi 0.059$ in or less.

I/O CIRCUIT DIAGRAMS

FX-CH2

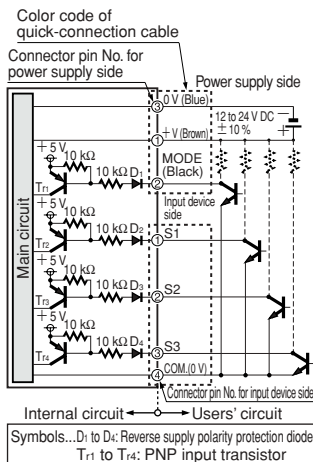

FX-CH2-P

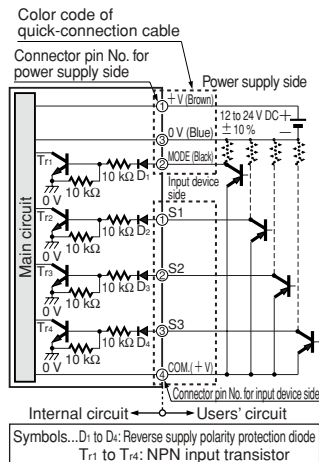

OPERATION TIMING CHART

When MODE is set to High (Low for FX-CH2-P) or open

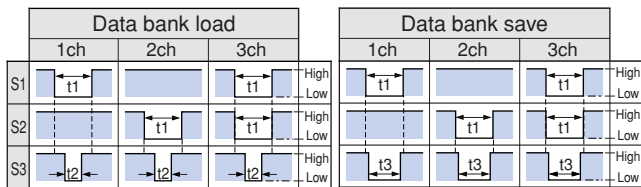

t1 : t1 > t2, t1 > t3 t2 : 20 ms to less than 2 sec. t3 : 2 sec. or more

When MODE is set to Low (High for FX-CH2-P)

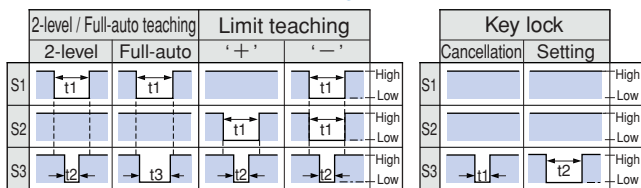

t1 : t1 > t2, t1 > t3
t2 : 20 ms to less than 2 sec. (This is the timing period for 1 level. 2 levels are required.)
t3 : 0.5 sec. or more (Sampling starts after 0.5 sec.)

Notes: 1) The above diagrams show the **FX-CH2** (NPN input type).

For the **FX-CH2-P** (PNP input type), High and Low are reversed.

2) After each operation has been confirmed, the fiber sensor cannot be reset for a period of approximately 50 ms.

DIMENSIONS (Unit: mm in)

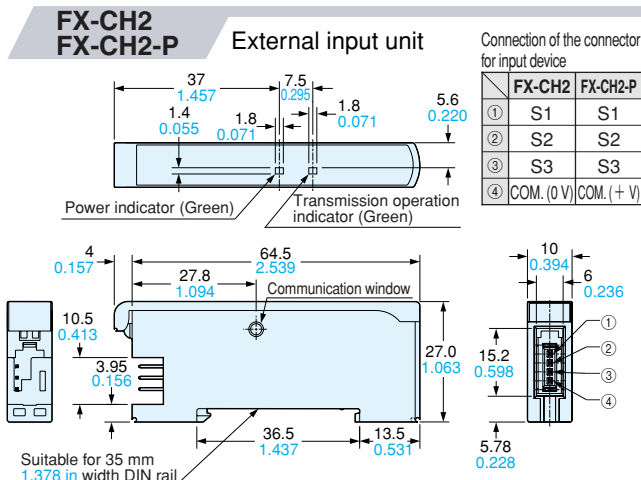

Upper Communication Unit for Digital Sensors / SC-GU1-485



**We now offer remote maintenance for sensors!
Also reduces the work required to the system
to start running!**



Centralized control and setting of scattered digital sensors (FX-301/305) is possible using a PLC or personal computer

<Touch screen monitor example>

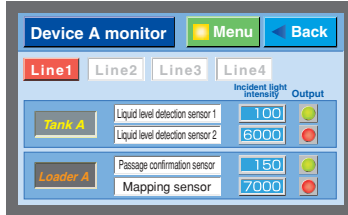

[Communicable commands]
 • Sensor incident light intensity
 • Sensor settings verification
 • Sensor output status
 • Threshold value settings, etc.

The sensor settings and operation can be checked on the touch screen, greatly improving ease of operation!

Ideal for workplaces such as semiconductor and LCD manufacturing lines where there are restrictions on operators entering and exiting

Example of use in semiconductor cleaning process

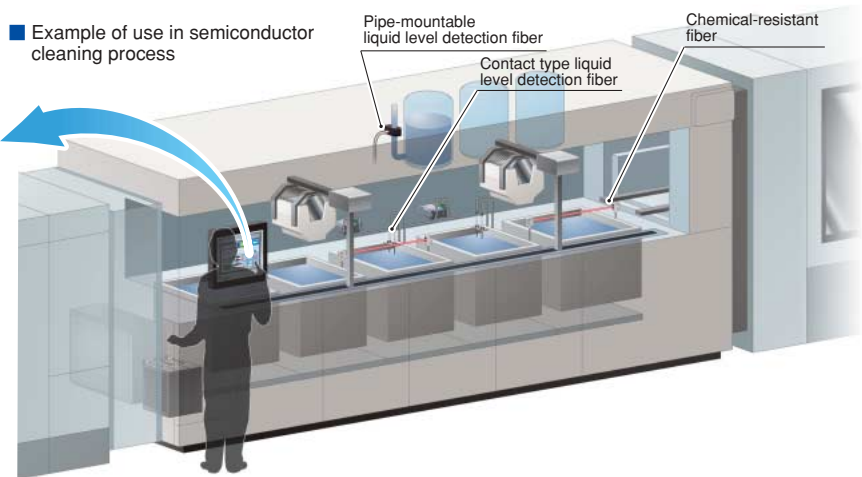

Control and settings can be carried out remotely

Setting and checking incident light intensity for digital sensors (FX-301/305) that are scattered inside and outside equipment can be carried out remotely for all sensors by using the SC-GU1-485, which greatly improves ease of operations such as monitoring equipment that is running and also equipment starting and maintenance.

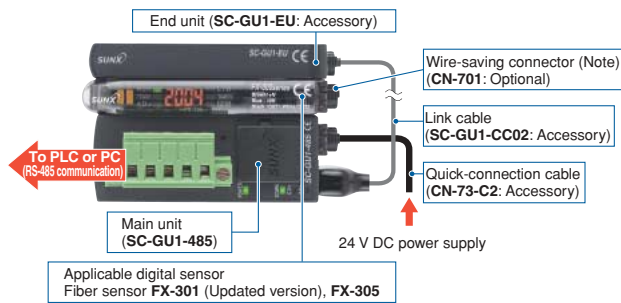

Note: Used when the output signal is sent via a SC-GU1-485 to the PLC. If the output signal is sent directly to the PLC, a quick-connection cable (CN-72-C□, CN-71-C□) should be used.

Less wiring and installation work

Up to a maximum of 16 sensors can be connected side by side. Power can be supplied to all of them at once, so that less wiring and installation work is required. Wire-saving connectors also makes it possible to send output signals to the PLC in a single batch.

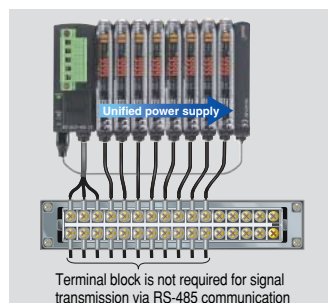

Communication speed 57.6 kbps

High-speed communication at a maximum speed of 57.6 kbps allows the operator to instantly check information such as the incident light intensity and output statuses of the digital sensors.

High general applicability so that any type of PLC can be used

RS-485 communication provides a high level of general compatibility so that any type of PLC can be used. Integration with existing systems is possible without the need to change PLCs.

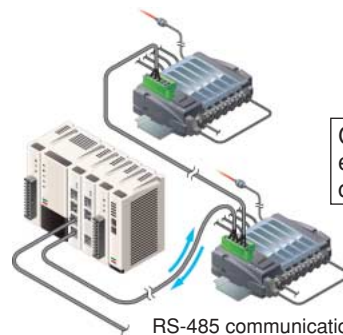

Compatible with all PLCs equipped with RS-485 compatible units

Series connection of a maximum of 31 nodes is possible

A maximum of 31 nodes can be connected in series. This is ideal for flexible handling when the sensors are to be installed in scattered locations or if more sensors are added.

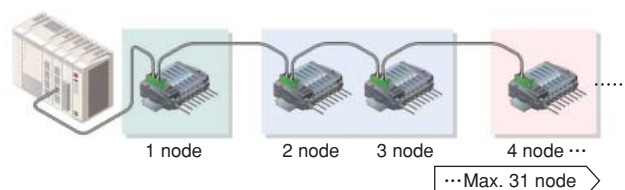

SPECIFICATIONS

Type	Main unit
Item	Model No. SC-GU1-485
Applicable sensor	FX-301(P) (Note), FX-305(P)
Connectable units	Max. 16 units of sensor per SC-GU1-485
Connectable nodes	Max. 31 nodes
Supply voltage	24 V DC \pm 10 % Ripple P-P10 % or less
Current consumption	45 mA or less (10 mA or less for SC-GU1-EU)
Communication method	2 wire half duplex method
Communication speed	57,600 bps / 38,400 bps / 19,200 bps / 9,600 bps Selectable by DIP switch
Synchronization method	Asynchronous communication method
Electrical characteristic	Conforming to EIA RS-485
Total extension length	Communication cable: 100 m 328.084 ft or less [SC-GU1-485 (termination) to PLC], Power supply cable: Less than 10 m 32.808 ft
Ambient temperature	-10 to +55 °C +14 to +131 °F (if 4 to 7 sensors are connected in cascade: -10 to +50 °C +14 to +122 °F , if 8 to 16 sensors are connected in cascade: -10 to +45 °C +14 to +113 °F)(No dew condensation or icing allowed), Storage: -20 to +70 °C -4 to +158 °F
Material	Enclosure: Heat-resistant ABS
Weight	35 g approx. (10 g approx. for SC-GU1-EU)
Accessories	SC-GU1-EU (End unit): 1 pc. CN-73-C2 [Quick-connection cable (cable length 2 m 6.562 ft): 1 pc. SC-GU1-CC02 [Link cable (cable length 0.2 m 0.656 ft): 1 pc.

Note: Applicable units are for the **FX-301(P)** after version update. Do not use the previous version of **FX-301(P)**.

The updated version of **FX-301(P)** has the 'NAVI' printed only on single side. (See the right figure.)

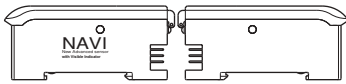

DIMENSIONS (Unit: mm in)

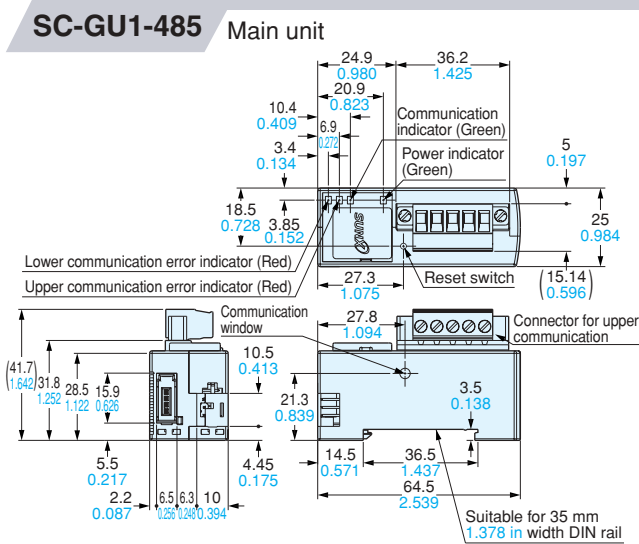

All information is subject to change without prior notice.

OPERATION VERIFICATION PROGRAM DOWNLOAD SERVICE

The SUNX website download data service lets you download operation verification programs to a personal computer. (<http://www.sunx.co.jp/>)

Monitoring example

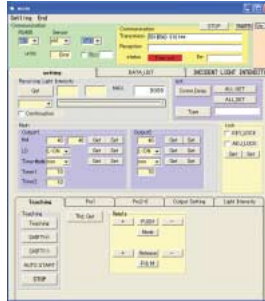

Operating environment

OS: Windows 98 Second Edition (standard English language installation only) or later
CPU: Pentium II 400 MHz processor or higher (Pentium III 450 MHz or higher recommended)
Memory: 64 MB or more (128 MB or more recommended)
Free hard disk space: 10 MB or more
Serial port: RS-232C compatible

Details that can be checked:

Sensor threshold values, output statuses, configuration settings, teaching and timer period setting changes, etc.

Notes: 1) Note the following when using this software.

The software is supplied as freeware. Copyright is retained by SUNX Limited. You must agree to the following conditions before using the software.

Conditions of use

• SUNX does not guarantee the correct operation of this software. SUNX takes no responsibility for any direct or indirect losses, damage, loss of profit or any other problems arising as a result of using or operating this software.

2) When connecting the **SC-GU1-485** to a personal computer, you will need obtain an interface converter (RS-232C \leftrightarrow RS-485 converter) and cable to connect between the computer and the interface converter.

OPTION

CN-701 (Wire-saving connector)

Note: Used when the output signal is sent via a **SC-GU1-485** to the PLC.

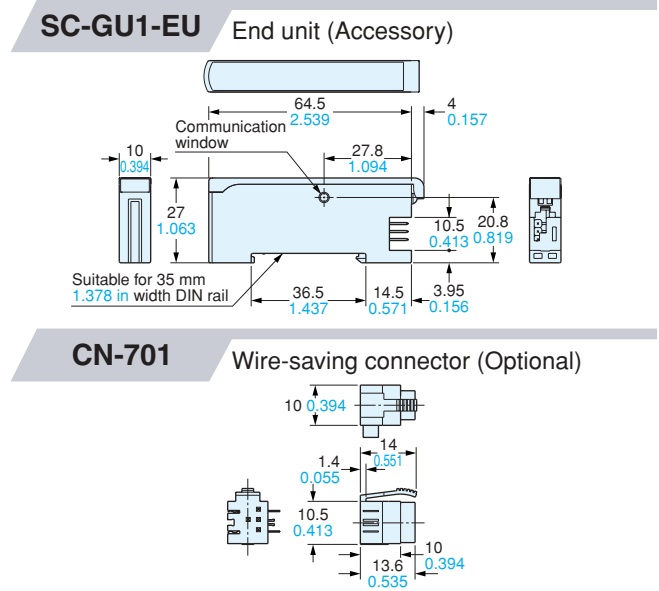

SUNX Limited

2431-1 Ushiyama-cho, Kasugai-shi, Aichi,
486-0901, Japan
Phone: +81-(0)568-33-7211
FAX: +81-(0)568-33-2631

Overseas Sales Dept.

Phone: +81-(0)568-33-7861
FAX: +81-(0)568-33-8591

<http://www.sunx.jp/>