

## General Description

The Micrel MIC37252 is a 2.5A low-dropout linear voltage regulator that provides a low voltage, high current output with a minimum of external components. It offers high precision, low dropout and low ground current.

The MIC37252 operates from an input voltage of 3.0V to 6.0V. It is designed to drive digital circuits requiring low voltage at high currents (i.e., PLDs, DSP, microcontroller, etc.). It is available in an adjustable output voltage capable of 1.24V to 5.5V.

Features of the MIC37252 LDO include thermal and current limit protection, and reverse current and reverse battery protection.

Junction temperature range of the MIC37252 is from  $-40^{\circ}\text{C}$  to  $+125^{\circ}\text{C}$ .

For higher currents see the MIC3730x family of LDOs.

## Features

- 2.5A minimum guaranteed output current
- **Ideal for 3.3V to 1.8V conversion**
- Stable with ceramic or tantalum capacitor
- $\pm 2.0\%$  initial output tolerance
- Dropout voltage = 550mV @ 2.5A
- Excellent line and load regulation specifications
- Logic controlled shutdown
- Thermal shutdown and current limit protection
- Reverse-leakage protection
- S-Pak and TO-263 packages

## Applications

- LDO linear regulator for low-voltage digital IC
- PC add-in cards
- High efficiency linear power supplies
- SMPS post regulator
- Battery charger

## Typical Application

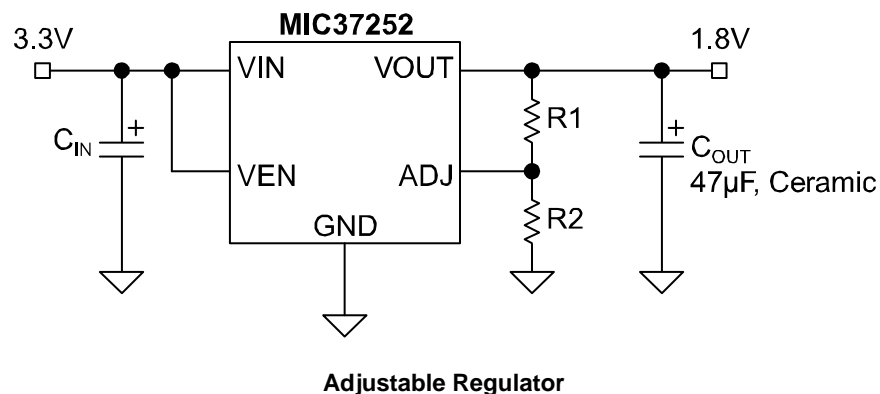

## Ordering Information

Part Number		Output Current	Voltage*	Junction Temperature Range	Package
Standard	RoHS Compliant**				
MIC37252BR	MIC37252WR	2.5A	Adj.	-40° to +125°C	S-Pak-5
MIC37252BU	MIC37252WU	2.5A	Adj.	-40° to +125°C	TO-263-5

\*For other voltages, please contact Micrel Marketing.

\*\*RoHS compliant with "high melting solder" exemption.

## Pin Configuration

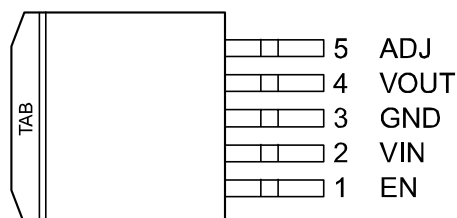

**S-PAK5 (R)**  
**TO-263 (U)**

## Pin Description

Pin Number	Pin Name	Pin Function
1	EN	Enable (Input): CMOS compatible input. Logic high = enable, logic low = shutdown.
2	VIN	Input voltage which supplies current to the output power device.
3	GND	Ground (TAB is connected to ground on S-Pak).
4	VOUT	Regulator Output.
5	ADJ	Adjustable regulator feedback input. Connect to resistor voltage divider.

**Absolute Maximum Ratings<sup>(1)</sup>**

Supply Voltage ( $V_{IN}$ ).....	6.5V
Enable Input Voltage ( $V_{EN}$ ).....	6.5V
Power Dissipation .....	Internally Limited
Junction Temperature .....	$-40^{\circ}\text{C} \leq T_J \leq +125^{\circ}\text{C}$
Storage Temperature .....	$-65^{\circ}\text{C} \leq T_J \leq +150^{\circ}\text{C}$
Lead Temperature (soldering, 5sec.).....	260°C
EDS <sup>(3)</sup>	

**Operating Ratings<sup>(2)</sup>**

Supply voltage ( $V_{IN}$ ) .....	3.0V to 6.0V
Enable Input Voltage ( $V_{EN}$ ).....	0V to 6.0V
Junction Temperature Range .....	$-40^{\circ}\text{C} \leq T_J \leq +125^{\circ}\text{C}$
Maximum Power Dissipation <sup>(4)</sup>	
Package Thermal Resistance	
S-Pak ( $\theta_{JC}$ ) .....	2°C/W
TO-263-5 ( $\theta_{JC}$ ).....	2°C/W

**Electrical Characteristics<sup>(5)</sup>**

$T_A = 25^{\circ}\text{C}$  with  $V_{IN} = V_{OUT} + 1\text{V}$ ;  $V_{EN} = V_{IN}$ ;  $I_L = 10\text{mA}$ , **bold** values indicate  $-40^{\circ}\text{C} < T_J < +125^{\circ}\text{C}$ , unless otherwise noted.

Parameter	Condition	Min	Typ	Max	Units
Output Voltage Accuracy	$I_L = 10\text{mA}$	-2		+2	%
	$10\text{mA} < I_{OUT} < I_{L(\text{max})}$ , $V_{OUT} + 1 \leq V_{IN} \leq 6\text{V}$	<b>-3</b>		<b>+3</b>	%
Output Voltage Line Regulation	$V_{IN} = V_{OUT} + 1.0\text{V}$ to 6.0V, $I_L = 10\text{mA}$		0.02	<b>0.5</b>	%
Output Voltage Load Regulation	$I_L = 10\text{mA}$ to 2.5A		0.2	<b>1</b>	%
$V_{IN} - V_{OUT}$ ; Dropout Voltage, <b>Note 6</b>	$I_L = 1.5\text{A}$		400	<b>500</b>	mV
	$I_L = 2.5\text{A}$		550	<b>1000</b>	mV
Ground Pin Current, <b>Note 7</b>	$I_L = 2.5\text{A}$		40	<b>60</b>	mA
Ground Pin Current in Shutdown	$V_{IL} \leq 0.5\text{V}$ , $V_{IN} = V_{OUT} + 1\text{V}$		1.0		$\mu\text{A}$
Current Limit	$V_{OUT} = 0$ ; $V_{IN} = 3.3\text{V}$		3		A
Start-up Time	$V_{EN} = V_{IN}$ , $I_{OUT} = 10\text{mA}$ , $C_{OUT} = 47\mu\text{F}$		150	<b>250</b>	$\mu\text{s}$
<b>Enable Input</b>					
Enable Input Threshold	Regulator enable	<b>2.25</b>			V
	Regulator shutdown			<b>0.8</b>	V
Enable Pin Input Current	$V_{IL} \leq 0.8\text{V}$ (Regulator shutdown)			2 <b>4</b>	$\mu\text{A}$ $\mu\text{A}$
	$V_{IH} \geq 2.25\text{V}$ (Regulator enable)	1	10	<b>30</b>	$\mu\text{A}$
Reference Voltage		1.215 <b>1.202</b>	1.240	1.265 <b>1.277</b>	V V
			40	80 <b>120</b>	nA nA

**Notes:**

- Exceeding the absolute maximum rating may damage the device.
- The device is not guaranteed to function outside its operating rating.
- Device is ESD sensitive. Handling precautions recommended.
- $P_{D(\text{max})} = T_{J(\text{max})} - T_A / \theta_{JA}$ , where  $\theta_{JA}$ , depends upon the printed circuit layout. See "Applications Information."
- Specification for packaged product only
- $V_{DO} = V_{IN} - V_{OUT}$  when  $V_{OUT}$  decreased to 98% of its nominal output voltage with  $V_{IN} = V_{OUT} + 1\text{V}$ . For output voltages below 2V, dropout voltage specification does not apply due to a minimum input operating voltage of 3V
- $I_{GND}$  is the quiescent current.  $I_{IN} = I_{GND} + I_{OUT}$ .

# Typical Characteristics

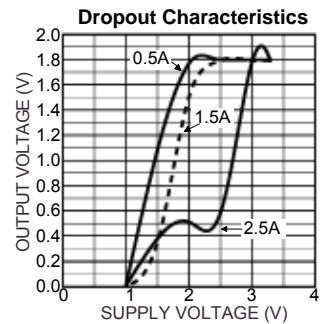
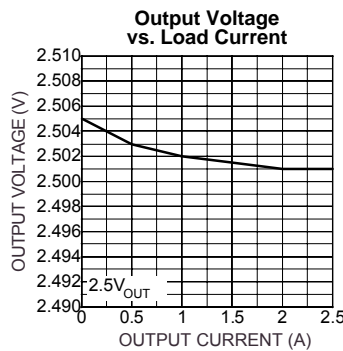
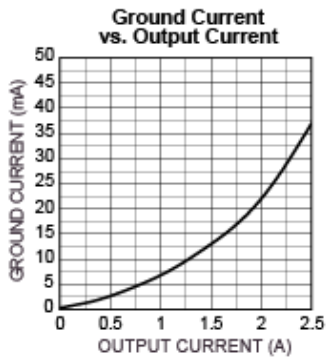
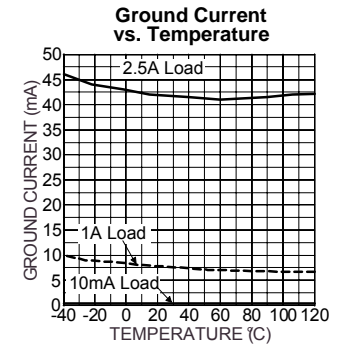
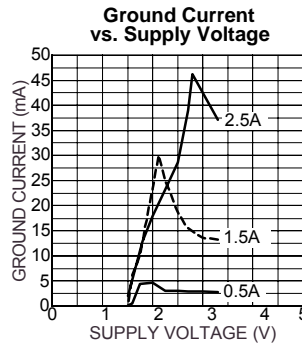
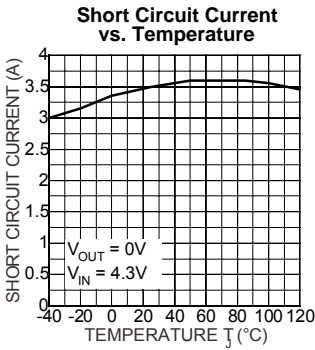
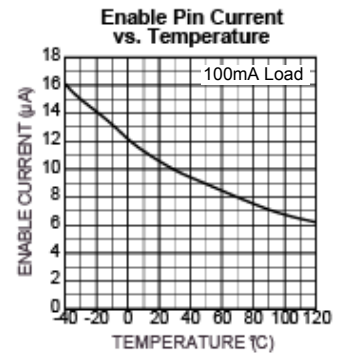
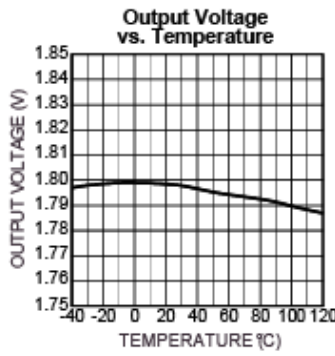
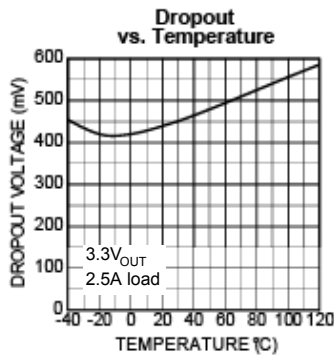
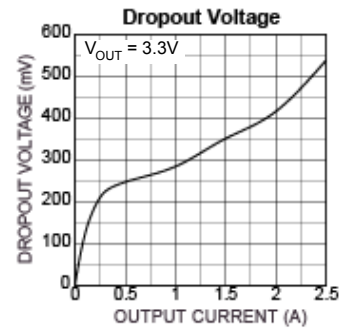
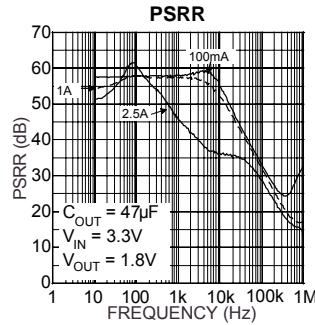
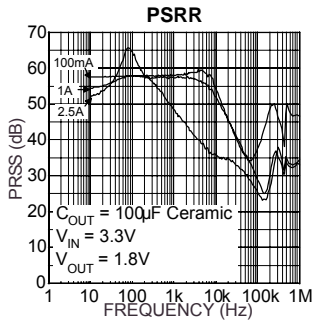

## Functional Characteristics

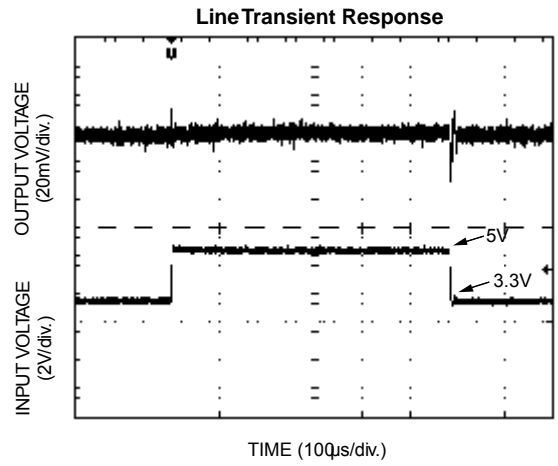
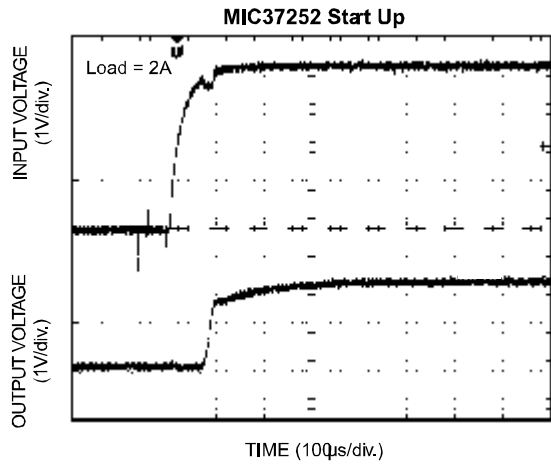
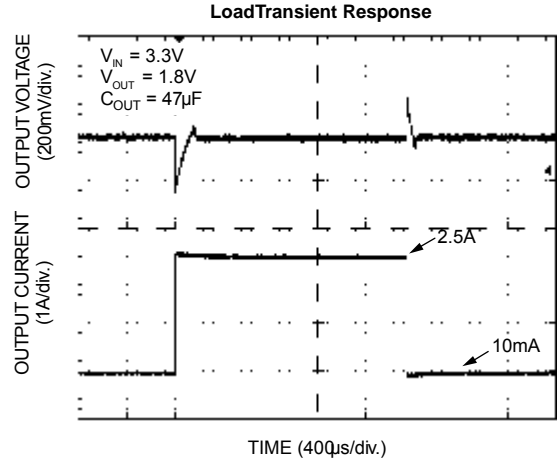
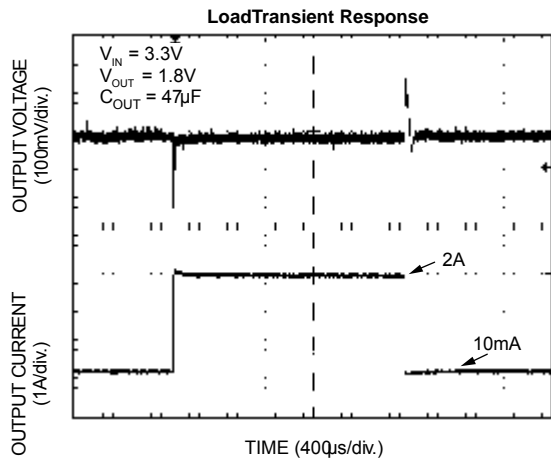

## Application Information

The MIC37252 is a high-performance low-dropout voltage regulator suitable for moderate to high-current regulator applications. Its 550mV dropout voltage at full load makes it especially valuable in battery-powered systems and as high-efficiency noise filters in post-regulator applications. Unlike older NPN-pass transistor designs, where the minimum dropout voltage is limited by the base-to-emitter voltage drop and collector-to-emitter saturation voltage, dropout performance of the PNP output of these devices is limited only by the low  $V_{CE}$  saturation voltage.

A trade off for the low dropout voltage is a varying base drive requirement. Micrel's Super  $\beta$  PNP<sup>®</sup> process reduces this drive requirement to only 2% to 5% of the load current.

The MIC37252 regulator is fully protected from damage due to fault conditions. Current limiting is provided. This limiting is linear; output current during overload conditions is constant. Thermal shutdown disables the device when the die temperature exceeds the maximum safe operating temperature. Transient protection allows device (and load) survival even when the input voltage spikes above and below nominal. The output structure of these regulators allows voltages in excess of the desired output voltage to be applied without reverse current flow.

### Thermal Design

Linear regulators are simple to use. The most complicated design parameters to consider are thermal characteristics. Thermal design requires the following application-specific parameters:

- Maximum ambient temperature ( $T_A$ )
- Output current ( $I_{OUT}$ )
- Output voltage ( $V_{OUT}$ )
- Input voltage ( $V_{IN}$ )
- Ground current ( $I_{GND}$ )

First, calculate the power dissipation of the regulator from these numbers and the device parameters from this datasheet.

$$P_D = (V_{IN} - V_{OUT}) I_{OUT} + V_{IN} I_{GND}$$

Where the ground current is approximated by using numbers from the "Electrical Characteristics" or "Typical Characteristics." Then the heat sink thermal resistance is determined with this formula:

$$\theta_{SA} = ((T_{J(MAX)} - T_A) / P_D) - (\theta_{JC} + \theta_{CS})$$

Where  $T_{J(MAX)} \leq 125^\circ\text{C}$  and  $\theta_{CS}$  is between  $0^\circ\text{C}$  and  $2^\circ\text{C/W}$ . The heat sink may be significantly reduced in

applications where the minimum input voltage is known and is large compared with the dropout voltage. Use a series input resistor to drop excessive voltage and distribute the heat between this resistor and the regulator. The low dropout properties of Micrel Super  $\beta$  PNP<sup>®</sup> regulators allow significant reductions in regulator power dissipation and the associated heat sink without compromising performance. When this technique is employed, a capacitor of at least 1.0 $\mu\text{F}$  is needed directly between the input and regulator ground. Refer to *Application Note 9* for further details and examples on thermal design and heat sink applications.

### Output Capacitor

The MIC37252 requires an output capacitor for stable operation. As a  $\mu\text{Cap}$  LDO, the MIC37252 can operate with ceramic output capacitors as long as the amount of capacitance is 47 $\mu\text{F}$  or greater. For values of output capacitance lower than 47 $\mu\text{F}$ , the recommended ESR range is 200m $\Omega$  to 2 $\Omega$ . The minimum value of output capacitance recommended for the MIC37252 is 10 $\mu\text{F}$ .

For 47 $\mu\text{F}$  or greater the ESR range recommended is less than 1 $\Omega$ . Ultra-low ESR, ceramic capacitors are recommended for output capacitance of 47 $\mu\text{F}$  or greater to help improve transient response and noise reduction at high frequency. X7R/X5R dielectric-type ceramic capacitors are recommended because of their temperature performance. X7R-type capacitors change capacitance by 15% over their operating temperature range and are the most stable type of ceramic capacitors. Z5U and Y5V dielectric capacitors change value by as much as 50% and 60% respectively over their operating temperature ranges. To use a ceramic chip capacitor with Y5V dielectric, the value must be much higher than an X7R ceramic capacitor to ensure the same minimum capacitance over the equivalent operating temperature range. The MIC37252 has excellent transient response to variations in input voltage and load current. The device has been designed to respond quickly to load current variations and input voltage variations. Large output capacitors are not required to obtain this performance. A standard 47 $\mu\text{F}$  output capacitor is all that is required. Larger values help to improve performance even further.

### Input Capacitor

An input capacitor of 1.0 $\mu\text{F}$  or greater is recommended when the device is more than 4 inches away from the bulk supply capacitance, or when the supply is a battery. Small, surface-mount chip capacitors can be used for the bypassing. The capacitor should be placed within 1" of the device for optimal performance. Larger values will help to improve ripple rejection by bypassing the input to the regulator, further improving the integrity of the output voltage.

### Transient Response and 5V to 3.3V or 3.3V to 1.8V Conversions

The MIC37252 has excellent transient response to variations in input voltage and load current. The device has been designed to respond quickly to load current variations and input voltage variations. Large output capacitors are not required to obtain this performance. A standard 10 $\mu$ F output capacitor, preferably tantalum, is all that is required. Larger values help to improve performance even further.

By virtue of its low dropout voltage, this device does not saturate into dropout as readily as similar NPN-based designs. When converting from 3.3V to 1.8V, the NPN-based regulators are already operating in dropout, with typical dropout requirements of 2V or greater. To convert down to 1.8V without operating in dropout, NPN-based regulators require an input voltage of 3.8V at the very least. The MIC37252 regulator will provide excellent performance with an input as low as 3.0V. This gives the PNP-based regulators a distinct advantage over older NPN-based linear regulators.

### Minimum Load Current

The MIC37252 regulator is specified between finite loads. If the output current is too small, leakage currents dominate and the output voltage rises. A 10mA minimum load current is necessary for proper operation.

### Enable Input

The MIC37252 also features an enable input for on/off control of the device. Its shutdown state draws “zero” current (only microamperes of leakage). The enable

input is TTL/CMOS compatible for simple logic interface, but can be connected to up to  $V_{IN}$ . When enabled, it draws approximately 15 $\mu$ A.

### Adjustable Regulator Design

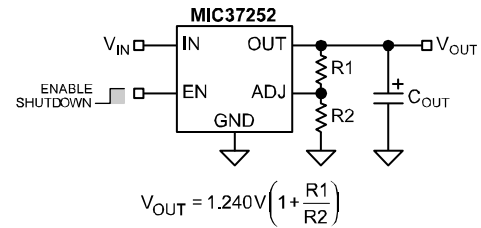

**Figure 2. Adjustable Regulator with Resistors**

The MIC37252 allows programming of the output voltage anywhere between 1.24V and the 5.5V maximum operating rating of the family. Two resistors are used. Resistor values are recommended to be less than 10k $\Omega$  in value to improve stability. The resistor values can be sized to draw the minimum load current for this device. The resistor values are calculated by:

$$R1 = R2 \left( \frac{V_{OUT}}{1.240} - 1 \right)$$

Where  $V_{OUT}$  is the desired output voltage. Figure 2 shows component definition. Applications with widely varying load currents may scale the resistors to draw the minimum load current required for proper operation (see above).

Package Information

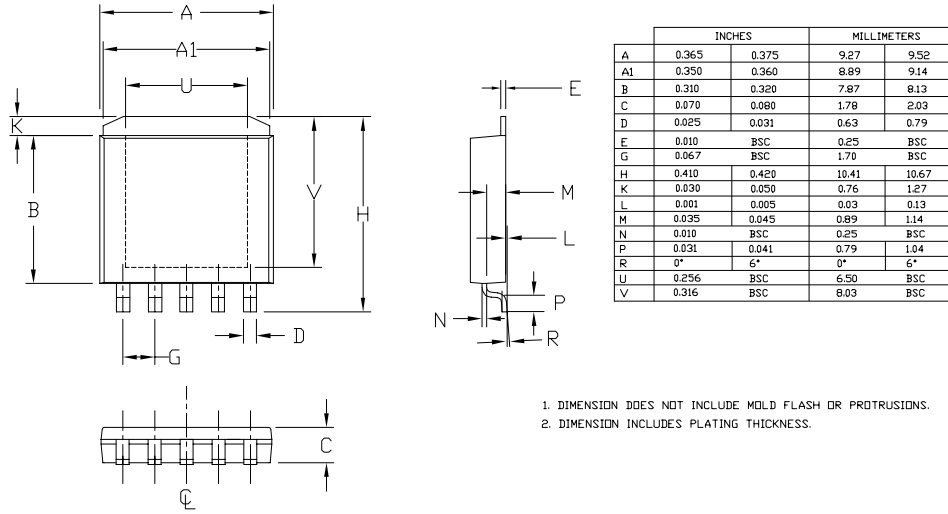

1. DIMENSION DOES NOT INCLUDE MOLD FLASH OR PROTRUSIONS.
2. DIMENSION INCLUDES PLATING THICKNESS.

5-Pin S-PAK (R)

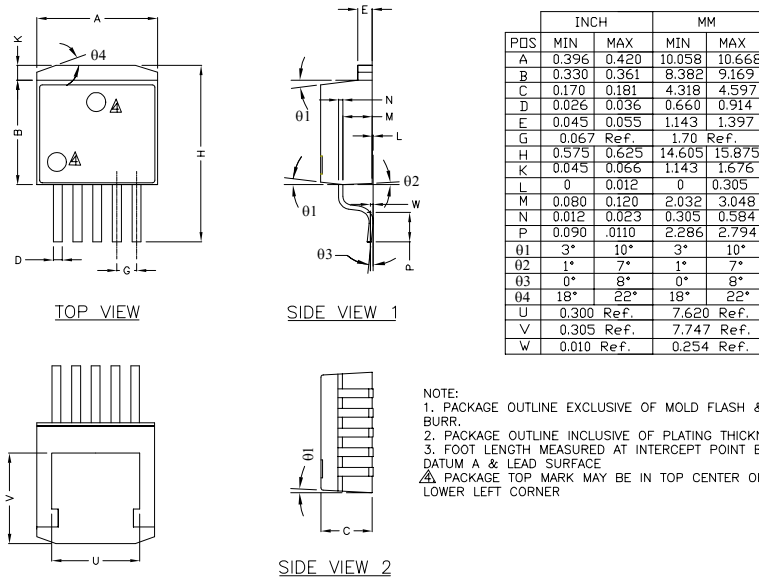

- NOTE:
1. PACKAGE OUTLINE EXCLUSIVE OF MOLD FLASH & METAL BURR.
  2. PACKAGE OUTLINE INCLUSIVE OF PLATING THICKNESS.
  3. FOOT LENGTH MEASURED AT INTERCEPT POINT BETWEEN DATUM A & LEAD SURFACE.
- ▲ PACKAGE TOP MARK MAY BE IN TOP CENTER OR LOWER LEFT CORNER

5-Pin TO-263 (U)

MICREL, INC. 2180 FORTUNE DRIVE SAN JOSE, CA 95131 USA  
 TEL +1 (408) 944-0800 FAX +1 (408) 474-1000 WEB <http://www.micrel.com>

The information furnished by Micrel in this data sheet is believed to be accurate and reliable. However, no responsibility is assumed by Micrel for its use. Micrel reserves the right to change circuitry and specifications at any time without notification to the customer.

Micrel Products are not designed or authorized for use as components in life support appliances, devices or systems where malfunction of a product can reasonably be expected to result in personal injury. Life support devices or systems are devices or systems that (a) are intended for surgical implant into the body or (b) support or sustain life, and whose failure to perform can be reasonably expected to result in a significant injury to the user. A Purchaser's use or sale of Micrel Products for use in life support appliances, devices or systems is a Purchaser's own risk and Purchaser agrees to fully indemnify Micrel for any damages resulting from such use or sale.

© 2002 Micrel, Incorporated.



# Mouser Electronics

Authorized Distributor

Click to View Pricing, Inventory, Delivery & Lifecycle Information:

[Microchip:](#)

[MIC37252WR](#) [MIC37252WU](#) [MIC37252WR-TR](#) [MIC37252WU-TR](#)