

2 Nm double ovoid 3.9 Watts 3.9 W Part number 82869007



- Torque rating of gearboxes : 2 Nm, high-performance plastic gears
- Motors : nominal power 3 W, interference suppression for standard stocked products
- Wide speed range : 0.3 to 430 rpm
- Optional encoder built into the motor

Part numbers

	Type	Type	Voltage	Output speed (rpm)	Ratios (i)
82869007	3.9 W	828690	12 V	27	160

Specifications

General characteristics

Motor	828600
Gearbox	810330
Maximum permitted torque from gearmotor under continuous conditions for 1 million turns (Nm)	2
Axial load static (daN)	1
Radial load static (daN)	10
Max. output power (W)	3,9
Nominal output (W)	3
Gearbox case temperature rise (°C)	50
Weight (g)	240

Made to order products, available on request

Motors :

- Other supply voltages
- Motor with 2 ball bearings
- Shaft lengths at front and/or rear
- Lead outputs or radial tag terminals
- Special interference suppression
- Encoder : 5 pulses/rev

Gearboxes :

- Special shaft
- Ball bearings
- Special greasing
- Torque limiter F
- Gearbox fixing M3
- Other speeds

Dimensions (mm)

828690

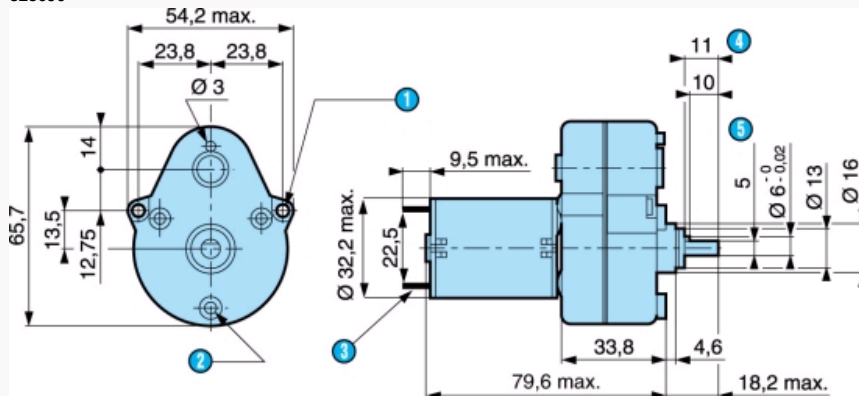

N°	Legend
1	2 fixing holes $\text{Ø} 3.2$
2	3 bosses $\text{Ø} 7.2$ at 120° on $R=19.5$ with M3 holes

①	2 standard tags NFC 20-120, series 2.8 x 0.5 mm
②	Shaft pushed-in
③	5 across flats

Dimensions (mm)

Shaft 79202573

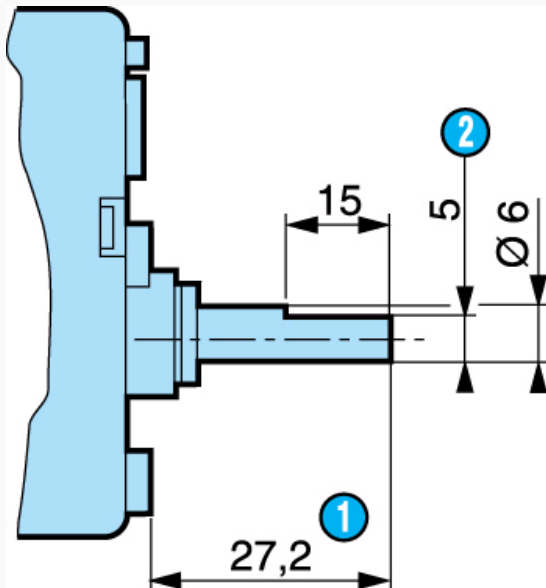

N°	Legend
①	Shaft pushed-in
②	5 across flats

Curves

Curve : torque/nominal speed

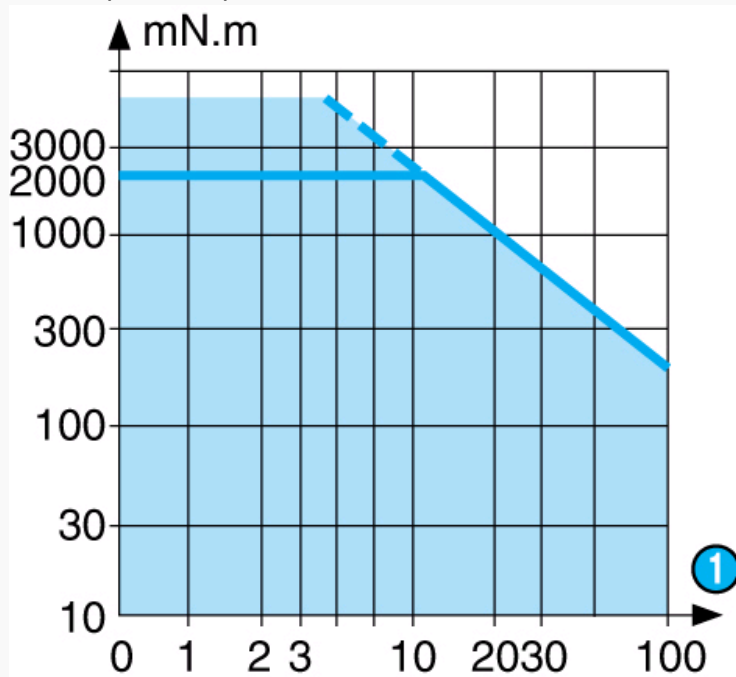

N°	Legend
①	rpm

Product adaptations

- Special supply voltage
- Lead output
- 1 or 5 pulse Hall effect encoder
- Special connectors
- Special shaft
- Special reduction ratio
- Special materials for gears
- Special ball bearings
- Special adaptor plate
- Finishing and system Y
- More than 200 reduction ratios available
- With shorter 1 W motor

Mouser Electronics

Authorized Distributor

Click to View Pricing, Inventory, Delivery & Lifecycle Information:

[Crouzet:](#)

[82869007](#)