

TIP140, TIP141, TIP142, (NPN); TIP145, TIP146, TIP147, (PNP)



ON Semiconductor®

<http://onsemi.com>

Darlington Complementary Silicon Power Transistors

Designed for general-purpose amplifier and low frequency switching applications.

Features

- High DC Current Gain –
 $\text{Min } h_{FE} = 1000 @ I_C$
 $= 5.0 \text{ A, } V_{CE} = 4 \text{ V}$
- Collector–Emitter Sustaining Voltage – @ 30 mA
 $V_{CEO(sus)} = 60 \text{ Vdc (Min) – TIP140, TIP145}$
 $= 80 \text{ Vdc (Min) – TIP141, TIP146}$
 $= 100 \text{ Vdc (Min) – TIP142, TIP147}$
- Monolithic Construction with Built–In Base–Emitter Shunt Resistor
- These are Pb–Free Devices*

MAXIMUM RATINGS

Rating	Symbol	TIP140 TIP145	TIP141 TIP146	TIP142 TIP147	Unit
Collector – Emitter Voltage	V_{CEO}	60	80	100	Vdc
Collector – Base Voltage	V_{CB}	60	80	100	Vdc
Emitter – Base Voltage	V_{EB}	5.0			Vdc
Collector Current	I_C				Adc
– Continuous		10			
– Peak (Note 1)		15			
Base Current – Continuous	I_B	0.5			Adc
Total Power Dissipation @ $T_C = 25^\circ\text{C}$	P_D	125			W
Operating and Storage Junction Temperature Range	T_J, T_{stg}	–65 to +150			$^\circ\text{C}$

THERMAL CHARACTERISTICS

Characteristic	Symbol	Max	Unit
Thermal Resistance, Junction–to–Case	$R_{\theta JC}$	1.0	$^\circ\text{C/W}$
Thermal Resistance, Junction–to–Ambient	$R_{\theta JA}$	35.7	$^\circ\text{C/W}$

Stresses exceeding Maximum Ratings may damage the device. Maximum Ratings are stress ratings only. Functional operation above the Recommended Operating Conditions is not implied. Extended exposure to stresses above the Recommended Operating Conditions may affect device reliability.

1. 5 ms, $\leq 10\%$ Duty Cycle.

*For additional information on our Pb–Free strategy and soldering details, please download the ON Semiconductor Soldering and Mounting Techniques Reference Manual, SOLDERRM/D.

10 AMPERE DARLINGTON COMPLEMENTARY SILICON POWER TRANSISTORS 60–100 VOLTS, 125 WATTS

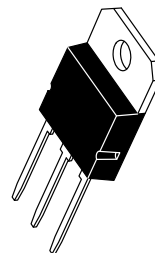

SOT-93 (TO-218)
CASE 340D
STYLE 1

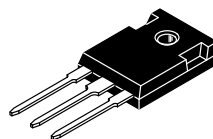

TO-247
CASE 340L
STYLE 3

NOTE: Effective June 2012 this device will be available only in the TO-247 package. Reference FPCN# 16827.

ORDERING INFORMATION

See detailed ordering and shipping information in the package dimensions section on page 2 of this data sheet.

TIP140, TIP141, TIP142, (NPN); TIP145, TIP146, TIP147, (PNP)

MARKING DIAGRAMS

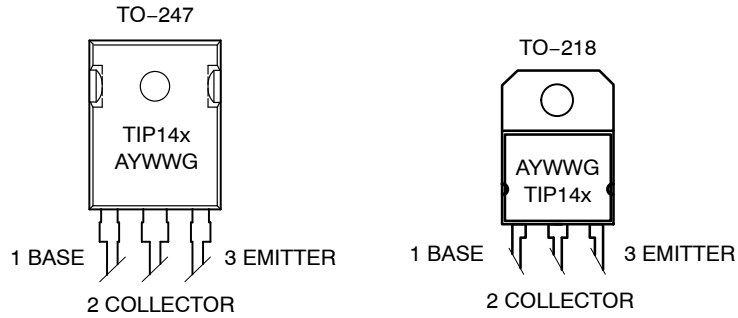

TIP14x = Device Code
 A = Assembly Location
 Y = Year
 WW = Work Week
 G = Pb-Free Package

DARLINGTON SCHEMATICS



ORDERING INFORMATION

Device	Package	Shipping
TIP140G	SOT-93 (TO-218) (Pb-Free)	30 Units / Rail
TIP141G	SOT-93 (TO-218) (Pb-Free)	30 Units / Rail
TIP142G	SOT-93 (TO-218) (Pb-Free)	30 Units / Rail
TIP145G	SOT-93 (TO-218) (Pb-Free)	30 Units / Rail
TIP146G	SOT-93 (TO-218) (Pb-Free)	30 Units / Rail
TIP147G	SOT-93 (TO-218) (Pb-Free)	30 Units / Rail
TIP140G	TO-247 (Pb-Free)	30 Units / Rail
TIP141G	TO-247 (Pb-Free)	30 Units / Rail
TIP142G	TO-247 (Pb-Free)	30 Units / Rail
TIP145G	TO-247 (Pb-Free)	30 Units / Rail
TIP146G	TO-247 (Pb-Free)	30 Units / Rail
TIP147G	TO-247 (Pb-Free)	30 Units / Rail

TIP140, TIP141, TIP142, (NPN); TIP145, TIP146, TIP147, (PNP)

ELECTRICAL CHARACTERISTICS ($T_C = 25^\circ\text{C}$ unless otherwise noted)

Characteristic	Symbol	Min	Typ	Max	Unit
OFF CHARACTERISTICS					
Collector-Emitter Sustaining Voltage (Note 2) ($I_C = 30\text{ mA}$, $I_B = 0$)	$V_{CEO(sus)}$	60 80 100	- - -	- - -	Vdc
Collector Cutoff Current ($V_{CE} = 30\text{ Vdc}$, $I_B = 0$) ($V_{CE} = 40\text{ Vdc}$, $I_B = 0$) ($V_{CE} = 50\text{ Vdc}$, $I_B = 0$)	I_{CEO}	- - -	- - -	2.0 2.0 2.0	mA
Collector Cutoff Current ($V_{CB} = 60\text{ V}$, $I_E = 0$) ($V_{CB} = 80\text{ V}$, $I_E = 0$) ($V_{CB} = 100\text{ V}$, $I_E = 0$)	I_{CBO}	- - -	- - -	1.0 1.0 1.0	mA
Emitter Cutoff Current ($V_{BE} = 5.0\text{ V}$)	I_{EBO}	-	-	2.0	mA

ON CHARACTERISTICS (Note 2)

DC Current Gain ($I_C = 5.0\text{ A}$, $V_{CE} = 4.0\text{ V}$) ($I_C = 10\text{ A}$, $V_{CE} = 4.0\text{ V}$)	h_{FE}	1000 500	- -	- -	-
Collector-Emitter Saturation Voltage ($I_C = 5.0\text{ A}$, $I_B = 10\text{ mA}$) ($I_C = 10\text{ A}$, $I_B = 40\text{ mA}$)	$V_{CE(sat)}$	- -	- -	2.0 3.0	Vdc
Base-Emitter Saturation Voltage ($I_C = 10\text{ A}$, $I_B = 40\text{ mA}$)	$V_{BE(sat)}$	-	-	3.5	Vdc
Base-Emitter On Voltage ($I_C = 10\text{ A}$, $V_{CE} = 4.0\text{ Vdc}$)	$V_{BE(on)}$	-	-	3.0	Vdc

SWITCHING CHARACTERISTICS

Resistive Load (See Figure 1)						
Delay Time	$(V_{CC} = 30\text{ V}$, $I_C = 5.0\text{ A}$, $I_B = 20\text{ mA}$, Duty Cycle $\leq 2.0\%$, $I_{B1} = I_{B2}$, R_C & R_B Varied, $T_J = 25^\circ\text{C}$)	t_d	-	0.15	-	μs
Rise Time		t_r	-	0.55	-	μs
Storage Time		t_s	-	2.5	-	μs
Fall Time		t_f	-	2.5	-	μs

2. Pulse Test: Pulse Width = 300 μs , Duty Cycle $\leq 2.0\%$.

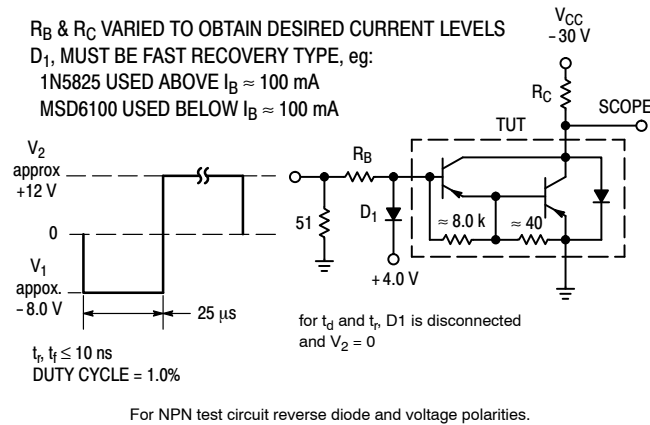

Figure 1. Switching Times Test Circuit

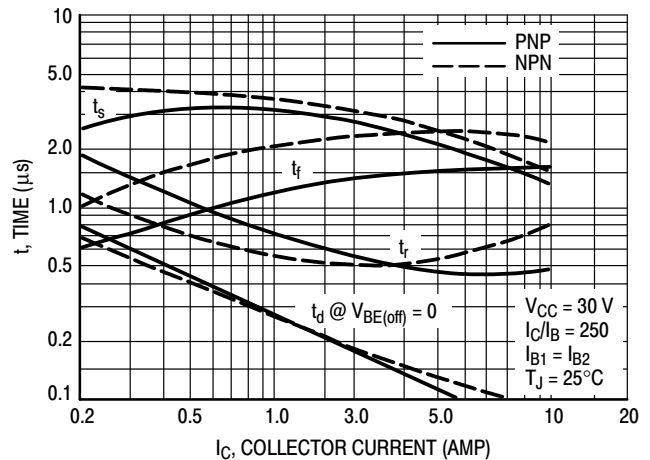

Figure 2. Switching Times

TIP140, TIP141, TIP142, (NPN); TIP145, TIP146, TIP147, (PNP)

TYPICAL CHARACTERISTICS

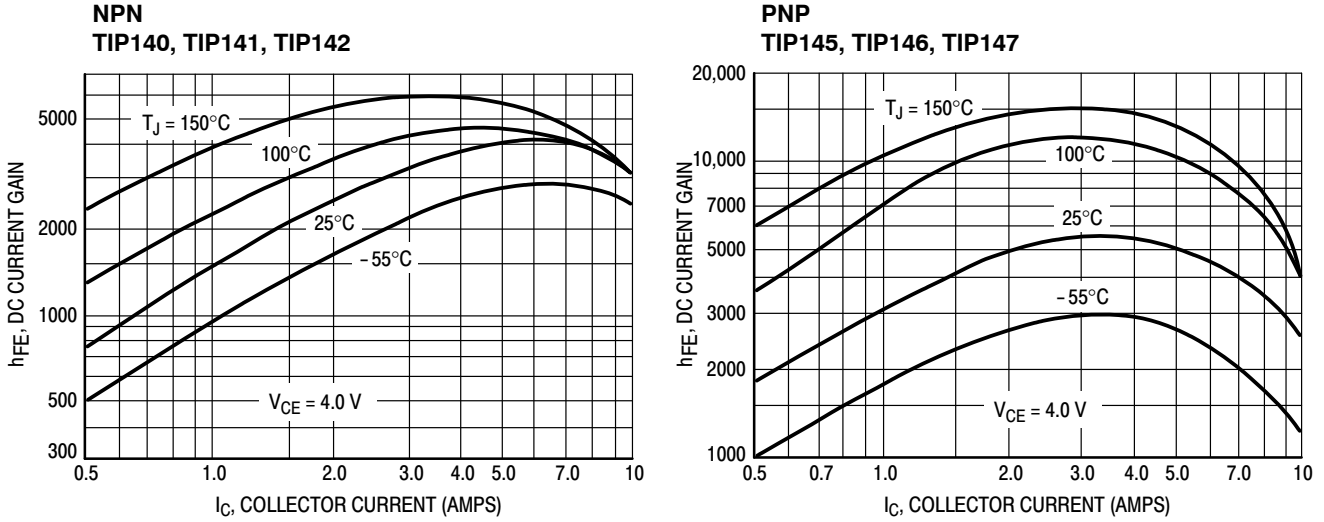

Figure 3. DC Current Gain versus Collector Current

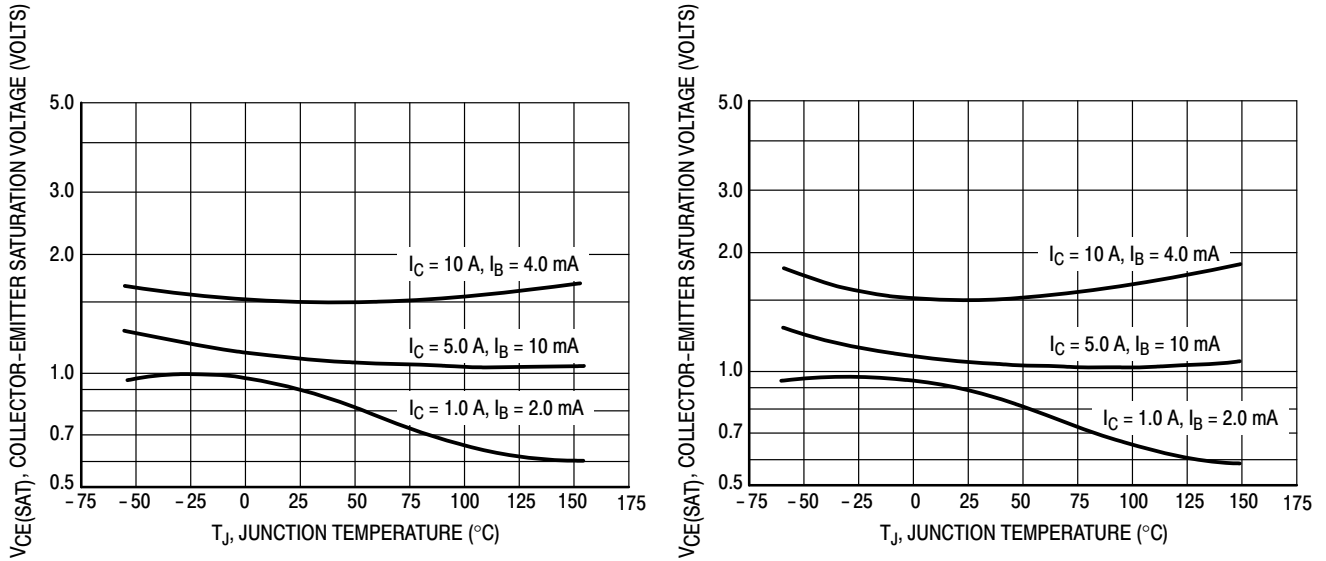

Figure 4. Collector-Emitter Saturation Voltage

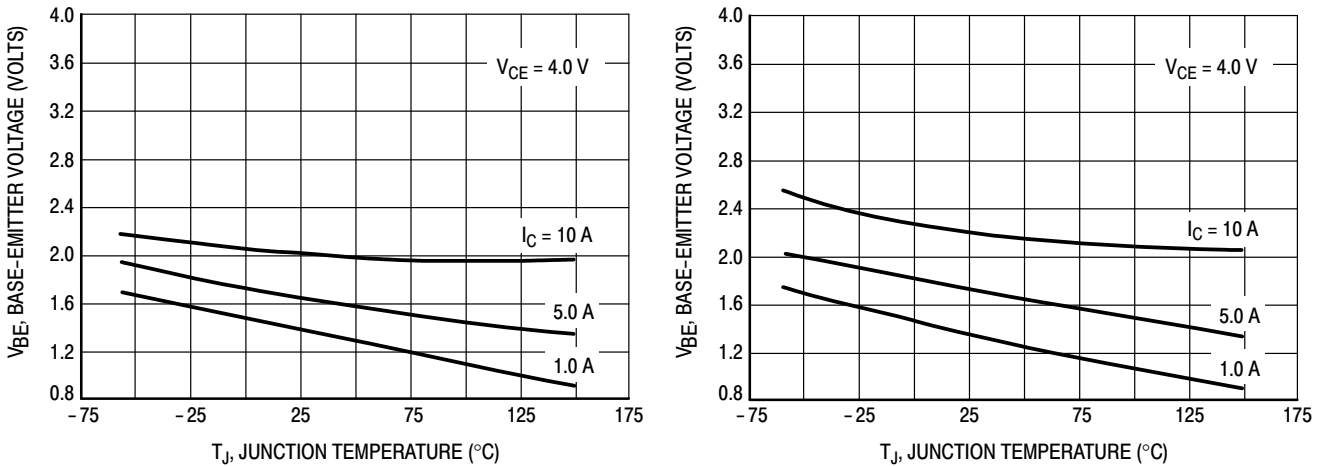

Figure 5. Base-Emitter Voltage

TIP140, TIP141, TIP142, (NPN); TIP145, TIP146, TIP147, (PNP)

ACTIVE-REGION SAFE OPERATING AREA

There are two limitations on the power handling ability of a transistor: average junction temperature and second breakdown. Safe operating area curves indicate $I_C - V_{CE}$ limits of the transistor that must be observed for reliable operation; i.e., the transistor must not be subjected to greater dissipation than the curves indicate.

The data of Figure 6 is based on $T_{J(pk)} = 150^\circ\text{C}$; T_C is variable depending on conditions. At high case temperatures, thermal limitations will reduce the power that can be handled to values less than the limitations imposed by second breakdown.

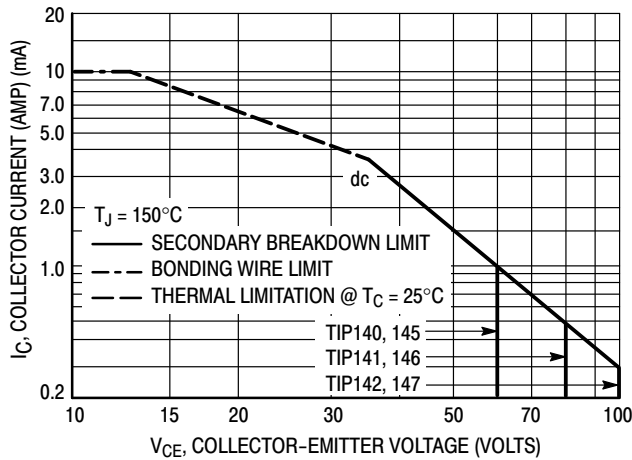

Figure 6. Active-Region Safe Operating Area

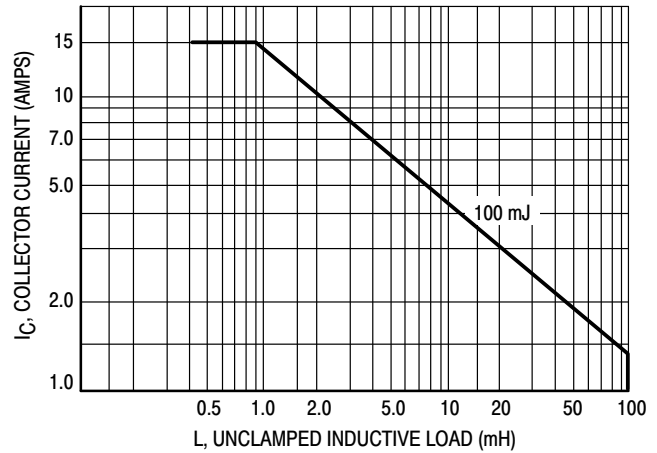
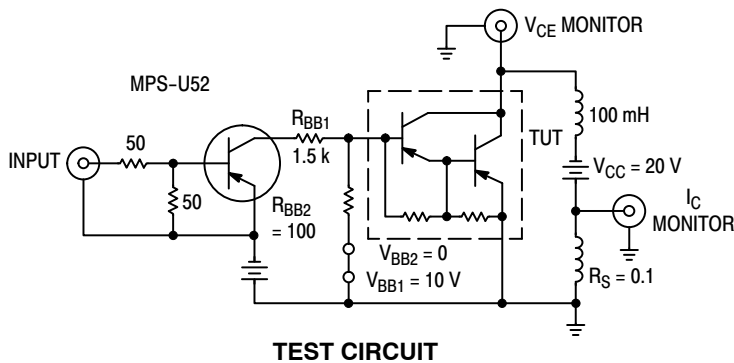
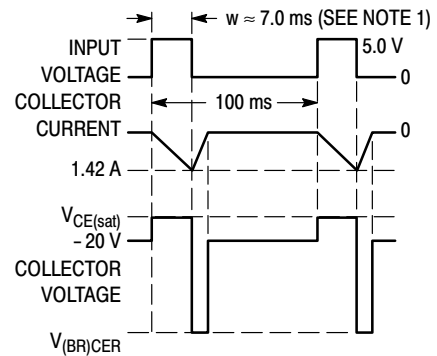

Figure 7. Unclamped Inductive Load



TEST CIRCUIT

NOTE 1: Input pulse width is increased until $I_{CM} = 1.42\text{ A}$.
NOTE 2: For NPN test circuit reverse polarities.



VOLTAGE AND CURRENT WAVEFORMS

Figure 8. Inductive Load

TIP140, TIP141, TIP142, (NPN); TIP145, TIP146, TIP147, (PNP)

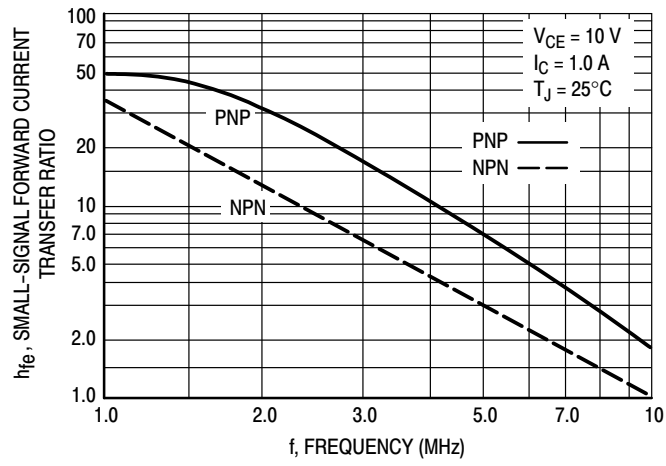

Figure 9. Magnitude of Common Emitter Small-Signal Short-Circuit Forward Current Transfer Ratio

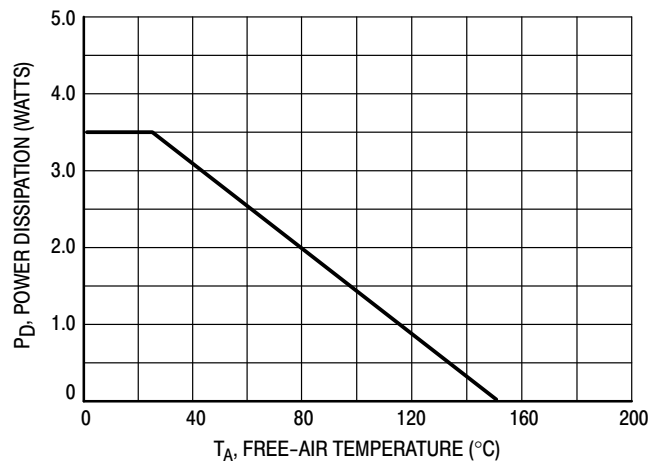

Figure 10. Free-Air Temperature Power Derating

TIP140, TIP141, TIP142, (NPN); TIP145, TIP146, TIP147, (PNP)

PACKAGE DIMENSIONS

SOT-93 (TO-218) CASE 340D-02 ISSUE E



- NOTES:
1. DIMENSIONING AND TOLERANCING PER ANSI Y14.5M, 1982.
2. CONTROLLING DIMENSION: MILLIMETER.

DIM	MILLIMETERS		INCHES	
	MIN	MAX	MIN	MAX
A	---	20.35	---	0.801
B	14.70	15.20	0.579	0.598
C	4.70	4.90	0.185	0.193
D	1.10	1.30	0.043	0.051
E	1.17	1.37	0.046	0.054
G	5.40	5.55	0.213	0.219
H	2.00	3.00	0.079	0.118
J	0.50	0.78	0.020	0.031
K	31.00 REF		1.220 REF	
L	---	16.20	---	0.638
Q	4.00	4.10	0.158	0.161
S	17.80	18.20	0.701	0.717
U	4.00 REF		0.157 REF	
V	1.75 REF		0.069	

- STYLE 1:
PIN 1. BASE
2. COLLECTOR
3. EMITTER
4. COLLECTOR

TO-247 CASE 340L-02 ISSUE F



- NOTES:
1. DIMENSIONING AND TOLERANCING PER ANSI Y14.5M, 1982.
2. CONTROLLING DIMENSION: MILLIMETER.

DIM	MILLIMETERS		INCHES	
	MIN	MAX	MIN	MAX
A	20.32	21.08	0.800	0.830
B	15.75	16.26	0.620	0.640
C	4.70	5.30	0.185	0.209
D	1.00	1.40	0.040	0.055
E	1.90	2.60	0.075	0.102
F	1.65	2.13	0.065	0.084
G	5.45 BSC		0.215 BSC	
H	1.50	2.49	0.059	0.098
J	0.40	0.80	0.016	0.031
K	19.81	20.83	0.780	0.820
L	5.40	6.20	0.212	0.244
N	4.32	5.49	0.170	0.216
P	---	4.50	---	0.177
Q	3.55	3.65	0.140	0.144
U	6.15 BSC		0.242 BSC	
W	2.87	3.12	0.113	0.123

- STYLE 3:
PIN 1. BASE
2. COLLECTOR
3. EMITTER
4. COLLECTOR

TIP140, TIP141, TIP142, (NPN); TIP145, TIP146, TIP147, (PNP)

ON Semiconductor and  are registered trademarks of Semiconductor Components Industries, LLC (SCILLC). SCILLC reserves the right to make changes without further notice to any products herein. SCILLC makes no warranty, representation or guarantee regarding the suitability of its products for any particular purpose, nor does SCILLC assume any liability arising out of the application or use of any product or circuit, and specifically disclaims any and all liability, including without limitation special, consequential or incidental damages. "Typical" parameters which may be provided in SCILLC data sheets and/or specifications can and do vary in different applications and actual performance may vary over time. All operating parameters, including "Typicals" must be validated for each customer application by customer's technical experts. SCILLC does not convey any license under its patent rights nor the rights of others. SCILLC products are not designed, intended, or authorized for use as components in systems intended for surgical implant into the body, or other applications intended to support or sustain life, or for any other application in which the failure of the SCILLC product could create a situation where personal injury or death may occur. Should Buyer purchase or use SCILLC products for any such unintended or unauthorized application, Buyer shall indemnify and hold SCILLC and its officers, employees, subsidiaries, affiliates, and distributors harmless against all claims, costs, damages, and expenses, and reasonable attorney fees arising out of, directly or indirectly, any claim of personal injury or death associated with such unintended or unauthorized use, even if such claim alleges that SCILLC was negligent regarding the design or manufacture of the part. SCILLC is an Equal Opportunity/Affirmative Action Employer. This literature is subject to all applicable copyright laws and is not for resale in any manner.

PUBLICATION ORDERING INFORMATION

LITERATURE FULFILLMENT:

Literature Distribution Center for ON Semiconductor
P.O. Box 5163, Denver, Colorado 80217 USA
Phone: 303-675-2175 or 800-344-3860 Toll Free USA/Canada
Fax: 303-675-2176 or 800-344-3867 Toll Free USA/Canada
Email: orderlit@onsemi.com

N. American Technical Support: 800-282-9855 Toll Free
USA/Canada
Europe, Middle East and Africa Technical Support:
Phone: 421 33 790 2910
Japan Customer Focus Center
Phone: 81-3-5817-1050

ON Semiconductor Website: www.onsemi.com
Order Literature: <http://www.onsemi.com/orderlit>
For additional information, please contact your local
Sales Representative

Mouser Electronics

Authorized Distributor

Click to View Pricing, Inventory, Delivery & Lifecycle Information:

[ON Semiconductor:](#)

[TIP141G](#) [TIP147G](#) [TIP140G](#) [TIP142G](#)