

Features

- Ultra-Small Surface Mount Package
- Planar Die Construction
- **Lead Free/RoHS Compliant (Note 2)**
- **"Green" Device (Note 3 and 4)**

Mechanical Data

- Case: SOT-523
- Case Material: Molded Plastic. UL Flammability Classification Rating 94V-0
- Moisture Sensitivity: Level 1 per J-STD-020D
- Terminals: Solderable per MIL-STD-202, Method 208
- Lead Free Plating (Matte Tin Finish annealed over Alloy 42 leadframe).
- Polarity: See Diagram
- Marking Information: See Page 3
- Ordering Information: See Page 3
- Weight: 0.002 grams (approximate)



Top View

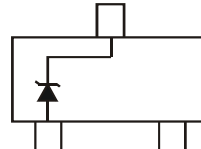

Device Schematic

Maximum Ratings @ $T_A = 25^\circ\text{C}$ unless otherwise specified

Characteristic	Symbol	Value	Unit
Forward Voltage @ $I_F = 10\text{mA}$	V_F	0.9	V

Thermal Characteristics

Characteristic	Symbol	Value	Unit
Power Dissipation (Note 1)	P_D	150	mW
Thermal Resistance, Junction to Ambient Air (Note 1)	$R_{\theta JA}$	833	$^\circ\text{C/W}$
Operating and Storage Temperature Range	T_J, T_{STG}	-65 to +150	$^\circ\text{C}$

- Notes:
1. Device mounted on FR-4 PC board with recommended pad layout at <http://www.diodes.com/datasheets/ap02001.pdf>.
 2. No purposefully added lead.
 3. Diodes Inc.'s "Green" policy can be found on our website at http://www.diodes.com/products/lead_free/index.php.
 4. Product manufactured with Date Code UO (week 40, 2007) and newer are built with Green Molding Compound. Product manufactured prior to Date Code UO are built with Non-Green Molding Compound and may contain Halogens or Sb2O3 Fire Retardants.

Electrical Characteristics @ $T_A = 25^\circ\text{C}$ unless otherwise specified

Type Number	Marking Code	Zener Voltage Range (Note 5)				Maximum Zener Impedance (Note 6)			Maximum Reverse Current (Note 5)		Temperature Coefficient of Zener Voltage @ $I_{ZT} = 5\text{mA}$ ($\text{mV}/^\circ\text{C}$)	
		$V_Z @ I_{ZT}$			I_{ZT}	$Z_{ZT} @ I_{ZT}$	$Z_{ZK} @ I_{ZK}$	I_{ZK}	I_R	@ V_R	Min	Max
		Nom (V)	Min (V)	Max (V)	mA	Ω	mA	μA	V			
BZX84C2V4T	RB	2.4	2.2	2.6	5.0	100	600	1.0	50	1.0	-3.5	0
BZX84C2V7T	RC	2.7	2.5	2.9	5.0	100	600	1.0	20	1.0	-3.5	0
BZX84C3V0T	RD	3.0	2.8	3.2	5.0	95	600	1.0	20	1.0	-3.5	0
BZX84C3V3T	RE	3.3	3.1	3.5	5.0	95	600	1.0	5.0	1.0	-3.5	0
BZX84C3V6T	RF	3.6	3.4	3.8	5.0	90	600	1.0	5.0	1.0	-3.5	0
BZX84C3V9T	RG	3.9	3.7	4.1	5.0	90	600	1.0	3.0	1.0	-3.5	0
BZX84C4V3T	RH	4.3	4.0	4.6	5.0	90	600	1.0	3.0	1.0	-3.5	0
BZX84C4V7T	R1	4.7	4.4	5.0	5.0	80	600	1.0	3.0	2.0	-3.5	0.2
BZX84C5V1T	R2	5.1	4.8	5.4	5.0	60	500	1.0	2.0	2.0	-2.7	1.2
BZX84C5V6T	R3	5.6	5.2	6.0	5.0	40	480	1.0	1.0	2.0	-2.0	2.5
BZX84C6V2T	R4	6.2	5.8	6.6	5.0	10	400	1.0	3.0	4.0	0.4	3.7
BZX84C6V8T	R5	6.8	6.4	7.2	5.0	15	150	1.0	2.0	4.0	1.2	4.5
BZX84C7V5T	R6	7.5	7.0	7.9	5.0	15	80	1.0	1.0	5.0	2.5	5.3
BZX84C8V2T	R7	8.2	7.7	8.7	5.0	15	80	1.0	0.7	5.0	3.2	6.2
BZX84C9V1T	R8	9.1	8.5	9.6	5.0	15	80	1.0	0.5	6.0	3.8	7.0
BZX84C10T	R9	10	9.4	10.6	5.0	20	100	1.0	0.2	7.0	4.5	8.0
BZX84C11T	P1	11	10.4	11.6	5.0	20	150	1.0	0.1	8.0	5.4	9.0
BZX84C12T	P2	12	11.4	12.7	5.0	25	150	1.0	0.1	8.0	6.0	10.0
BZX84C13T	P3	13	12.4	14.1	5.0	30	150	1.0	0.1	8.0	7.0	11.0
BZX84C15T	P4	15	13.8	15.6	5.0	30	170	1.0	0.1	10.5	9.2	13.0
BZX84C16T	P5	16	15.3	17.1	5.0	40	200	1.0	0.1	11.2	10.4	14.0
BZX84C18T	P6	18	16.8	19.1	5.0	45	200	1.0	0.1	12.6	12.4	16.0
BZX84C20T	P7	20	18.8	21.2	5.0	55	225	1.0	0.1	14.0	14.4	18.0
BZX84C22T	P8	22	20.8	23.3	5.0	55	225	1.0	0.1	15.4	16.4	20.0
BZX84C24T	P9	24	22.8	25.6	5.0	70	250	1.0	0.1	16.8	18.4	22.0
BZX84C27T	PA	27	25.1	28.9	2.0	80	250	0.5	0.1	18.9	21.4	25.3
BZX84C30T	PB	30.0	28.0	32.0	2.0	80	300	0.5	0.1	21.0	24.4	29.4
BZX84C33T	PC	33.0	31.0	35.0	2.0	80	300	0.5	0.1	23.1	27.4	33.4
BZX84C36T	PD	36.0	34.0	38.0	2.0	90	325	0.5	0.1	25.2	30.4	37.4
BZX84C39T	PE	39.0	37.0	41.0	2.0	130	350	0.5	0.1	27.3	33.4	41.2

Notes: 5. Short duration pulse test used to minimize self-heating effect.
6. $f = 1\text{KHz}$.

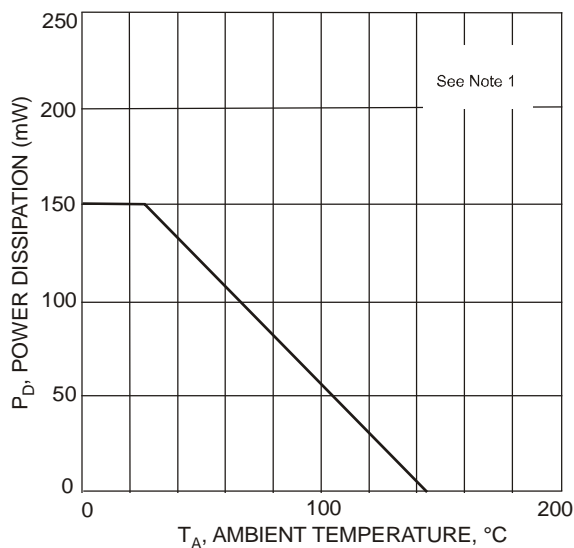

Fig. 1. Power Derating Curve

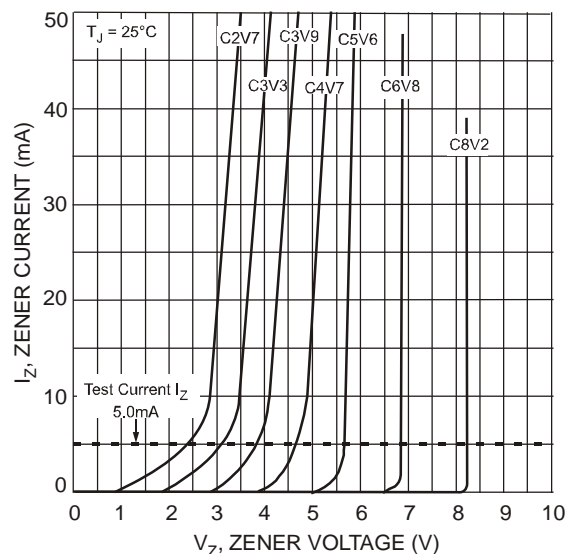

Fig. 2 Typical Zener Breakdown Characteristics

NEW PRODUCT

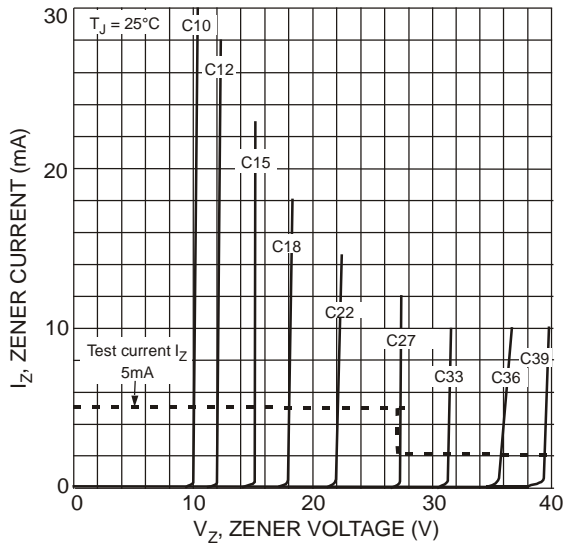

Fig. 3. Typical Zener Breakdown Characteristics

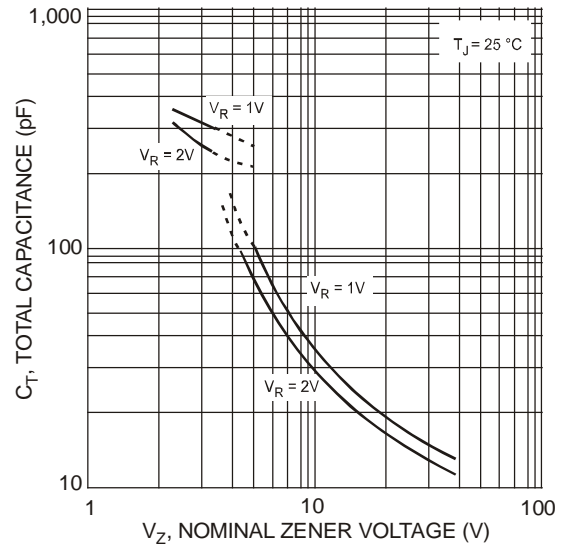

Fig. 4. Typical Total Capacitance vs. Nominal Zener Voltage

Ordering Information (Note 7)

Part Number	Case	Packaging
(Type Number)-7-F*	SOT-523	3000/Tape & Reel

*Add "-7-F" to the appropriate type number in Electrical Characteristics Table on page 2 example: 6.2V Zener = BZX84C6V2T-7-F.

Notes: 7. For packaging details, go to our website at <http://www.diodes.com/datasheets/ap02007.pdf>.

Marking Information

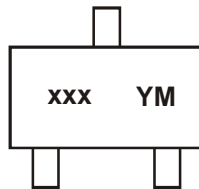

xxx = Product Type Marking Code
(See Electrical Characteristics Table)
YM = Date Code Marking
Y = Year (ex: N = 2002)
M = Month (ex: 9 = September)

Date Code Key

Year	2002	2003	2004	2005	2006	2007	2008	2009	2010	2111	2012
Code	N	P	R	S	T	U	V	W	X	Y	Z

Month	Jan	Feb	Mar	Apr	May	Jun	Jul	Aug	Sep	Oct	Nov	Dec
Code	1	2	3	4	5	6	7	8	9	O	N	D

Package Outline Dimensions

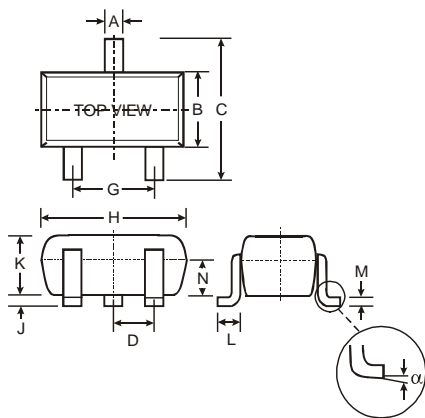

SOT-523			
Dim	Min	Max	Typ
A	0.15	0.30	0.22
B	0.75	0.85	0.80
C	1.45	1.75	1.60
D	—	—	0.50
G	0.90	1.10	1.00
H	1.50	1.70	1.60
J	0.00	0.10	0.05
K	0.60	0.80	0.75
L	0.10	0.30	0.22
M	0.10	0.20	0.12
N	0.45	0.65	0.50
α	0°	8°	—
All Dimensions in mm			

Suggested Pad Layout

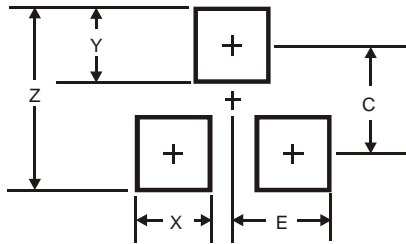

Dimensions	Value (in mm)
Z	1.8
X	0.4
Y	0.51
C	1.3
E	0.7

IMPORTANT NOTICE

Diodes Incorporated and its subsidiaries reserve the right to make modifications, enhancements, improvements, corrections or other changes without further notice to any product herein. Diodes Incorporated does not assume any liability arising out of the application or use of any product described herein; neither does it convey any license under its patent rights, nor the rights of others. The user of products in such applications shall assume all risks of such use and will agree to hold Diodes Incorporated and all the companies whose products are represented on our website, harmless against all damages.

LIFE SUPPORT

Diodes Incorporated products are not authorized for use as critical components in life support devices or systems without the expressed written approval of the President of Diodes Incorporated.

Mouser Electronics

Authorized Distributor

Click to View Pricing, Inventory, Delivery & Lifecycle Information:

Diodes Incorporated:

[BZX84C10T-7-F](#) [BZX84C11T-7-F](#) [BZX84C12T-7-F](#) [BZX84C13T-7-F](#) [BZX84C15T-7-F](#) [BZX84C16T-7-F](#)
[BZX84C22T-7-F](#) [BZX84C24T-7-F](#) [BZX84C27T-7-F](#) [BZX84C2V7T-7-F](#) [BZX84C30T-7-F](#) [BZX84C33T-7-F](#)
[BZX84C36T-7-F](#) [BZX84C39T-7-F](#) [BZX84C3V0T-7-F](#) [BZX84C3V3T-7-F](#) [BZX84C3V6T-7-F](#) [BZX84C3V9T-7-F](#)
[BZX84C4V7T-7-F](#) [BZX84C5V1T-7-F](#) [BZX84C6V2T-7-F](#) [BZX84C6V8T-7-F](#) [BZX84C7V5T-7-F](#) [BZX84C8V2T-7-F](#)
[BZX84C9V1T-7-F](#)