

DO NOT SCALE FROM THIS PRINT

SEAF-XX-XX.X-XX-XX-X-A-XX-K-TR

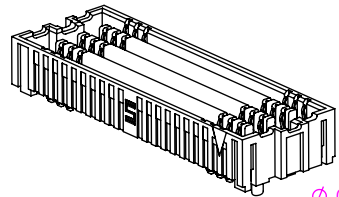
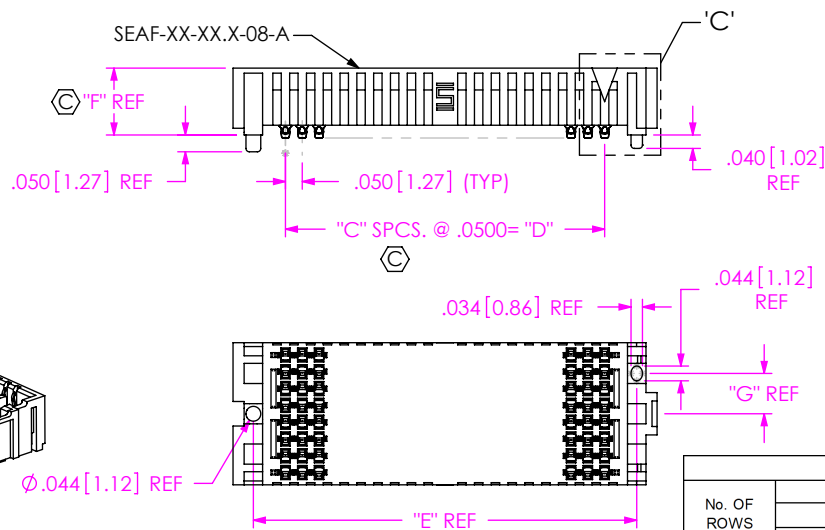
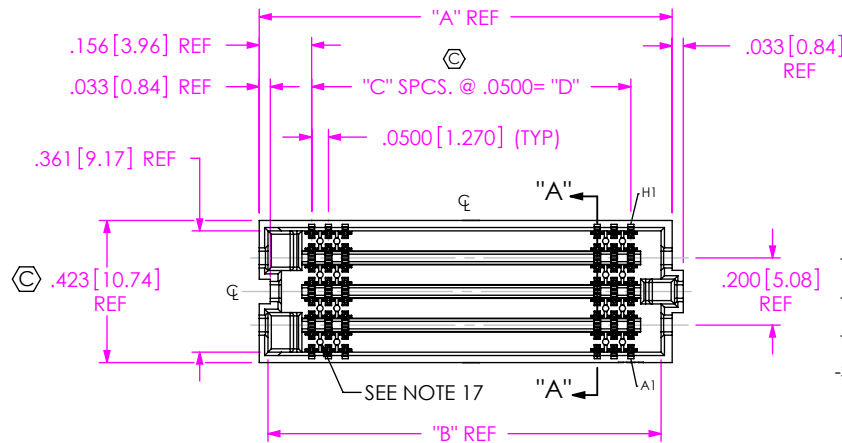

FIG 1
-08: 8 ROW
(SEAF-20-05.0-XX-08-1-A-XX-K-TR SHOWN)
(SOME CENTER FEATURES REMOVED FOR CLARITY)

No. OF POSITIONS

- -10, ☒ -15, ** -19, -20
- △ -25, -30, -40, -50 (PER ROW)

LEAD STYLE

- 05.0: .199 [5.05] HEIGHT
- 06.0: .238 [6.05] HEIGHT
- 06.5: .258 [6.55] HEIGHT
- 07.5: .297 [7.54] HEIGHT (SEE TABLE 1)

PLATING SPECIFICATION

- S: SELECTIVE GOLD (30µ") IN CONTACT AREA, MATTE TIN ON TAIL (USE NEW-SUB-C-209-XX.X-S-X)
- L: LIGHT GOLD (10µ") IN CONTACT AREA, MATTE TIN ON TAIL (USE NEW-SUB-C-209-XX.X-L-X)
- SM: SELECTIVE GOLD (30µ") IN CONTACT AREA, MATTE TIN ON TAIL (USE NEW-SUB-C-209-XX.X-S-X)
- STL: SELECTIVE GOLD (30µ") IN CONTACT AREA, MATTE TIN/LEAD ON TAIL (USE NEW-SUB-C-209-XX.X-STL-X)

ROWS

- 04: 4 ROWS (SEE SHT 5, FIG 11)
- 05: 5 ROWS (SEE SHT 3, FIG 5) (SEE NOTE 18)
- 06: 6 ROWS (SEE SHT 3, FIG 4)
- 08: 8 ROWS (SEE SHT 1, FIG 1)
- 10: 10 ROWS (SEE SHT 2, FIG 2)
- -14: 14 ROWS (SEE SHT 5, FIG 12)

- * = NOT TOOLED.
- = 10 POSITION ONLY AVAILABLE IN 4 ROW.
- ☒ = ONLY AVAILABLE WITH -05.0 BODY HEIGHT, -10 ROW. AVAILABLE IN -04 ROW -05.0 LEAD STYLE
- △ = ONLY AVAILABLE WITH -05.0, -06.5 & -07.5 BODY HEIGHT AND 4 ROW. TOOLED IN -07.5 (NOT ENGINEERING APPROVED)
- ** = ONLY AVAILABLE WITH -06.5 BODY HEIGHT, AND -06 ROW.
- **** = ONLY AVAILABLE WITH -05.0 BODY HEIGHT, -04, -06, -08 & -10 ROW.
- ***** = NOT RELEASED FOR PRODUCTION.
- = 14 ROW ONLY AVAILABLE IN -06.5 LEAD STYLE AND -40 POS.

TAPE & REEL

K-DOT
(SEE SHT 2, FIG 3)

OPTION

- ****-LP: LATCH POST OPTION (SEE SHT 4, FIG 8) (ONLY AVAILABLE WITH -05.0 LEAD STYLE, -04, -06, -08 & -10 ROW) (-K OPTION NOT AVAILABLE ON -10 OR -15 POSITION)
- *****-RP: RETENTION PIN (SEE SHT 4, FIG 9) (ONLY AVAILABLE WITH -05.0 LEAD STYLE, 6, 8 & 10 ROWS)
- PP: POLARIZATION PIN (SEE SHT 4, FIG 10) (ONLY AVAILABLE WITH -05.0 LEAD STYLE, 6, 8 & 10 ROWS)

ALIGNMENT PINS
(SEE NOTES 6 & 14)

SOLDER COMPOSITION & STYLE

- 1: 63% TIN / 37% LEAD
- CHARGE TAIL**
(USE NEW-SUB-C-209-XX.X-X-1)
- 2: 95.5% TIN/3.8% SILVER/.7% COPPER
- CHARGE TAIL**
(USE NEW-SUB-C-209-XX.X-X-2)

TABLE 2		
No Of ROWS	"G"	
-04	.079	[2.01]
-05	.120	[3.05]
-06	.120	[3.05]
-08	.120	[3.05]
-10	.120	[3.05]
-14	.120	[3.05]

TABLE 1					
No. Of ROWS	"F"				
	LEAD STYLE				
	-05.0	-06.0	-06.5	-07.5	
-04	.204 [5.18]	.243 [6.17]	.263 [6.68]	.302 [7.67]	
-05, -06, -08, -10, -14	.199 [5.05]	.238 [6.05]	.258 [6.55]	.297 [7.54]	

TABLE 3						
No Of POS.	"A"	"B"	"C"	"D"	"E"	
□ -10	.729 [18.52]	.670 [17.02]	9	.4500 [11.430]	.6410 [16.281]	
☒ -15	.979 [24.87]	.920 [23.37]	14	.7000 [17.780]	.8910 [22.631]	
** -19	1.179 [29.95]	1.120 [28.45]	18	.9000 [22.860]	1.0910 [27.711]	
-20	1.229 [31.22]	1.170 [29.72]	19	.9500 [24.130]	1.1410 [28.981]	
△ -25	1.479 [37.57]	1.420 [36.07]	24	1.2000 [30.480]	1.3910 [35.331]	
-30	1.729 [43.92]	1.670 [42.42]	29	1.4500 [36.830]	1.6410 [41.681]	
-40	2.229 [56.62]	2.170 [55.12]	39	1.9500 [49.530]	2.1410 [54.381]	
-50	2.729 [69.32]	2.670 [67.82]	49	2.4500 [62.230]	2.6410 [67.081]	

TABLE 4		
LEAD STYLE	BODY CALLOUT	CONTACT
		SOLDER CHARGE TAIL
-05.0	SEAF-XX-05.0-XX-X	NEW-SUB-C-209-05.0-X-X
-06.0	SEAF-XX-06.0-XX-X	NEW-SUB-C-209-06.0-X-X
-06.5	SEAF-XX-06.5-XX-X	NEW-SUB-C-209-06.5-X-X
-07.5	SEAF-XX-07.5-XX-X	NEW-SUB-C-209-07.5-X-X

TABLE 5									
STACK HEIGHT									
SEAF LEAD STYLE	SEAM LEAD STYLE								
	-02.0	-03.0	-03.5	-06.5	-07.0	-09.0	-11.0	* -13.0	
-05.0	7mm	8mm	8.5mm	11.5mm	12mm	14mm	16mm	18mm	
-06.0	8mm	9mm	9.5mm	12.5mm	13mm	15mm	17mm	19mm	
-06.5	8.5mm	9.5mm	10mm	13mm	13.5mm	15.5mm	17.5mm	19.5mm	
-07.5	9.5mm	10.5mm	11mm	14mm	14.5mm	16.5mm	18.5mm	20.5mm	

NOTES:

1. Ⓞ REPRESENTS A CRITICAL DIMENSION.
2. MINIMUM PUSHOUT FORCE: 0.50 LBS.
3. NOTE DELETED.
4. 5 ROW SOLDER TAILS ARE NOT SYMMETRICAL WITH BODY WIDTH - DIM .321 [8.15]. (SEE SHEET 3, FIG. 5).
5. WHEN APPLICABLE, DIMENSION C12 MUST BE MEASURED USING INSPECTION FIXTURE AT-1817-836-1 FOR -04 ROW, OR AT-1817-836-2 FOR -06, -08 & -10 ROW. USE CO-AU-WI-2003-M FOR PROCESS.
6. WITHOUT -A, AVAILABLE FOR EXISTING CUSTOMERS ONLY AS OF REVISION Y.
7. NOTE DELETED.
8. NOTE DELETED.
9. FOR QUANTITIES UP TO 49 PIECES, NO LEADER, TRAILER, OR REEL WILL BE SUPPLIED. FOR QUANTITIES OF 50 - 124 PIECES, NO LEADER OR TRAILER WILL BE SUPPLIED. SPLICES MAY BE PRESENT.
10. ATTACH LABEL "SEAX-0001" TO EACH TAPE & REEL PACKAGE.
11. SOLDER CHARGE VOLUME IS .00000891 CUBIC INCHES (REF).
12. NOTE DELETED.
13. SLOT ORIENTATION MUST BE AS SHOWN.
14. A-PINS STANDARD ON ALL BODIES, EXCEPT 6 x 19. SEE SHEET 1, FIG. 1
15. A-PINS ARE OPTIONAL ON 6 x 19, SEE SHEET 4, FIG. 7
16. MEASURED FIRST & LAST POSITIONS ONLY, ALL ROWS.
17. NOTE DELETED.
18. NON-FUNCTIONAL VOIDING IN PLASTIC BODY TO BE AT SAMTEC'S DISCRETION.
19. THESE OPTIONS AVAILABLE AS ASO (APPLICATION SPECIFIC OPTIONS) ONLY. PLEASE CONTACT SAMTEC FOR MORE INFORMATION.

UNLESS OTHERWISE SPECIFIED, DIMENSIONS ARE IN INCHES.

TOLERANCES ARE:

- DECIMALS
- ANGLES
- .XX: ±.01[0.3]
- .XXX: ±.005[0.13]
- .XXXX: ±.0020[0.051]

PROPRIETARY NOTE

THIS DOCUMENT CONTAINS CONFIDENTIAL AND PROPRIETARY INFORMATION AND ALL DESIGN, MANUFACTURING, REPRODUCTION, USE, PATENT RIGHTS AND SALES RIGHTS ARE EXPRESSLY RESERVED BY SAMTEC, INC. THIS DOCUMENT SHALL NOT BE DISCLOSED, IN WHOLE OR PART, TO ANY UNAUTHORIZED PERSON OR ENTITY NOR REPRODUCED, TRANSFERRED OR INCORPORATED IN ANY OTHER PROJECT IN ANY MANNER WITHOUT THE EXPRESS WRITTEN CONSENT OF SAMTEC, INC.

MATERIAL: DO NOT SCALE DRAWING
INSULATOR: LCP, COLOR: BLACK
CONTACT: COPPER ALLOY

SHEET SCALE: 2:1

DESCRIPTION:

.050 PITCH SOCKET ARRAY ASSEMBLY

DWG. NO.

SEAF-XX-XX.X-XX-XX-X-A-XX-K-TR

BY: BRATCHER 05/27/2004

SHEET 1 OF 5

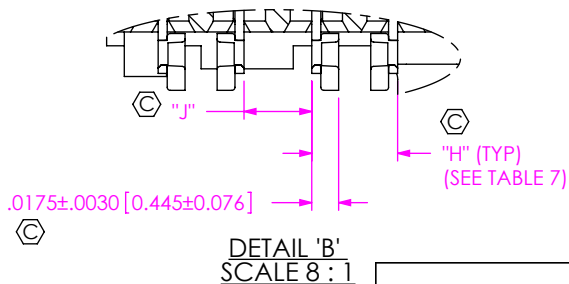
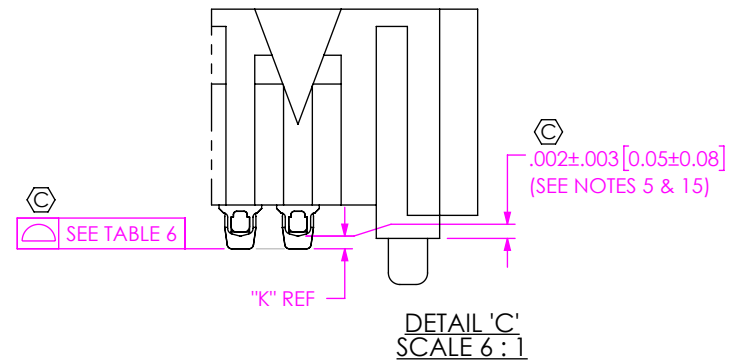
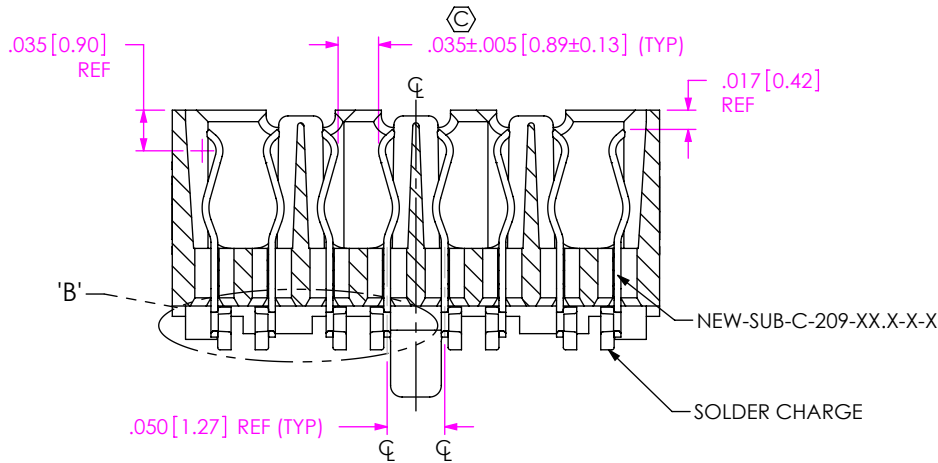

SECTION "A"- "A"
SCALE 6 : 1

POSITION	COPLANARITY
-10 TO -30	.006 [0.15]
-40	.009 [0.23]
-50	.009 [0.23]

LEAD STYLE	"H"	"J"	"K"
-05.0	.0530 - .0590 [1.346] - [1.499]	.0410 - .0470 [1.041] - [1.194]	.011 [0.28]
-06.0	.0530 - .0620 [1.346] - [1.575]	.0380 - .0470 [.965] - [1.194]	.011 [0.28]
-06.5	.0530 - .0645 [1.346] - [1.638]	.0355 - .0470 [.902] - [1.194]	.011 [0.28]
-07.5	.0530 - .0645 [1.346] - [1.638]	.0355 - .0470 [.902] - [1.194]	.011 [0.28]

FIG 2
-10: 10 ROW
(SAME AS FIG 1, EXCEPT AS SHOWN)
(SEAF-20-05.0-XX-10-1-A-XX-K-TR SHOWN)
(SOME CENTER FEATURES REMOVED FOR CLARITY)

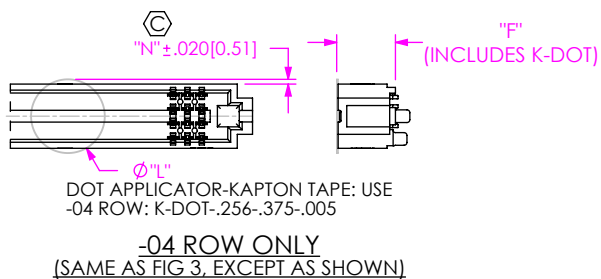
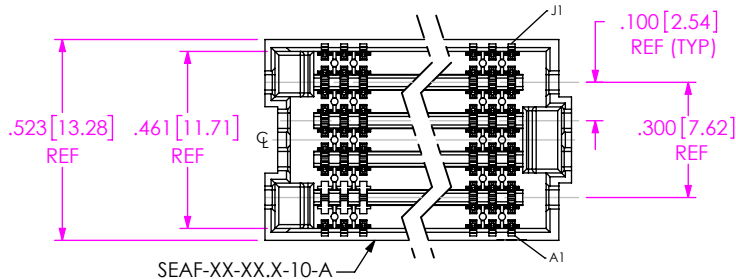

ROWS	"L"	"M"										"N"
		□10 POS	⊠15 POS	**19 POS	20 POS	△25 POS	30 POS	40 POS	50 POS			
-04	.256 [6.50]	.254 [6.44]	.379 [9.62]	.479 [12.16]	.504 [12.79]	.629 [15.97]	.754 [19.14]	1.004 [25.49]	1.254 [31.84]	.017 [.43]		
-05, -06	.256 [6.50]	.254 [6.44]	.379 [9.62]	.479 [12.16]	.504 [12.79]	.629 [15.97]	.754 [19.14]	1.004 [25.49]	1.254 [31.84]	.034 [.86]		
-08	.325 [8.25]	.219 [5.57]	.344 [8.74]	.444 [11.28]	.469 [11.92]	.594 [15.09]	.719 [18.27]	.969 [24.62]	1.219 [30.97]	.049 [1.24]		
-10	.404 [10.25]	.180 [4.57]	.305 [7.74]	.405 [10.28]	.430 [10.92]	.555 [14.09]	.680 [17.27]	.930 [23.62]	1.180 [29.97]	.060 [1.52]		
-14	.404 [10.25]	N/A	N/A	N/A	N/A	N/A	N/A	.930 [23.62]	N/A	.160 [4.05]		

FIG 3
-K: POLYIMIDE PAD
(SEAF-20-05.0-XX-08-1-A-XX-K-TR SHOWN)
(SAME AS FIG. 1, EXCEPT AS SHOWN)
(SOME CENTER FEATURES REMOVED FOR CLARITY)

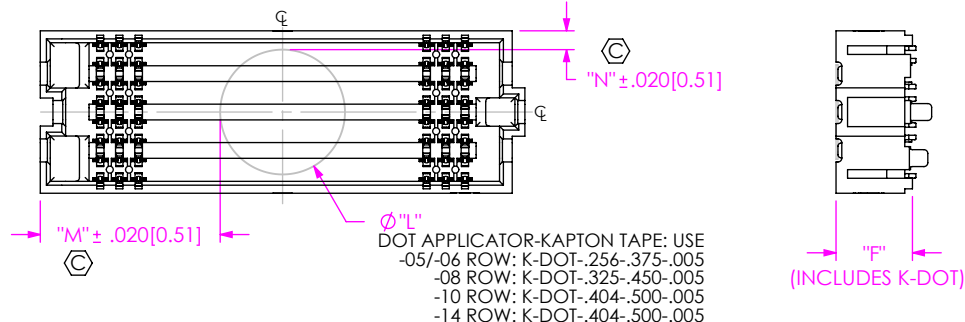

<p>PROPRIETARY NOTE</p> <p>THIS DOCUMENT CONTAINS CONFIDENTIAL AND PROPRIETARY INFORMATION AND ALL DESIGN, MANUFACTURING, REPRODUCTION, USE, PATENT RIGHTS AND SALES RIGHTS ARE EXPRESSLY RESERVED BY SAMTEC, INC. THIS DOCUMENT SHALL NOT BE DISCLOSED, IN WHOLE OR PART, TO ANY UNAUTHORIZED PERSON OR ENTITY NOR REPRODUCED, TRANSFERRED OR INCORPORATED IN ANY OTHER PROJECT IN ANY MANNER WITHOUT THE EXPRESS WRITTEN CONSENT OF SAMTEC, INC.</p> <p>DO NOT SCALE DRAWING</p> <p>SHEET SCALE: 2:1</p>	<p>520 PARK EAST BLVD. NEW ALBANY, IN 47150 PHONE: 812-944-6733 FAX: 812-948-5047 e-Mail info@SAMTEC.com code 55322</p>	
		DESCRIPTION:
		DWG. NO.
		BY: BRATCHER 05/27/2004 SHEET 2 OF 5

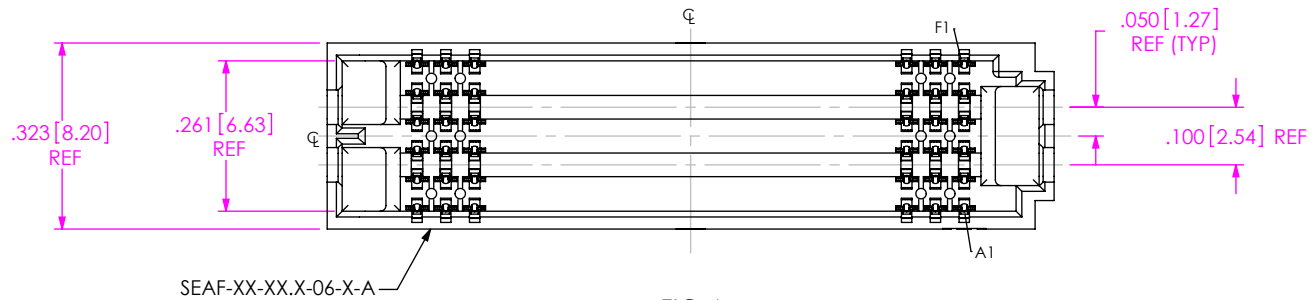
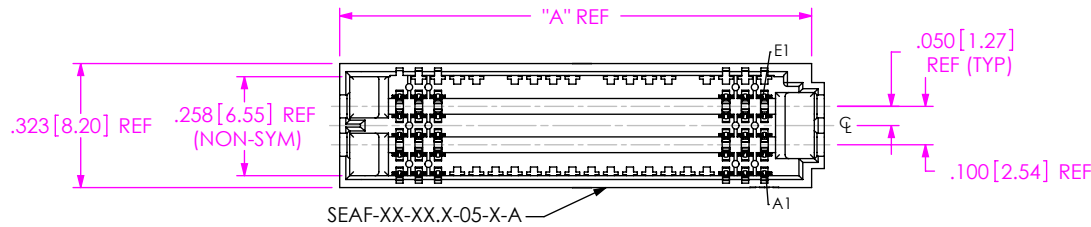

FIG 4
 -06: 6 ROW
 (SAME AS FIG 1, EXCEPT AS SHOWN)
 (SEAF-20-05.0-XX-06-1-A-XX-K-TR SHOWN)
 (SOME CENTER FEATURES REMOVED FOR CLARITY)



SEAF-XX-XX.X-05-X-A

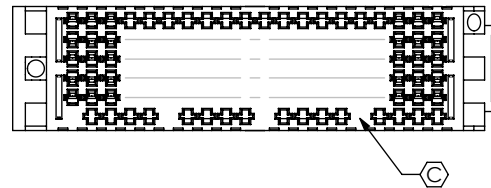
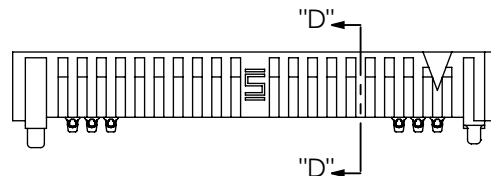
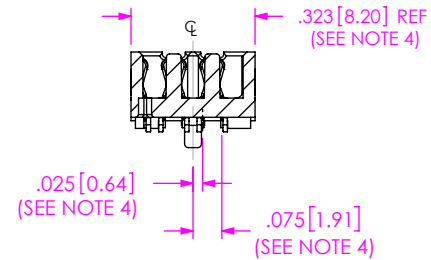

FIG 5
 -05: 5 ROW
 (SAME AS FIG 4, EXCEPT AS SHOWN)
 (SEAF-20-05.0-XX-05-1-A-XX-K-TR SHOWN)
 (SOME CENTER FEATURES REMOVED FOR CLARITY)



SECTION "D"-"D"

PROPRIETARY NOTE
 THIS DOCUMENT CONTAINS CONFIDENTIAL AND PROPRIETARY INFORMATION AND ALL DESIGN, MANUFACTURING, REPRODUCTION, USE, PATENT RIGHTS AND SALES RIGHTS ARE EXPRESSLY RESERVED BY SAMTEC, INC. THIS DOCUMENT SHALL NOT BE DISCLOSED, IN WHOLE OR PART, TO ANY UNAUTHORIZED PERSON OR ENTITY NOR REPRODUCED, TRANSFERRED OR INCORPORATED IN ANY OTHER PROJECT IN ANY MANNER WITHOUT THE EXPRESS WRITTEN CONSENT OF SAMTEC, INC.

DO NOT SCALE DRAWING

SHEET SCALE: 1:0.333333



520 PARK EAST BLVD, NEW ALBANY, IN 47150
 PHONE: 812-944-6733 FAX: 812-948-5047
 e-Mail info@SAMTEC.com code 55322

DESCRIPTION:
 .050 PITCH SOCKET ARRAY ASSEMBLY
 DWG. NO.
 SEAF-XX-XX.X-XX-XX-X-A-XX-K-TR
 BY: BRATCHER 05/27/2004 SHEET 3 OF 5

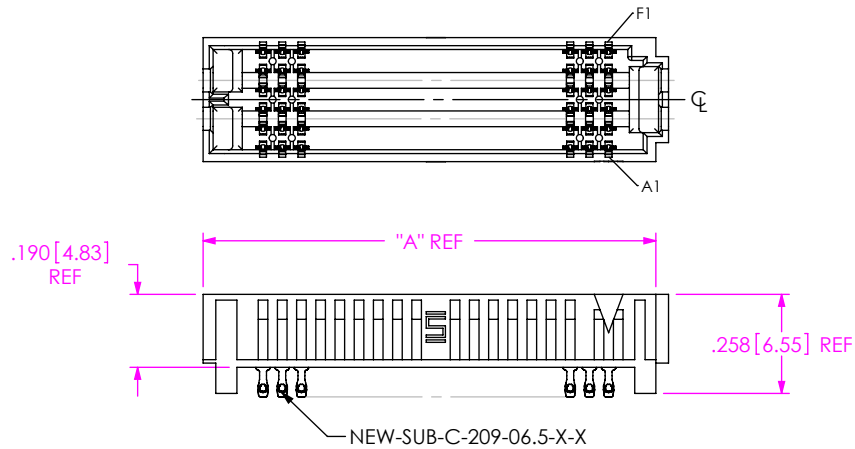

FIG 7
06 ROW x 19 POS
(ONLY AVAILABLE -06.5 LEADSTYLE & -06 ROW)
(SEAF-20-06.5-XX-06-1-XX-K-TR SHOWN)
(SAME AS FIGS 1 & 4 EXCEPT AS SHOWN)
(SOME CENTER FEATURES REMOVED FOR CLARITY)

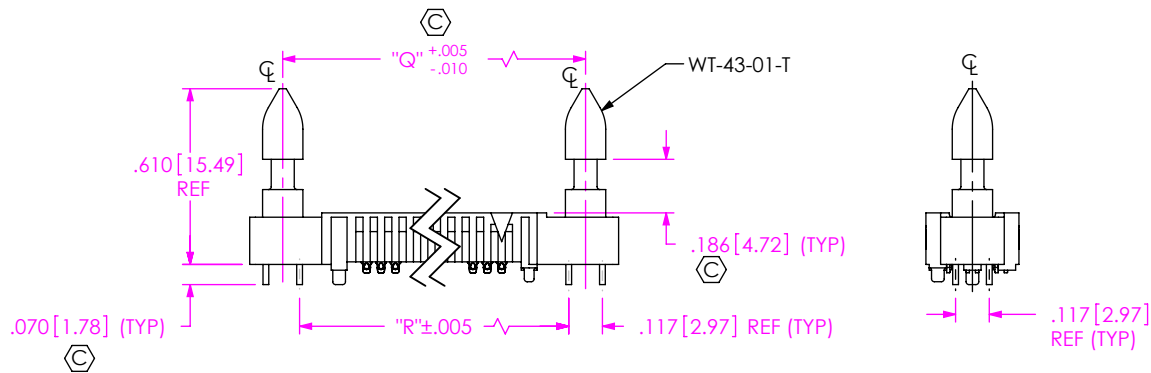
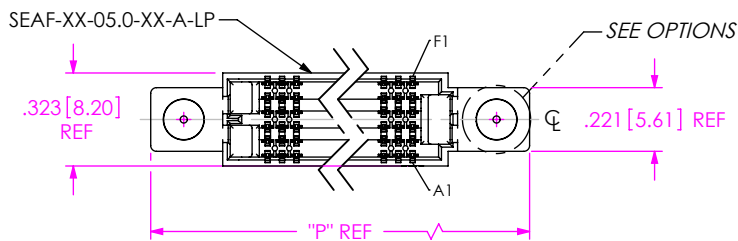

FIG 8
-LP OPTION
(SEAF-20-05.0-XX-06-1-A-LP-K-TR SHOWN)
(SOME CENTER FEATURES REMOVED FOR CLARITY)
(SAME AS FIG 1 EXCEPT AS SHOWN)
(-LP OPTION REQUIRED FOR SEAC MATE ONLY)
(ONLY AVAILABLE WITH -05.0 LEAD STYLE -04, -06, -08 & -10 ROW)

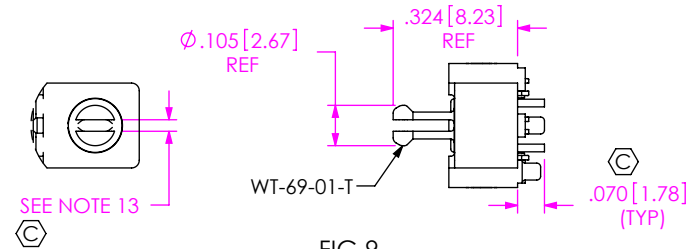

FIG 9
****-RP OPTION
(SEAF-20-05.0-XX-06-1-A-RP-K-TR SHOWN)
(SOME CENTER FEATURES REMOVED FOR CLARITY)
(SAME AS FIG 7 EXCEPT AS SHOWN)
(-RP OPTION VALID FOR SEAR MATE ONLY)
(ONLY AVAILABLE WITH -05.0 LEAD STYLE 6, 8 & 10 ROW)

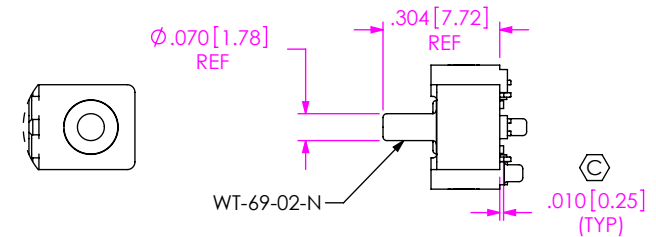

FIG 10
-PP OPTION
(SEAF-20-05.0-XX-06-1-A-PP-K-TR SHOWN)
(SOME CENTER FEATURES REMOVED FOR CLARITY)
(SAME AS FIG 8 EXCEPT AS SHOWN)
(-PP OPTION VALID FOR SEAR MATE ONLY)
(ONLY AVAILABLE WITH -05.0 LEAD STYLE 6, 8 & 10 ROW)

TABLE 9

No OF POS.	"P"	"Q"	"R"
□ -10	1.262 [32.05]	1.033 [26.24]	.9160 [23.266]
⊠ -15	1.512 [38.40]	1.283 [32.59]	1.1660 [29.616]
** -19	1.712 [43.48]	1.483 [37.67]	1.3660 [34.696]
-20	1.762 [44.75]	1.533 [38.94]	1.4160 [35.966]
△ -25	2.012 [51.10]	1.783 [45.29]	1.6660 [42.316]
-30	2.262 [57.45]	2.033 [51.64]	1.9160 [48.666]
-40	2.762 [70.15]	2.533 [64.34]	2.4160 [61.366]
-50	3.262 [82.85]	3.033 [77.04]	2.9160 [74.066]

PROPRIETARY NOTE
THIS DOCUMENT CONTAINS CONFIDENTIAL AND PROPRIETARY INFORMATION AND ALL DESIGN, MANUFACTURING, REPRODUCTION, USE, PATENT RIGHTS AND SALES RIGHTS ARE EXPRESSLY RESERVED BY SAMTEC, INC. THIS DOCUMENT SHALL NOT BE DISCLOSED, IN WHOLE OR PART, TO ANY UNAUTHORIZED PERSON OR ENTITY NOR REPRODUCED, TRANSFERRED OR INCORPORATED IN ANY OTHER PROJECT IN ANY MANNER WITHOUT THE EXPRESS WRITTEN CONSENT OF SAMTEC, INC.

DO NOT SCALE DRAWING
SHEET SCALE: 1:0.333333



520 PARK EAST BLVD. NEW ALBANY, IN 47150
PHONE: 812-944-6733 FAX: 812-948-5047
e-Mail info@SAMTEC.com code 55322

DESCRIPTION:
.050 PITCH SOCKET ARRAY ASSEMBLY
DWG. NO.
SEAF-XX-XX.X-XX-XX-X-A-XX-K-TR
BY: BRATCHER 05/27/2004 SHEET 4 OF 5

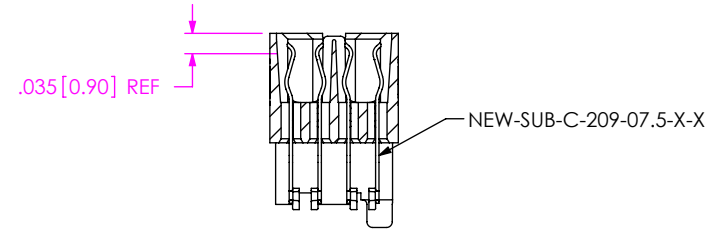
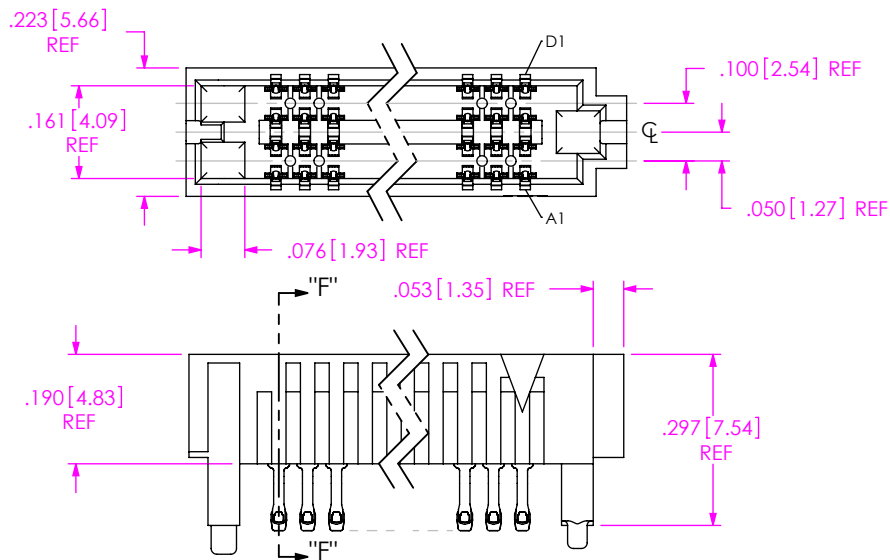

FIG 11
 -04: 4 ROW
 (SEAF-30-07.5-XX-04-1-A-XX-K-TR SHOWN)
 (SOME CENTER FEATURES REMOVED FOR CLARITY)
 (SAME AS FIG 1 EXCEPT AS SHOWN)

SECTION "F"- "F"

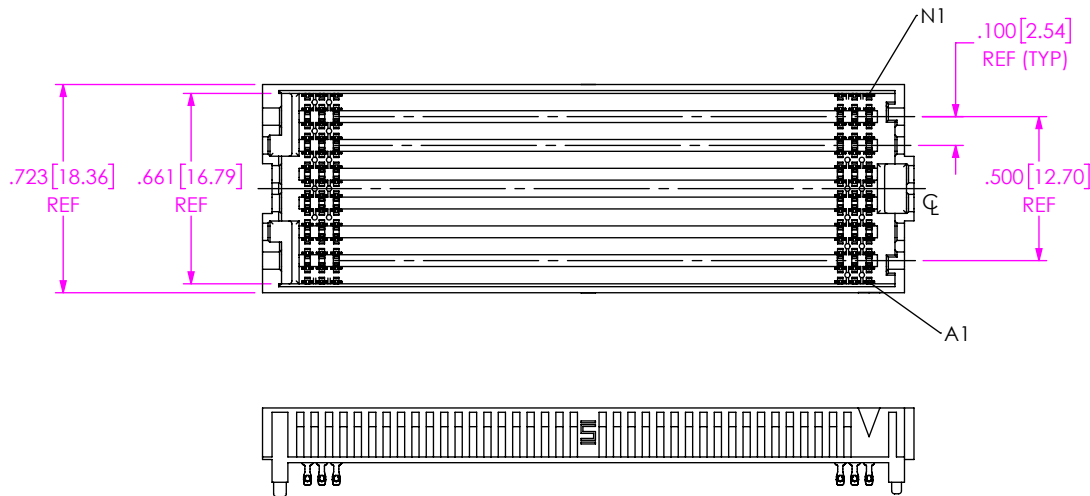

FIG 12
 -14: 14 ROW
 (SEAF-40-06.5-XX-14-1-A-XX-K-TR SHOWN)
 (SOME CENTER FEATURES REMOVED FOR CLARITY)
 (SAME AS FIG 1 EXCEPT AS SHOWN)

PROPRIETARY NOTE
 THIS DOCUMENT CONTAINS CONFIDENTIAL AND PROPRIETARY INFORMATION AND ALL DESIGN, MANUFACTURING, REPRODUCTION, USE, PATENT RIGHTS AND SALES RIGHTS ARE EXPRESSLY RESERVED BY SAMTEC, INC. THIS DOCUMENT SHALL NOT BE DISCLOSED, IN WHOLE OR PART, TO ANY UNAUTHORIZED PERSON OR ENTITY NOR REPRODUCED, TRANSFERRED OR INCORPORATED IN ANY OTHER PROJECT IN ANY MANNER WITHOUT THE EXPRESS WRITTEN CONSENT OF SAMTEC, INC.

DO NOT SCALE DRAWING

SHEET SCALE: 1:0.333333



520 PARK EAST BLVD, NEW ALBANY, IN 47150
 PHONE: 812-944-6733 FAX: 812-948-5047
 e-Mail info@SAMTEC.com code 55322

DESCRIPTION:
 .050 PITCH SOCKET ARRAY ASSEMBLY

DWG. NO.
 SEAF-XX-XX.X-XX-XX-X-A-XX-K-TR

BY: BRATCHER 05/27/2004 SHEET 5 OF 5