

THIS DOCUMENT IS THE PROPERTY OF
KEYSTONE ELECTRONICS CORP. AND
SHALL NOT BE REPRODUCED, DISTRIBUTED
OR USED AS A BASIS FOR MANUFACTURE
WITHOUT PRIOR WRITTEN PERMISSION
FROM KEYSTONE ELECTRONICS CORP.

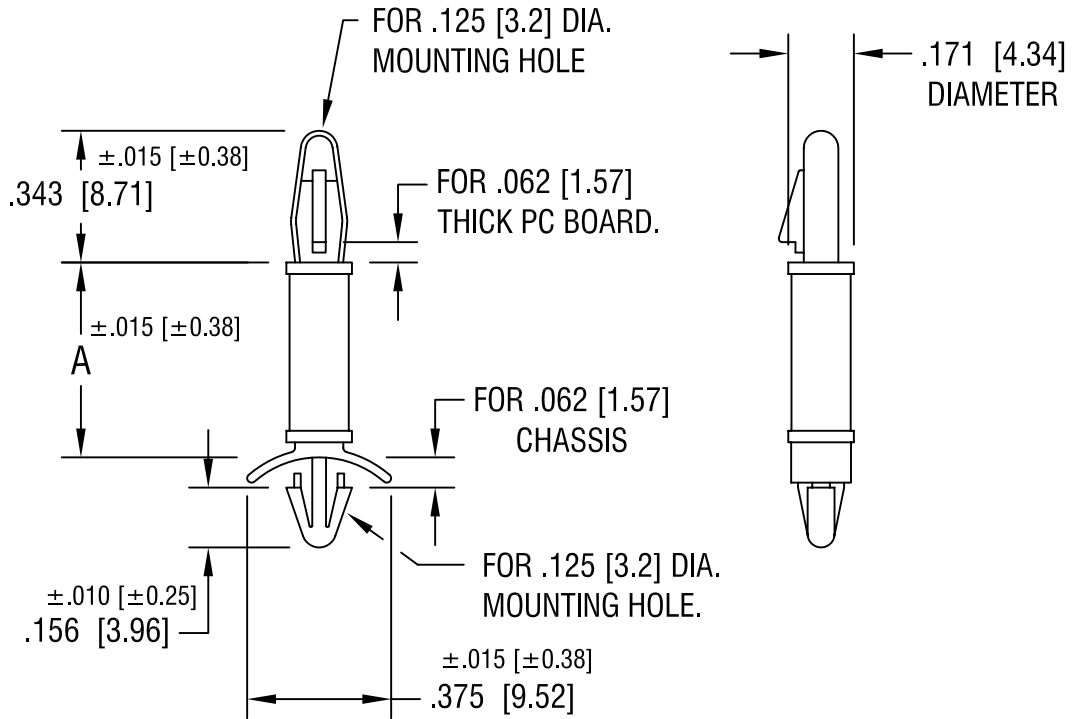

PART NO.	'A' DIM.
8871	.187 [4.74]
8872	.250 [6.35]
8873	.375 [9.52]
8874	.500 [12.70]
8875	.625 [15.87]

KEYSTONE ELECTRONICS CORP.

ASTORIA, N.Y. 11105-2017

PART NAME

PC LOCK-IN SUPPORT

MATERIAL

NYLON UL 94V-0

FINISH

-

DRN BY

BOONE

DATE

8.29.06

APP'D

LN

SCALE

2X

TOLERANCES

INCH

[MM]

CODE

DWG NO.

DECIMAL $\pm .005 [\pm 0.15]$

ANGULAR $\pm 1^\circ$
UNLESS OTHERWISE SPECIFIED

C/M

8871-8875

DATE

DESCRIPTION

REV.

Mouser Electronics

Authorized Distributor

Click to View Pricing, Inventory, Delivery & Lifecycle Information:

[Keystone Electronics:](#)

[8874](#)