

TPS2832, TPS2833 FAST SYNCHRONOUS-BUCK MOSFET DRIVERS WITH DEAD-TIME CONTROL

SLVS195C – FEBRUARY 1999 – REVISED JANUARY 2001

- Floating Bootstrap or Ground-Reference High-Side Driver
- Adaptive Dead-Time Control
- 50-ns Max Rise/Fall Times and 100-ns Max Propagation Delay – 3.3-nF Load
- Ideal for High-Current Single or Multiphase Power Supplies
- 2.4-A Typical Peak Output Current
- 4.5-V to 15-V Supply Voltage Range
- Internal Schottky Bootstrap Diode
- Low Supply Current...3-mA Typical
- –40°C to 125°C Operating Virtual Junction Temperature
- Available in SOIC Package

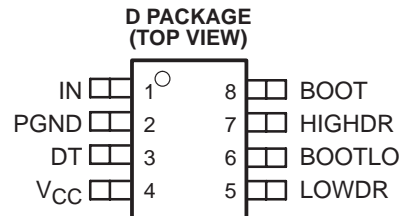

description

The TPS2832 and TPS2833 are MOSFET drivers for synchronous-buck power stages. These devices are ideal for designing a high-performance power supply using switching controllers that do not have MOSFET drivers. The drivers are designed to deliver 2.4-A peak currents into large capacitive loads. The high-side driver can be configured as a ground-reference driver or as a floating bootstrap driver. An adaptive dead-time control circuit eliminates shoot-through currents through the main power FETs during switching transitions and provides high efficiency for the buck regulator.

The TPS2832 has a noninverting input. The TPS2833 has an inverting input. The TPS2832/33 drivers, available in 8-terminal SOIC packages, operate over a junction temperature range of –40°C to 125°C.

AVAILABLE OPTIONS

T_J	PACKAGED DEVICES
	SOIC (D)
–40°C to 125°C	TPS2832D TPS2833D

The D package is available taped and reeled. Add R suffix to device type (e.g., TPS2832DR)

Related Synchronous MOSFET Drivers

DEVICE NAME	ADDITIONAL FEATURES	INPUTS	
TPS2830	ENABLE, SYNC and CROWBAR	CMOS	Noninverted
TPS2831			Inverted
TPS2834	ENABLE, SYNC and CROWBAR	TTL	Noninverted
TPS2835			Inverted
TPS2836	W/O ENABLE, SYNC and CROWBAR	TTL	Noninverted
TPS2837			Inverted



Please be aware that an important notice concerning availability, standard warranty, and use in critical applications of Texas Instruments semiconductor products and disclaimers thereto appears at the end of this data sheet.

PRODUCTION DATA information is current as of publication date. Products conform to specifications per the terms of Texas Instruments standard warranty. Production processing does not necessarily include testing of all parameters.



POST OFFICE BOX 655303 • DALLAS, TEXAS 75265

Copyright © 2001, Texas Instruments Incorporated

TPS2832, TPS2833 FAST SYNCHRONOUS-BUCK MOSFET DRIVERS WITH DEAD-TIME CONTROL

SLVS195C – FEBRUARY 1999 – REVISED JANUARY 2001

functional block diagram

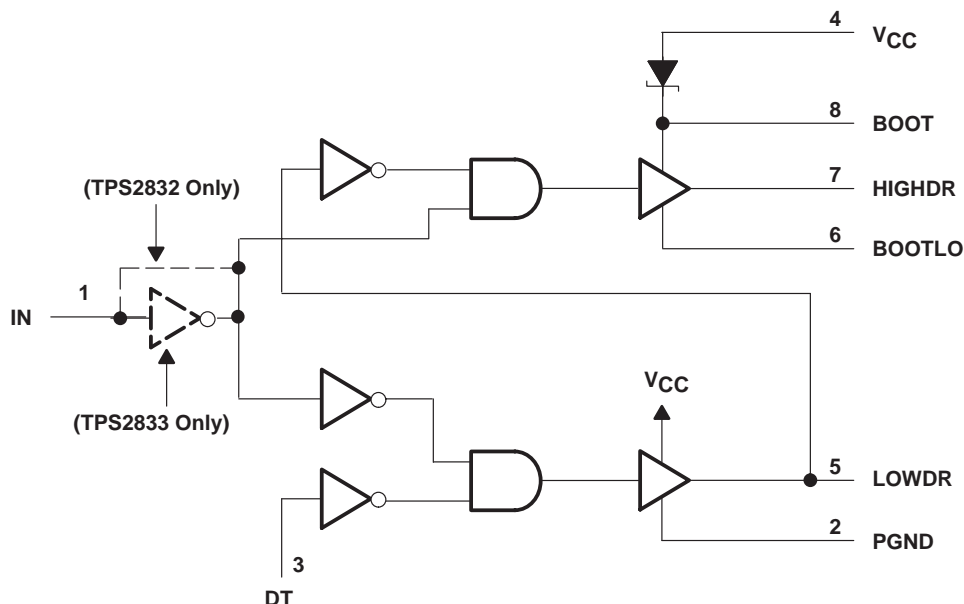

Terminal Functions

TERMINAL NAME	NO.	I/O	DESCRIPTION
BOOT	8	I	Bootstrap terminal. A ceramic capacitor is connected between BOOT and BOOTLO terminals to develop the floating bootstrap voltage for the high-side MOSFET. The capacitor value is typically between 0.1 μ F and 1 μ F. A 1-M Ω resistor should be connected across the bootstrap capacitor to provide a discharge path when the driver has been powered down.
BOOTLO	6	O	This terminal connects to the junction of the high-side and low-side MOSFETs.
DT	3	I	Dead-time control terminal. Connect DT to the junction of the high-side and low-side MOSFETs
HIGHDR	7	O	Output drive for the high-side power MOSFET
IN	1	I	Input signal to the MOSFET drivers (noninverting input for the TPS2832; inverting input for the TPS2833).
LOWDR	5	O	Output drive for the low-side power MOSFET
PGND	2		Power ground. Connect to the FET power ground.
VCC	4	I	Input supply. Recommended that a 1 μ F capacitor be connected from VCC to PGND.

detailed description

low-side driver

The low-side driver is designed to drive low $R_{ds(on)}$ N-channel MOSFETs. The current rating of the driver is 2 A, source and sink.

high-side driver

The high-side driver is designed to drive low $R_{ds(on)}$ N-channel MOSFETs. The current rating of the driver is 2 A, source and sink. The high-side driver can be configured as a ground-reference driver or a floating bootstrap driver. The internal bootstrap diode, is a Schottky for improved drive efficiency. The maximum voltage that can be applied between the BOOT terminal and ground is 30 V.

dead-time (DT) control†

Dead-time control prevents shoot through current from flowing through the main power FETs during switching transitions by controlling the turn-on times of the MOSFET drivers. The high-side driver is not allowed to turn on until the gate drive voltage to the low-side FET is low, and the low-side driver is not allowed to turn on until the voltage at the junction of the power FETs (V_{drain}) is low; the DT terminal connects to the junction of the power FETs.

IN†

The IN terminal is a digital terminal that is the input control signal for the drivers. The TPS2832 has a noninverting input; the TPS2833 has an inverting input.

†High-level input voltages on IN and DT must be greater than or equal to $0.7V_{CC}$.

TPS2832, TPS2833 FAST SYNCHRONOUS-BUCK MOSFET DRIVERS WITH DEAD-TIME CONTROL

SLVS195C – FEBRUARY 1999 – REVISED JANUARY 2001

absolute maximum ratings over operating free-air temperature (unless otherwise noted)†

Supply voltage range, V_{CC} (see Note 1)	–0.3 V to 16 V
Input voltage range: BOOT to PGND (high-side driver ON)	–0.3 V to 30 V
BOOTLO to PGND	–0.3 V to 16 V
BOOT to BOOTLO	–0.3 V to 16 V
IN (see Note 2)	–0.3 V to 16 V
DT (see Note 2)	–0.3 V to 30 V
Continuous total power dissipation	See Dissipation Rating Table
Operating virtual junction temperature range, T_J	–40°C to 125°C
Storage temperature range, T_{stg}	–65°C to 150°C
Lead temperature soldering 1,6 mm (1/16 inch) from case for 10 seconds	260°C

† Stresses beyond those listed under “absolute maximum ratings” may cause permanent damage to the device. These are stress ratings only, and functional operation of the device at these or any other conditions beyond those indicated under “recommended operating conditions” is not implied. Exposure to absolute-maximum-rated conditions for extended periods may affect device reliability.

- NOTES: 1. Unless otherwise specified, all voltages are with respect to PGND.
2. High-level input voltages on the IN and DT terminals must be less than or equal to V_{CC} .

DISSIPATION RATING TABLE

PACKAGE	$T_A \leq 25^\circ\text{C}$ POWER RATING	DERATING FACTOR ABOVE $T_A = 25^\circ\text{C}$	$T_A = 70^\circ\text{C}$ POWER RATING	$T_A = 85^\circ\text{C}$ POWER RATING
D	600 mW	6.0 mW/°C	330 mW	240 mW

recommended operating conditions

	MIN	NOM	MAX	UNIT
Supply voltage, V_{CC}	4.5		15	V
Input voltage	4.5		28	V

electrical characteristics over recommended operating virtual junction temperature range, $V_{CC} = 6.5\text{ V}$, $C_L = 3.3\text{ nF}$ (unless otherwise noted)

supply current

PARAMETER		TEST CONDITIONS		MIN	TYP	MAX	UNIT
V_{CC}	Supply voltage range			4.5		15	V
	Quiescent current	$V_{CC} = 15\text{ V}$				100	μA
		$V_{CC} = 12\text{ V}$, $f_{SWX} = 200\text{ kHz}$, $C_{HIGHDR} = 50\text{ pF}$,	BOOTLO grounded, $C_{LOWDR} = 50\text{ pF}$, See Note 3			3	mA

NOTE 3: Ensured by design, not production tested.



TPS2832, TPS2833
FAST SYNCHRONOUS-BUCK MOSFET DRIVERS
WITH DEAD-TIME CONTROL

SLVS195C – FEBRUARY 1999 – REVISED JANUARY 2001

electrical characteristics over recommended operating virtual junction temperature range,
 $V_{CC} = 6.5\text{ V}$, $C_L = 3.3\text{ nF}$ (unless otherwise noted) (continued)

output drivers

PARAMETER			TEST CONDITIONS	MIN	TYP	MAX	UNIT	
Peak output-current	High-side sink (see Note 4)	Duty cycle < 2%, $t_{pw} < 100\ \mu\text{s}$ (see Note 3)	$V_{BOOT} - V_{BOOTLO} = 4.5\text{ V}$, $V_{HIGHDR} = 4\text{ V}$	0.7	1.1		A	
			$V_{BOOT} - V_{BOOTLO} = 6.5\text{ V}$, $V_{HIGHDR} = 5\text{ V}$	1.1	1.5			
			$V_{BOOT} - V_{BOOTLO} = 12\text{ V}$, $V_{HIGHDR} = 10.5\text{ V}$	2	2.4			
	High-side source (see Note 4)	Duty cycle < 2%, $t_{pw} < 100\ \mu\text{s}$ (see Note 3)	$V_{BOOT} - V_{BOOTLO} = 4.5\text{ V}$, $V_{HIGHDR} = 0.5\text{ V}$	1.2	1.4		A	
			$V_{BOOT} - V_{BOOTLO} = 6.5\text{ V}$, $V_{HIGHDR} = 1.5\text{ V}$	1.3	1.6			
			$V_{BOOT} - V_{BOOTLO} = 12\text{ V}$, $V_{HIGHDR} = 1.5\text{ V}$	2.3	2.7			
	Low-side sink (see Note 4)	Duty cycle < 2%, $t_{pw} < 100\ \mu\text{s}$ (see Note 3)	$V_{CC} = 4.5\text{ V}$, $V_{LOWDR} = 4\text{ V}$	1.3	1.8		A	
			$V_{CC} = 6.5\text{ V}$, $V_{LOWDR} = 5\text{ V}$	2	2.5			
			$V_{CC} = 12\text{ V}$, $V_{LOWDR} = 10.5\text{ V}$	3	3.5			
	Low-side source (see Note 4)	Duty cycle < 2%, $t_{pw} < 100\ \mu\text{s}$ (see Note 3)	$V_{CC} = 4.5\text{ V}$, $V_{LOWDR} = 0.5\text{ V}$	1.4	1.7		A	
			$V_{CC} = 6.5\text{ V}$, $V_{LOWDR} = 1.5\text{ V}$	2	2.4			
			$V_{CC} = 12\text{ V}$, $V_{LOWDR} = 1.5\text{ V}$	2.5	3			
Output resistance	High-side sink (see Note 4)		$V_{BOOT} - V_{BOOTLO} = 4.5\text{ V}$, $V_{HIGHDR} = 0.5\text{ V}$			5	Ω	
			$V_{BOOT} - V_{BOOTLO} = 6.5\text{ V}$, $V_{HIGHDR} = 0.5\text{ V}$			5		
			$V_{BOOT} - V_{BOOTLO} = 12\text{ V}$, $V_{HIGHDR} = 0.5\text{ V}$			5		
	High-side source (see Note 4)			$V_{BOOT} - V_{BOOTLO} = 4.5\text{ V}$, $V_{HIGHDR} = 4\text{ V}$			75	Ω
				$V_{BOOT} - V_{BOOTLO} = 6.5\text{ V}$, $V_{HIGHDR} = 6\text{ V}$			75	
				$V_{BOOT} - V_{BOOTLO} = 12\text{ V}$, $V_{HIGHDR} = 11.5\text{ V}$			75	
	Low-side sink (see Note 4)			$V_{DRV} = 4.5\text{ V}$, $V_{LOWDR} = 0.5\text{ V}$			9	Ω
				$V_{DRV} = 6.5\text{ V}$, $V_{LOWDR} = 0.5\text{ V}$			7.5	
				$V_{DRV} = 12\text{ V}$, $V_{LOWDR} = 0.5\text{ V}$			6	
	Low-side source (see Note 4)			$V_{DRV} = 4.5\text{ V}$, $V_{LOWDR} = 4\text{ V}$			75	Ω
				$V_{DRV} = 6.5\text{ V}$, $V_{LOWDR} = 6\text{ V}$			75	
				$V_{DRV} = 12\text{ V}$, $V_{LOWDR} = 11.5\text{ V}$			75	

NOTES: 3. Ensured by design, not production tested.

4. The pull-up/pull-down circuits of the drivers are bipolar and MOSFET transistors in parallel. The peak output current rating is the combined current from the bipolar and MOSFET transistors. The output resistance is the $R_{ds(on)}$ of the MOSFET transistor when the voltage on the driver output is less than the saturation voltage of the bipolar transistor.

dead time

PARAMETER		TEST CONDITIONS	MIN	TYP	MAX	UNIT
V_{IH}	High-level input voltage	LOWDR Over the V_{CC} range (see Note 3)	0.7 V_{CC}			V
V_{IL}	Low-level input voltage		1			
V_{IH}	High-level input voltage	DT Over the V_{CC} range	0.7 V_{CC}			V
V_{IL}	Low-level input voltage		1			

NOTE 3: Ensured by design, not production tested.

digital control terminals

PARAMETER		TEST CONDITIONS	MIN	TYP	MAX	UNIT
V_{IH}	High-level input voltage	Over the V_{CC} range	0.7 V_{CC}			V
V_{IL}	Low-level input voltage		1			V



TPS2832, TPS2833
FAST SYNCHRONOUS-BUCK MOSFET DRIVERS
WITH DEAD-TIME CONTROL

SLVS195C – FEBRUARY 1999 – REVISED JANUARY 2001

**switching characteristics over recommended operating virtual junction temperature range,
 $C_L = 3.3 \text{ nF}$ (unless otherwise noted)**

PARAMETER		TEST CONDITIONS	MIN	TYP	MAX	UNIT
Rise time	HIGHDR output (see Note 3)	$V_{BOOT} = 4.5 \text{ V}, V_{BOOTLO} = 0 \text{ V}$			60	ns
		$V_{BOOT} = 6.5 \text{ V}, V_{BOOTLO} = 0 \text{ V}$			50	
		$V_{BOOT} = 12 \text{ V}, V_{BOOTLO} = 0 \text{ V}$			50	
	LOWDR output (see Note 3)	$V_{CC} = 4.5 \text{ V}$			40	ns
		$V_{CC} = 6.5 \text{ V}$			30	
		$V_{CC} = 12 \text{ V}$			30	
Fall time	HIGHDR output (see Note 3)	$V_{BOOT} = 4.5 \text{ V}, V_{BOOTLO} = 0 \text{ V}$			60	ns
		$V_{BOOT} = 6.5 \text{ V}, V_{BOOTLO} = 0 \text{ V}$			50	
		$V_{BOOT} = 12 \text{ V}, V_{BOOTLO} = 0 \text{ V}$			50	
	LOWDR output (see Note 3)	$V_{CC} = 4.5 \text{ V}$			40	ns
		$V_{CC} = 6.5 \text{ V}$			30	
		$V_{CC} = 12 \text{ V}$			30	
Propagation delay time	HIGHDR going low (excluding dead time) (see Note 3)	$V_{BOOT} = 4.5 \text{ V}, V_{BOOTLO} = 0 \text{ V}$			130	ns
		$V_{BOOT} = 6.5 \text{ V}, V_{BOOTLO} = 0 \text{ V}$			100	
		$V_{BOOT} = 12 \text{ V}, V_{BOOTLO} = 0 \text{ V}$			75	
	LOWDR going high (excluding dead time) (see Note 3)	$V_{BOOT} = 4.5 \text{ V}, V_{BOOTLO} = 0 \text{ V}$			80	ns
		$V_{BOOT} = 6.5 \text{ V}, V_{BOOTLO} = 0 \text{ V}$			70	
		$V_{BOOT} = 12 \text{ V}, V_{BOOTLO} = 0 \text{ V}$			60	
Propagation delay time	LOWDR going low (excluding dead time) (see Note 3)	$V_{CC} = 4.5 \text{ V}$			80	ns
		$V_{CC} = 6.5 \text{ V}$			70	
		$V_{CC} = 12 \text{ V}$			60	
Driver nonoverlap time	DT to LOWDR and LOWDR to HIGHDR (see Note 3)	$V_{CC} = 4.5 \text{ V}$	40		170	ns
		$V_{CC} = 6.5 \text{ V}$	25		135	
		$V_{CC} = 12 \text{ V}$	15		85	

NOTE 3: Ensured by design, not production tested.

TPS2832, TPS2833
FAST SYNCHRONOUS-BUCK MOSFET DRIVERS
WITH DEAD-TIME CONTROL

SLVS195C – FEBRUARY 1999 – REVISED JANUARY 2001

TYPICAL CHARACTERISTICS

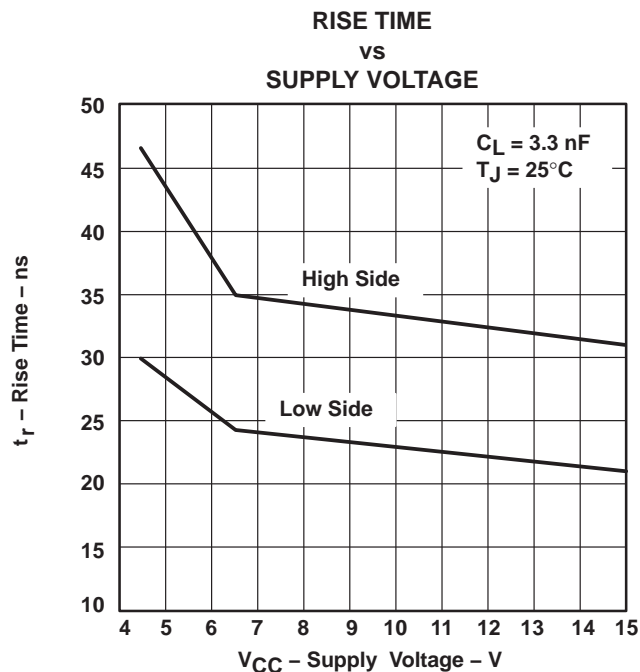

Figure 1

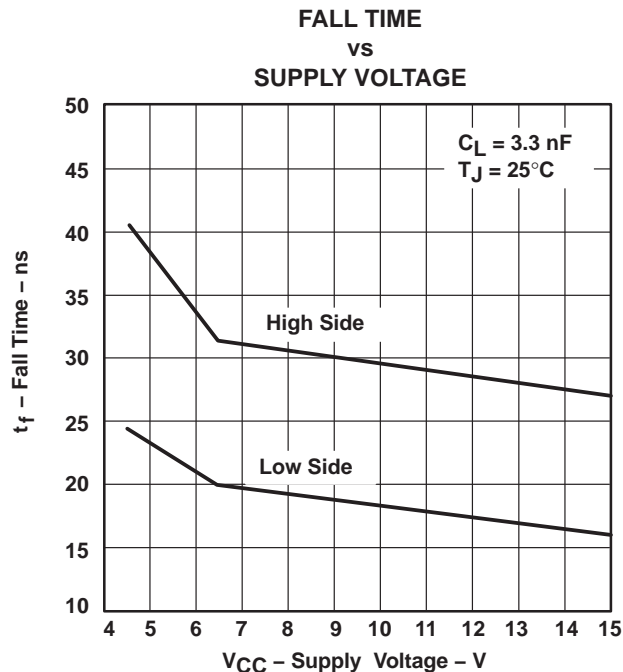

Figure 2

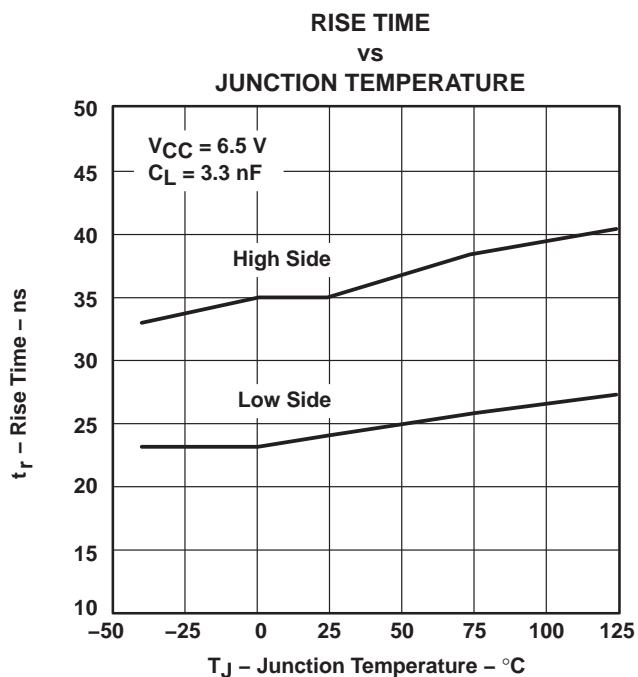

Figure 3

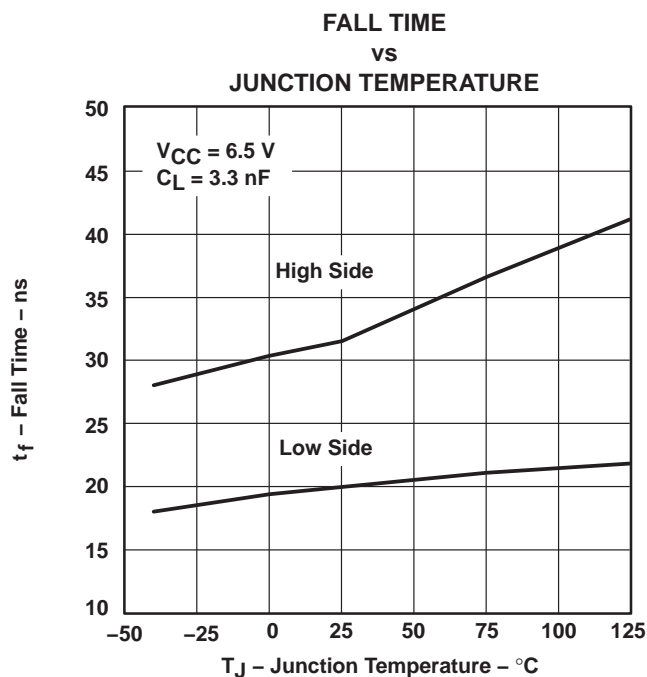

Figure 4

TPS2832, TPS2833
FAST SYNCHRONOUS-BUCK MOSFET DRIVERS
WITH DEAD-TIME CONTROL

SLVS195C – FEBRUARY 1999 – REVISED JANUARY 2001

TYPICAL CHARACTERISTICS

LOW-TO-HIGH PROPAGATION DELAY TIME
vs
SUPPLY VOLTAGE, LOW TO HIGH LEVEL

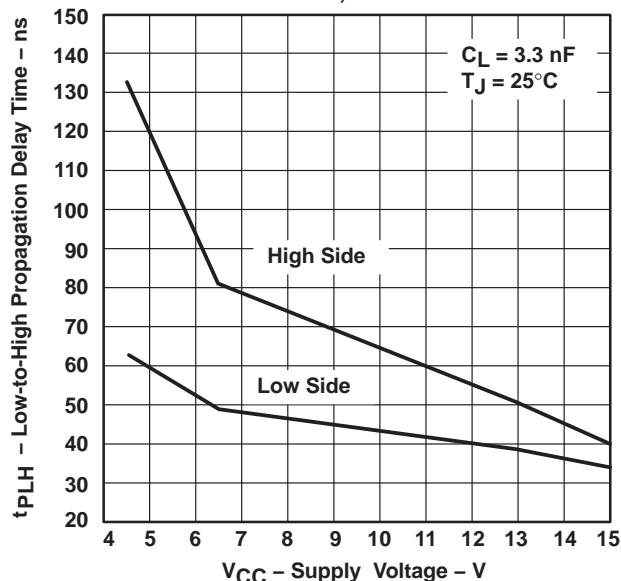

Figure 5

HIGH-TO-LOW PROPAGATION DELAY TIME
vs
SUPPLY VOLTAGE, HIGH TO LOW LEVEL

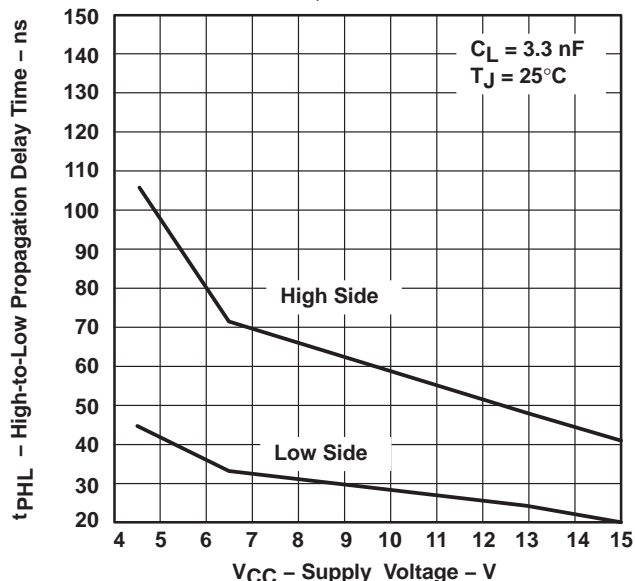

Figure 6

LOW-TO-HIGH PROPAGATION DELAY TIME
vs
JUNCTION TEMPERATURE

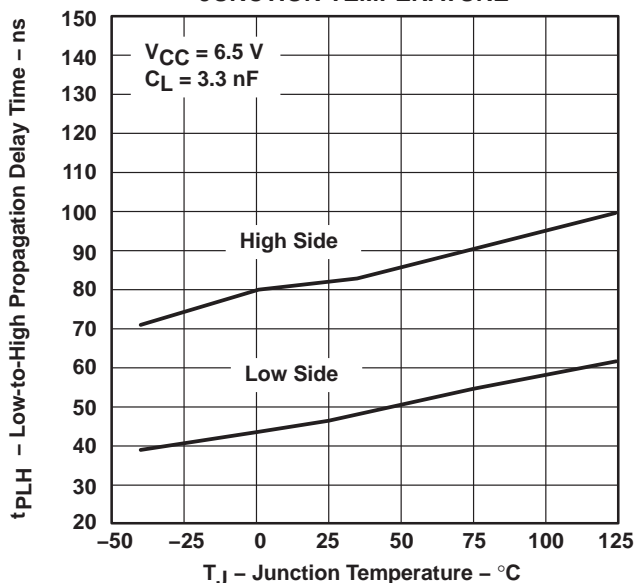

Figure 7

HIGH-TO-LOW PROPAGATION DELAY TIME
vs
JUNCTION TEMPERATURE

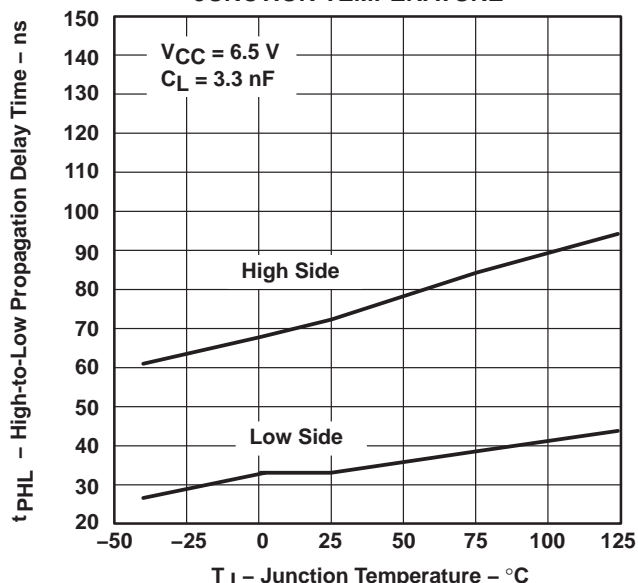

Figure 8



TYPICAL CHARACTERISTICS

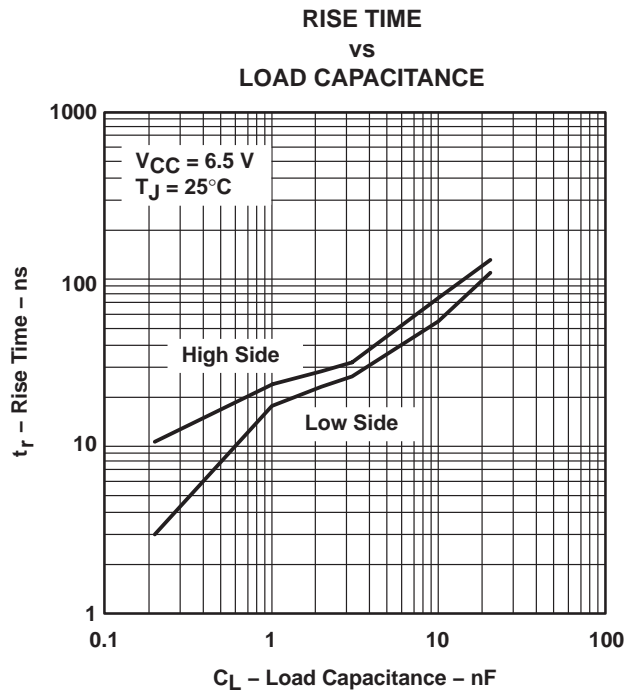

Figure 9

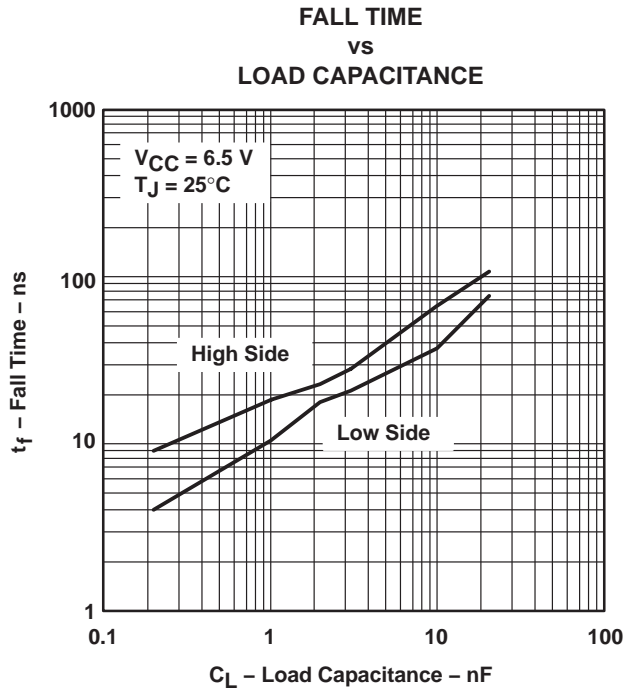

Figure 10

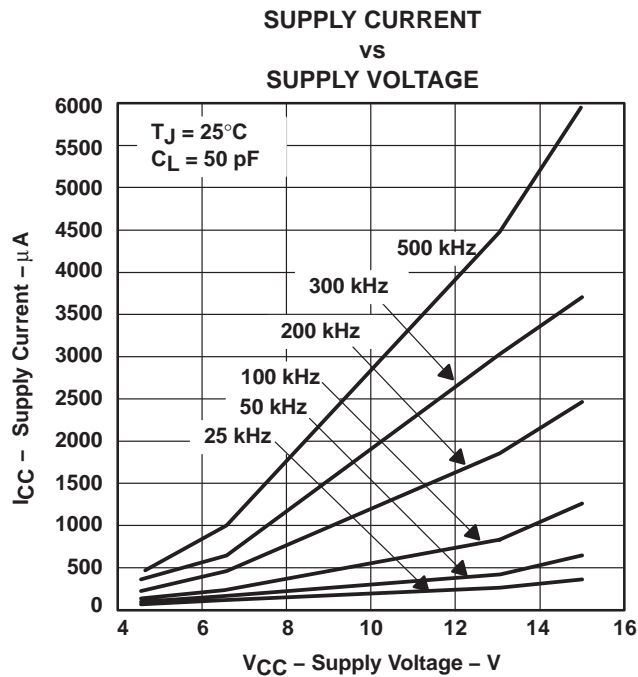

Figure 11

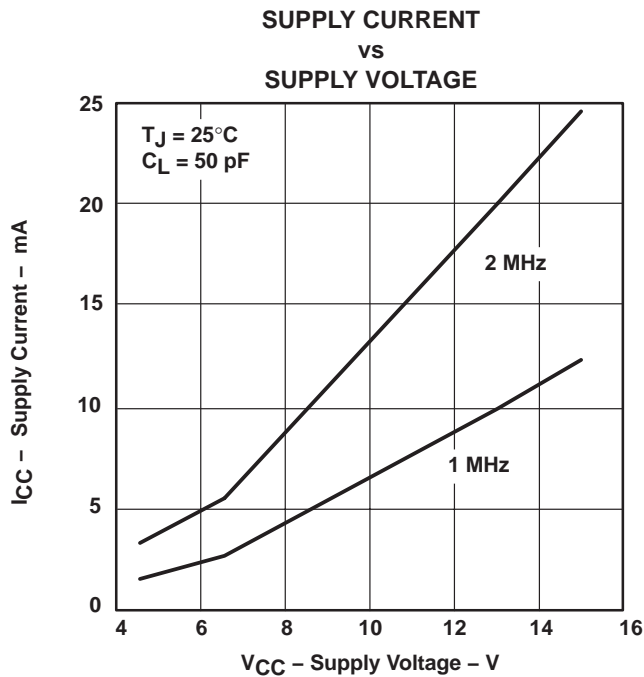

Figure 12

TPS2832, TPS2833
FAST SYNCHRONOUS-BUCK MOSFET DRIVERS
WITH DEAD-TIME CONTROL

SLVS195C – FEBRUARY 1999 – REVISED JANUARY 2001

TYPICAL CHARACTERISTICS

PEAK SOURCE CURRENT
vs
SUPPLY VOLTAGE

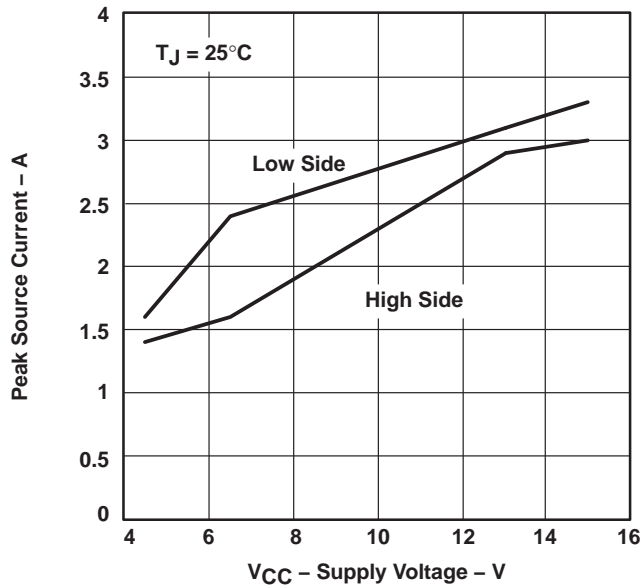

Figure 13

PEAK SINK CURRENT
vs
SUPPLY VOLTAGE

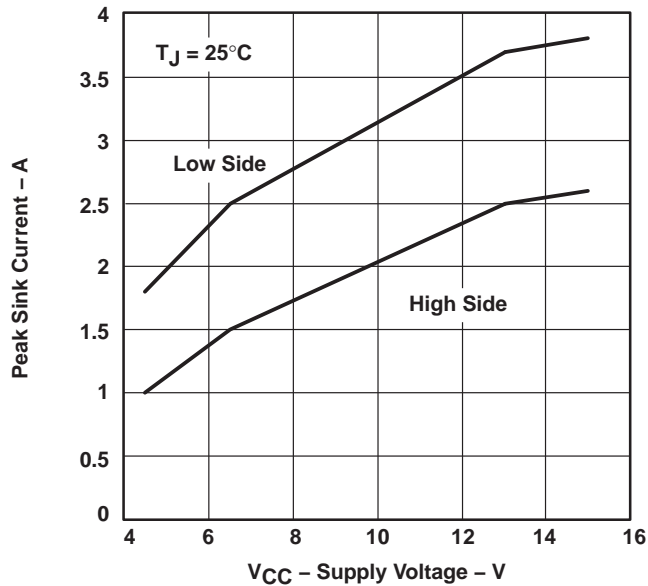

Figure 14

INPUT THRESHOLD VOLTAGE
vs
SUPPLY VOLTAGE

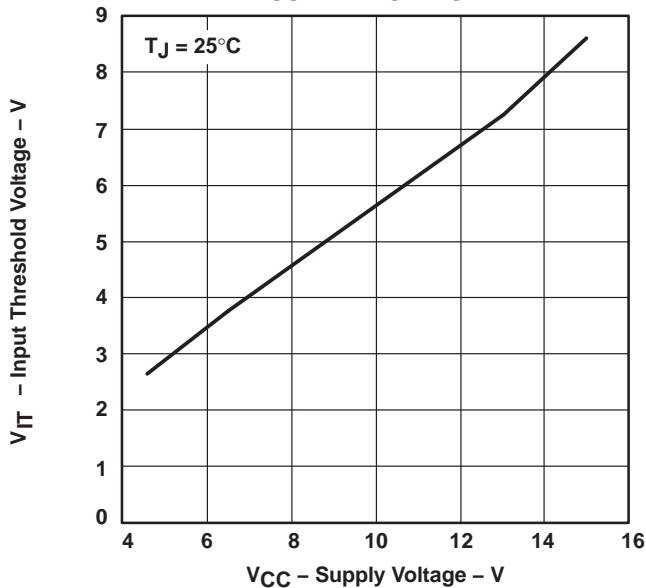

Figure 15



TPS2832, TPS2833 FAST SYNCHRONOUS-BUCK MOSFET DRIVERS WITH DEAD-TIME CONTROL

SLVS195C – FEBRUARY 1999 – REVISED JANUARY 2001

APPLICATION INFORMATION

Figure 16 shows the circuit schematic of a 100-kHz synchronous-buck converter implemented with a TL5001A pulse-width-modulation (PWM) controller and a TPS2833 driver. The converter operates over an input range from 4.5 V to 12 V and has a 3.3 V output. The circuit can supply 3 A continuous load and the transient load is 5 A. The converter achieves an efficiency of 94% for $V_{IN} = 5\text{ V}$, $I_{load} = 1\text{ A}$, and 93% for $V_{IN} = 5\text{ V}$, $I_{load} = 3\text{ A}$.

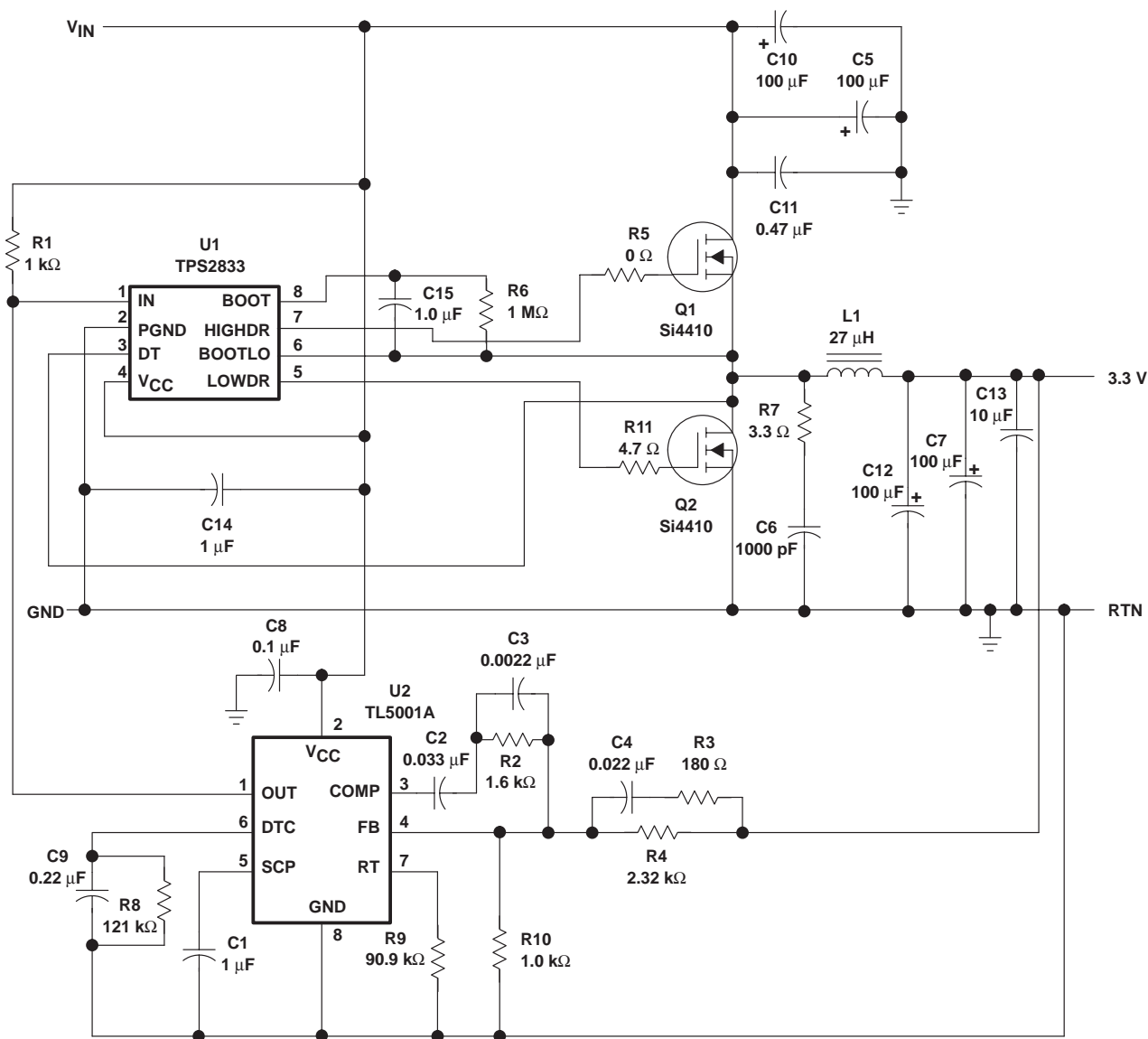

Figure 16. 3.3 V 3 A Synchronous-Buck Converter Circuit

TPS2832, TPS2833 FAST SYNCHRONOUS-BUCK MOSFET DRIVERS WITH DEAD-TIME CONTROL

SLVS195C – FEBRUARY 1999 – REVISED JANUARY 2001

APPLICATION INFORMATION

Great care should be taken when laying out the pc board. The power-processing section is the most critical and will generate large amounts of EMI if not properly configured. The junction of Q1, Q2, and L1 should be very tight. The connection from Q1 drain to the positive sides of C5, C10, and C11 and the connection from Q2 source to the negative sides of C5, C10, and C11 should be as short as possible. The negative terminals of C7 and C12 should also be connected to Q2 source.

Next, the traces from the MOSFET driver to the power switches should be considered. The BOOTLO signal from the junction of Q1 and Q2 carries the large gate drive current pulses and should be as heavy as the gate drive traces. The bypass capacitor (C14) should be tied directly across V_{CC} and PGND.

The next most sensitive node is the FB node on the controller (terminal 4 on the TL5001A) This node is very sensitive to noise pickup and should be isolated from the high-current power stage and be as short as possible. The ground around the controller and low-level circuitry should be tied to the power ground as the output. If these three areas are properly laid out, the rest of the circuit should not have any other EMI problems and the power supply will be relatively free of noise.



POST OFFICE BOX 655303 • DALLAS, TEXAS 75265

PACKAGING INFORMATION

Orderable Device	Status (1)	Package Type	Package Drawing	Pins	Package Qty	Eco Plan (2)	Lead/Ball Finish (6)	MSL Peak Temp (3)	Op Temp (°C)	Device Marking (4/5)	Samples
TPS2832D	ACTIVE	SOIC	D	8	75	Green (RoHS & no Sb/Br)	NIPDAU	Level-1-260C-UNLIM	-40 to 125	2832	Samples
TPS2832DR	ACTIVE	SOIC	D	8	2500	Green (RoHS & no Sb/Br)	NIPDAU	Level-1-260C-UNLIM	-40 to 125	2832	Samples
TPS2833D	ACTIVE	SOIC	D	8	75	Green (RoHS & no Sb/Br)	NIPDAU	Level-1-260C-UNLIM	-40 to 125	2833	Samples

(1) The marketing status values are defined as follows:

ACTIVE: Product device recommended for new designs.

LIFEBUY: TI has announced that the device will be discontinued, and a lifetime-buy period is in effect.

NRND: Not recommended for new designs. Device is in production to support existing customers, but TI does not recommend using this part in a new design.

PREVIEW: Device has been announced but is not in production. Samples may or may not be available.

OBsolete: TI has discontinued the production of the device.

(2) **RoHS:** TI defines "RoHS" to mean semiconductor products that are compliant with the current EU RoHS requirements for all 10 RoHS substances, including the requirement that RoHS substance do not exceed 0.1% by weight in homogeneous materials. Where designed to be soldered at high temperatures, "RoHS" products are suitable for use in specified lead-free processes. TI may reference these types of products as "Pb-Free".

RoHS Exempt: TI defines "RoHS Exempt" to mean products that contain lead but are compliant with EU RoHS pursuant to a specific EU RoHS exemption.

Green: TI defines "Green" to mean the content of Chlorine (Cl) and Bromine (Br) based flame retardants meet JS709B low halogen requirements of <=1000ppm threshold. Antimony trioxide based flame retardants must also meet the <=1000ppm threshold requirement.

(3) MSL, Peak Temp. - The Moisture Sensitivity Level rating according to the JEDEC industry standard classifications, and peak solder temperature.

(4) There may be additional marking, which relates to the logo, the lot trace code information, or the environmental category on the device.

(5) Multiple Device Markings will be inside parentheses. Only one Device Marking contained in parentheses and separated by a "-" will appear on a device. If a line is indented then it is a continuation of the previous line and the two combined represent the entire Device Marking for that device.

(6) Lead/Ball Finish - Orderable Devices may have multiple material finish options. Finish options are separated by a vertical ruled line. Lead/Ball Finish values may wrap to two lines if the finish value exceeds the maximum column width.

Important Information and Disclaimer:The information provided on this page represents TI's knowledge and belief as of the date that it is provided. TI bases its knowledge and belief on information provided by third parties, and makes no representation or warranty as to the accuracy of such information. Efforts are underway to better integrate information from third parties. TI has taken and continues to take reasonable steps to provide representative and accurate information but may not have conducted destructive testing or chemical analysis on incoming materials and chemicals. TI and TI suppliers consider certain information to be proprietary, and thus CAS numbers and other limited information may not be available for release.

In no event shall TI's liability arising out of such information exceed the total purchase price of the TI part(s) at issue in this document sold by TI to Customer on an annual basis.

TAPE AND REEL INFORMATION



QUADRANT ASSIGNMENTS FOR PIN 1 ORIENTATION IN TAPE



*All dimensions are nominal

Device	Package Type	Package Drawing	Pins	SPQ	Reel Diameter (mm)	Reel Width W1 (mm)	A0 (mm)	B0 (mm)	K0 (mm)	P1 (mm)	W (mm)	Pin1 Quadrant
TPS2832DR	SOIC	D	8	2500	330.0	12.4	6.4	5.2	2.1	8.0	12.0	Q1

TAPE AND REEL BOX DIMENSIONS



*All dimensions are nominal

Device	Package Type	Package Drawing	Pins	SPQ	Length (mm)	Width (mm)	Height (mm)
TPS2832DR	SOIC	D	8	2500	340.5	338.1	20.6

IMPORTANT NOTICE AND DISCLAIMER

TI PROVIDES TECHNICAL AND RELIABILITY DATA (INCLUDING DATASHEETS), DESIGN RESOURCES (INCLUDING REFERENCE DESIGNS), APPLICATION OR OTHER DESIGN ADVICE, WEB TOOLS, SAFETY INFORMATION, AND OTHER RESOURCES "AS IS" AND WITH ALL FAULTS, AND DISCLAIMS ALL WARRANTIES, EXPRESS AND IMPLIED, INCLUDING WITHOUT LIMITATION ANY IMPLIED WARRANTIES OF MERCHANTABILITY, FITNESS FOR A PARTICULAR PURPOSE OR NON-INFRINGEMENT OF THIRD PARTY INTELLECTUAL PROPERTY RIGHTS.

These resources are intended for skilled developers designing with TI products. You are solely responsible for (1) selecting the appropriate TI products for your application, (2) designing, validating and testing your application, and (3) ensuring your application meets applicable standards, and any other safety, security, or other requirements. These resources are subject to change without notice. TI grants you permission to use these resources only for development of an application that uses the TI products described in the resource. Other reproduction and display of these resources is prohibited. No license is granted to any other TI intellectual property right or to any third party intellectual property right. TI disclaims responsibility for, and you will fully indemnify TI and its representatives against, any claims, damages, costs, losses, and liabilities arising out of your use of these resources.

TI's products are provided subject to TI's Terms of Sale (www.ti.com/legal/termsofsale.html) or other applicable terms available either on ti.com or provided in conjunction with such TI products. TI's provision of these resources does not expand or otherwise alter TI's applicable warranties or warranty disclaimers for TI products.

Mailing Address: Texas Instruments, Post Office Box 655303, Dallas, Texas 75265
Copyright © 2020, Texas Instruments Incorporated