

LOC	DIST	REVISIONS					
J	/	P	LTR	DESCRIPTION	DATE	DWN	APVD
		A		RELEASED	16JUL2008	C.O	Y.N

引き出し方向
USER DIRECTION OF FEED

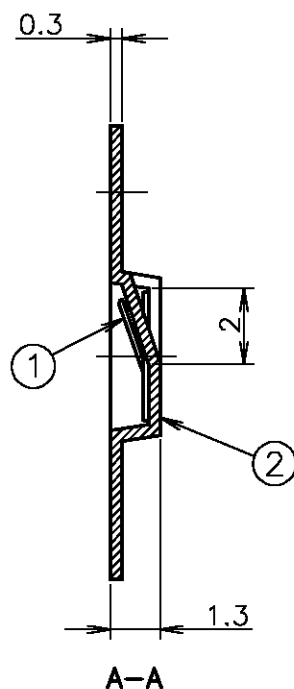
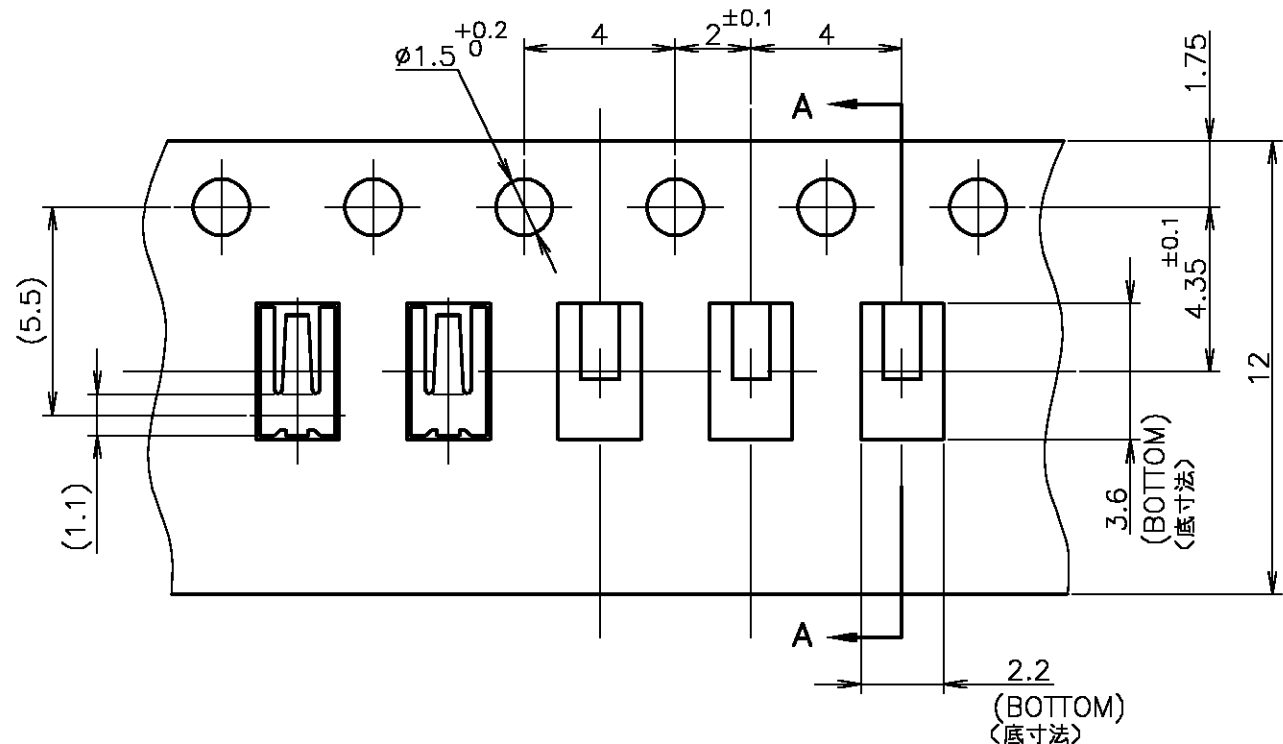

- 1 GENERAL TOLERANCE: ±0.3
- 2 PACKING STYLE: 5,000PCS/REEL
- ③ MATERIAL:
SHIELD FINGER: COPPER ALLOY (NICKEL-PLATING)
(Au PL. 0.00005 MIN.)
(SOLDER-PLATING ON THE BOTTOM PLANE ONLY)

- CARRIER TAPE: ACRYLIC FILM
- TOP TAPE: PET FILM
- REEL: PLASTIC

- 4 TAPES DIMENSION
-

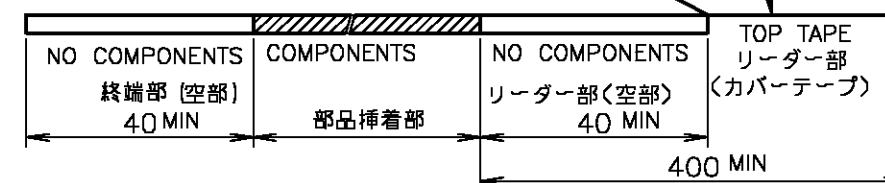

- 5 REEL DIMENSION: REFERENCE ONLY

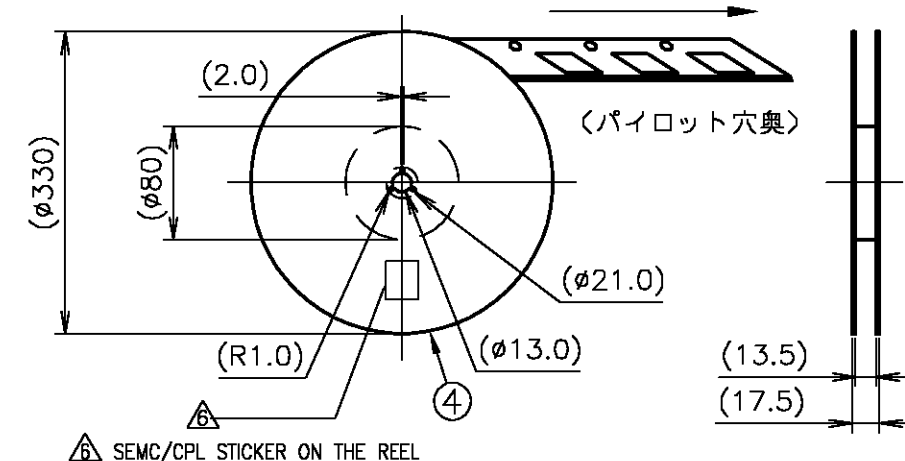

シールドフィンガー0820
SHIELD FINGER 0820
SCALE 10:1

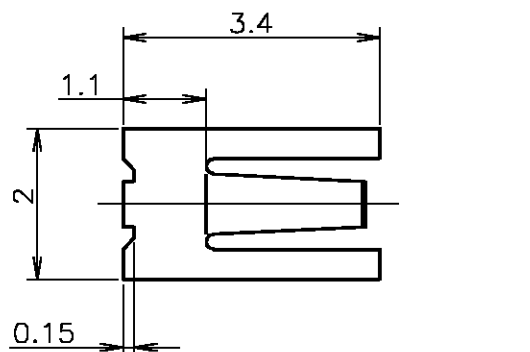

RECOMMENDED FOOT PRINT
REFERENCE ONLY
(GENERAL TOLERANCE ±0.1)
参考パッド寸法 (公差±0.1)

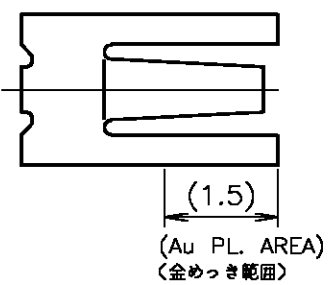
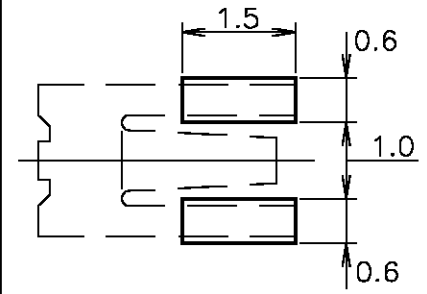

2040852-1	④	REEL	リール	1
	③	COVER TAPE	カバーテープ	1
	②	EMBOSS CARRIER TAPE	エンボスキャリアテープ	5000 POKETS (COMPONENTS)
	①	SHIELD FINGER 0820	シールドフィンガー 0820	5000 PCS
PACKING CAT.NO.	NO.	NAME	名称	QUANTITY

THIS DRAWING IS A CONTROLLED DOCUMENT.		DWN C.OHASHI 16JUL2008	Tyco Electronics Corporation Kawasaki, Japan	
DIMENSIONS: 単位: 概 mm		CHK Y.NAKAZAWA 16JUL2008	NAME 名称 SHIELD FINGER 0820	
TOLERANCES UNLESS OTHERWISE SPECIFIED: 一般公差		APVD Y.NAKAZAWA 16JUL2008	SIZE A3	
0 PLC ± 1 PLC ± SEE NOTE 2 PLC ± 3 PLC ± 4 PLC ± ANGLES ±		PRODUCT SPEC 製品規格	CAGE CODE 00779	DRAWING NO C-2040852
MATERIAL 材料		FINISH 仕上	RESTRICTED TO	SCALE 尺度 5:1
③		WEIGHT	SHEET 1 OF 1	REV A
CUSTOMER DRAWING				

Mouser Electronics

Authorized Distributor

Click to View Pricing, Inventory, Delivery & Lifecycle Information:

[TE Connectivity:](#)

[2040852-1](#)