



Through Hole Lamp Product Data Sheet

LTL-14CHJ

Spec No.: DS-20-92-0018

Effective Date: 05/25/2000

Revision: -

LITE-ON DCC

RELEASE

BNS-OD-FC001/A4

Features

- * Red Orange and Green chips are matched for uniform light output.
- * T-1 type package.
- * Long life solid state reliability.
- * Low power consumption.
- * I.C. compatible.

Package Dimensions

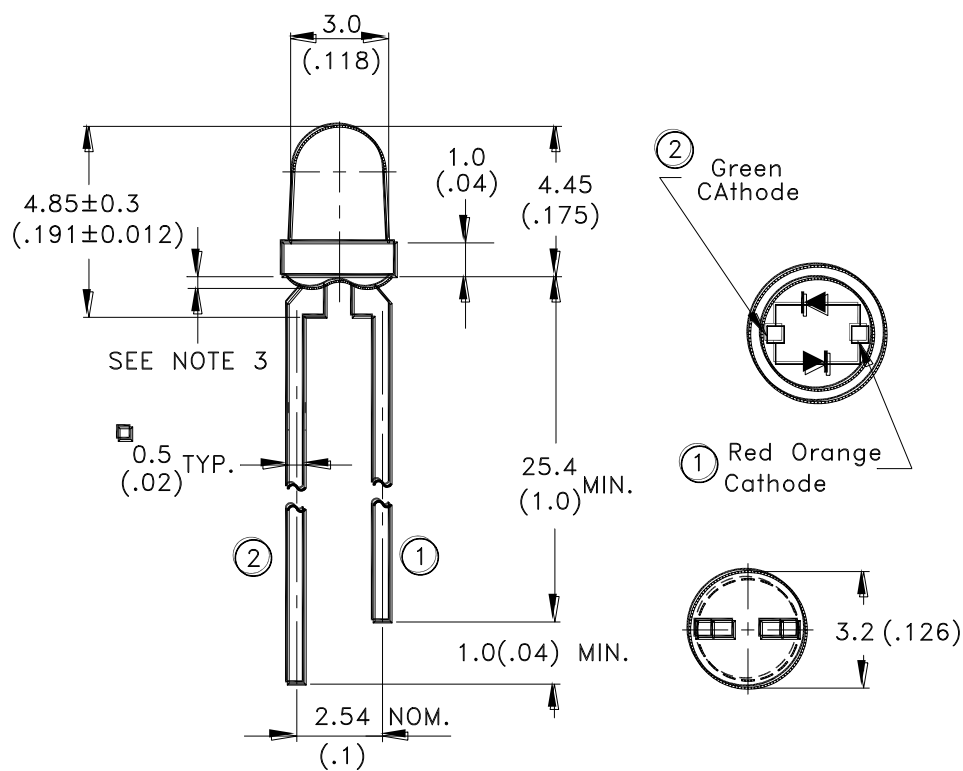

Part No.	Lens	Source Color
LTL-14CHJ	White Diffused	Red Orange / Green

Notes:

1. All dimensions are in millimeters (inches).
2. Tolerance is ±0.25mm(.010") unless otherwise noted.
3. Protruded resin under flange is 1.0mm(.04") max.
4. Lead spacing is measured where the leads emerge from the package.
5. Specifications are subject to change without notice.



Absolute Maximum Ratings at TA=25°C

Parameter	Red Orange	Green	Unit
Power Dissipation	100	100	mW
Peak Forward Current (1/10 Duty Cycle, 0.1ms Pulse Width)	120	120	mA
Continuous Forward Current	30	30	mA
Derating Linear From 50°C	0.4	0.4	mA/°C
Operating Temperature Range	-55°C to + 100°C		
Storage Temperature Range	-55°C to + 100°C		
Lead Soldering Temperature [1.6mm(.063") From Body]	260°C for 5 Seconds		

Electrical / Optical Characteristics at TA=25°C

Parameter	Symbol	Color	Min.	Typ.	Max.	Unit	Test Condition
Luminous Intensity	I _v	Red Orange Green	2.2 2.2	4.8 4.8		mcd	I _F = 20mA Note 1,4
Viewing Angle	2θ _{1/2}	Red Orange Green		200		deg	Note 2 (Fig.6)
Peak Emission Wavelength	λ _p	Red Orange Green		630 565		nm	Measurement @Peak (Fig.1)
Dominant Wavelength	λ _d	Red Orange Green		621 569		nm	Note 3
Spectral Line Half-Width	Δλ	Red Orange Green		40 30		nm	
Forward Voltage	V _F	Red Orange Green		2.0 2.1	2.6 2.6	V	I _F = 20mA
Reverse Current	I _R	Red Orange Green			100	μA	V _R = 5V
Capacitance	C	Red Orange Green		20 35		pF	V _F = 0, f = 1MHz

- Note: 1. Luminous intensity is measured with a light sensor and filter combination that approximates the CIE (Commission International De L'Eclairage) eye-response curve.
2. θ_{1/2} is the off-axis angle at which the luminous intensity is half the axial luminous intensity.
3. The dominant wavelength, λ_d is derived from the CIE chromaticity diagram and represents the single wavelength which defines the color of the device.
4. The I_v guarantee should be added ±15% .
5. Reverse current is controlled by dice source.

Property of Lite-On Only

Typical Electrical / Optical Characteristics Curves

(25°C Ambient Temperature Unless Otherwise Noted)

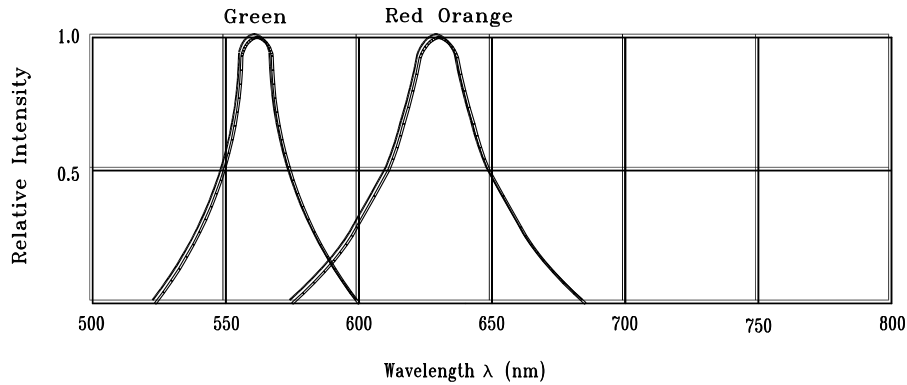

Fig.1 Relative Intensity vs. Wavelength

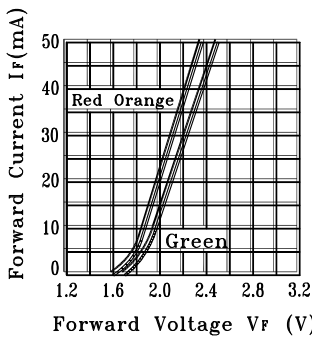

Fig.2 Forward Current vs. Forward Voltage

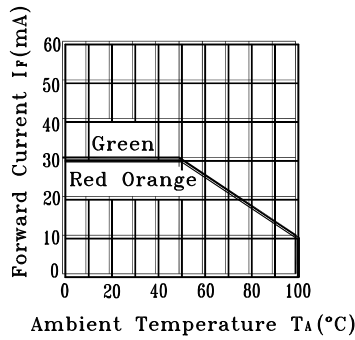

Fig.3 Forward Current Derating Curve

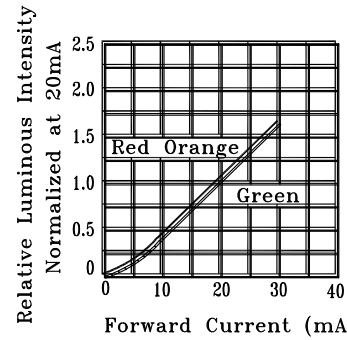

Fig.4 Relative Luminous Intensity vs. Forward Current

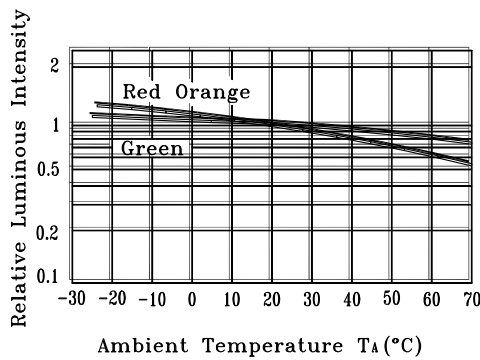

Fig.5 Luminous Intensity vs. Ambient Temperature

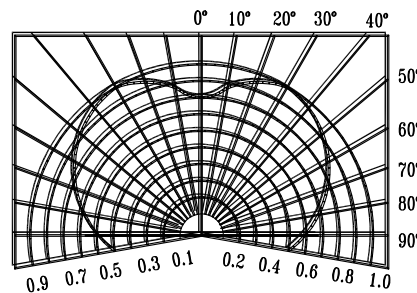

Fig.6 Spatial Distribution

Mouser Electronics

Authorized Distributor

Click to View Pricing, Inventory, Delivery & Lifecycle Information:

[Lite-On:](#)

[LTL-14CHJ](#)