

AMC1305x

High-Precision, Reinforced Isolated Delta-Sigma Modulators

1 Features

- Pin-compatible family optimized for shunt-resistor-based current measurements:
 - ± 50 -mV or ± 250 -mV input voltage ranges
 - CMOS or LVDS digital interface options
- Excellent DC performance supporting high-precision sensing on system level:
 - Offset error: ± 50 μ V or ± 150 μ V (max)
 - Offset drift: 1.3 μ V/ $^{\circ}$ C (max)
 - Gain error: $\pm 0.3\%$ (max)
 - Gain drift: ± 40 ppm/ $^{\circ}$ C (max)
- Safety-related certifications:
 - 7000- V_{PK} reinforced isolation per DIN VDE V 0884-11: 2017-01
 - 5000- V_{RMS} isolation for 1 minute per UL1577
 - CAN/CSA no. 5A-component acceptance service notice and IEC 62368-1 end equipment standard
- Transient immunity: 15 kV/ μ s (min)
- High electromagnetic field immunity (see application note [SLLA181A](#))
- External 5-MHz to 20-MHz clock input for easier system-level synchronization
- Fully specified over the extended industrial temperature range

2 Applications

- Shunt-resistor-based current sensing in:
 - Industrial motor drives
 - Photovoltaic inverters
 - Uninterruptible power supplies
- Isolated voltage sensing

3 Description

The AMC1305 is a precision, delta-sigma ($\Delta\Sigma$) modulator with the output separated from the input circuitry by a capacitive double isolation barrier that is highly resistant to magnetic interference. This barrier is certified to provide reinforced isolation of up to 7000 V_{PEAK} according to the DIN VDE V 0884-11, UL1577, and CSA standards. Used in conjunction with isolated power supplies, the device prevents noise currents on a high common-mode voltage line from entering the local system ground and interfering with or damaging low voltage circuitry.

The AMC1305 is optimized for direct connection to shunt resistors or other low voltage level signal sources and supports excellent dc and ac performance. Shunt resistors are typically used to sense currents in motor drives, green energy generation systems, or other industrial applications. By using an appropriate digital filter (that is, as integrated on the [TMS320F2837x](#)) to decimate the bit stream, the device can achieve 16 bits of resolution with a dynamic range of 85 dB (13.8 ENOB) at a data rate of 78 kSPS.

On the high-side, the modulator is supplied with a nominal voltage of 5 V (AVDD), whereas the isolated digital interface operates from a 3.3-V or 5-V power supply (DVDD).

The AMC1305 is available in a wide-body SOIC-16 (DW) package and is specified from -40° C to $+125^{\circ}$ C.

Device Information⁽¹⁾

PART NUMBER	PACKAGE	BODY SIZE (NOM)
AMC1305x	SOIC (16)	10.30 mm x 7.50 mm

(1) For all available packages, see the orderable addendum at the end of the datasheet.

Simplified Schematic

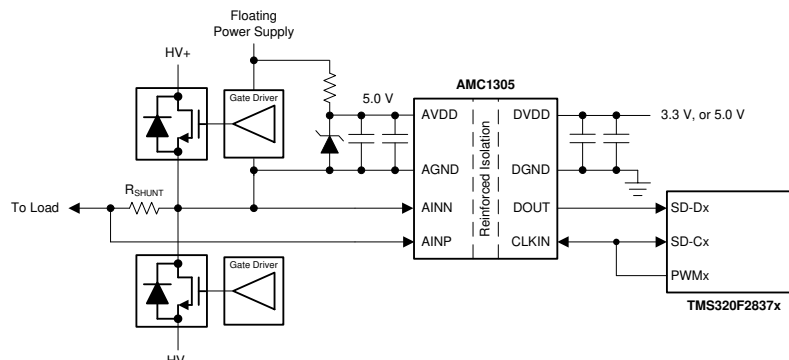

Table of Contents

1 Features	1	8.1 Overview	21
2 Applications	1	8.2 Functional Block Diagram	21
3 Description	1	8.3 Feature Description	22
4 Revision History	2	8.4 Device Functional Modes	24
5 Device Comparison Table	4	9 Application and Implementation	25
6 Pin Configuration and Functions	4	9.1 Application Information	25
7 Specifications	5	9.2 Typical Applications	26
7.1 Absolute Maximum Ratings	5	10 Power Supply Recommendations	30
7.2 ESD Ratings	5	11 Layout	31
7.3 Recommended Operating Conditions	5	11.1 Layout Guidelines	31
7.4 Thermal Information	5	11.2 Layout Examples	31
7.5 Power Ratings	5	12 Device and Documentation Support	33
7.6 Insulation Specifications	6	12.1 Documentation Support	33
7.7 Safety-Related Certifications	7	12.2 Related Links	33
7.8 Safety Limiting Values	7	12.3 Receiving Notification of Documentation Updates	33
7.9 Electrical Characteristics: AMC1305M05	8	12.4 Support Resources	33
7.10 Electrical Characteristics: AMC1305x25	10	12.5 Trademarks	33
7.11 Switching Characteristics	12	12.6 Electrostatic Discharge Caution	33
7.12 Insulation Characteristics Curves	13	12.7 Glossary	33
7.13 Typical Characteristics	14	13 Mechanical, Packaging, and Orderable Information	34
8 Detailed Description	21		

4 Revision History

NOTE: Page numbers for previous revisions may differ from page numbers in the current version.

Changes from Revision F (March 2017) to Revision G	Page
• Changed VDE certificate revision from <i>DIN V VDE V 0884-10 (VDE V 0884-10): 2006-12</i> to <i>DIN VDE V 0884-11: 2017-01</i> in <i>Safety-related certifications</i> Features bullet	1
• Changed IEC standard revision from <i>IEC 60950-1, and IEC 60065</i> to <i>IEC 62368-1</i> in <i>CAN/CSA no. 5A-component acceptance service notice</i> Features bullet	1
• Changed <i>DIN V VDE V 0884-10</i> to <i>DIN VDE V 0884-11</i> in <i>Description</i> section	1
• Changed <i>DIN V VDE V 0884-10 (VDE V 0884-10): 2006-12</i> header row to <i>DIN VDE V 0884-11: 2017-01</i> in <i>Insulation Specifications</i> table	6
• VDE certificate details in <i>Safety-Related Certifications</i> table	7
• Changed <i>Safety Limiting Values</i> table as per ISO standard: deleted last sentence from condition statement, changed footnotes, deleted paragraph below table	7

Changes from Revision E (January 2017) to Revision F	Page
• Changed minimum specification from DGND – 0.3 to DGND – 0.5 and maximum specification from DVDD + 0.3 to DVDD + 0.5 in <i>Digital input voltage</i> parameter row of <i>Absolute Maximum Ratings</i> table	5

Changes from Revision D (August 2016) to Revision E	Page
• Changed $V_{(ESD)}$ for Human-body model (HBM) from ± 1000 V to ± 2500 V	5

Changes from Revision C (December 2014) to Revision D	Page
• Added last two <i>Features</i> bullets	1
• Changed <i>Simplified Schematic</i> figure.....	1
• Moved <i>Power Rating, Insulation Specifications, Regulatory Information, and Safety Limiting Values</i> tables	5
• Changed <i>Insulation Specifications</i> table as per ISO standard	6
• Added <i>Insulation Characteristics Curves</i> section	13
• Changed Figure 54	26
• Changed Figure 58	30
<hr/>	
Changes from Revision B (October 2014) to Revision C	Page
• Changed device status of AMC1305M05 to Production Data.....	1
• Changed document status from Mixed Status to Production Data	1
• Updated ESD Ratings table to latest standard	5
<hr/>	
Changes from Revision A (November 2014) to Revision B	Page
• Changed device status of AMC1305M25 to Production Data.....	1
• Changed <i>Features</i> bullet from "Safety and Regulatory Approvals" to "Safety-Related Certifications"	1
<hr/>	
Changes from Original (June 2014) to Revision A	Page
• Made changes to product preview data sheet.....	1

5 Device Comparison Table

PART NUMBER	INPUT VOLTAGE RANGE	DIFFERENTIAL INPUT RESISTANCE	SNR (sinc ³ Filter, 78 kSPS)	OUTPUT INTERFACE
AMC1305L25	±250 mV	25 kΩ	82 dB	LVDS
AMC1305M05	±50 mV	5 kΩ	76 dB	CMOS
AMC1305M25	±250 mV	25 kΩ	82 dB	CMOS

6 Pin Configuration and Functions

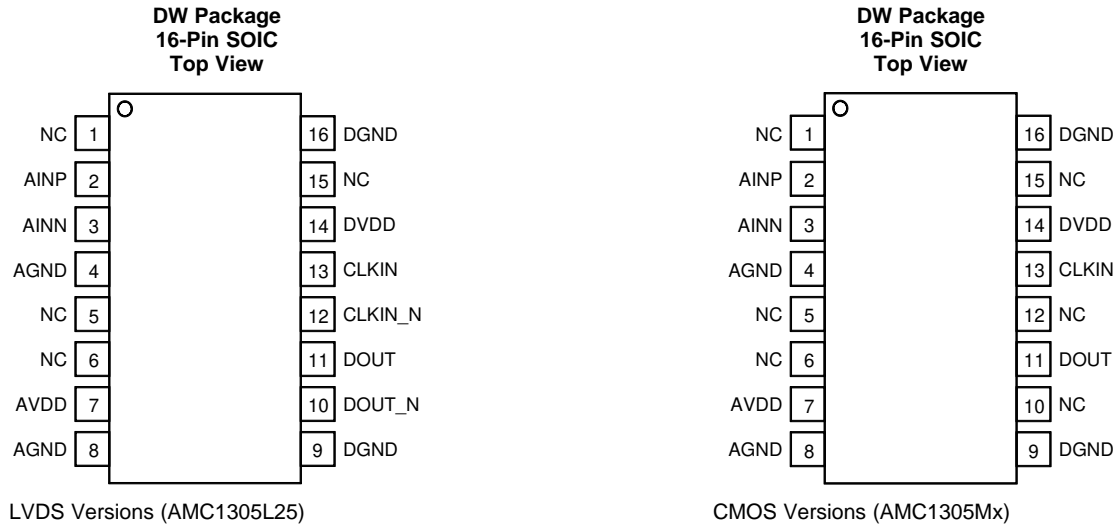

Pin Functions

PIN		I/O	DESCRIPTION
NAME	NO.		
AGND	4	—	This pin is internally connected to pin 8 and can be left unconnected or tied to high-side ground
	8	—	High-side ground reference
AINN	3	I	Inverting analog input
AINP	2	I	Noninverting analog input
AVDD	7	—	High-side power supply, 4.5 V to 5.5 V. See the Power-Supply Recommendations section for decoupling recommendations.
CLKIN	13	I	Modulator clock input, 5 MHz to 20.1 MHz
CLKIN_N	12	I	AMC1305L25 only: inverted modulator clock input
DGND	9, 16	—	Controller-side ground reference
DOUT	11	O	Modulator data output
DOUT_N	10	O	AMC1305L25 only: inverted modulator data output
DVDD	14	—	Controller-side power supply, 3.0 to 5.5 V
NC	1	—	This pin can be connected to AVDD or can be left unconnected
	5	—	This pin can be left unconnected or tied to AGND only
	6, 10, 12	—	These pins have no internal connection (pins 10 and 12 on the AMC1305Mx only).
	15	—	This pin can be left unconnected or tied to DVDD only

7 Specifications

7.1 Absolute Maximum Ratings

over the operating ambient temperature range (unless otherwise noted)⁽¹⁾

	MIN	MAX	UNIT
Supply voltage, AVDD to AGND or DVDD to DGND	-0.3	6.5	V
Analog input voltage at AINP, AINN	AGND – 6	AVDD + 0.5	V
Digital input voltage at CLKIN, CLKIN_N	DGND – 0.5	DVDD + 0.5	V
Input current to any pin except supply pins	-10	10	mA
Maximum virtual junction temperature, T _J		150	°C
Storage temperature, T _{stg}	-65	150	°C

(1) Stresses beyond those listed under *Absolute Maximum Ratings* may cause permanent damage to the device. These are stress ratings only, and do not imply functional operation of the device at these or any other conditions beyond those indicated. Exposure to absolute-maximum-rated conditions for extended periods may affect device reliability.

7.2 ESD Ratings

			VALUE	UNIT
V _(ESD)	Electrostatic discharge	Human-body model (HBM), per ANSI/ESDA/JEDEC JS-001 ⁽¹⁾	±2500	V
		Charged-device model (CDM), per JEDEC specification JESD22-C101 ⁽²⁾	±1000	

(1) JEDEC document JEP155 states that 500-V HBM allows safe manufacturing with a standard ESD control process.

(2) JEDEC document JEP157 states that 250-V CDM allows safe manufacturing with a standard ESD control process.

7.3 Recommended Operating Conditions

over operating free-air temperature range (unless otherwise noted)

		MIN	NOM	MAX	UNIT
AVDD	High-side (analog) supply voltage	4.5	5.0	5.5	V
DVDD	Controller-side (digital) supply voltage	3.0	3.3	5.5	V
T _A	Operating ambient temperature range	-40		125	°C

7.4 Thermal Information

THERMAL METRIC ⁽¹⁾		AMC1305x	UNIT
		DW (SOIC)	
		16 PINS	
R _{θJA}	Junction-to-ambient thermal resistance	80.2	°C/W
R _{θJC(top)}	Junction-to-case (top) thermal resistance	40.5	°C/W
R _{θJB}	Junction-to-board thermal resistance	45.1	°C/W
ψ _{JT}	Junction-to-top characterization parameter	11.9	°C/W
ψ _{JB}	Junction-to-board characterization parameter	44.5	°C/W
R _{θJC(bot)}	Junction-to-case (bottom) thermal resistance	n/a	°C/W

(1) For more information about traditional and new thermal metrics, see the [Semiconductor and IC package thermal metrics application report](#).

7.5 Power Ratings

PARAMETER		TEST CONDITIONS	VALUE	UNIT
P _D	Maximum power dissipation (both sides)	AVDD = 5.5 V, DVDD = 5.5 V, LVDS, R _{LOAD} = 100 Ω	89.1	mW
P _{D1}	Maximum power dissipation (high-side supply)	AVDD = 5.5 V	45.1	mW
P _{D2}	Maximum power dissipation (low-side supply)	DVDD = 5.5 V, LVDS, R _{LOAD} = 100 Ω	44	mW

7.6 Insulation Specifications

PARAMETER		TEST CONDITIONS	VALUE	UNIT
GENERAL				
CLR	Minimum air gap (clearance) ⁽¹⁾	Shortest pin-to-pin distance through air	≥ 8	mm
CPG	Minimum external tracking (creepage) ⁽¹⁾	Shortest pin-to-pin distance across the package surface	≥ 8	mm
DTI	Distance through insulation	Minimum internal gap (internal clearance) of the double insulation (2 × 0.0135 mm)	0.027	mm
CTI	Comparative tracking index	DIN EN 60112 (VDE 0303-11); IEC 60112	≥ 600	V
	Material group	According to IEC 60664-1	I	
	Overvoltage category per IEC 60664-1	Rated mains voltage ≤ 300 V _{RMS}	I-IV	
		Rated mains voltage ≤ 600 V _{RMS}	I-III	
		Rated mains voltage ≤ 1000 V _{RMS}	I-II	
DIN VDE V 0884-11: 2017-01⁽²⁾				
V _{IORM}	Maximum repetitive peak isolation voltage	At ac voltage (bipolar or unipolar)	1414	V _{PK}
V _{IOWM}	Maximum-rated isolation working voltage	At ac voltage (sine wave)	1000	V _{RMS}
		At dc voltage	1500	V _{DC}
V _{IOTM}	Maximum transient isolation voltage	V _{TEST} = V _{IOTM} , t = 60 s (qualification test)	7000	V _{PK}
		V _{TEST} = 1.2 × V _{IOTM} , t = 1 s (100% production test)	8400	
V _{IOSM}	Maximum surge isolation voltage ⁽³⁾	Test method per IEC 60065, 1.2/50-μs waveform, V _{TEST} = 1.6 × V _{IOSM} = 10000 V _{PK} (qualification)	6250	V _{PK}
q _{pd}	Apparent charge ⁽⁴⁾	Method a, after input/output safety test subgroup 2 / 3, V _{ini} = V _{IOTM} , t _{ini} = 60 s, V _{pd(m)} = 1.2 × V _{IORM} = 1697 V _{PK} , t _m = 10 s	≤ 5	pC
		Method a, after environmental tests subgroup 1, V _{ini} = V _{IOTM} , t _{ini} = 60 s, V _{pd(m)} = 1.6 × V _{IORM} = 2263 V _{PK} , t _m = 10 s	≤ 5	pC
		Method b1, at routine test (100% production) and preconditioning (type test), V _{ini} = V _{IOTM} , t _{ini} = 1 s, V _{pd(m)} = 1.875 × V _{IORM} = 2652 V _{PK} , t _m = 1 s	≤ 5	pC
C _{IO}	Barrier capacitance, input to output ⁽⁵⁾	V _{IO} = 0.5 V _{PP} at 1 MHz	1.2	pF
R _{IO}	Insulation resistance, input to output ⁽⁵⁾	V _{IO} = 500 V at T _S = 150°C	> 10 ⁹	Ω
	Pollution degree		2	
	Climatic category		40/125/21	
UL1577				
V _{ISO}	Withstand isolation voltage	V _{TEST} = V _{ISO} = 5000 V _{RMS} or 7000 V _{DC} , t = 60 s (qualification test), V _{TEST} = 1.2 × V _{ISO} = 6000 V _{RMS} , t = 1 s (100% production test)	5000	V _{RMS}

- (1) Apply creepage and clearance requirements according to the specific equipment isolation standards of an application. Care must be taken to maintain the creepage and clearance distance of a board design to ensure that the mounting pads of the isolator on the printed circuit board (PCB) do not reduce this distance. Creepage and clearance on a PCB become equal in certain cases. Techniques such as inserting grooves or ribs on the PCB are used to help increase these specifications.
- (2) This coupler is suitable for *safe electrical insulation* only within the safety ratings. Compliance with the safety ratings shall be ensured by means of suitable protective circuits.
- (3) Testing is carried out in air or oil to determine the intrinsic surge immunity of the isolation barrier.
- (4) Apparent charge is electrical discharge caused by a partial discharge (pd).
- (5) All pins on each side of the barrier are tied together, creating a two-pin device.

7.7 Safety-Related Certifications

VDE	UL
Certified according to DIN VDE V 0884-11: 2017-01, DIN EN 62368-1: 2016-05, EN 62368-1: 2014, and IEC 62368-1: 2014	Recognized under UL1577 component recognition and CSA component acceptance NO 5 programs
Reinforced insulation	Single protection
Certificate number: 40040142	File number: E181974

7.8 Safety Limiting Values

Safety limiting intends to prevent potential damage to the isolation barrier upon failure of input or output circuitry.

PARAMETER		TEST CONDITIONS	MIN	TYP	MAX	UNIT
I _S	Safety input, output, or supply current	R _{θJA} = 80.2°C/W, AVDD = DVDD = 5.5 V, T _J = 150°C, T _A = 25°C, see Figure 3			283	mA
		R _{θJA} = 80.2°C/W, AVDD = DVDD = 3.6 V, T _J = 150°C, T _A = 25°C, see Figure 3			432	mA
P _S	Safety input, output, or total power	R _{θJA} = 80.2°C/W, T _J = 150°C, T _A = 25°C, see Figure 4			1558 ⁽¹⁾	mW
T _S	Maximum safety temperature				150	°C

- (1) The maximum safety temperature, T_S, has the same value as the maximum junction temperature, T_J, specified for the device. The I_S and P_S parameters represent the safety current and safety power, respectively. Do not exceed the maximum limits of I_S and P_S. These limits vary with the ambient temperature, T_A.

The junction-to-air thermal resistance, R_{θJA}, in the [Thermal Information](#) table is that of a device installed on a high-K test board for leaded surface-mount packages. Use these equations to calculate the value for each parameter:

T_J = T_A + R_{θJA} × P, where P is the power dissipated in the device.

T_{J(max)} = T_S = T_A + R_{θJA} × P_S, where T_{J(max)} is the maximum junction temperature.

P_S = I_S × AVDD_{max} + I_S × DVDD_{max}, where AVDD_{max} is the maximum high-side voltage and DVDD_{max} is the maximum controller-side supply voltage.

7.9 Electrical Characteristics: AMC1305M05

All minimum and maximum specifications at $T_A = -40^\circ\text{C}$ to $+125^\circ\text{C}$, $AVDD = 4.5\text{ V}$ to 5.5 V , $DVDD = 3.0\text{ V}$ to 5.5 V , $AINP = -50\text{ mV}$ to 50 mV , $AINN = 0\text{ V}$, and sinc³ filter with OSR = 256, unless otherwise noted. Typical values are at $T_A = 25^\circ\text{C}$, $CLKIN = 20\text{ MHz}$, $AVDD = 5.0\text{ V}$, and $DVDD = 3.3\text{ V}$.

PARAMETER	TEST CONDITIONS	MIN	TYP	MAX	UNIT		
ANALOG INPUTS							
$V_{Clipping}$	Maximum differential voltage input range (AINP-AINN)		±62.5		mV		
FSR	Specified linear full-scale range (AINP-AINN)	-50		50	mV		
V_{CM}	Operating common-mode input range	-0.032		$AVDD - 2$	V		
C_{ID}	Differential input capacitance		2		pF		
I_{IB}	Input current	Inputs shorted to AGND			µA		
R_{ID}	Differential input resistance		5		kΩ		
I_{OS}	Input offset current		±5		nA		
CMTI	Common-mode transient immunity	15			kV/µs		
CMRR	Common-mode rejection ratio	$f_{IN} = 0\text{ Hz}$, $V_{CM\ min} \leq V_{IN} \leq V_{CM\ max}$		-104	dB		
		f_{IN} from 0.1 Hz to 50 kHz, $V_{CM\ min} \leq V_{IN} \leq V_{CM\ max}$		-75			
BW	Input bandwidth		800		kHz		
DC ACCURACY							
DNL	Differential nonlinearity	Resolution: 16 bits		-0.99	0.99	LSB	
INL	Integral nonlinearity ⁽¹⁾	Resolution: 16 bits		-4	±1.5	4	LSB
E_O	Offset error	Initial, at 25°C		-50	±2.5	50	µV
TCE_O	Offset error thermal drift ⁽²⁾			-1.3		1.3	µV/°C
E_G	Gain error	Initial, at 25°C		-0.3%	-0.02%	0.3%	
TCE_G	Gain error thermal drift ⁽³⁾			-40	±20	40	ppm/°C
PSRR	Power-supply rejection ratio	V_{AVDD} from 4.5 to 5.5V, at dc			105		dB
AC ACCURACY							
SNR	Signal-to-noise ratio	$f_{IN} = 1\text{ kHz}$		76	81		dB
SINAD	Signal-to-noise + distortion	$f_{IN} = 1\text{ kHz}$		76	81		dB
THD	Total harmonic distortion	$f_{IN} = 1\text{ kHz}$			-90	-83	dB
SFDR	Spurious-free dynamic range	$f_{IN} = 1\text{ kHz}$		83	92		dB
DIGITAL INPUTS/OUTPUTS							
External Clock							
f_{CLKIN}	Input clock frequency		5	20	20.1	MHz	
Duty _{CLKIN}	Duty cycle	$5\text{ MHz} \leq f_{CLKIN} \leq 20.1\text{ MHz}$		40%	50%	60%	
CMOS Logic Family, CMOS with Schmitt-Trigger							
I_{IN}	Input current	$DGND \leq V_{IN} \leq DVDD$		-1		1	µA
C_{IN}	Input capacitance				5		pF
V_{IH}	High-level input voltage		$0.7 \times DVDD$		$DVDD + 0.3$		V
V_{IL}	Low-level input voltage		-0.3		$0.3 \times DVDD$		V
C_{LOAD}	Output load capacitance	$f_{CLKIN} = 20\text{ MHz}$			30		pF
V_{OH}	High-level output voltage	$I_{OH} = -20\ \mu\text{A}$		$DVDD - 0.1$			V
		$I_{OH} = -4\ \text{mA}$		$DVDD - 0.4$			
V_{OL}	Low-level output voltage	$I_{OL} = 20\ \mu\text{A}$		0.1			V
		$I_{OL} = 4\ \text{mA}$		0.4			

(1) Integral nonlinearity is defined as the maximum deviation from a straight line passing through the end-points of the ideal ADC transfer function expressed as number of LSBs or as a percent of the specified linear full-scale range FSR.

(2) Offset error drift is calculated using the box method as described by the following equation:

$$TCE_O = \frac{value_{MAX} - value_{MIN}}{TempRange}$$

(3) Gain error drift is calculated using the box method as described by the following equation:

$$TCE_G (ppm) = \left(\frac{value_{MAX} - value_{MIN}}{value \times TempRange} \right) \times 10^6$$

Electrical Characteristics: AMC1305M05 (continued)

All minimum and maximum specifications at $T_A = -40^{\circ}\text{C}$ to $+125^{\circ}\text{C}$, $AVDD = 4.5\text{ V}$ to 5.5 V , $DVDD = 3.0\text{ V}$ to 5.5 V , $A\text{INP} = -50\text{ mV}$ to 50 mV , $A\text{INN} = 0\text{ V}$, and sinc³ filter with $\text{OSR} = 256$, unless otherwise noted. Typical values are at $T_A = 25^{\circ}\text{C}$, $\text{CLKIN} = 20\text{ MHz}$, $AVDD = 5.0\text{ V}$, and $DVDD = 3.3\text{ V}$.

PARAMETER		TEST CONDITIONS	MIN	TYP	MAX	UNIT
POWER SUPPLY						
AVDD	High-side supply voltage		4.5	5.0	5.5	V
I _{AVDD}	High-side supply current			6.5	8.2	mA
P _{AVDD}	High-side power dissipation			32.5	45.1	mW
DVDD	Controller-side supply voltage		3.0	3.3	5.5	V
I _{DVDD}	Controller-side supply current	3.0 V ≤ DVDD ≤ 3.6 V		2.7	4.0	mA
		4.5 V ≤ DVDD ≤ 5.5 V		3.2	5.5	
P _{DVDD}	Controller-side power dissipation	3.0 V ≤ DVDD ≤ 3.6 V		8.9	14.4	mW
		4.5 V ≤ DVDD ≤ 5.5 V		16.0	30.3	

7.10 Electrical Characteristics: AMC1305x25

All minimum and maximum specifications at $T_A = -40^\circ\text{C}$ to 125°C , $AVDD = 4.5\text{ V}$ to 5.5 V , $DVDD = 3.0\text{ V}$ to 5.5 V , $AINP = -250\text{ mV}$ to 250 mV , $AINN = 0\text{ V}$, and sinc³ filter with $OSR = 256$, unless otherwise noted. Typical values are at $T_A = 25^\circ\text{C}$, $CLKIN = 20\text{ MHz}$, $AVDD = 5.0\text{ V}$, and $DVDD = 3.3\text{ V}$.

PARAMETER		TEST CONDITIONS	MIN	TYP	MAX	UNIT
ANALOG INPUTS						
$V_{Clipping}$	Maximum differential voltage input range (AINP-AINN)			± 312.5		mV
FSR	Specified linear full-scale range (AINP-AINN)		-250		250	mV
V_{CM}	Operating common-mode input range		-0.16		$AVDD - 2$	V
C_{ID}	Differential input capacitance			1		pF
I_{IB}	Input current	Inputs shorted to AGND	-82	-60	-48	μA
R_{ID}	Differential input resistance			25		k Ω
I_{OS}	Input offset current			± 5		nA
CMTI	Common-mode transient immunity		15			kV/ μs
CMRR	Common-mode rejection ratio	$f_{IN} = 0\text{ Hz}$, $V_{CM\ min} \leq V_{IN} \leq V_{CM\ max}$		-95		dB
		f_{IN} from 0.1 Hz to 50 kHz, $V_{CM\ min} \leq V_{IN} \leq V_{CM\ max}$		-76		
BW	Input bandwidth			1000		kHz
DC ACCURACY						
DNL	Differential nonlinearity	Resolution: 16 bits	-0.99		0.99	LSB
INL	Integral nonlinearity ⁽¹⁾	Resolution: 16 bits	-4	± 1.5	4	LSB
E_O	Offset error	Initial, at 25°C	-150	± 40	150	μV
TCE_O	Offset error thermal drift ⁽²⁾		-1.3		1.3	$\mu\text{V}/^\circ\text{C}$
E_G	Gain error	Initial, at 25°C	-0.3	-0.02	0.3	%FS
TCE_G	Gain error thermal drift ⁽³⁾		-40	± 20	40	ppm/ $^\circ\text{C}$
PSRR	Power-supply rejection ratio	V_{AVDD} from 4.5 V to 5.5 V, at dc		90		dB
AC ACCURACY						
SNR	Signal-to-noise ratio	$f_{IN} = 1\text{ kHz}$	82	85		dB
SINAD	Signal-to-noise + distortion	$f_{IN} = 1\text{ kHz}$	80	84		dB
THD	Total harmonic distortion	$f_{IN} = 1\text{ kHz}$		-90	-83	dB
SFDR	Spurious-free dynamic range	$f_{IN} = 1\text{ kHz}$	83	92		dB
DIGITAL INPUTS/OUTPUTS						
External Clock						
f_{CLKIN}	Input clock frequency		5	20	20.1	MHz
Duty _{CLKIN}	Duty cycle	$5\text{ MHz} \leq f_{CLKIN} \leq 20.1\text{ MHz}$	40%	50%	60%	
CMOS Logic Family (AMC1305M25), CMOS with Schmitt-Trigger						
I_{IN}	Input current	$DGND \leq V_{IN} \leq DVDD$	-1		1	μA
C_{IN}	Input capacitance			5		pF
V_{IH}	High-level input voltage		$0.7 \times DVDD$		$DVDD + 0.3$	V
V_{IL}	Low-level input voltage		-0.3		$0.3 \times DVDD$	V
C_{LOAD}	Output load capacitance	$f_{CLKIN} = 20\text{ MHz}$		30		pF
V_{OH}	High-level output voltage	$I_{OH} = -20\ \mu\text{A}$	$DVDD - 0.1$			V
		$I_{OH} = -4\ \text{mA}$	$DVDD - 0.4$			
V_{OL}	Low-level output voltage	$I_{OL} = 20\ \mu\text{A}$			0.1	V
		$I_{OL} = 4\ \text{mA}$			0.4	

(1) Integral nonlinearity is defined as the maximum deviation from a straight line passing through the end-points of the ideal ADC transfer function expressed as the number of LSBs or as a percent of the specified linear full-scale range FSR.

(2) Offset error drift is calculated using the box method as described by the following equation:

$$TCE_O = \frac{value_{MAX} - value_{MIN}}{TempRange}$$

(3) Gain error drift is calculated using the box method as described by the following equation:

$$TCE_G (ppm) = \left(\frac{value_{MAX} - value_{MIN}}{value \times TempRange} \right) \times 10^6$$

Electrical Characteristics: AMC1305x25 (continued)

All minimum and maximum specifications at $T_A = -40^\circ\text{C}$ to 125°C , $AVDD = 4.5\text{ V}$ to 5.5 V , $DVDD = 3.0\text{ V}$ to 5.5 V , $A_{INP} = -250\text{ mV}$ to 250 mV , $A_{INN} = 0\text{ V}$, and sinc³ filter with $OSR = 256$, unless otherwise noted. Typical values are at $T_A = 25^\circ\text{C}$, $CLKIN = 20\text{ MHz}$, $AVDD = 5.0\text{ V}$, and $DVDD = 3.3\text{ V}$.

PARAMETER	TEST CONDITIONS	MIN	TYP	MAX	UNIT	
LVDS Logic Family (AMC1305L25)						
V_{OD}	Differential output voltage	$R_{LOAD} = 100\ \Omega$	250	350	450	mV
V_{OCM}	Output common-mode voltage		1.125	1.23	1.375	V
I_S	Output short-circuit current			24		mA
V_{ICM}	Input common-mode voltage	$V_{ID} = 100\text{ mV}$	0.05	1.25	3.25	V
V_{ID}	Differential input voltage		100	350	600	mV
I_{IN}	Input current	$DGND \leq V_{IN} \leq 3.3\text{ V}$	-24	0	20	μA
POWER SUPPLY						
$AVDD$	High-side supply voltage		4.5	5.0	5.5	V
I_{AVDD}	High-side supply current			6.5	8.2	mA
P_{AVDD}	High-side power dissipation			32.5	45.1	mW
$DVDD$	Controller-side supply voltage		3.0	3.3	5.5	V
I_{DVDD}	Controller-side supply current	AMC1305L25, $R_{LOAD} = 100\ \Omega$		6.1	8.0	mA
		AMC1305M25, $3.0 \leq DVDD \leq 3.6\text{ V}$, $C_{LOAD} = 5\text{ pF}$		2.7	4.0	
		AMC1305M25, $4.5 \leq DVDD \leq 5.5\text{ V}$, $C_{LOAD} = 5\text{ pF}$		3.2	5.5	
P_{DVDD}	Controller-side power dissipation	AMC1305L25, $R_{LOAD} = 100\ \Omega$		20.1	44.0	mW
		AMC1305M25, $3.0 \leq DVDD \leq 3.6\text{ V}$, $C_{LOAD} = 5\text{ pF}$		8.9	14.4	
		AMC1305M25, $4.5 \leq DVDD \leq 5.5\text{ V}$, $C_{LOAD} = 5\text{ pF}$		16.0	30.3	

7.11 Switching Characteristics

over operating free-air temperature range (unless otherwise noted)

PARAMETER		MIN	TYP	MAX	UNIT
t_{CLK}	CLKIN, CLKIN_N clock period	49.75	50	200	ns
t_{HIGH}	CLKIN, CLKIN_N clock high time	19.9	25	120	ns
t_{LOW}	CLKIN, CLKIN_N clock low time	19.9	25	120	ns
t_D	Falling edge of CLKIN, CLKIN_N to DOUT, DOUT_N valid delay, $C_{LOAD} = 5\text{ pF}$	0		15	ns
t_{iSTART}	Interface startup time (DVDD at 3.0 V min to DOUT, DOUT_N valid with $AVDD \geq 4.5\text{ V}$)	32		32	CLKIN cycles
t_{ASTART}	Analog startup time (AVDD step up to 4.5 V with $DVDD \geq 3.0\text{ V}$)		1		ms

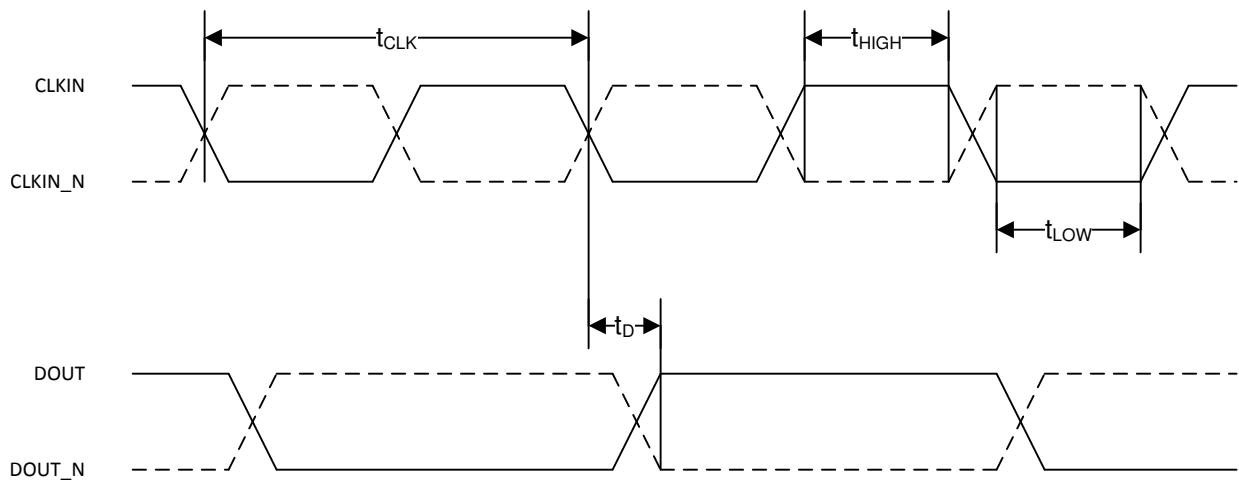

Figure 1. Digital Interface Timing

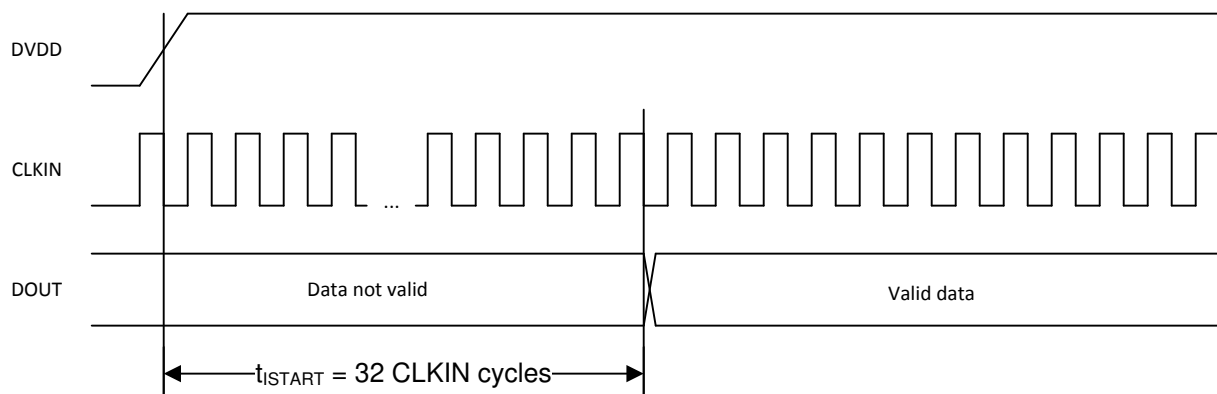
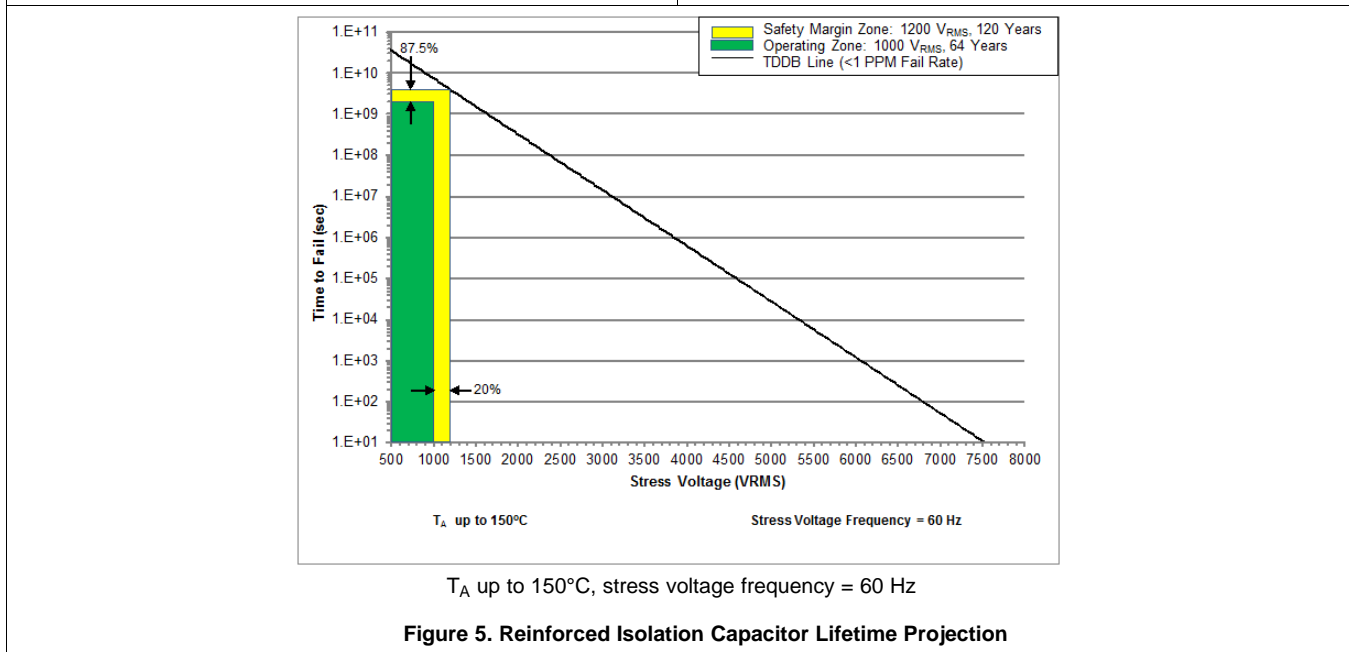
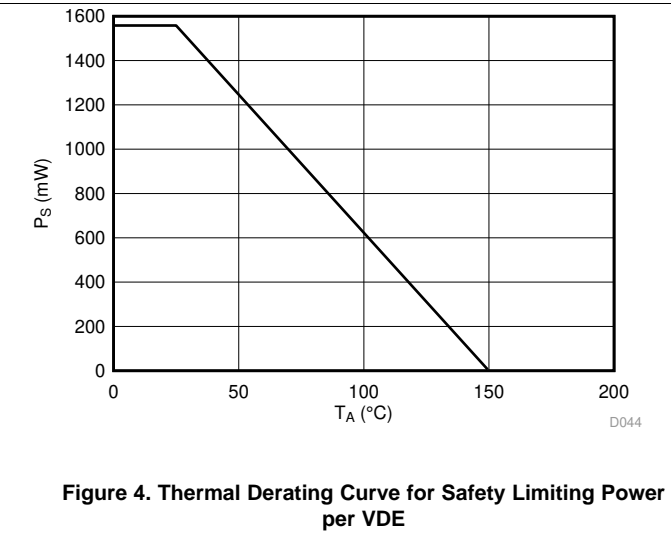
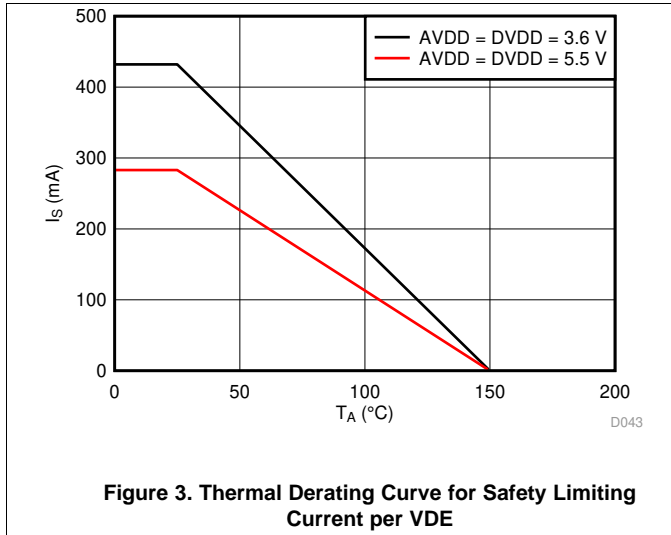

Figure 2. Digital Interface Startup Timing

7.12 Insulation Characteristics Curves



7.13 Typical Characteristics

At $T_A = 25^\circ\text{C}$, $AV_{DD} = 5.0\text{ V}$, $DV_{DD} = 3.3\text{ V}$, $A_{INP} = -250\text{ mV}$ to 250 mV , $A_{INN} = 0\text{ V}$, $f_{CLKIN} = 20\text{ MHz}$, and sinc³ filter with OSR = 256, unless otherwise noted.

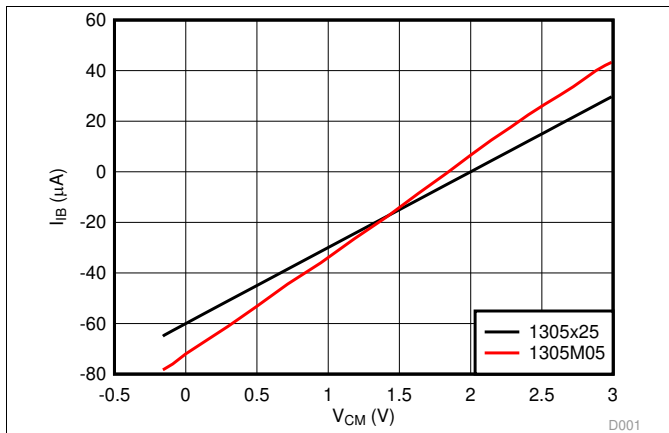

Figure 6. Input Current vs Input Common-Mode Voltage

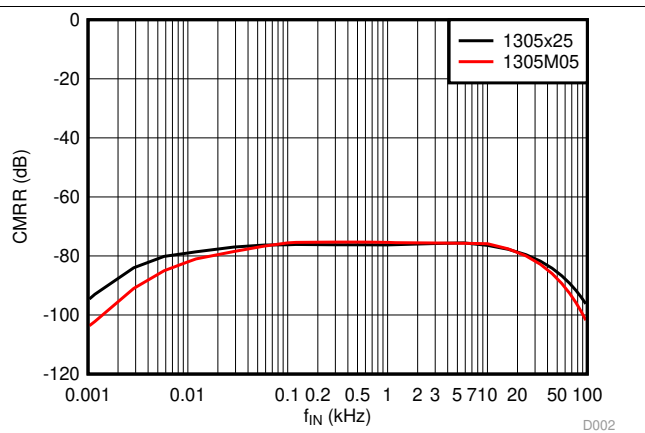

Figure 7. Common-Mode Rejection Ratio vs Input Signal Frequency

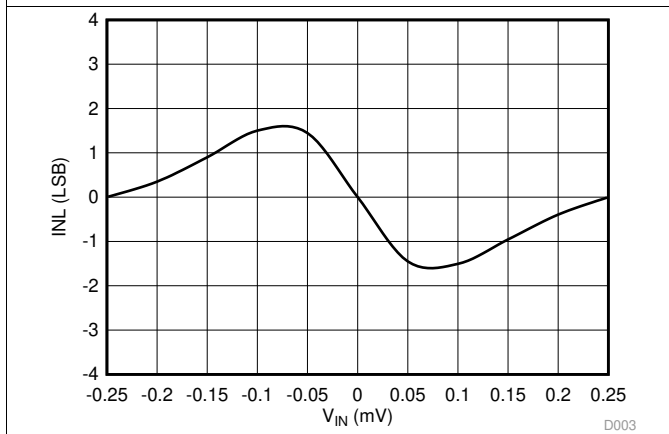

Figure 8. Integral Nonlinearity vs Input Signal Amplitude

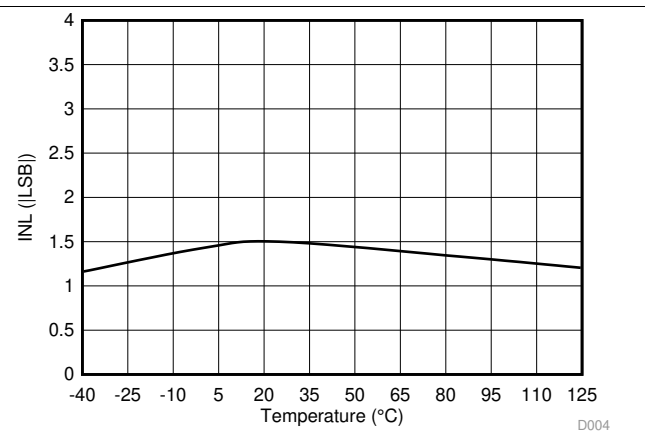

Figure 9. Integral Nonlinearity vs Temperature

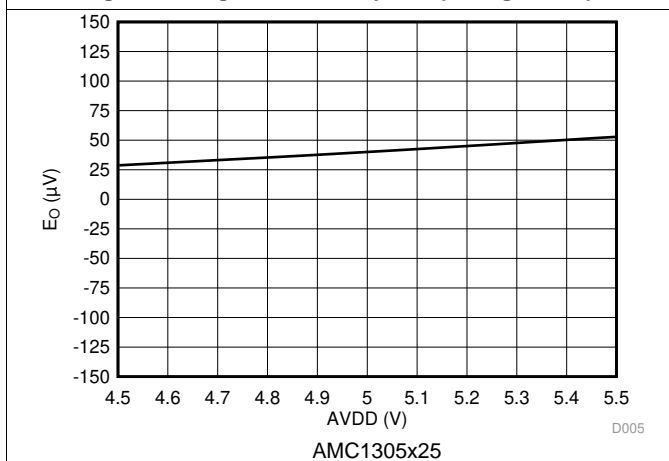

Figure 10. Offset Error vs High-Side Supply Voltage

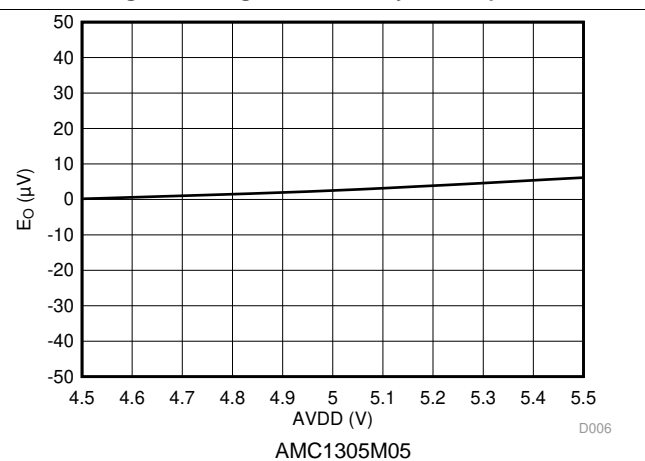

Figure 11. Offset Error vs High-Side Supply Voltage

Typical Characteristics (continued)

At $T_A = 25^\circ\text{C}$, $AVDD = 5.0\text{ V}$, $DVDD = 3.3\text{ V}$, $AINP = -250\text{ mV to }250\text{ mV}$, $AINN = 0\text{ V}$, $f_{CLKIN} = 20\text{ MHz}$, and sinc³ filter with OSR = 256, unless otherwise noted.

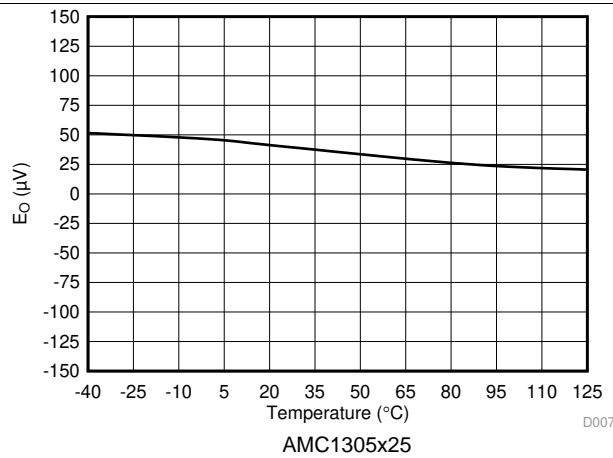

Figure 12. Offset Error vs Temperature

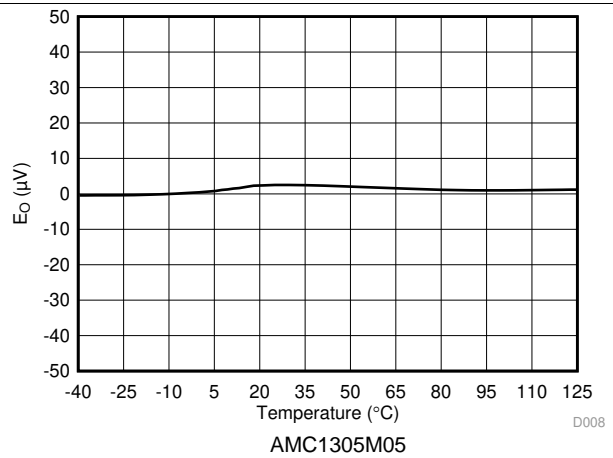

Figure 13. Offset Error vs Temperature

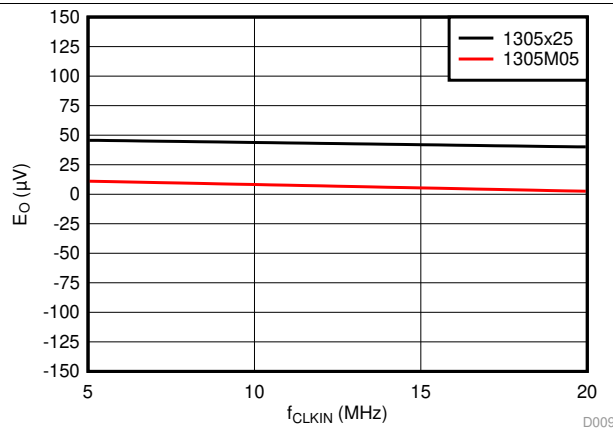

Figure 14. Offset Error vs Clock Frequency

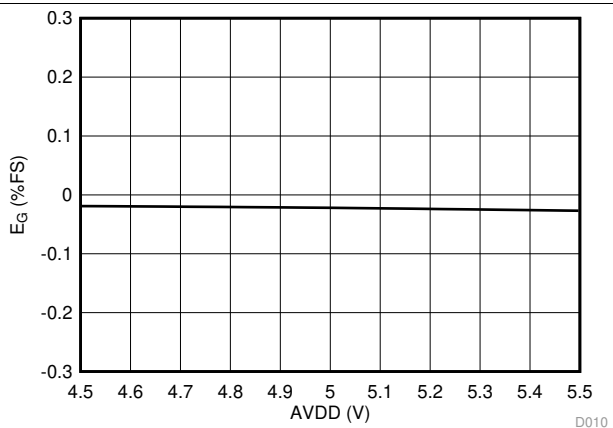

Figure 15. Gain Error vs High-Side Supply Voltage

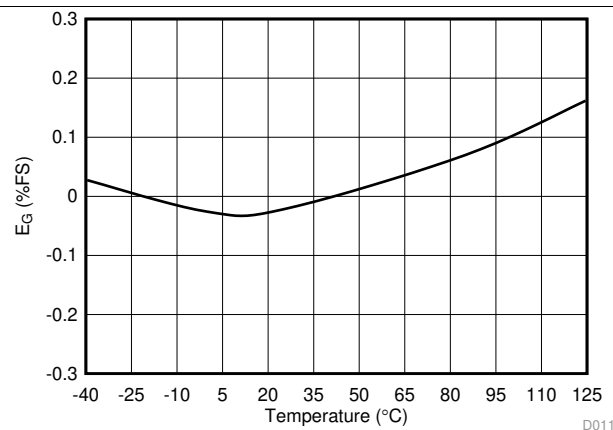

Figure 16. Gain Error vs Temperature

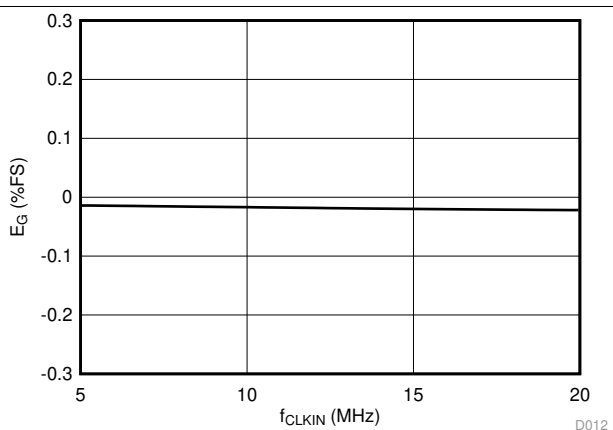

Figure 17. Gain Error vs Clock Frequency

Typical Characteristics (continued)

At $T_A = 25^\circ\text{C}$, $AV_{DD} = 5.0\text{ V}$, $DV_{DD} = 3.3\text{ V}$, $A_{INP} = -250\text{ mV}$ to 250 mV , $A_{INN} = 0\text{ V}$, $f_{CLKIN} = 20\text{ MHz}$, and sinc³ filter with OSR = 256, unless otherwise noted.

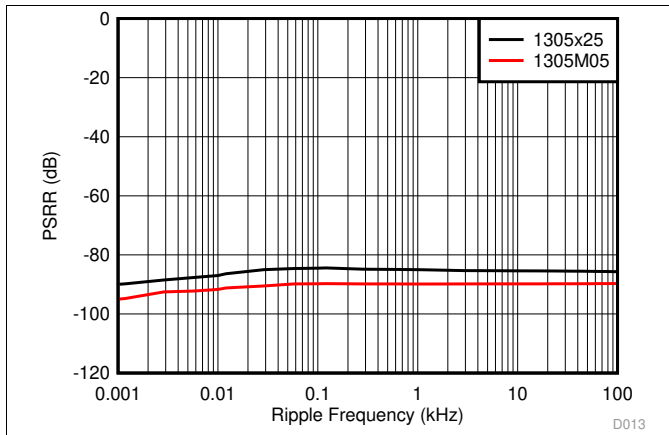

Figure 18. Power-Supply Rejection Ratio vs Ripple Frequency

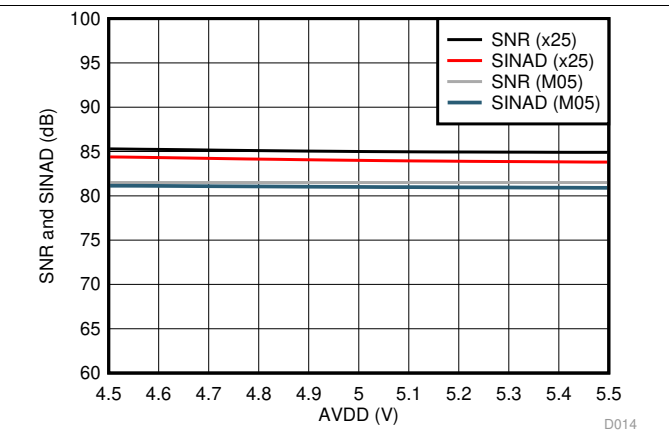

Figure 19. SNR and SINAD vs High-Side Supply Voltage

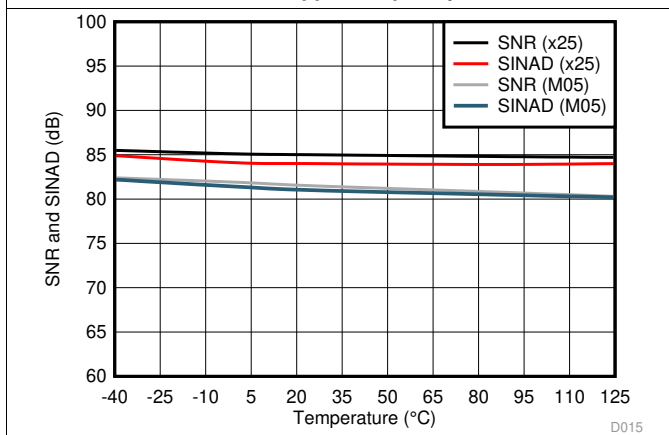

Figure 20. SNR and SINAD vs Temperature

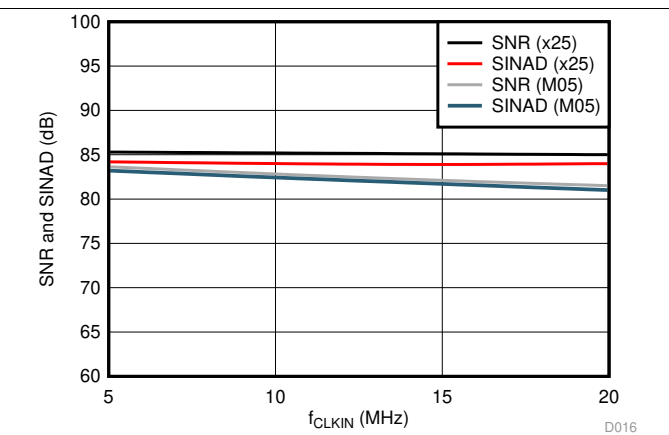

Figure 21. SNR and SINAD vs Clock Frequency

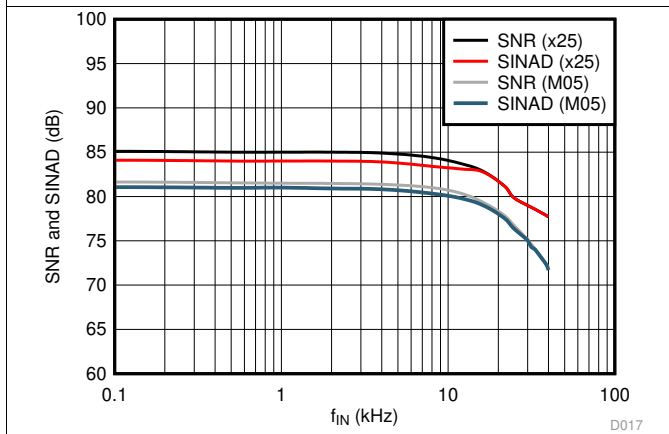

Figure 22. SNR and SINAD vs Input Signal Frequency

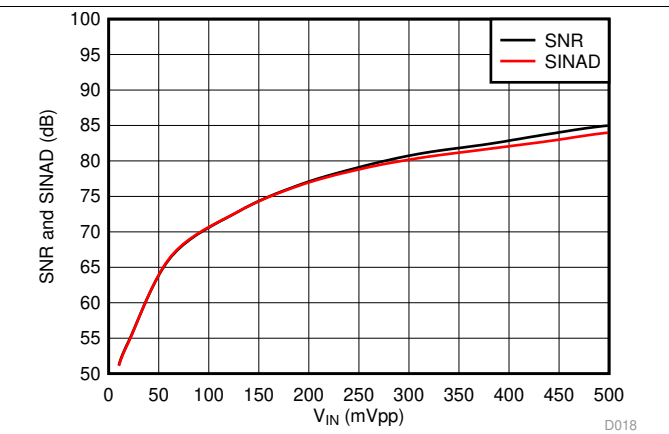

Figure 23. SNR and SINAD vs Input Signal Amplitude

Typical Characteristics (continued)

At $T_A = 25^\circ\text{C}$, $AV_{DD} = 5.0\text{ V}$, $DV_{DD} = 3.3\text{ V}$, $A_{INP} = -250\text{ mV to }250\text{ mV}$, $A_{INN} = 0\text{ V}$, $f_{CLKIN} = 20\text{ MHz}$, and sinc³ filter with OSR = 256, unless otherwise noted.

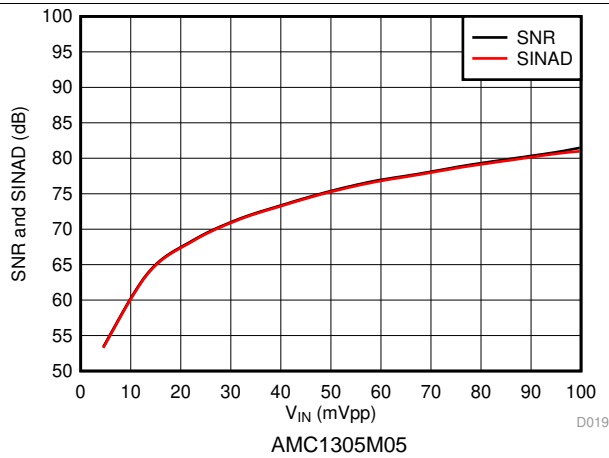

Figure 24. SNR and SINAD vs Input Signal Amplitude

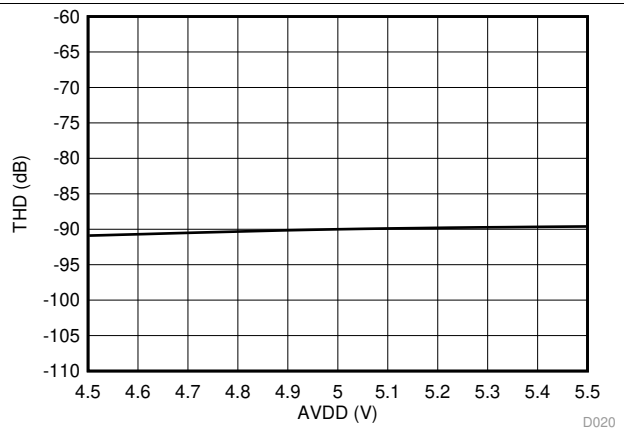

Figure 25. Total Harmonic Distortion vs High-Side Supply Voltage

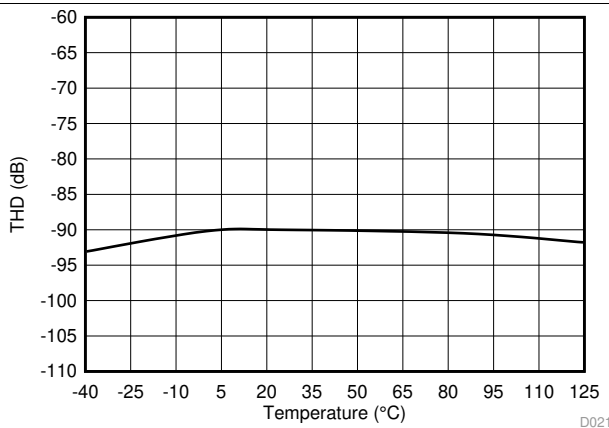

Figure 26. Total Harmonic Distortion vs Temperature

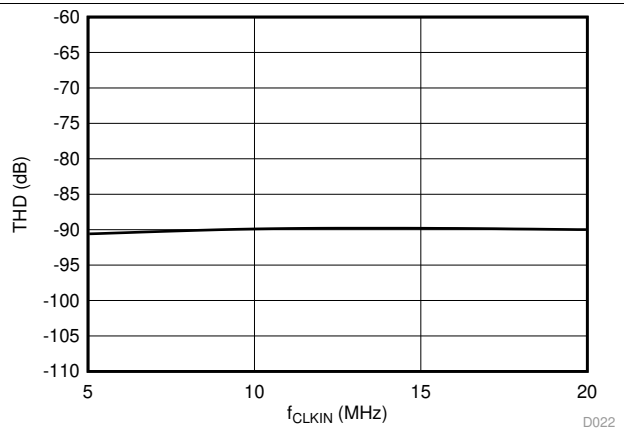

Figure 27. Total Harmonic Distortion vs Clock Frequency

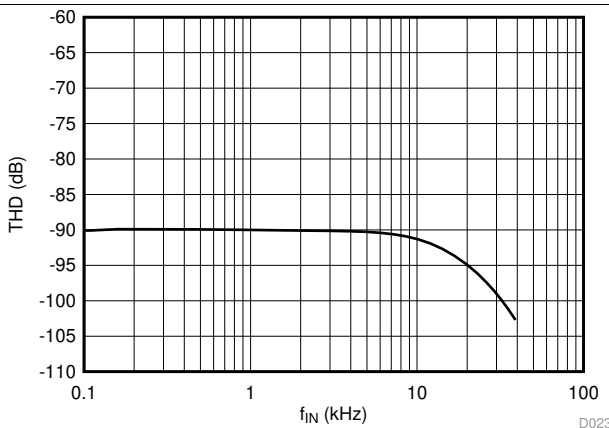

Figure 28. Total Harmonic Distortion vs Input Signal Frequency

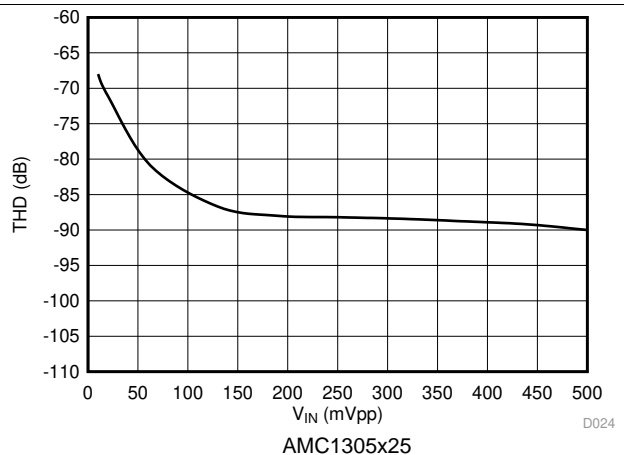

Figure 29. Total Harmonic Distortion vs Input Signal Amplitude

Typical Characteristics (continued)

At $T_A = 25^\circ\text{C}$, $AV_{DD} = 5.0\text{ V}$, $DV_{DD} = 3.3\text{ V}$, $A_{INP} = -250\text{ mV to }250\text{ mV}$, $A_{INN} = 0\text{ V}$, $f_{CLKIN} = 20\text{ MHz}$, and sinc³ filter with OSR = 256, unless otherwise noted.

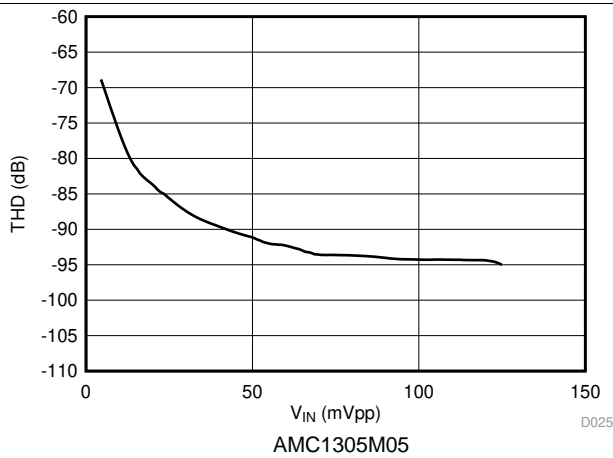

Figure 30. Total Harmonic Distortion vs Input Signal Amplitude

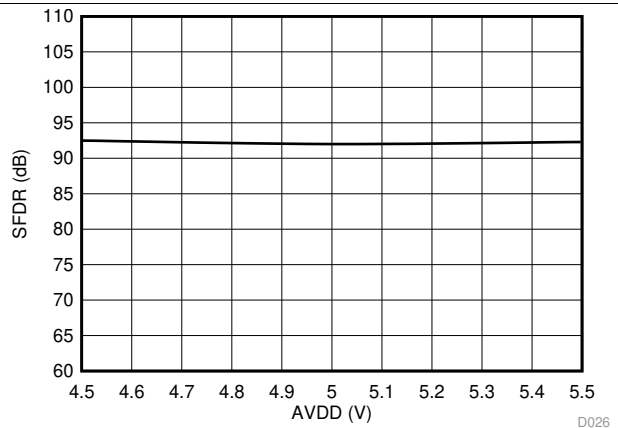

Figure 31. Spurious-Free Dynamic Range vs High-Side Supply Voltage

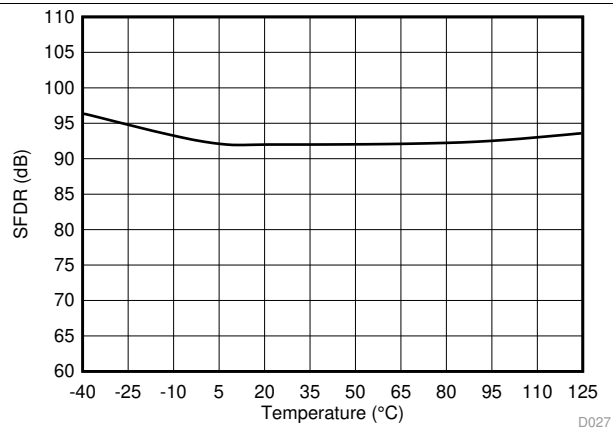

Figure 32. Spurious-Free Dynamic Range vs Temperature

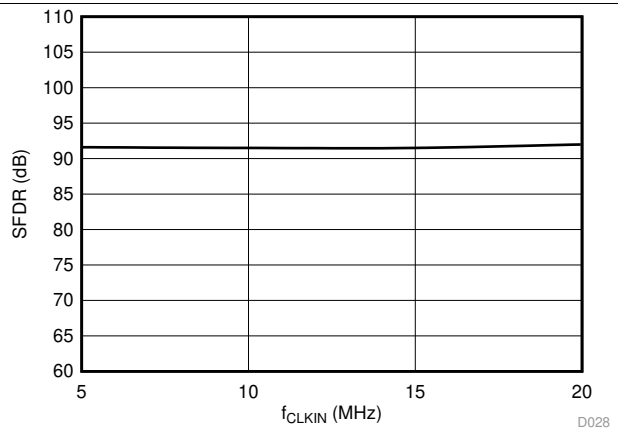

Figure 33. Spurious-Free Dynamic Range vs Clock Frequency

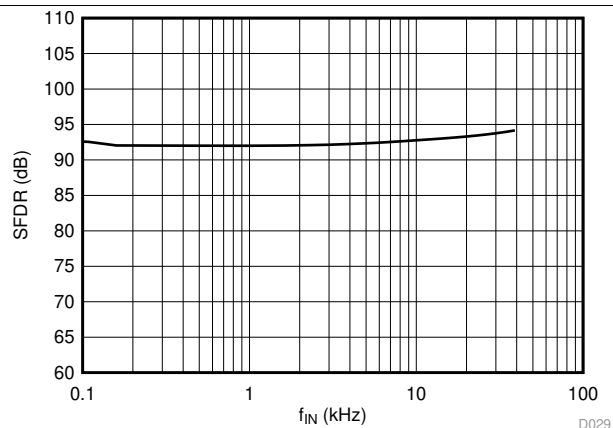

Figure 34. Spurious-Free Dynamic Range vs Input Signal Frequency

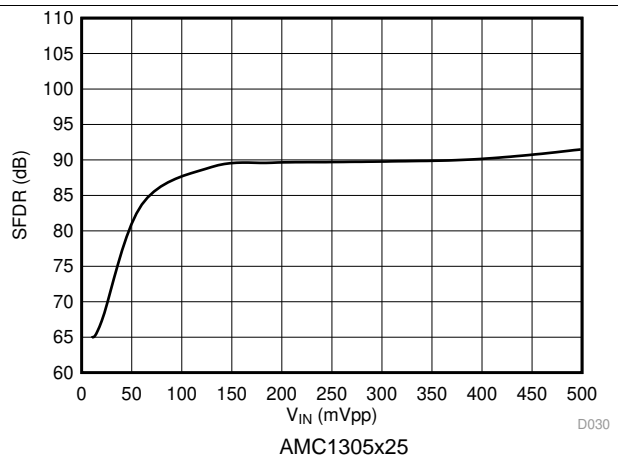

Figure 35. Spurious-Free Dynamic Range vs Input Signal Amplitude

Typical Characteristics (continued)

At $T_A = 25^\circ\text{C}$, $AV_{DD} = 5.0\text{ V}$, $DV_{DD} = 3.3\text{ V}$, $A_{INP} = -250\text{ mV to }250\text{ mV}$, $A_{INN} = 0\text{ V}$, $f_{CLKIN} = 20\text{ MHz}$, and sinc³ filter with OSR = 256, unless otherwise noted.

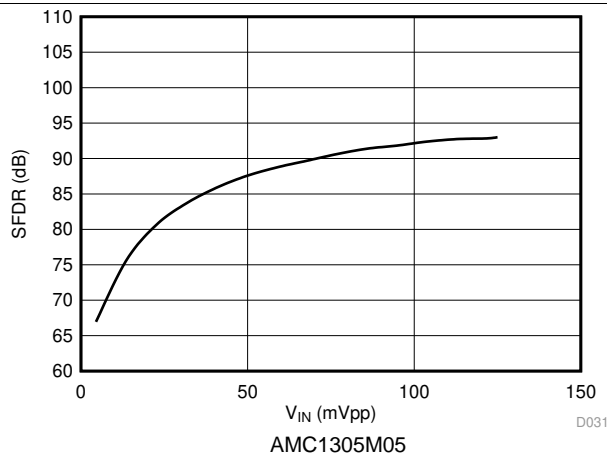

Figure 36. Spurious-Free Dynamic Range vs Input Signal Amplitude

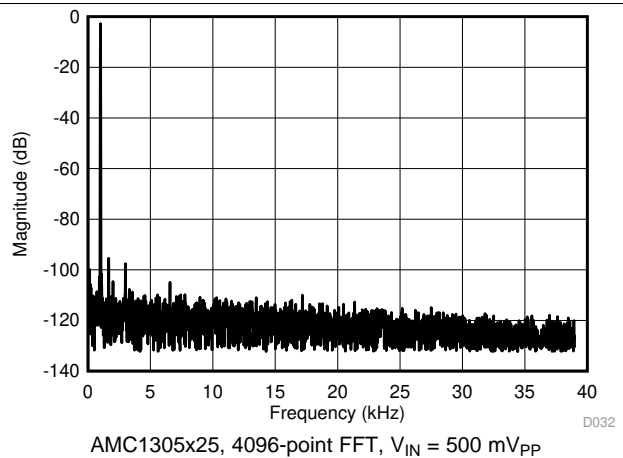

Figure 37. Frequency Spectrum with 1-kHz Input Signal

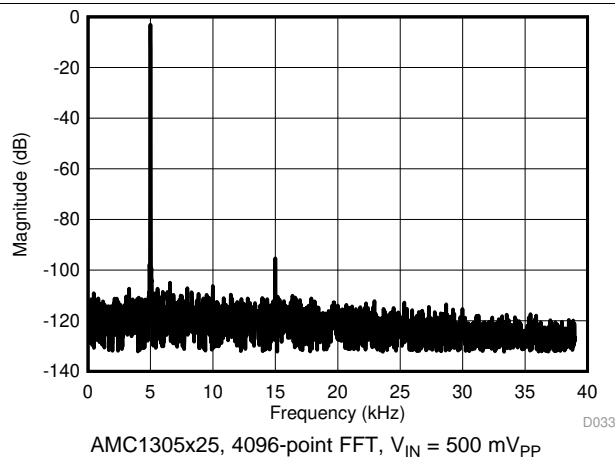

Figure 38. Frequency Spectrum with 5-kHz Input Signal

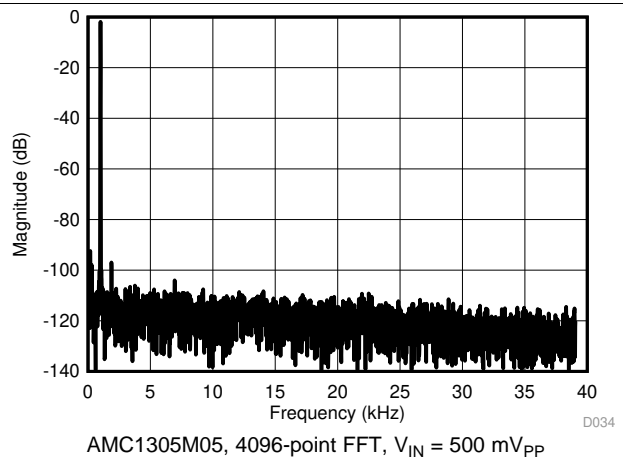

Figure 39. Frequency Spectrum with 1-kHz Input Signal

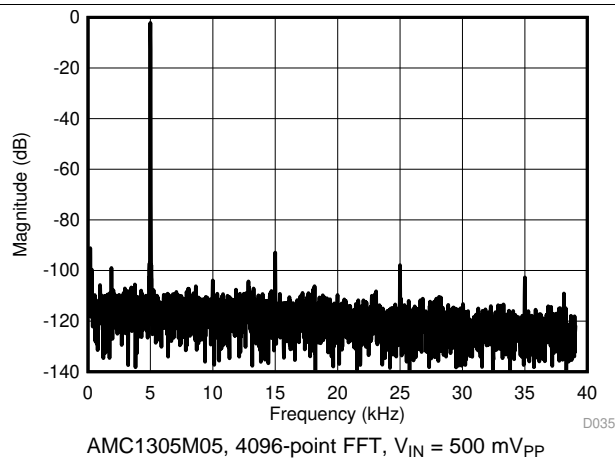

Figure 40. Frequency Spectrum with 5-kHz Input Signal

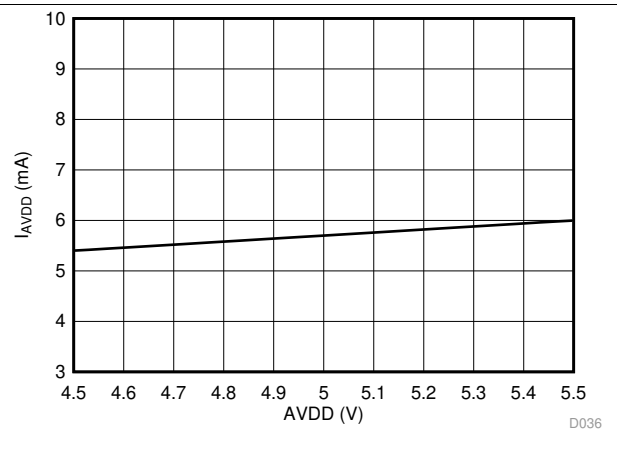

Figure 41. High-Side Supply Current vs High-Side Supply Voltage

Typical Characteristics (continued)

At $T_A = 25^\circ\text{C}$, $AVDD = 5.0\text{ V}$, $DVDD = 3.3\text{ V}$, $A\text{INP} = -250\text{ mV to }250\text{ mV}$, $A\text{INN} = 0\text{ V}$, $f_{\text{CLKIN}} = 20\text{ MHz}$, and sinc³ filter with OSR = 256, unless otherwise noted.

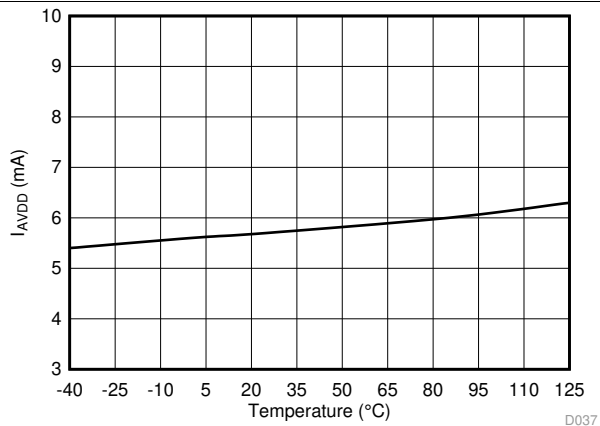

Figure 42. High-Side Supply Current vs Temperature

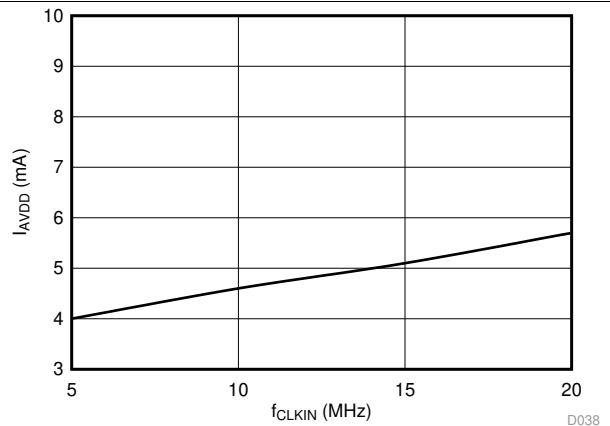

Figure 43. High-Side Supply Current vs Clock Frequency

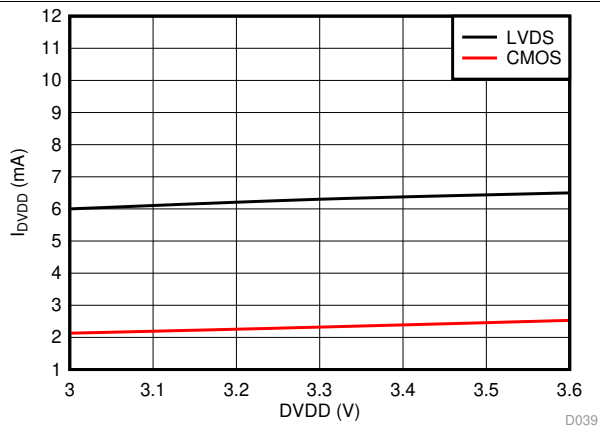

Figure 44. Controller-Side Supply Current vs Controller-Side Supply Voltage (3.3 V, nom)

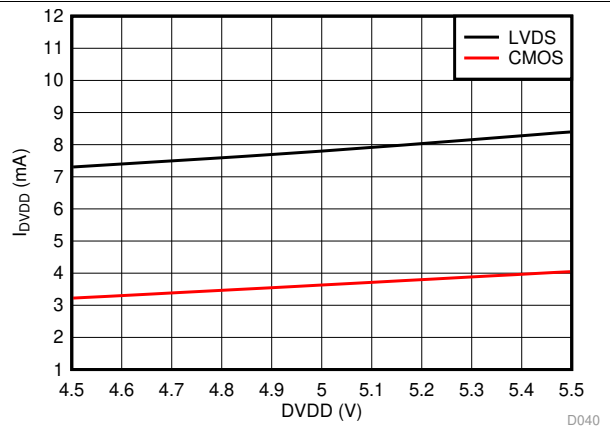

Figure 45. Controller-Side Supply Current vs Controller-Side Supply Voltage (5 V, nom)

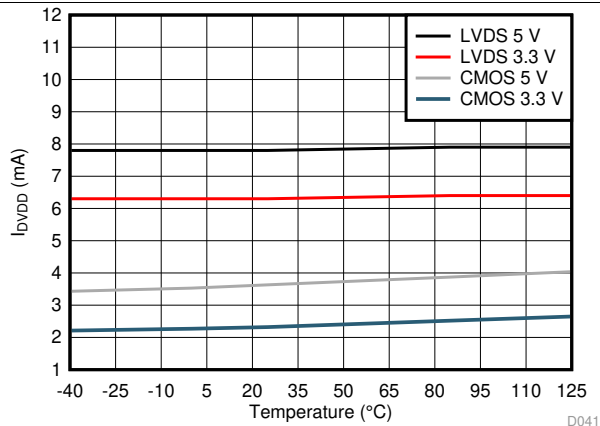

Figure 46. Controller-Side Supply Current vs Temperature

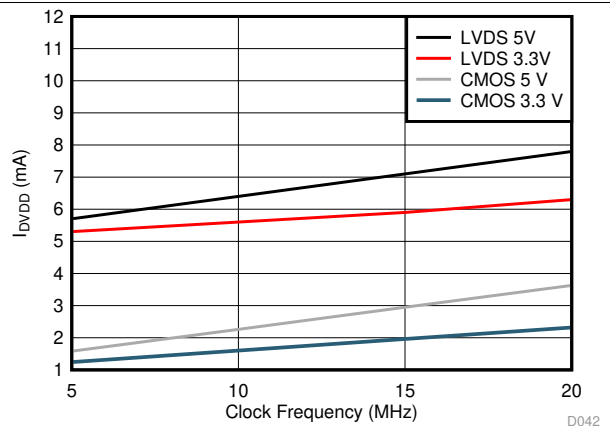

Figure 47. Controller-Side Supply Current vs Clock Frequency

8 Detailed Description

8.1 Overview

The differential analog input (AINP and AINN) of the AMC1305 is a fully-differential amplifier feeding the switched-capacitor input of a second-order delta-sigma ($\Delta\Sigma$) modulator stage that digitizes the input signal into a 1-bit output stream. The isolated data output (DOUT) of the converter provides a stream of digital ones and zeros synchronous to the externally-provided clock source at the CLKIN pin with a frequency in the range of 5 MHz to 20.1 MHz. The time average of this serial bit-stream output is proportional to the analog input voltage.

The [Functional Block Diagram](#) section shows a detailed block diagram of the AMC1305. The analog input range is tailored to directly accommodate a voltage drop across a shunt resistor used for current sensing. The SiO₂-based capacitive isolation barrier supports a high level of magnetic field immunity as described in the application report [ISO72x Digital Isolator Magnetic-Field Immunity](#) (SLLA181A), available for download at www.ti.com. The external clock input simplifies the synchronization of multiple current-sense channels on the system level. The extended frequency range of up to 20.1 MHz supports higher performance levels compared to other solutions available on the market.

8.2 Functional Block Diagram

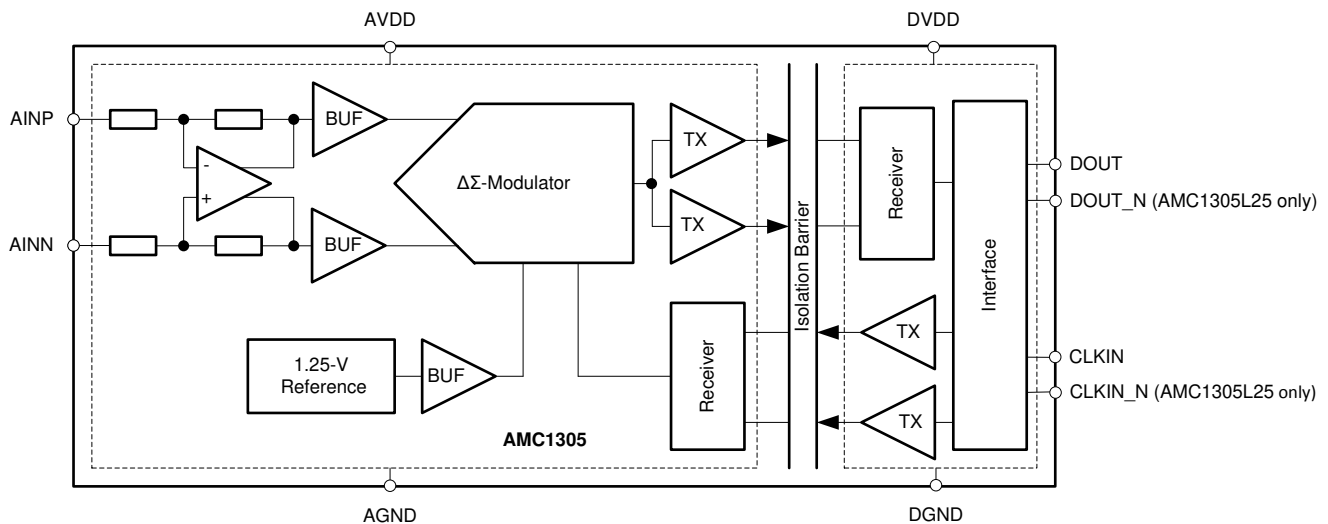

8.3 Feature Description

8.3.1 Analog Input

The AMC1305 incorporates front-end circuitry that contains a differential amplifier and sampling stage, followed by a $\Delta\Sigma$ modulator. The gain of the differential amplifier is set by internal precision resistors to a factor of 4 for devices with a specified input voltage range of ± 250 mV (for the AMC1305x25), or to a factor of 20 for devices with a ± 50 -mV input voltage range (for the AMC1305M05), resulting in a differential input impedance of 5 k Ω (for the AMC1305M05) or 25 k Ω (for the AMC1305x25).

Consider the input impedance of the AMC1305 in designs with high-impedance signal sources that can cause degradation of gain and offset specifications. The importance of this effect, however, depends on the desired system performance. Additionally, the input bias current caused by the internal common-mode voltage at the output of the differential amplifier causes an offset that depends on the actual amplitude of the input signal. See the *Isolated Voltage Sensing* section for more details on reducing these effects.

There are two restrictions on the analog input signals (AINP and AINN). First, if the input voltage exceeds the range of AGND – 6 V to AVDD + 0.5 V, the input current must be limited to 10 mA because the device input electrostatic discharge (ESD) protection diodes turn on. In addition, the linearity and noise performance of the device are ensured only when the differential analog input voltage remains within the specified linear full-scale range (FSR), that is ± 250 mV (for the AMC1305x25) or ± 50 mV (for the AMC1305M05), and within the specified input common-mode range.

8.3.2 Modulator

The modulator implemented in the AMC1305 is a second-order, switched-capacitor, feed-forward $\Delta\Sigma$ modulator, such as the one conceptualized in Figure 48. The analog input voltage V_{IN} and the output V_5 of the 1-bit digital-to-analog converter (DAC) are differentiated, providing an analog voltage V_1 at the input of the first integrator stage. The output of the first integrator feeds the input of the second integrator stage, resulting in output voltage V_3 that is differentiated with the input signal V_{IN} and the output of the first integrator V_2 . Depending on the polarity of the resulting voltage V_4 , the output of the comparator is changed. In this case, the 1-bit DAC responds on the next clock pulse by changing its analog output voltage V_5 , causing the integrators to progress in the opposite direction while forcing the value of the integrator output to track the average value of the input.

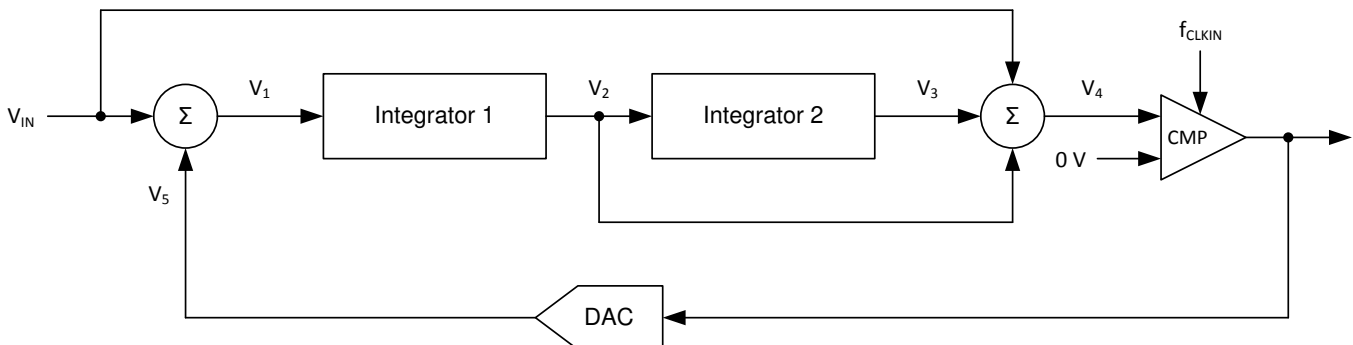

Figure 48. Block Diagram of a Second-Order Modulator

The modulator shifts the quantization noise to high frequencies; see Figure 49. Therefore, use a low-pass digital filter at the output of the device to increase overall performance. This filter is also used to convert from the 1-bit data stream at a high sampling rate into a higher-bit data word at a lower rate (decimation). TI's microcontroller family TMS320F2837x offers a suitable programmable, hardwired filter structure termed a *sigma-delta filter module* (SDFM) optimized for usage with the AMC1305 family. Also, SD24_B converters on the MSP430F677x microcontrollers offer a path to directly access the integrated sinc-filters, thus offering a system-level solution for multichannel isolated current sensing. An additional option is to use a suitable application-specific device (such as the AMC1210, a four-channel digital sinc-filter). Alternatively, a field-programmable gate array (FPGA) can be used to implement the digital filter.

Feature Description (continued)

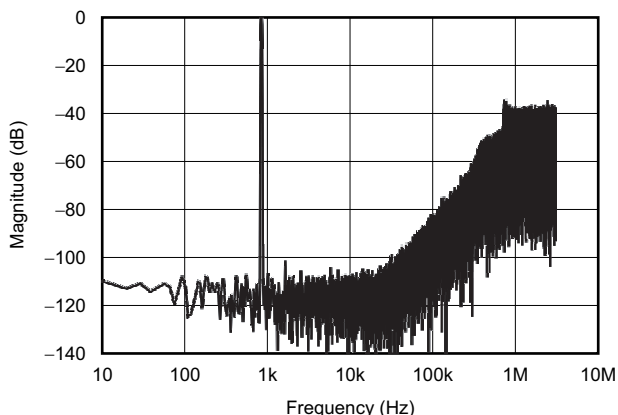

Figure 49. Quantization Noise Shaping

8.3.3 Digital Output

A differential input signal of 0 V ideally produces a stream of ones and zeros that are high 50% of the time. A differential input of 250 mV (for the AMC1305x25) or 50 mV (for the AMC1305M05) produces a stream of ones and zeros that are high 90% of the time. A differential input of –250 mV (–50 mV for the AMC1305M05) produces a stream of ones and zeros that are high 10% of the time. These input voltages are also the specified linear ranges of the different AMC1305 versions with performance as specified in this document. If the input voltage value exceeds these ranges, the output of the modulator shows non-linear behavior while the quantization noise increases. The output of the modulator would clip with a stream of only zeros with an input less than or equal to –312.5 mV (–62.5 mV for the AMC1305M05) or with a stream of only ones with an input greater than or equal to 312.5 mV (62.5 mV for the AMC1305M05). In this case, however, the AMC1305 generates a single 1 (if the input is at negative full-scale) or 0 every 128 clock cycles to indicate proper device function (see the [Fail-Safe Output](#) section for more details). The input voltage versus the output modulator signal is shown in [Figure 50](#).

The density of ones in the output bit-stream for any input voltage value (with the exception of a full-scale input signal as described in [Output Behavior in Case of Full-Scale Input](#)) can be calculated using [Equation 1](#):

$$\frac{V_{IN} + V_{Clipping}}{2 * V_{Clipping}} \quad (1)$$

The AMC1305 system clock is typically 20 MHz and is provided externally at the CLKIN pin. Data are synchronously provided at 20 MHz at the DOUT pin. Data change at the CLKIN falling edge. For more details, see the [Switching Characteristics](#) table.

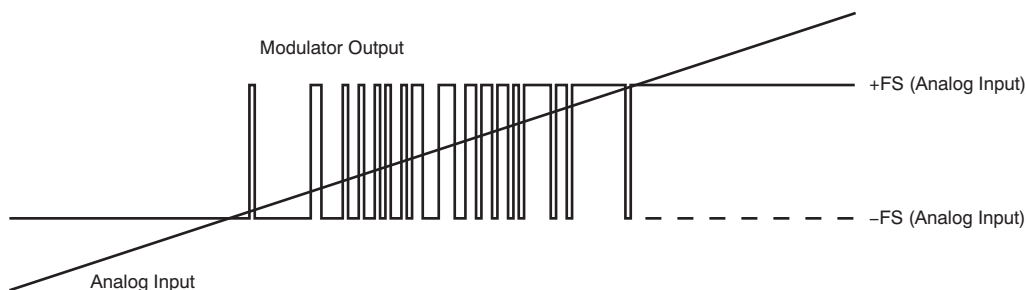

Figure 50. Analog Input versus AMC1305 Modulator Output

8.4 Device Functional Modes

8.4.1 Fail-Safe Output

In the case of a missing high-side supply voltage (AVDD), the output of a $\Delta\Sigma$ modulator is not defined and could cause a system malfunction. In systems with high safety requirements, this behavior is not acceptable. Therefore, the AMC1305 implements a fail-safe output function that ensures the device maintains its output level in case of a missing AVDD, as shown in Figure 51.

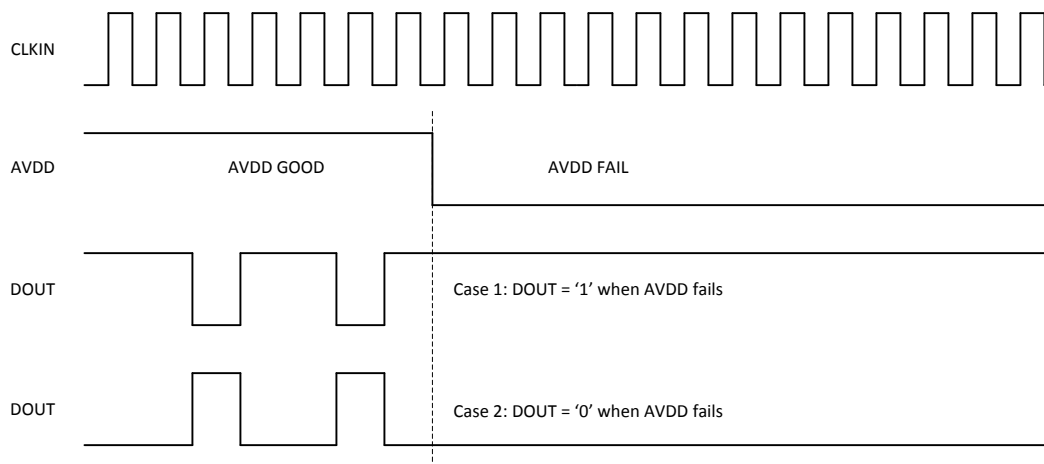

Figure 51. Fail-Safe Output of the AMC1305

8.4.2 Output Behavior in Case of Full-Scale Input

If a full-scale input signal is applied to the AMC1305 (that is, $V_{IN} \geq V_{Clipping}$), the device generates a single one or zero every 128 bits at DOUT, depending on the actual polarity of the signal being sensed, as shown in Figure 52. In this way, differentiating between a missing AVDD and a full-scale input signal is possible on the system level.

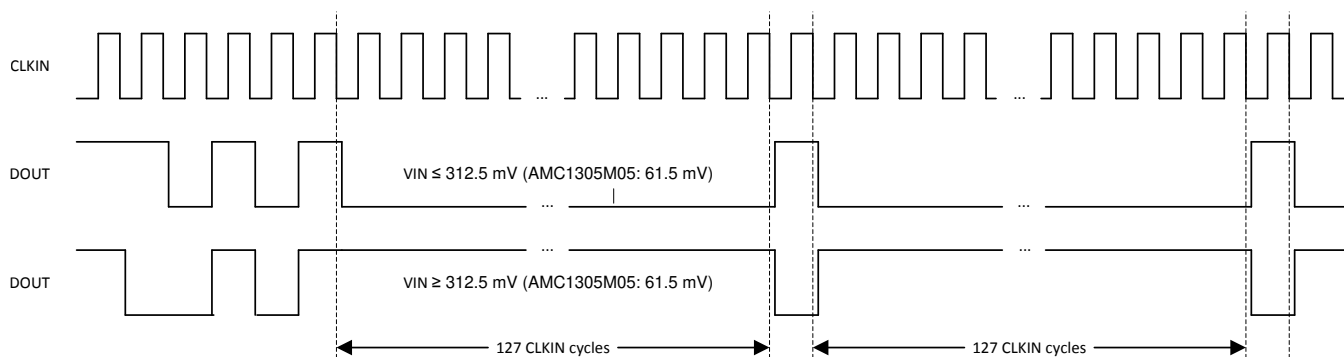

Figure 52. Overage Output of the AMC1305

9 Application and Implementation

NOTE

Information in the following applications sections is not part of the TI component specification, and TI does not warrant its accuracy or completeness. TI's customers are responsible for determining suitability of components for their purposes. Customers should validate and test their design implementation to confirm system functionality.

9.1 Application Information

9.1.1 Digital Filter Usage

The modulator generates a bit stream that is processed by a digital filter to obtain a digital word similar to a conversion result of a conventional analog-to-digital converter (ADC). A very simple filter, built with minimal effort and hardware, is a sinc³-type filter, as shown in [Equation 2](#):

$$H(z) = \left(\frac{1 - z^{-OSR}}{1 - z^{-1}} \right)^3 \quad (2)$$

This filter provides the best output performance at the lowest hardware size (count of digital gates) for a second-order modulator. All the characterization in this document is also done with a sinc³ filter with an over-sampling ratio (OSR) of 256 and an output word width of 16 bits.

$$SNR = 1.76dB + 6.02dB * ENOB \quad (3)$$

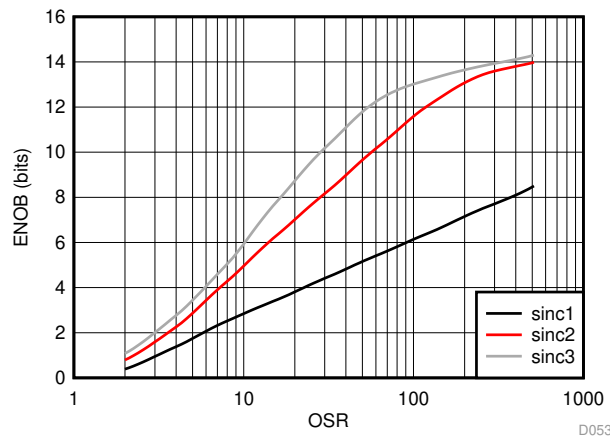

Figure 53. Measured Effective Number of Bits versus Oversampling Ratio

An example code for an implementation of a sinc³ filter in an FPGA, see the application note [Combining ADS1202 with FPGA Digital Filter for Current Measurement in Motor Control Applications \(SBAA094\)](#), available for download at www.ti.com.

9.2 Typical Applications

9.2.1 Frequency Inverter Application

Because to their high ac and dc performance, isolated $\Delta\Sigma$ modulators are being widely used in new generation frequency inverter designs. Frequency inverters are critical parts of industrial motor drives, photovoltaic inverters (string and central inverters), uninterruptible power supplies (UPS), electrical and hybrid electrical vehicles, and other industrial applications. The input structure of the AMC1305 is optimized for use with low-impedance shunt resistors and is therefore tailored for isolated current sensing using shunts.

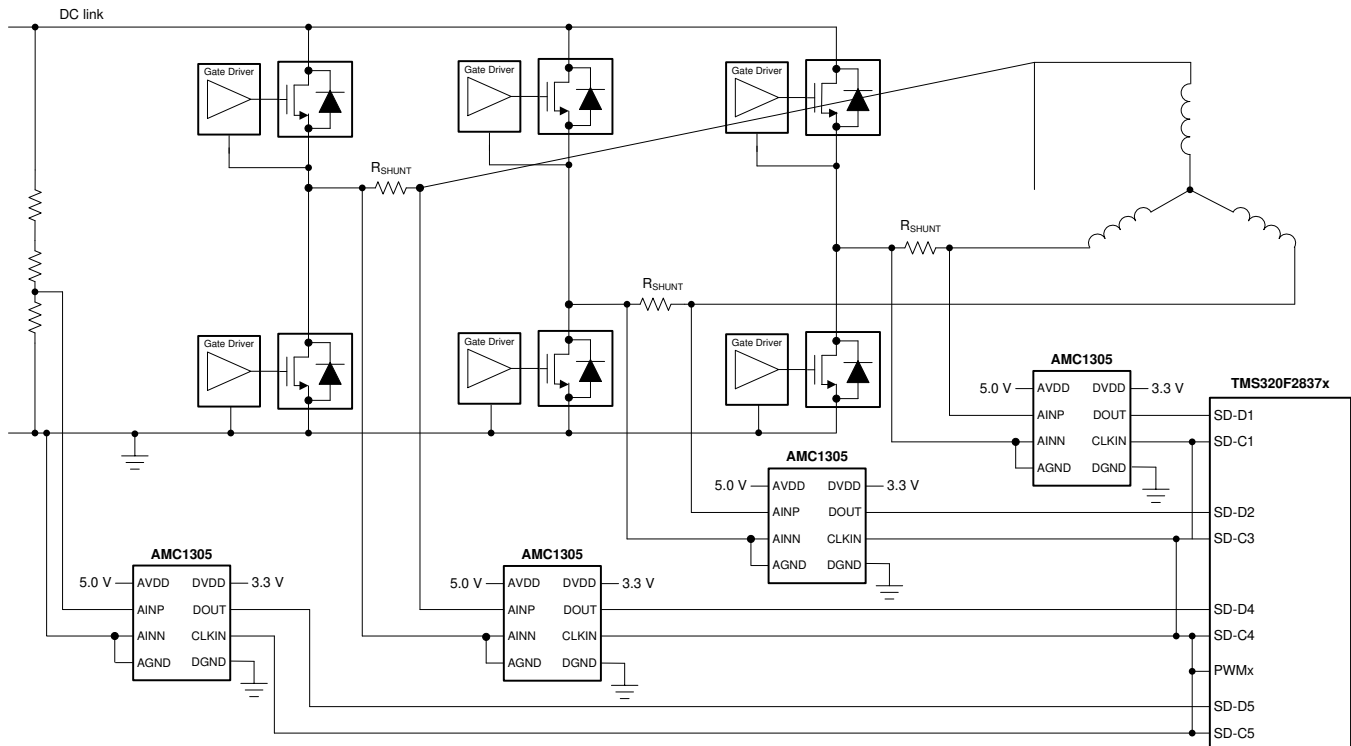

Figure 54. The AMC1305 in a Frequency Inverter Application

9.2.1.1 Design Requirements

A typical operation of the device in a frequency inverter application is shown in Figure 54. When the inverter stage is part of a motor drive system, measurement of the motor phase current is done via the shunt resistors (R_{SHUNT}). Depending on the system design, either all three or only two phase currents are sensed.

In this example, an additional fourth AMC1305 is used to support isolated voltage sensing of the dc link. This high voltage is reduced using a high-impedance resistive divider before being sensed by the device across a smaller resistor. The value of this resistor can degrade the performance of the measurement, as described in the [Isolated Voltage Sensing](#) section.

9.2.1.2 Detailed Design Procedure

The usually recommended RC filter in front of a $\Delta\Sigma$ modulator to improve signal-to-noise performance of the signal path, is not required for the AMC1305. By design, the input bandwidth of the analog front-end of the device is limited to 1 MHz.

For modulator output bit-stream filtering, a device from TI's [TMS320F2837x](#) family of dual-core MCUs is recommended. This family supports up to eight channels of dedicated hardwired filter structures that significantly simplify system level design by offering two filtering paths per channel: one providing high accuracy results for the control loop and one fast response path for overcurrent detection.

Typical Applications (continued)

9.2.1.3 Application Curve

In motor control applications, a very fast response time for overcurrent detection is required. The time for fully settling the filter in case of a step-signal at the input of the modulator depends on its order; that is, a sinc³ filter requires three data updates for full settling (with $f_{DATA} = f_{CLK} / OSR$). Therefore, for overcurrent protection, filter types other than sinc³ can be a better choice; an alternative is the sinc² filter. Figure 55 compares the settling times of different filter orders.

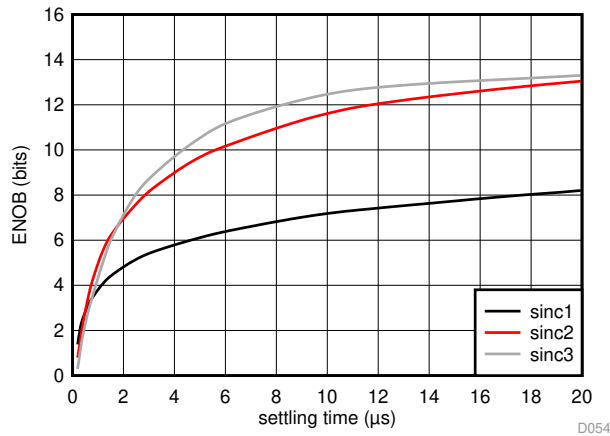

Figure 55. Measured Effective Number of Bits versus Settling Time

The delay time of the sinc filter with a continuous signal is half of its settling time.

Typical Applications (continued)

9.2.2 Isolated Voltage Sensing

The AMC1305 is optimized for usage in current-sensing applications using low-impedance shunts. However, the device can also be used in isolated voltage-sensing applications if the impact of the (usually higher) impedance of the resistor used in this case is considered.

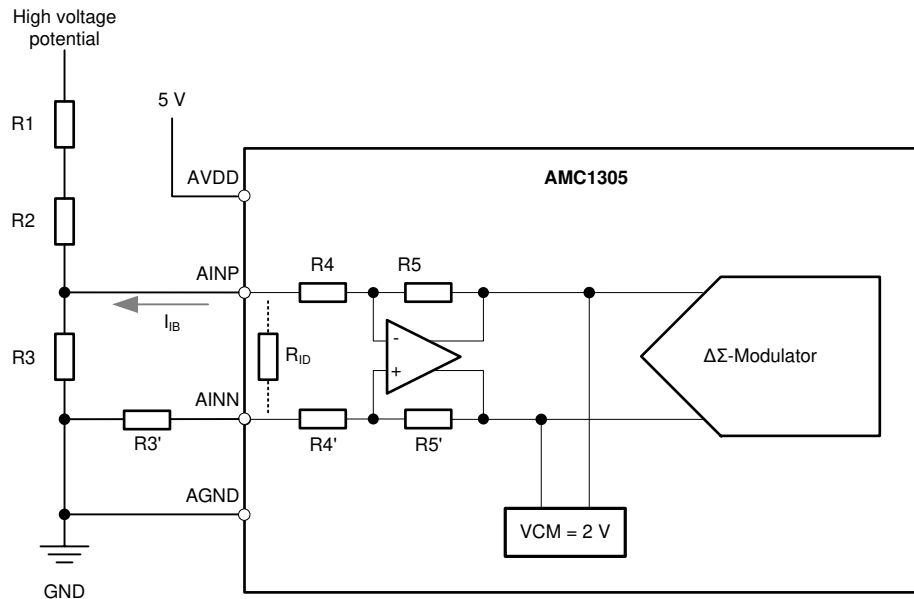

Figure 56. Using AMC1305 for Isolated Voltage Sensing

9.2.2.1 Design Requirements

Figure 56 shows a simplified circuit typically used in high-voltage sensing applications. The high impedance resistors (R1 and R2) are used as voltage dividers and dominate the current value definition. The resistance of the sensing resistor R3 is chosen to meet the input voltage range of the AMC1305. This resistor and the differential input impedance of the device (the AMC1305x25 is 25 kΩ, the AMC1305M05 is 5 kΩ) also create a voltage divider that results in an additional gain error. With the assumption of R1, R2, and R_{IN} having a considerably higher value than R3, the resulting total gain error can be estimated using Equation 4, with E_G being the gain error of the AMC1305.

$$|E_{Tot}| = |E_G| + \frac{R_3}{R_{IN}} \quad (4)$$

This gain error can be easily minimized during the initial system level gain calibration procedure.

9.2.2.2 Detailed Design Procedure

As indicated in Figure 56, the output of the integrated differential amplifier is internally biased to a common-mode voltage of 2 V. This voltage results in a bias current I_B through the resistive network R4 and R5 (or R4' and R5') used for setting the gain of the amplifier. The value range of this current is specified in the Electrical Characteristics table. This bias current generates additional offset error that depends on the value of the resistor R3. Because the value of this bias current depends on the actual common-mode amplitude of the input signal (as shown in Figure 57), the initial system offset calibration does not minimize its effect. Therefore, in systems with high accuracy requirements TI recommends using a series resistor at the negative input (AINN) of the AMC1305 with a value equal to the shunt resistor R3 (that is R3' = R3 in Figure 56) to eliminate the effect of the bias current.

Typical Applications (continued)

This additional series resistor (R3') influences the gain error of the circuit. The effect can be calculated using Equation 5 with R5 = R5' = 50 kΩ and R4 = R4' = 2.5 kΩ (for the AMC1305M05) or 12.5 kΩ (for the AMC1305x25).

$$E_G(\%) = \left(1 - \frac{R4}{R4' + R3'} \right) * 100\% \tag{5}$$

9.2.2.3 Application Curve

Figure 57 shows the dependency of the input bias current on the common-mode voltage at the input of the AMC1305.

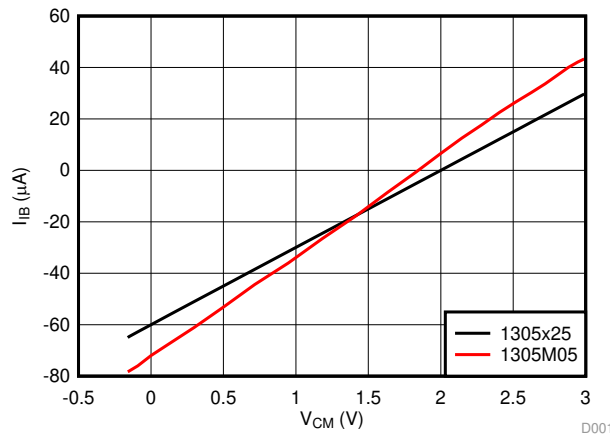

Figure 57. Input Current vs Input Common-Mode Voltage

11 Layout

11.1 Layout Guidelines

A layout recommendation showing the critical placement of the decoupling capacitors (as close as possible to the AMC1305) and placement of the other components required by the device is shown in Figure 59.

For the AMC1305L25 version, place the 100-Ω termination resistor as close as possible to the CLKIN, CLKIN_N inputs of the device to achieve highest signal integrity. If not integrated, an additional termination resistor is required as close as possible to the LVDS data inputs of the MCU or filter device; see Figure 60.

11.2 Layout Examples

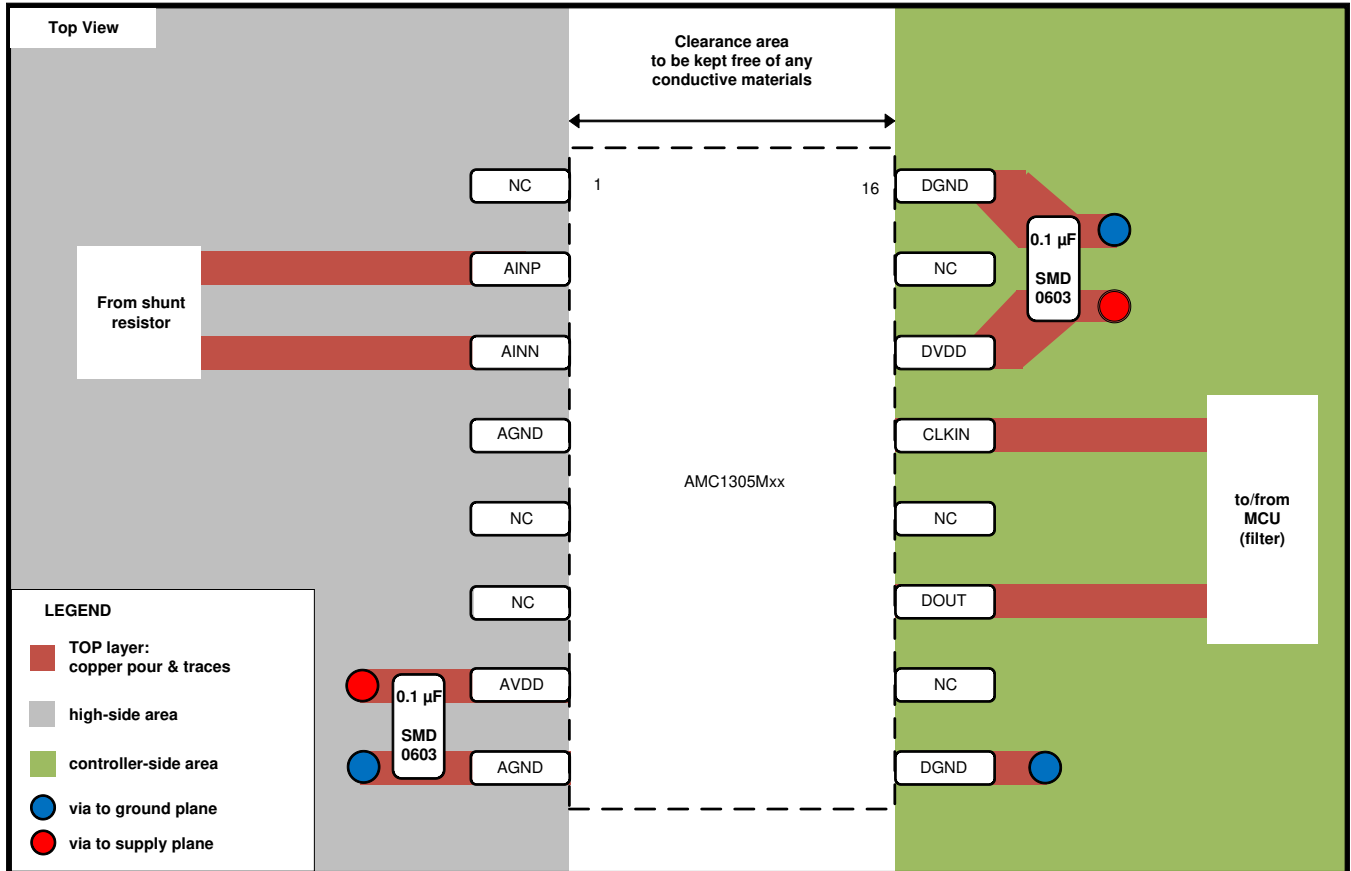

Figure 59. Recommended Layout of the AMC1305Mx

Layout Examples (continued)

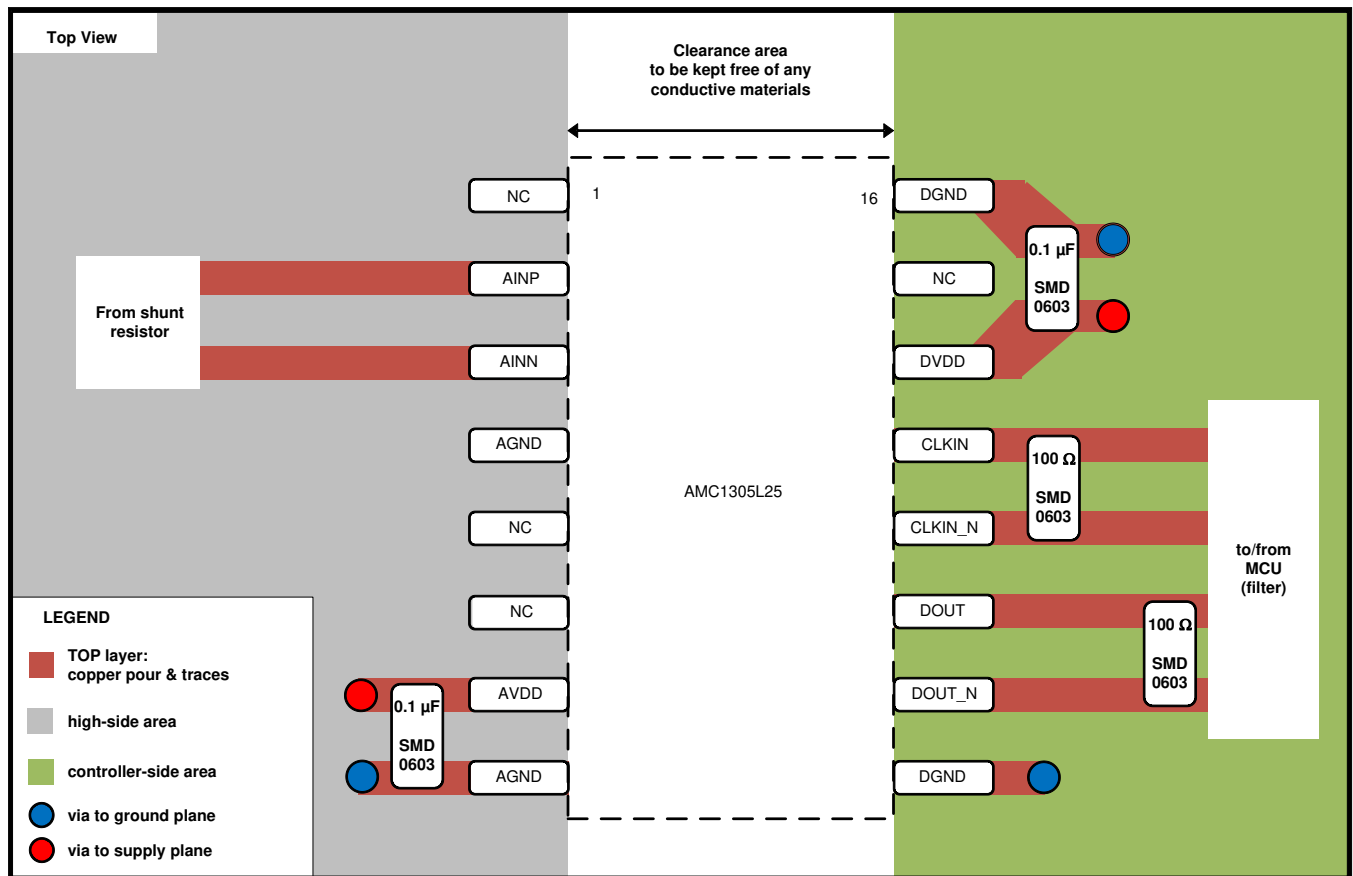

Figure 60. Recommended Layout of the AMC1305L25

12 Device and Documentation Support

12.1 Documentation Support

12.1.1 Related Documentation

For related documentation see the following:

- Texas Instruments, [Isolation Glossary application report](#)
- Texas Instruments, [ISO72x Digital Isolator Magnetic-Field Immunity application report](#)
- Texas Instruments, [Combining ADS1202 with FPGA Digital Filter for Current Measurement in Motor Control Applications application report](#)
- Texas Instruments, [LM117, LM317-N Wide Temperature Three-Pin Adjustable Regulator data sheet](#)
- Texas Instruments, [TMS320F2837xD Dual-Core Delfino™ Microcontrollers data sheet](#)
- Texas Instruments, [MSP430F677x Polyphase Metering SoCs data sheet](#)
- Texas Instruments, [AMC1210 Quad Digital Filter for 2nd-Order Delta-Sigma Modulator data sheet](#)

12.2 Related Links

The table below lists quick access links. Categories include technical documents, support and community resources, tools and software, and quick access to order now.

Table 1. Related Links

PARTS	PRODUCT FOLDER	ORDER NOW	TECHNICAL DOCUMENTS	TOOLS & SOFTWARE	SUPPORT & COMMUNITY
AMC1305L25	Click here	Click here	Click here	Click here	Click here
AMC1305M05	Click here	Click here	Click here	Click here	Click here
AMC1305M25	Click here	Click here	Click here	Click here	Click here

12.3 Receiving Notification of Documentation Updates

To receive notification of documentation updates, navigate to the device product folder on ti.com. In the upper right corner, click on *Alert me* to register and receive a weekly digest of any product information that has changed. For change details, review the revision history included in any revised document.

12.4 Support Resources

TI E2E™ [support forums](#) are an engineer's go-to source for fast, verified answers and design help — straight from the experts. Search existing answers or ask your own question to get the quick design help you need.

Linked content is provided "AS IS" by the respective contributors. They do not constitute TI specifications and do not necessarily reflect TI's views; see TI's [Terms of Use](#).

12.5 Trademarks

E2E is a trademark of Texas Instruments.

All other trademarks are the property of their respective owners.

12.6 Electrostatic Discharge Caution



This integrated circuit can be damaged by ESD. Texas Instruments recommends that all integrated circuits be handled with appropriate precautions. Failure to observe proper handling and installation procedures can cause damage.

ESD damage can range from subtle performance degradation to complete device failure. Precision integrated circuits may be more susceptible to damage because very small parametric changes could cause the device not to meet its published specifications.

12.7 Glossary

[SLYZ022](#) — *TI Glossary*.

This glossary lists and explains terms, acronyms, and definitions.

13 Mechanical, Packaging, and Orderable Information

The following pages include mechanical, packaging, and orderable information. This information is the most current data available for the designated devices. This data is subject to change without notice and revision of this document. For browser-based versions of this data sheet, refer to the left-hand navigation.

PACKAGING INFORMATION

Orderable Device	Status (1)	Package Type	Package Drawing	Pins	Package Qty	Eco Plan (2)	Lead/Ball Finish (6)	MSL Peak Temp (3)	Op Temp (°C)	Device Marking (4/5)	Samples
AMC1305L25DW	ACTIVE	SOIC	DW	16	40	Green (RoHS & no Sb/Br)	NIPDAU	Level-3-260C-168 HR	-40 to 125	AMC1305L25	Samples
AMC1305L25DWR	ACTIVE	SOIC	DW	16	2000	Green (RoHS & no Sb/Br)	NIPDAU	Level-3-260C-168 HR	-40 to 125	AMC1305L25	Samples
AMC1305M05DW	ACTIVE	SOIC	DW	16	40	Green (RoHS & no Sb/Br)	NIPDAU	Level-3-260C-168 HR	-40 to 125	AMC1305M05	Samples
AMC1305M05DWR	ACTIVE	SOIC	DW	16	2000	Green (RoHS & no Sb/Br)	NIPDAU	Level-3-260C-168 HR	-40 to 125	AMC1305M05	Samples
AMC1305M25DW	ACTIVE	SOIC	DW	16	40	Green (RoHS & no Sb/Br)	NIPDAU	Level-3-260C-168 HR	-40 to 125	AMC1305M25	Samples
AMC1305M25DWR	ACTIVE	SOIC	DW	16	2000	Green (RoHS & no Sb/Br)	NIPDAU	Level-3-260C-168 HR	-40 to 125	AMC1305M25	Samples

(1) The marketing status values are defined as follows:

ACTIVE: Product device recommended for new designs.

LIFEBUY: TI has announced that the device will be discontinued, and a lifetime-buy period is in effect.

NRND: Not recommended for new designs. Device is in production to support existing customers, but TI does not recommend using this part in a new design.

PREVIEW: Device has been announced but is not in production. Samples may or may not be available.

OBSOLETE: TI has discontinued the production of the device.

(2) **RoHS:** TI defines "RoHS" to mean semiconductor products that are compliant with the current EU RoHS requirements for all 10 RoHS substances, including the requirement that RoHS substance do not exceed 0.1% by weight in homogeneous materials. Where designed to be soldered at high temperatures, "RoHS" products are suitable for use in specified lead-free processes. TI may reference these types of products as "Pb-Free".

RoHS Exempt: TI defines "RoHS Exempt" to mean products that contain lead but are compliant with EU RoHS pursuant to a specific EU RoHS exemption.

Green: TI defines "Green" to mean the content of Chlorine (Cl) and Bromine (Br) based flame retardants meet JS709B low halogen requirements of <=1000ppm threshold. Antimony trioxide based flame retardants must also meet the <=1000ppm threshold requirement.

(3) MSL, Peak Temp. - The Moisture Sensitivity Level rating according to the JEDEC industry standard classifications, and peak solder temperature.

(4) There may be additional marking, which relates to the logo, the lot trace code information, or the environmental category on the device.

(5) Multiple Device Markings will be inside parentheses. Only one Device Marking contained in parentheses and separated by a "~" will appear on a device. If a line is indented then it is a continuation of the previous line and the two combined represent the entire Device Marking for that device.

⁽⁶⁾ Lead/Ball Finish - Orderable Devices may have multiple material finish options. Finish options are separated by a vertical ruled line. Lead/Ball Finish values may wrap to two lines if the finish value exceeds the maximum column width.

Important Information and Disclaimer:The information provided on this page represents TI's knowledge and belief as of the date that it is provided. TI bases its knowledge and belief on information provided by third parties, and makes no representation or warranty as to the accuracy of such information. Efforts are underway to better integrate information from third parties. TI has taken and continues to take reasonable steps to provide representative and accurate information but may not have conducted destructive testing or chemical analysis on incoming materials and chemicals. TI and TI suppliers consider certain information to be proprietary, and thus CAS numbers and other limited information may not be available for release.

In no event shall TI's liability arising out of such information exceed the total purchase price of the TI part(s) at issue in this document sold by TI to Customer on an annual basis.

OTHER QUALIFIED VERSIONS OF AMC1305L25, AMC1305M05, AMC1305M25 :

- Automotive: [AMC1305L25-Q1](#), [AMC1305M05-Q1](#), [AMC1305M25-Q1](#)

NOTE: Qualified Version Definitions:

- Automotive - Q100 devices qualified for high-reliability automotive applications targeting zero defects

TAPE AND REEL INFORMATION

QUADRANT ASSIGNMENTS FOR PIN 1 ORIENTATION IN TAPE

*All dimensions are nominal

Device	Package Type	Package Drawing	Pins	SPQ	Reel Diameter (mm)	Reel Width W1 (mm)	A0 (mm)	B0 (mm)	K0 (mm)	P1 (mm)	W (mm)	Pin1 Quadrant
AMC1305L25DWR	SOIC	DW	16	2000	330.0	16.4	10.75	10.7	2.7	12.0	16.0	Q1
AMC1305M05DWR	SOIC	DW	16	2000	330.0	16.4	10.75	10.7	2.7	12.0	16.0	Q1
AMC1305M25DWR	SOIC	DW	16	2000	330.0	16.4	10.75	10.7	2.7	12.0	16.0	Q1

TAPE AND REEL BOX DIMENSIONS

*All dimensions are nominal

Device	Package Type	Package Drawing	Pins	SPQ	Length (mm)	Width (mm)	Height (mm)
AMC1305L25DWR	SOIC	DW	16	2000	350.0	350.0	43.0
AMC1305M05DWR	SOIC	DW	16	2000	350.0	350.0	43.0
AMC1305M25DWR	SOIC	DW	16	2000	350.0	350.0	43.0

GENERIC PACKAGE VIEW

DW 16

SOIC - 2.65 mm max height

7.5 x 10.3, 1.27 mm pitch

SMALL OUTLINE INTEGRATED CIRCUIT

This image is a representation of the package family, actual package may vary.
Refer to the product data sheet for package details.



4224780/A



DW0016B

PACKAGE OUTLINE SOIC - 2.65 mm max height

SOIC



4221009/B 07/2016

NOTES:

1. All linear dimensions are in millimeters. Dimensions in parenthesis are for reference only. Dimensioning and tolerancing per ASME Y14.5M.
2. This drawing is subject to change without notice.
3. This dimension does not include mold flash, protrusions, or gate burrs. Mold flash, protrusions, or gate burrs shall not exceed 0.15 mm, per side.
4. This dimension does not include interlead flash. Interlead flash shall not exceed 0.25 mm, per side.
5. Reference JEDEC registration MS-013.

EXAMPLE BOARD LAYOUT

DW0016B

SOIC - 2.65 mm max height

SOIC



LAND PATTERN EXAMPLE
SCALE:4X



SOLDER MASK DETAILS

4221009/B 07/2016

NOTES: (continued)

- 6. Publication IPC-7351 may have alternate designs.
- 7. Solder mask tolerances between and around signal pads can vary based on board fabrication site.

EXAMPLE STENCIL DESIGN

DW0016B

SOIC - 2.65 mm max height

SOIC

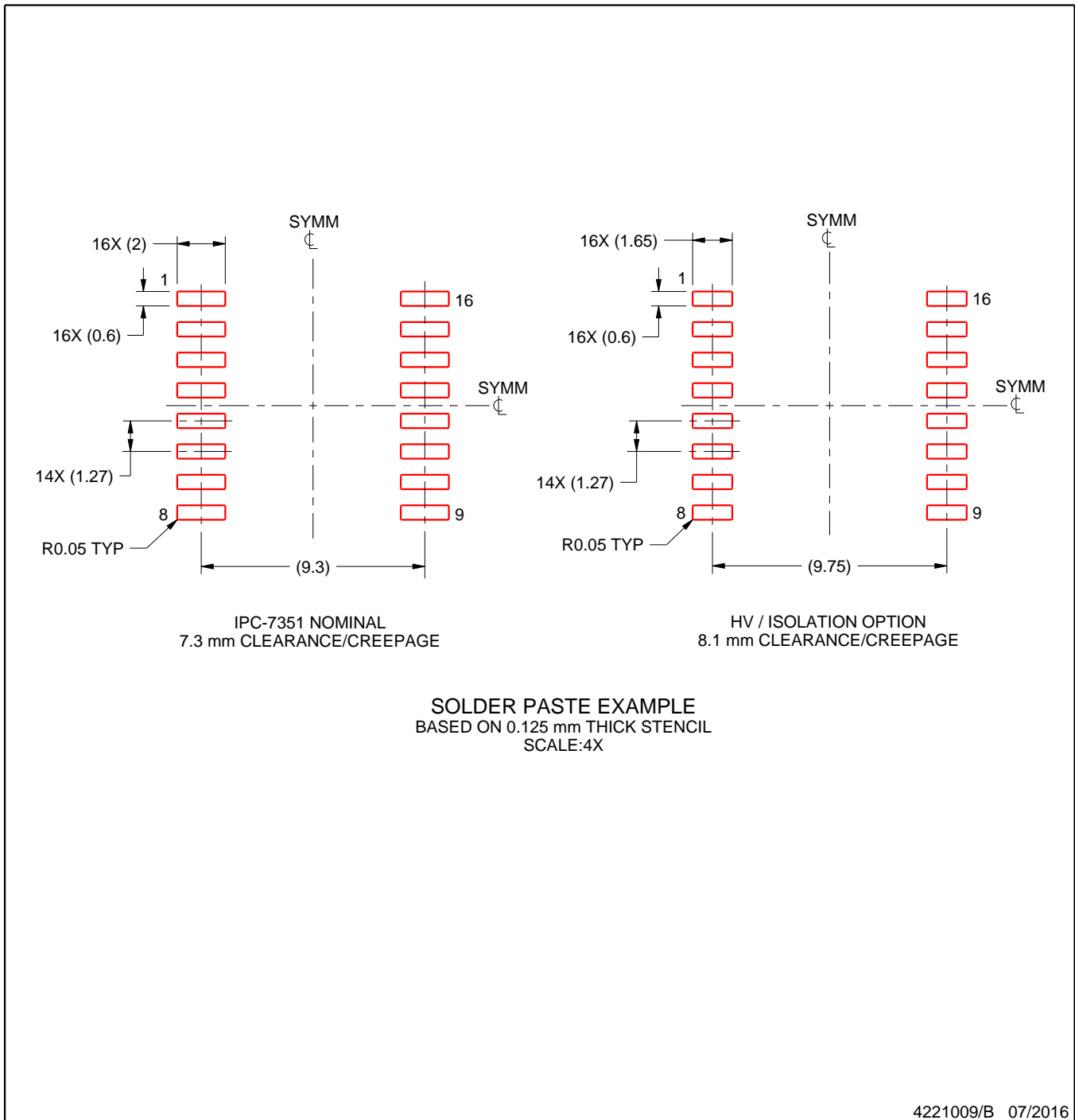

NOTES: (continued)

8. Laser cutting apertures with trapezoidal walls and rounded corners may offer better paste release. IPC-7525 may have alternate design recommendations.
9. Board assembly site may have different recommendations for stencil design.

IMPORTANT NOTICE AND DISCLAIMER

TI PROVIDES TECHNICAL AND RELIABILITY DATA (INCLUDING DATASHEETS), DESIGN RESOURCES (INCLUDING REFERENCE DESIGNS), APPLICATION OR OTHER DESIGN ADVICE, WEB TOOLS, SAFETY INFORMATION, AND OTHER RESOURCES "AS IS" AND WITH ALL FAULTS, AND DISCLAIMS ALL WARRANTIES, EXPRESS AND IMPLIED, INCLUDING WITHOUT LIMITATION ANY IMPLIED WARRANTIES OF MERCHANTABILITY, FITNESS FOR A PARTICULAR PURPOSE OR NON-INFRINGEMENT OF THIRD PARTY INTELLECTUAL PROPERTY RIGHTS.

These resources are intended for skilled developers designing with TI products. You are solely responsible for (1) selecting the appropriate TI products for your application, (2) designing, validating and testing your application, and (3) ensuring your application meets applicable standards, and any other safety, security, or other requirements. These resources are subject to change without notice. TI grants you permission to use these resources only for development of an application that uses the TI products described in the resource. Other reproduction and display of these resources is prohibited. No license is granted to any other TI intellectual property right or to any third party intellectual property right. TI disclaims responsibility for, and you will fully indemnify TI and its representatives against, any claims, damages, costs, losses, and liabilities arising out of your use of these resources.

TI's products are provided subject to TI's Terms of Sale (www.ti.com/legal/termsofsale.html) or other applicable terms available either on ti.com or provided in conjunction with such TI products. TI's provision of these resources does not expand or otherwise alter TI's applicable warranties or warranty disclaimers for TI products.

Mailing Address: Texas Instruments, Post Office Box 655303, Dallas, Texas 75265
Copyright © 2020, Texas Instruments Incorporated