

**SIPMOS<sup>®</sup> Small-Signal-Transistor**
**Features**

- P-Channel
- Enhancement mode
- Avalanche rated
- Logic Level
- dv/dt rated
- Pb-free lead plating; RoHS compliant
- Qualified according to AEC Q101
- Halogen-free according to IEC61249-2-21

**Product Summary**

Drain source voltage	$V_{DS}$	-60	V
Drain-source on-state resistance	$R_{DS(on)}$	8	$\Omega$
Continuous drain current	$I_D$	-0.15	A

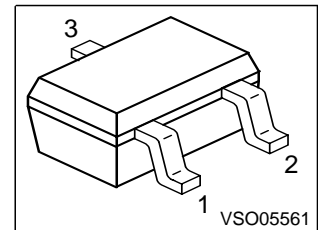

Type	Package	Tape and Reel	Marking	Pin 1	PIN 2	PIN 3
BSS84PW	PG-SOT-323	H6327:3000pcs/r.	YBs	G	S	D

**Maximum Ratings, at  $T_j = 25\text{ °C}$ , unless otherwise specified**

Parameter	Symbol	Value	Unit
Continuous drain current $T_A = 25\text{ °C}$	$I_D$	-0.15	A
Pulsed drain current $T_A = 25\text{ °C}$	$I_{D\text{ puls}}$	-0.6	
Avalanche energy, single pulse $I_D = -0.15\text{ A}$ , $V_{DD} = -25\text{ V}$ , $R_{GS} = 25\ \Omega$	$E_{AS}$	2.61	mJ
Avalanche energy, periodic limited by $T_{jmax}$	$E_{AR}$	0.03	
Reverse diode dv/dt $I_S = -0.15\text{ A}$ , $V_{DS} = -48\text{ V}$ , $di/dt = 200\text{ A}/\mu\text{s}$ , $T_{jmax} = 150\text{ °C}$	dv/dt	6	kV/ $\mu\text{s}$
Gate source voltage	$V_{GS}$	$\pm 20$	V
Power dissipation $T_A = 25\text{ °C}$	$P_{tot}$	0.3	W
Operating and storage temperature	$T_j, T_{stg}$	-55...+150	$^{\circ}\text{C}$
IEC climatic category; DIN IEC 68-1		55/150/56	
ESD Class JESF22-A114-HBM		Class 0	

**Thermal Characteristics**

Parameter	Symbol	Values			Unit
		min.	typ.	max.	
<b>Characteristics</b>					
Thermal resistance, junction - soldering point (Pin 3)	$R_{thJS}$	-	-	110	K/W
SMD version, device on PCB: @ min. footprint @ 6 cm <sup>2</sup> cooling area <sup>1)</sup>	$R_{thJA}$	-	-	420 350	

**Electrical Characteristics, at  $T_j = 25\text{ °C}$ , unless otherwise specified**

Parameter	Symbol	Values			Unit
		min.	typ.	max.	
<b>Static Characteristics</b>					
Drain-source breakdown voltage $V_{GS} = 0\text{ V}$ , $I_D = -250\text{ }\mu\text{A}$	$V_{(BR)DSS}$	-60	-	-	V
Gate threshold voltage, $V_{GS} = V_{DS}$ $I_D = -20\text{ }\mu\text{A}$	$V_{GS(th)}$	-1	-1.5	-2	
Zero gate voltage drain current $V_{DS} = -60\text{ V}$ , $V_{GS} = 0\text{ V}$ , $T_j = 25\text{ °C}$ $V_{DS} = -60\text{ V}$ , $V_{GS} = 0\text{ V}$ , $T_j = 125\text{ °C}$	$I_{DSS}$	-	-0.1 -10	-1 -100	$\mu\text{A}$
Gate-source leakage current $V_{GS} = -20\text{ V}$ , $V_{DS} = 0\text{ V}$	$I_{GSS}$	-	-10	-100	nA
Drain-source on-state resistance $V_{GS} = -2.7\text{ V}$ , $I_D = -0.01\text{ A}$	$R_{DS(on)}$	-	10.5	25	$\Omega$
Drain-source on-state resistance $V_{GS} = -4.5\text{ V}$ , $I_D = -0.12\text{ A}$	$R_{DS(on)}$	-	6.9	12	
Drain-source on-state resistance $V_{GS} = -10\text{ V}$ , $I_D = -0.15\text{ A}$	$R_{DS(on)}$	-	4.6	8	

<sup>1)</sup>Device on 40mm\*40mm\*1.5mm epoxy PCB FR4 with 6cm<sup>2</sup> (one layer, 70  $\mu\text{m}$  thick) copper area for drain connection. PCB is vertical without blown air.

**Electrical Characteristics**, at  $T_j = 25\text{ }^\circ\text{C}$ , unless otherwise specified

Parameter	Symbol	Conditions	Values			Unit
			min.	typ.	max.	

**Dynamic Characteristics**

Transconductance	$g_{fs}$	$V_{DS} \leq 2 \cdot I_D \cdot R_{DS(on)max}$ , $I_D = 0.15\text{A}$	0.08	0.16	-	S
Input capacitance	$C_{iss}$	$V_{GS} = 0\text{V}$ , $V_{DS} = -25\text{V}$ , $f = 1\text{MHz}$	-	15.3	19.1	pF
Output capacitance	$C_{oss}$		-	5.8	7.3	
Reverse transfer capacitance	$C_{rss}$		-	3	3.8	
Turn-on delay time	$t_{d(on)}$	$V_{DD} = -30\text{V}$ , $V_{GS} = -4.5\text{V}$ , $I_D = -0.12\text{A}$ , $R_G = 25\Omega$	-	6.7	10	ns
Rise time	$t_r$		-	16.2	24.3	
Turn-off delay time	$t_{d(off)}$		-	8.6	12.9	
Fall time	$t_f$		-	20.5	30.8	

**Gate Charge Characteristics**

Gate to source charge	$Q_{gs}$	$V_{DD} = -48\text{V}$ , $I_D = -0.15\text{A}$	-	0.25	0.38	nC
Gate to drain charge	$Q_{gd}$		-	0.3	0.45	
Gate charge total	$Q_g$	$V_{DD} = -48\text{V}$ , $I_D = -0.15\text{A}$ , $V_{GS} = 0$ to $-10\text{V}$	-	1	1.5	
Gate plateau voltage	$V_{(plateau)}$	$V_{DD} = -48\text{V}$ , $I_D = -0.15\text{A}$	-	-3.4	-	V

**Reverse Diode**

Inverse diode continuous forward current	$I_S$	$T_A = 25\text{ }^\circ\text{C}$	-	-	-0.15	A
Inverse diode direct current, pulsed	$I_{SM}$		-	-	-0.6	
Inverse diode forward voltage	$V_{SD}$	$V_{GS} = 0\text{V}$ , $I_F = -0.15\text{A}$	-	-0.84	-1.12	V
Reverse recovery time	$t_{rr}$	$V_R = -30\text{V}$ , $I_F = I_S$ , $di_F/dt = 100\text{A}/\mu\text{s}$	-	23.6	35.4	ns
Reverse recovery charge	$Q_{rr}$		-	11.6	17.4	

**Power Dissipation**

$$P_{tot} = f(T_A)$$

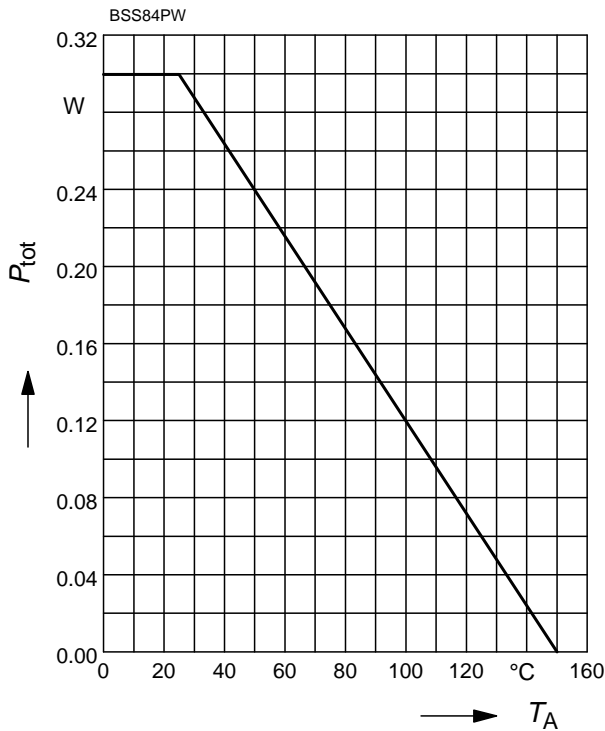

**Drain current**

$$I_D = f(T_A)$$

parameter:  $V_{GS} \geq 10 \text{ V}$

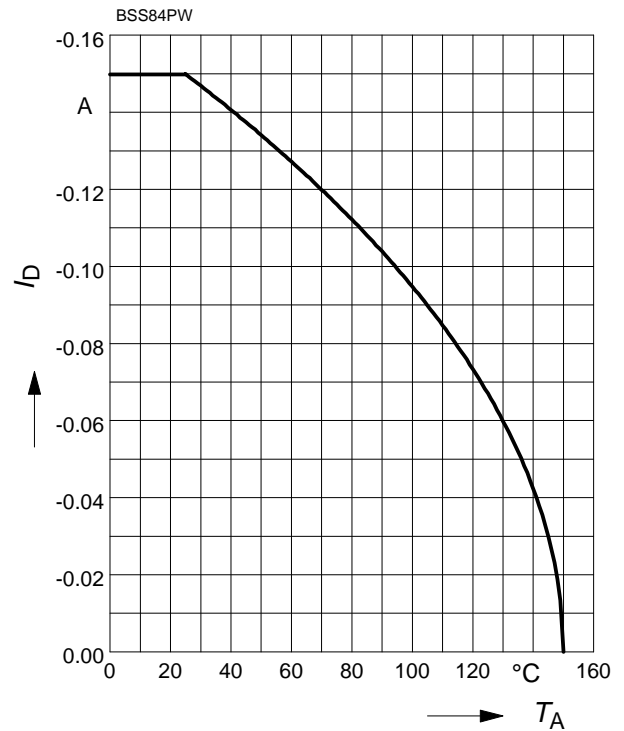

**Safe operating area**

$$I_D = f(V_{DS})$$

parameter:  $D = 0, T_A = 25 \text{ °C}$

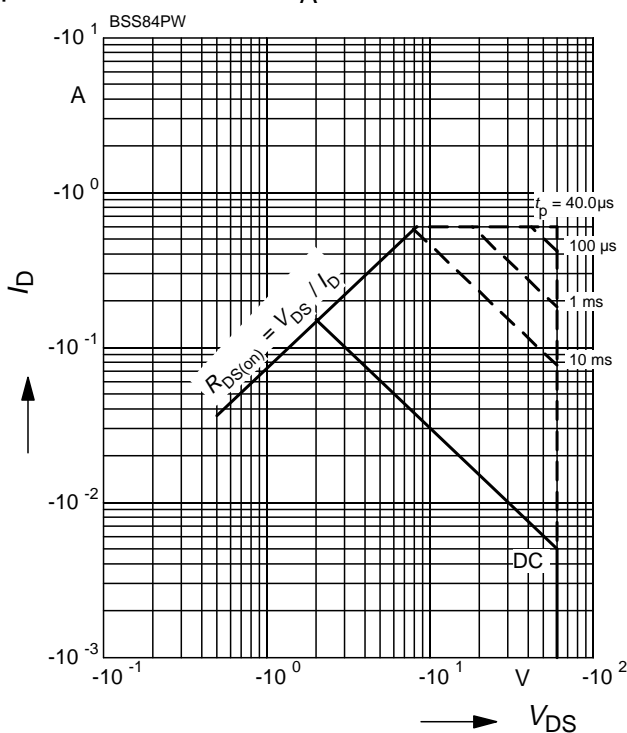

**Transient thermal impedance**

$$Z_{thJA} = f(t_p)$$

parameter:  $D = t_p/T$

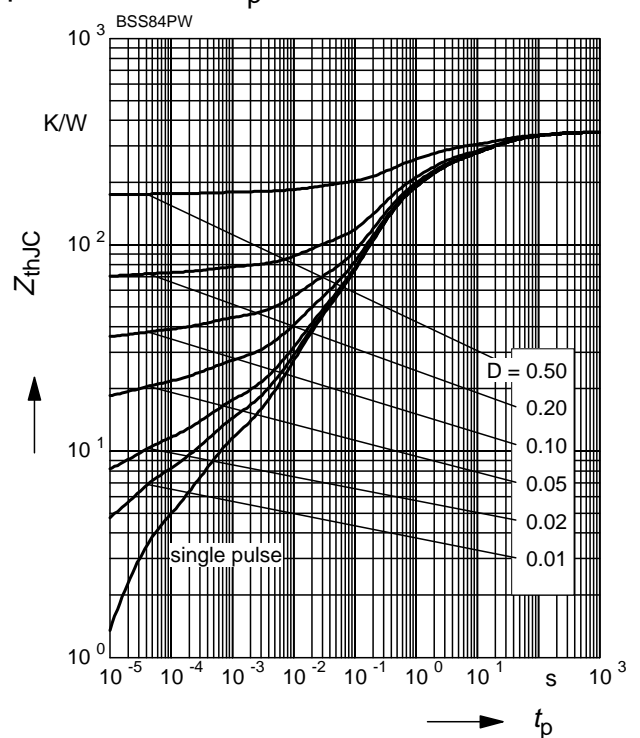

**Typ. output characteristic**

$I_D = f(V_{DS}); T_j = 25^\circ\text{C}$

parameter:  $t_p = 80 \mu\text{s}$

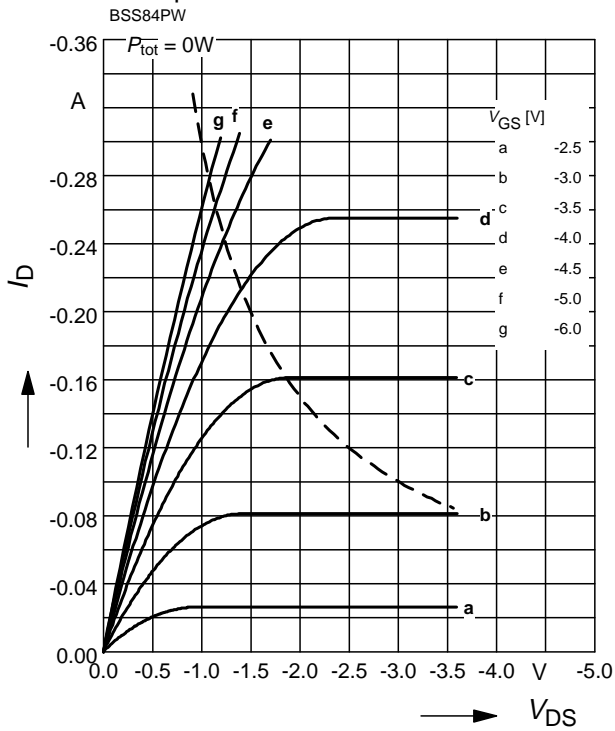

**Typ. drain-source-on-resistance**

$R_{DS(on)} = f(I_D)$

parameter:  $V_{GS}$

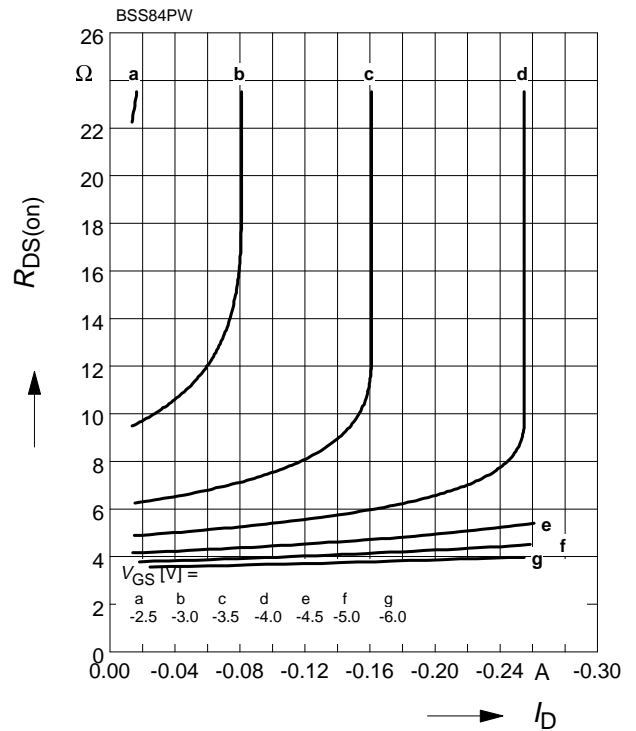

**Typ. transfer characteristics  $I_D = f(V_{GS})$**

$V_{DS} \geq 2 \times I_D \times R_{DS(on)max}$

parameter:  $t_p = 80 \mu\text{s}$

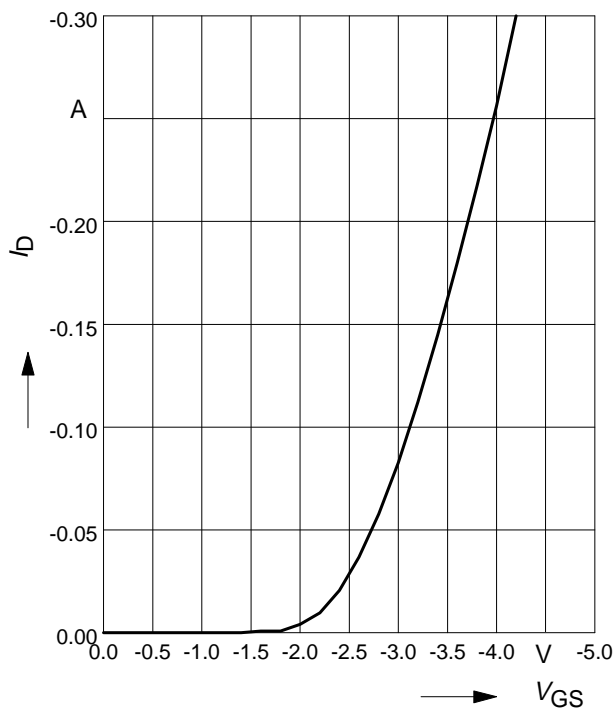

**Typ. forward transconductance**

$g_{fs} = f(I_D); T_j = 25^\circ\text{C}$

parameter:  $g_{fs}$

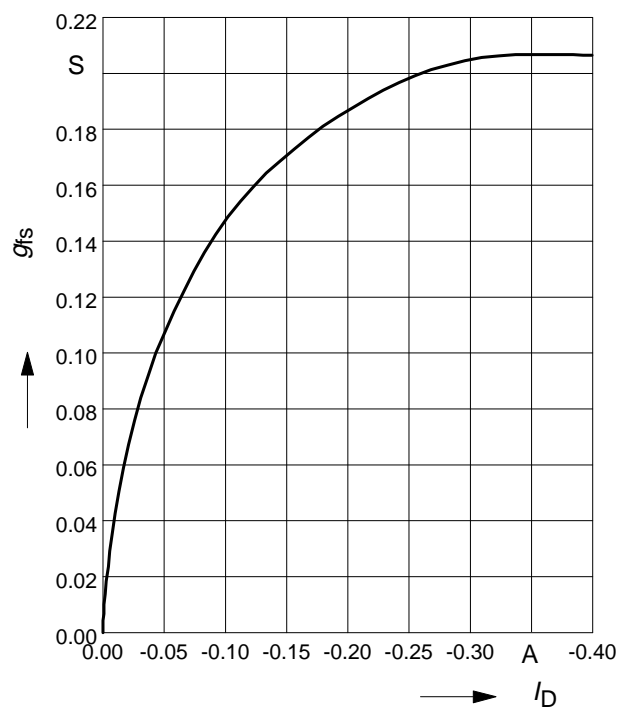

**Drain-source on-resistance**

$$R_{DS(on)} = f(T_j)$$

parameter:  $I_D = -0.17A$ ,  $V_{GS} = -10V$

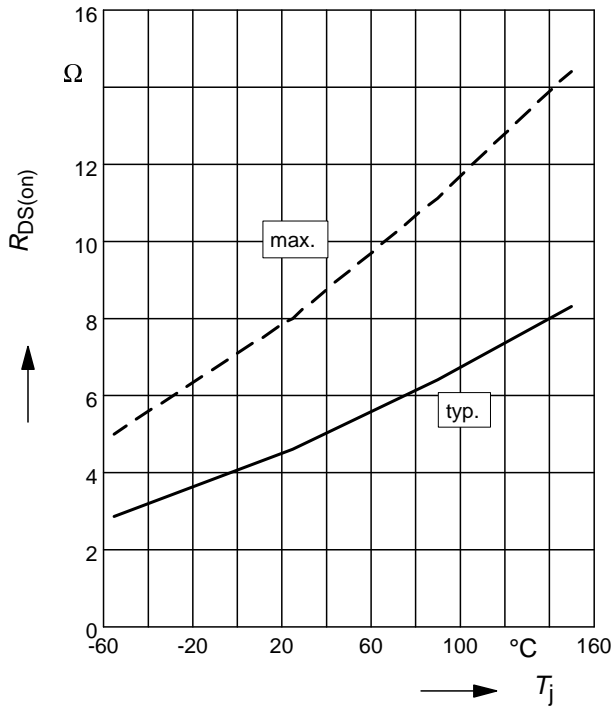

**Gate threshold voltage**

$$V_{GS(th)} = f(T_j)$$

parameter:  $V_{GS} = V_{DS}$ ,  $I_D = -20 \mu A$

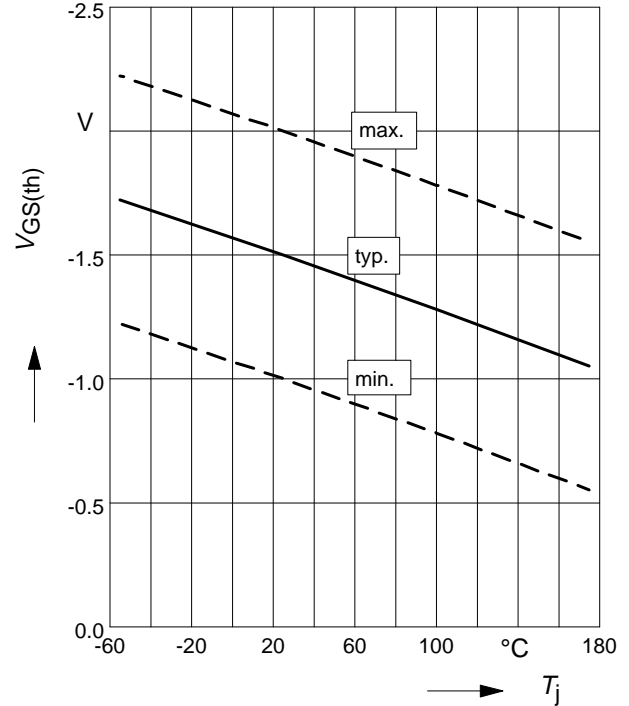

**Typ. capacitances**

$$C = f(V_{DS})$$

Parameter:  $V_{GS} = 0V$ ,  $f = 1MHz$

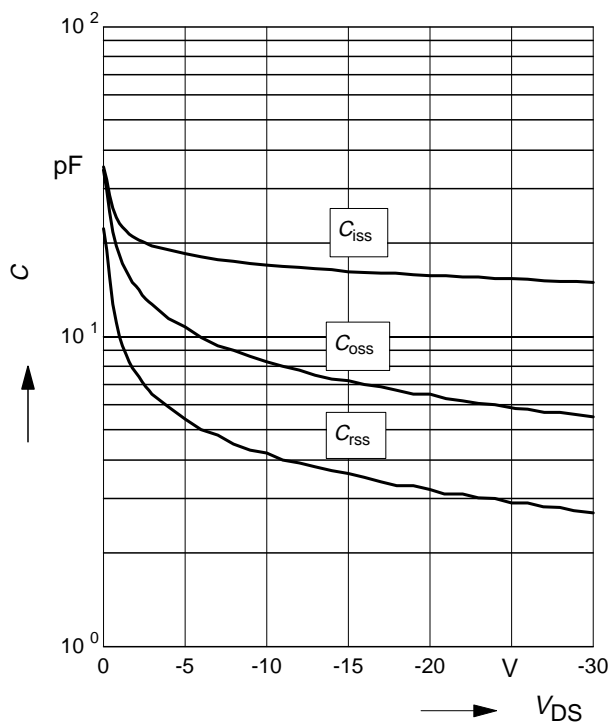

**Forward characteristics of reverse diode**

$$I_F = f(V_{SD})$$

parameter:  $T_j$ ,  $t_p = 80 \mu s$

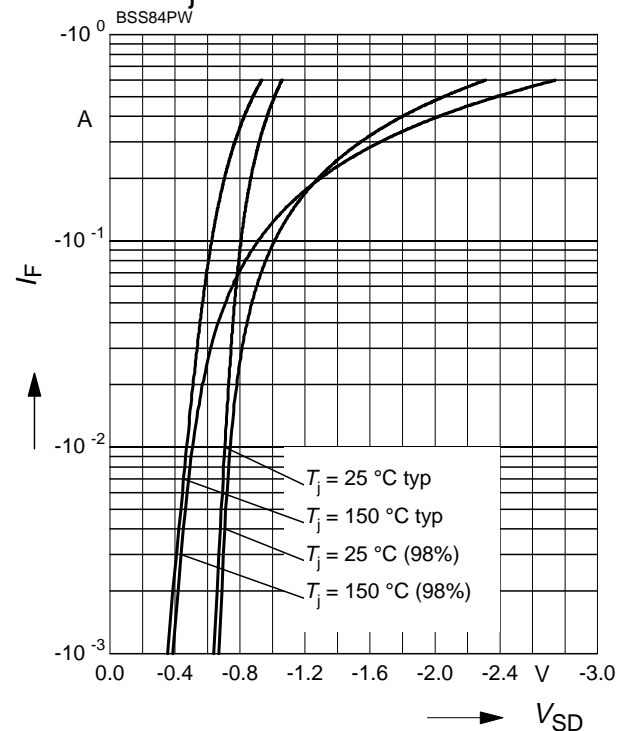

**Avalanche energy**

$$E_{AS} = f(T_j)$$

par.:  $I_D = -0.15 \text{ A}$  ,  $V_{DD} = -25 \text{ V}$  ,  $R_{GS} = 25 \ \Omega$

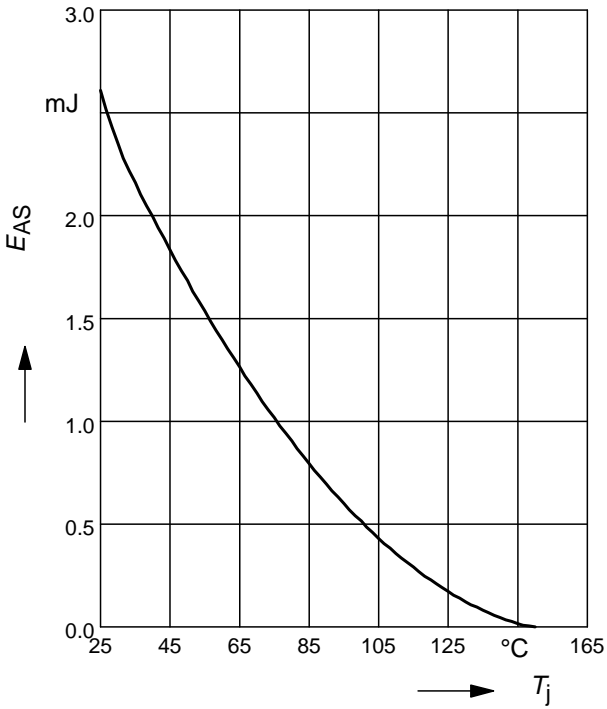

**Typ. gate charge**

$$V_{GS} = f(Q_{Gate})$$

parameter:  $I_D = -0.15 \text{ A}$  pulsed

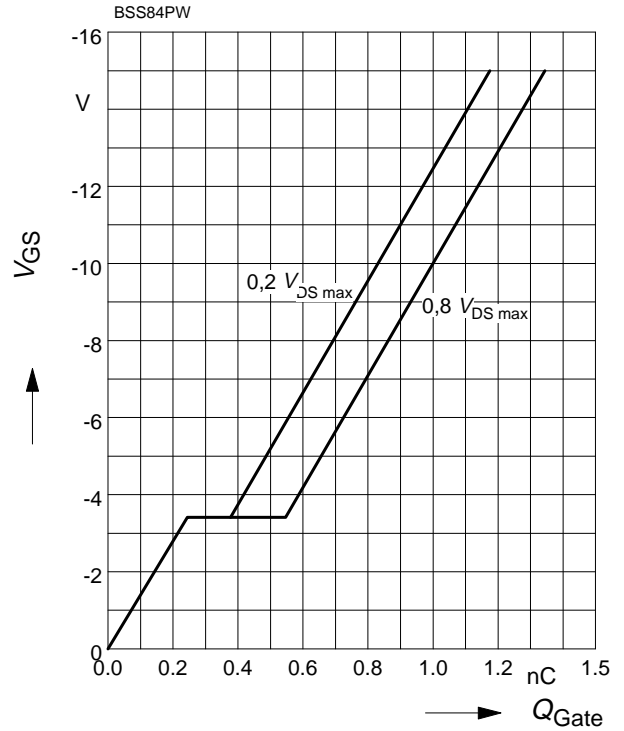

**Drain-source breakdown voltage**

$$V_{(BR)DSS} = f(T_j)$$

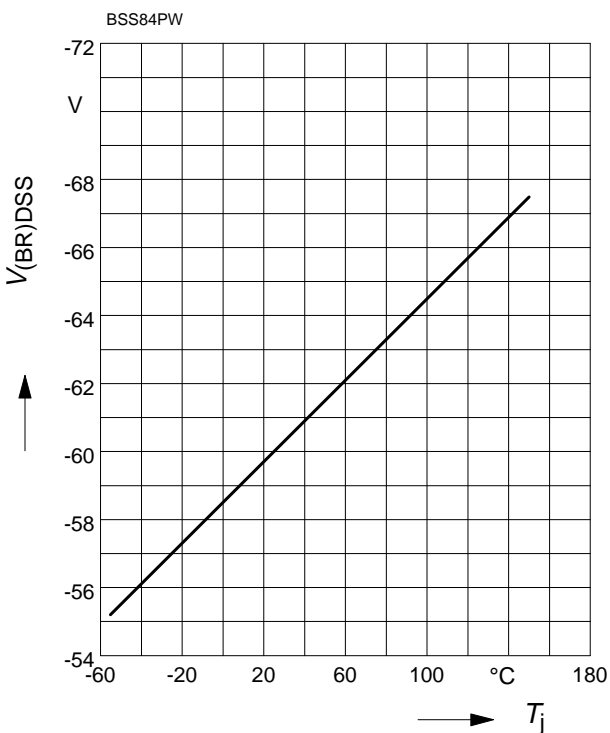

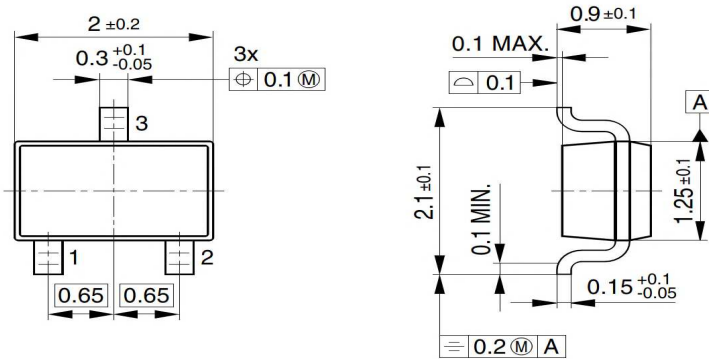
**Package Outline SOT-323**

**Footprint**

Soldering type: Reflow soldering

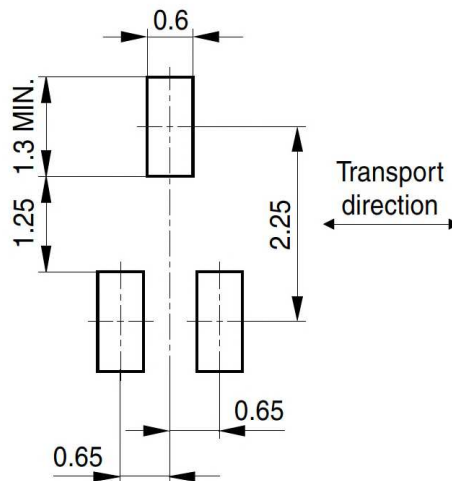
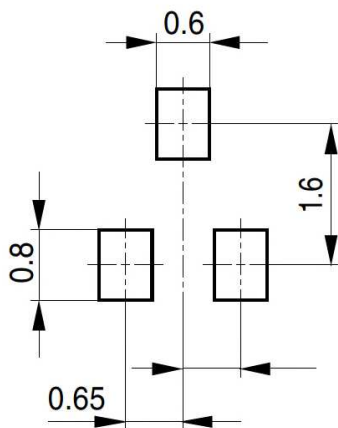
Soldering type: Wave soldering

**Tape and Reel**

Reel  $\varnothing 180$  mm: 3.000 Pieces/Reel  
 Reels/Box: 1 x 3.000 = 3.000  
 Reels/Box: 10 x 3.000 = 30.000

Reel  $\varnothing 330$  mm: 10.000 Pieces/Reel  
 Reels/Box: 1 x 10.000 = 10.000

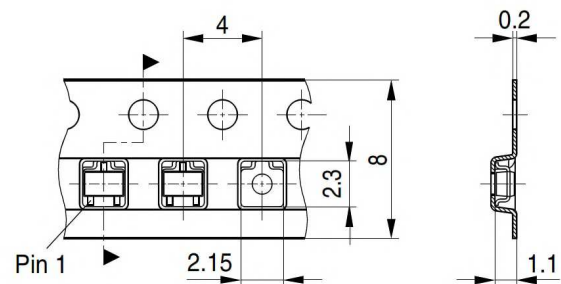



# -60V SIPMOS Small Signal Transistor

## BSS84PW

### Revision History

BSS84PW

**Revision: 2016-06-27, Rev. 2.0**

Previous Revision

Revision	Date	Subjects (major changes since last revision)
2.0	2016-06-27	Release of final version

#### Trademarks of Infineon Technologies AG

AURIX™, C166™, CanPAK™, CIPOS™, CoolGaN™, CoolMOS™, CoolSET™, CoolSiC™, CORECONTROL™, CROSSAVE™, DAVE™, DI-POL™, DrBlade™, EasyPIM™, EconoBRIDGE™, EconoDUAL™, EconoPACK™, EconoPIM™, EiceDRIVER™, eupec™, FCOS™, HITFET™, HybridPACK™, Infineon™, ISOFACE™, IsoPACK™, i-Wafer™, MIPAQ™, ModSTACK™, my-d™, NovalithIC™, OmniTune™, OPTIGA™, OptiMOS™, ORIGA™, POWERCODE™, PRIMARION™, PrimePACK™, PrimeSTACK™, PROFET™, PRO-SIL™, RASIC™, REAL3™, ReverSave™, SatRIC™, SIEGET™, SIPMOS™, SmartLEWIS™, SOLID FLASH™, SPOC™, TEMPFET™, thinQ!™, TRENCHSTOP™, TriCore™.

Trademarks updated August 2015

#### Other Trademarks

All referenced product or service names and trademarks are the property of their respective owners.

#### We Listen to Your Comments

Any information within this document that you feel is wrong, unclear or missing at all? Your feedback will help us to continuously improve the quality of this document. Please send your proposal (including a reference to this document) to:

[erratum@infineon.com](mailto:erratum@infineon.com)

**Published by**  
**Infineon Technologies AG**  
**81726 München, Germany**  
**© 2016 Infineon Technologies AG**  
**All Rights Reserved.**

#### Legal Disclaimer

The information given in this document shall in no event be regarded as a guarantee of conditions or characteristics. With respect to any examples or hints given herein, any typical values stated herein and/or any information regarding the application of the device, Infineon Technologies hereby disclaims any and all warranties and liabilities of any kind, including without limitation, warranties of non-infringement of intellectual property rights of any third party.

#### Information

For further information on technology, delivery terms and conditions and prices please contact your nearest Infineon Technologies Office ([www.infineon.com](http://www.infineon.com)).

#### Warnings

Due to technical requirements, components may contain dangerous substances. For information on the types in question, please contact the nearest Infineon Technologies Office.

The Infineon Technologies component described in this Data Sheet may be used in life-support devices or systems and/or automotive, aviation and aerospace applications or systems only with the express written approval of Infineon Technologies, if a failure of such components can reasonably be expected to cause the failure of that life-support, automotive, aviation and aerospace device or system or to affect the safety or effectiveness of that device or system. Life support devices or systems are intended to be implanted in the human body or to support and/or maintain and sustain and/or protect human life. If they fail, it is reasonable to assume that the health of the user or other persons may be endangered.

# Mouser Electronics

Authorized Distributor

Click to View Pricing, Inventory, Delivery & Lifecycle Information:

[Infineon:](#)

[BSS84PWH6327XTSA1](#) [BSS84PW H6327](#) [BSS84PWH6327XT](#)