

Features

- Glass Passivated Die Construction
- Super-Fast Recovery Time For High Efficiency
- Low Forward Voltage Drop and High Current Capability
- Surge Overload Rating to 35A Peak
- Ideally Suited for Automated Assembly
- **Lead Free Finish, RoHS Compliant (Note 5)**

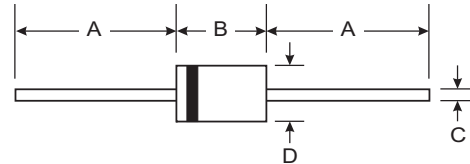

Mechanical Data

- Case: DO-41
- Case Material: Molded Plastic. UL Flammability Classification Rating 94V-0
- Moisture Sensitivity: Level 1 per J-STD-020C
- Terminals: Finish — Bright Tin. Solderable per MIL-STD-202, Method 208
- Marking: MUR140: R140
MUR160: R160
- Polarity: Cathode Band
- Mounting Position: Any
- Weight: 0.35 grams (approximate)

DO-41 Plastic		
Dim	Min	Max
A	25.40	—
B	4.06	5.21
C	0.71	0.864
D	2.00	2.72
All Dimensions in mm		

Maximum Ratings and Electrical Characteristics

@ $T_A = 25^\circ\text{C}$ unless otherwise specified

Single phase, half wave, 60Hz, resistive or inductive load.
For capacitive load, derate current by 20%.

Characteristic	Symbol	MUR140	MUR160	Unit
Peak Repetitive Reverse Voltage Working Peak Reverse Voltage DC Blocking Voltage	V_{RRM} V_{RWM} V_R	400	600	V
RMS Reverse Voltage	$V_{R(RMS)}$	283	424	V
Average Rectified Output Current @ $T_J = 120^\circ\text{C}$	I_O	1.0		A
Non-Repetitive Peak Forward Surge Current 8.3ms Single half sine-wave Superimposed on Rated Load (JEDEC Method)	I_{FSM}	35		A
Forward Voltage @ $I_F = 1.0\text{A}, T_J = 25^\circ\text{C}$ @ $I_F = 1.0\text{A}, T_J = 150^\circ\text{C}$	V_{FM}	1.25 1.05		V
Peak Reverse Current at Rated DC Blocking Voltage @ $T_A = 25^\circ\text{C}$ @ $T_A = 150^\circ\text{C}$	I_{RM}	5.0 150		μA
Reverse Recovery Time (Note 2)	t_{rr}	50		ns
Reverse Recovery Time (Note 3)	t_{rr}	75		ns
Forward Recovery Time (Note 4)	t_{fr}	50		ns
Typical Junction Capacitance (Note 1)	C_j	45		pF
Typical Thermal Resistance, Junction to Ambient	$R_{\theta JA}$	72		K/W
Operating and Storage Temperature Range	T_J, T_{STG}	-65 to +175		$^\circ\text{C}$

- Notes:
1. Measured at 1.0MHz and applied reverse voltage of 0V DC.
 2. Measured with $I_F = 0.5\text{A}, I_R = 1.0\text{A}, I_{rr} = 0.25\text{A}$. See Figure 5.
 3. Measured with $I_F = 1\text{A}, di/dt = 50\text{A}/\mu\text{s}$.
 4. Measured with $I_F = 1.0\text{A}, di/dt = 100\text{A}/\mu\text{s}$, Duty Cycle $\leq 2.0\%$.
 5. RoHS revision 13.2.2003. Glass and High Temperature Solder Exemptions Applied, see *EU Directive Annex Notes 5 and 7*.

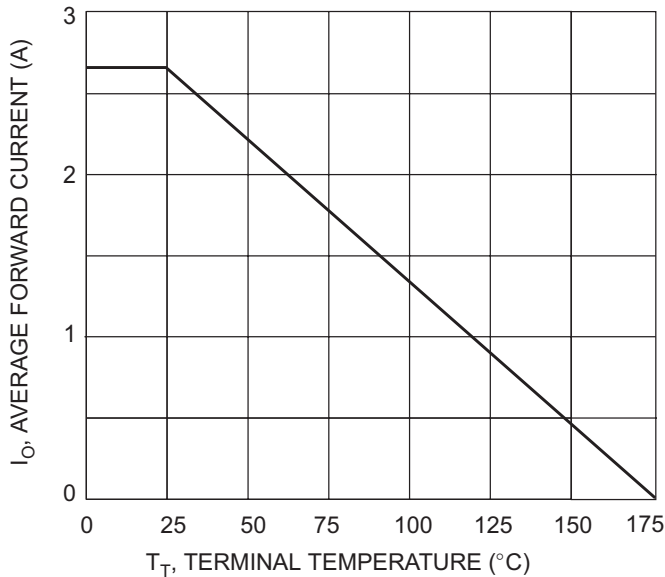

Fig. 1 Forward Current Derating Curve

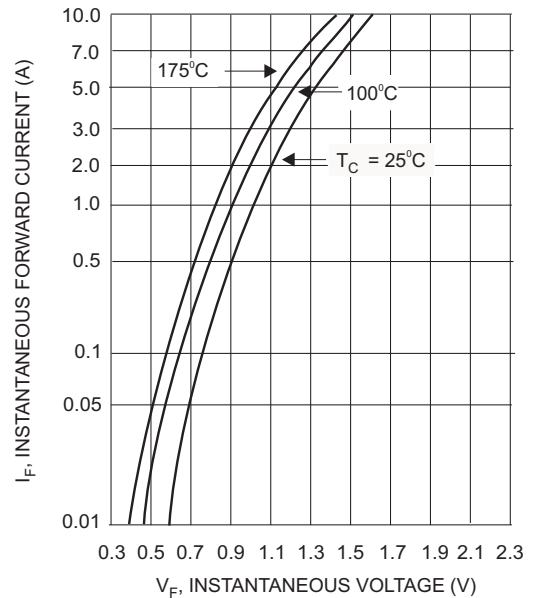

Fig. 2 Typical Forward Current

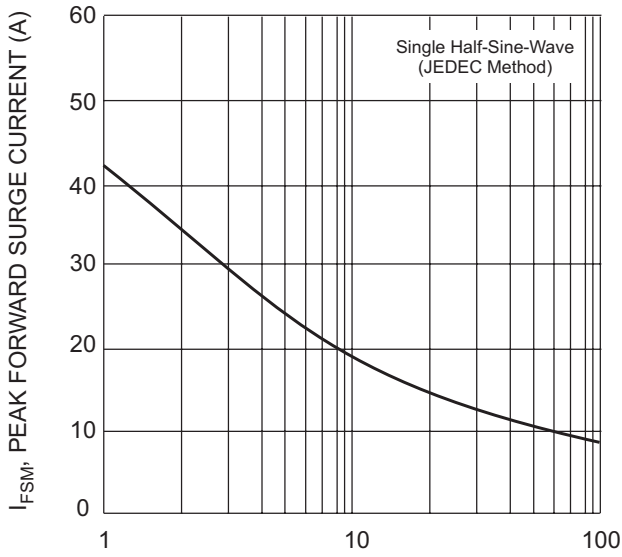

Fig. 3 Surge Current Derating Curve

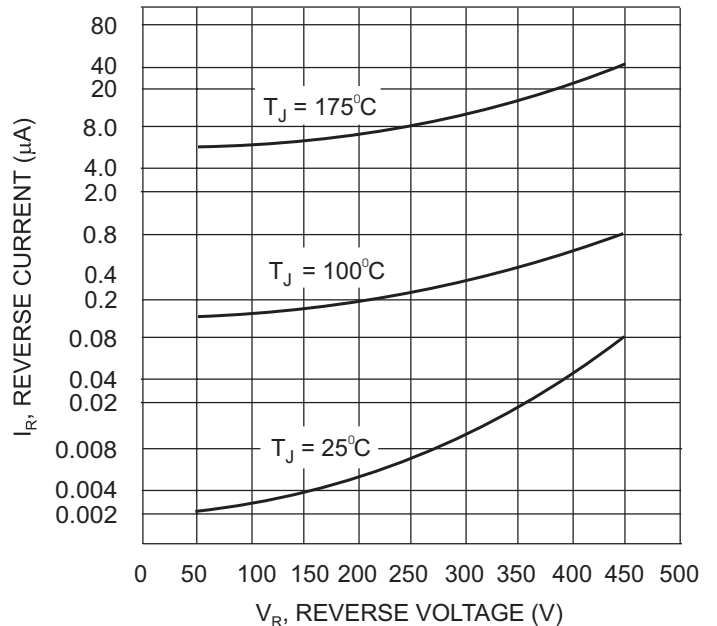
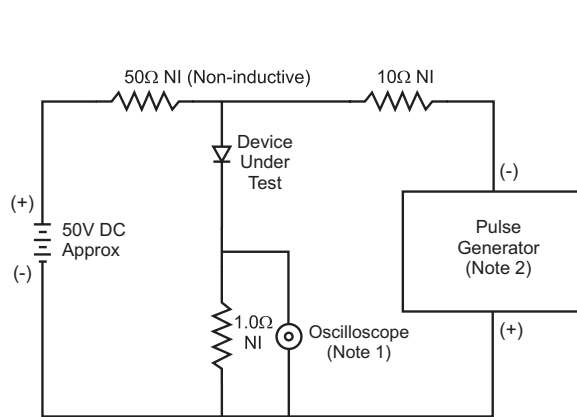
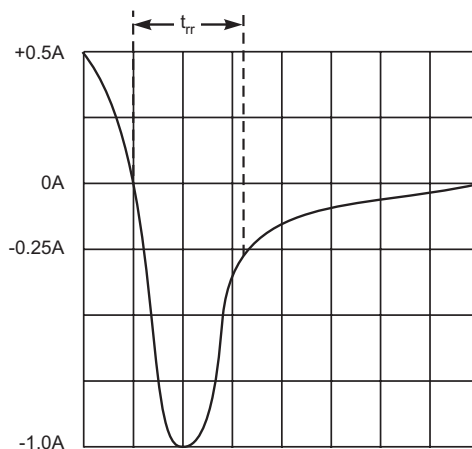

Fig. 4 Typical Reverse Current



- Notes:
1. Rise Time = 7.0ns max. Input Impedance = 1.0MΩ, 22pF.
 2. Rise Time = 10ns max. Input Impedance = 50Ω.



Set time base for 50/100 ns/cm

Fig. 5 Reverse Recovery Time Characteristic and Test Circuit

Ordering Information (Note 6)

Device	Packaging	Shipping
MUR140-A	DO-41	5K/Ammo Pack
MUR140-B	DO-41	1K/Bulk
MUR140-T	DO-41	5K/Tape & Reel, 13-inch
MUR160-A	DO-41	5K/Ammo Pack
MUR160-B	DO-41	1K/Bulk
MUR160-T	DO-41	5K/Tape & Reel, 13-inch

Notes: 6. For packaging details, visit our website at <http://www.diodes.com/datasheets/ap02008.pdf>

Mouser Electronics

Authorized Distributor

Click to View Pricing, Inventory, Delivery & Lifecycle Information:

[Diodes Incorporated:](#)

[MUR140-T](#) [MUR160-T](#) [MURB1610CT-T](#) [MURB1610CT-T-F](#)