

### GaAs SP3T SWITCH MMIC for 2.4GHz Wireless Communication

#### ■ Applications

Typical applications are 2.4GHz WLAN systems and Bluetooth systems.

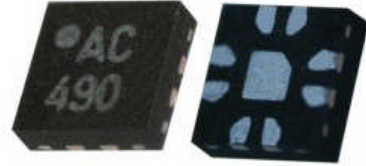

#### ■ Features

- Positive Low Control Voltage..... +2.6V
- Low Insertion Loss ..... IL=0.5dB typ.
- High Isolation ..... ISO=36dB typ.@WLAN Rx - BT
- Small / Thin Package ..... 8 pin Leadless Package (2mm x 2mm x 0.55mm, RoHS Compliant)
- MSL ..... 3

#### ■ Absolute Maximum Ratings

Symbol	Parameter	Conditions	Rating	Unit
VCTL(H)	Control Voltage (High)	Ta = 25°C	5.5	V
VCTL(L)	Control Voltage (Low)	Ta = 25°C	0	V
Pin	RF Input Power (WLAN Tx)	Ta = 25°C 2.6 ≤ VCTL(H)-VCTL(L) ≤ 5.5V	30	dBm
	RF Input Power (BT, WLAN Rx)		20	dBm
Top	Operating Temperature	-	-40 to +85	°C
Tstg	Storage Temperature	-	-55 to +150	°C

#### ■ Electrical Specifications

(Ta=25°C, VCTL(H)=2.6V, VCTL(L)=0V)

Symbol	Parameter	Conditions	Min.	Typ.	Max.	Unit
VCTL	Control Voltage	-	2.6	-	-	V
ICTL	Control Current	Either State	-	0.1	60	μA
f <sub>o</sub>	Operation Frequency	-	2.4	-	2.5	GHz
IL	Insertion Loss	ANT - WLAN Rx	-	0.5	0.8	dB
		ANT - WLAN Tx	-	0.5	0.8	dB
		ANT - BT	-	0.5	0.8	dB
ISO	Isolation	ANT - WLAN Rx	22	25	-	dB
		ANT - WLAN Tx	19	23	-	dB
		WLAN Rx – BT(Rx mode)	32	36	-	dB
		WLAN Rx – BT(BT mode)	22	25	-	dB
P <sub>in0.5dB</sub>	Input Power for 0.5dB Compression	WLAN Tx - ANT	29	31	-	dBm

### ■ Package Outline and Pin Connections

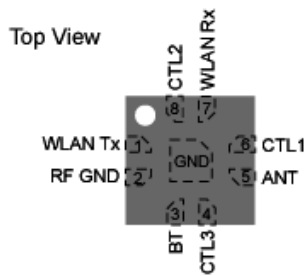
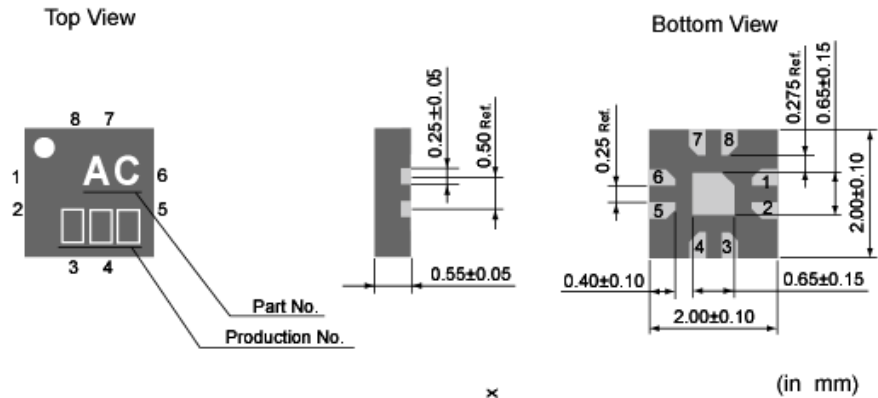

### ■ Block Diagram

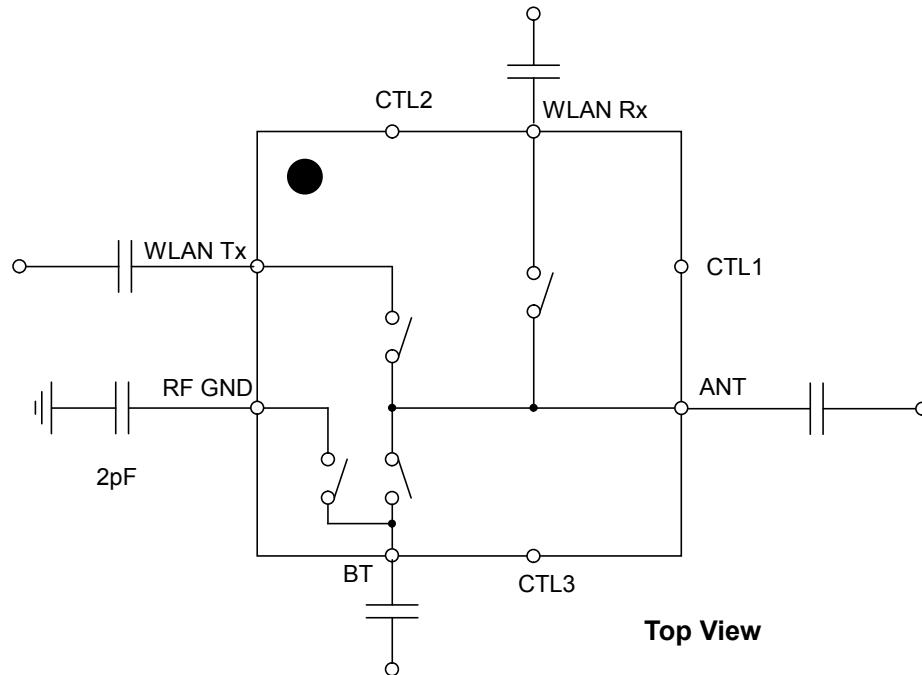

■ Land Pattern

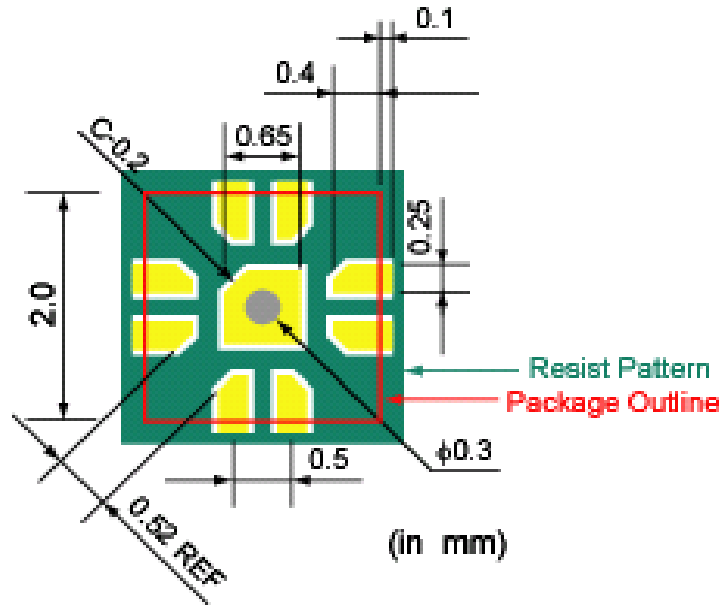

■ Evaluation Board

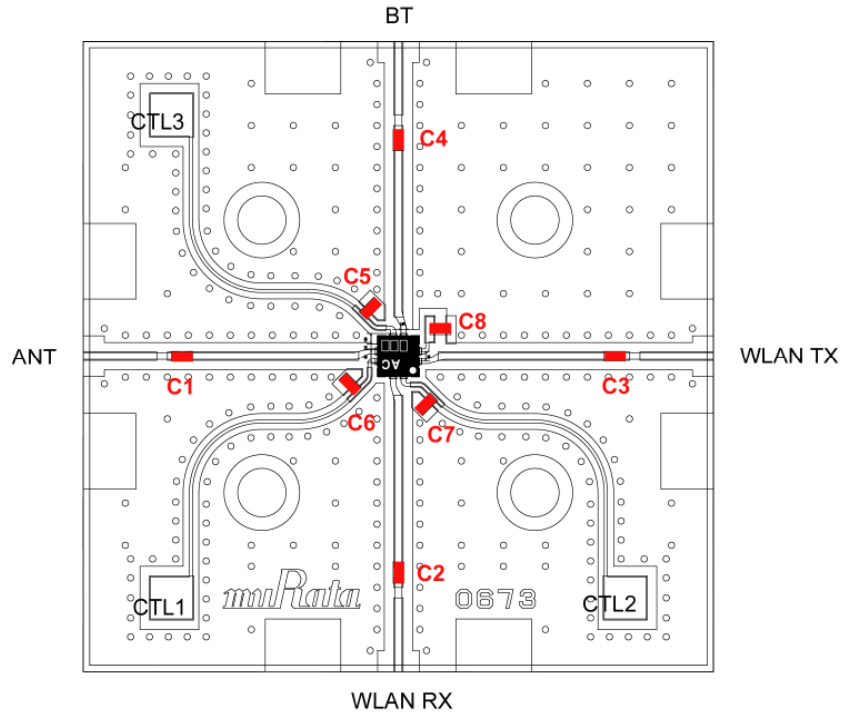

**Parts List**

Part No.	Products	Value
C1 - C4	GRM155 (Murata)	47pF
C5 - C7		100pF
C8		2pF

**Substrate**

Material : FR4 ( $\epsilon_r=4.4$ )
Size : 30mm × 30mm
Thickness : 0.2mm

■ Truth Table

Path	CTL1	CTL2	CTL3
ANT - WLAN Rx	H*	L*	L*
ANT - WLAN Tx	L*	H*	L*
ANT - BT	L*	L*	H*

\* : H.....2.6V  
L .....0V

■ Typical Performance Data (On Evaluation Board, Fixture's Loss de-embedded)

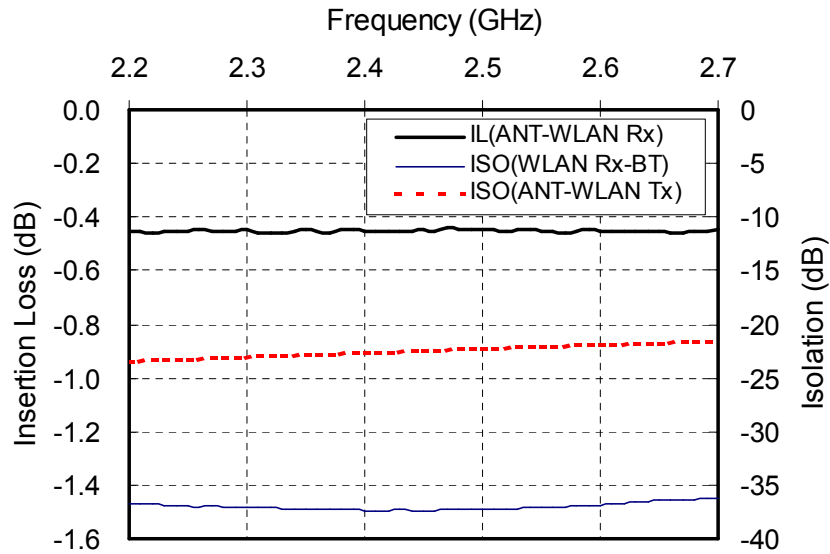

Fig.1 ANT-WLAN Rx ON-mode

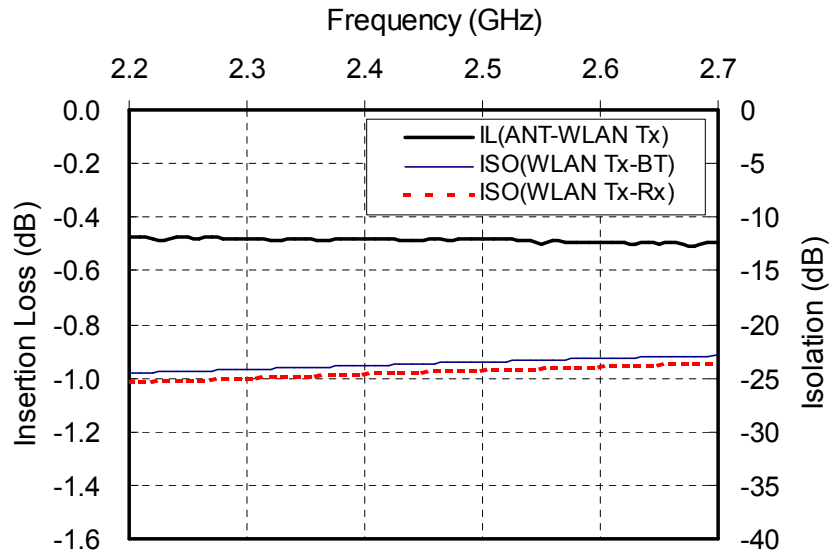

Fig.2 ANT-WLAN Tx ON-mode

■ Typical Performance Data (On Evaluation Board, Fixture's Loss de-embedded)

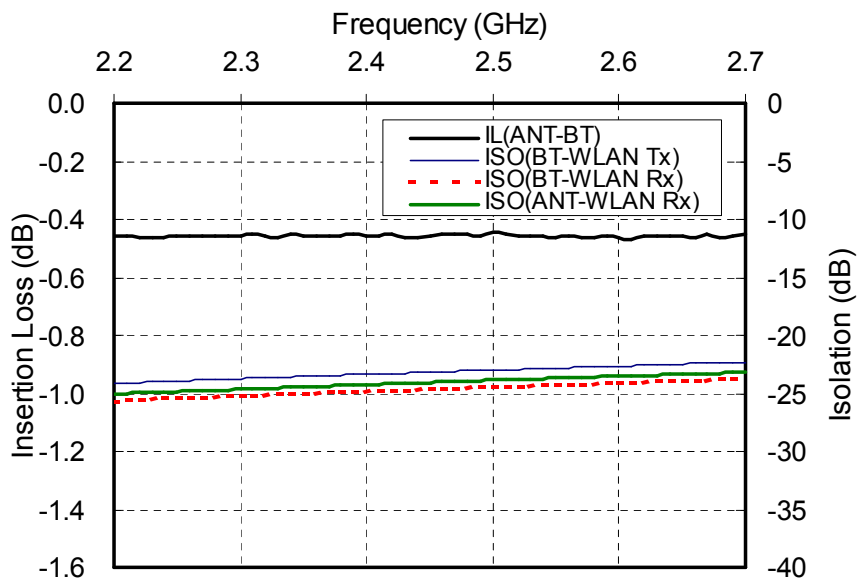

Fig.3 ANT-BT ON-mode



CAUTION -Limitation of Applications-

The product is designed and manufactured for consumer application only and is not available for any application listed below which requires especially high reliability for the prevention of such defect as may directly cause damage to the third party's life, body or property.

- Aircraft equipment.
- Aerospace equipment.
- Undersea equipment.
- Medical equipment.
- Transportation equipment (vehicles, trains, ships, etc.).
- Traffic signal equipment.
- Disaster prevention / crime prevention equipment.
- Application of similar complexity and/ or reliability requirements to the applications listed in the above.

# Mouser Electronics

Authorized Distributor

Click to View Pricing, Inventory, Delivery & Lifecycle Information:

[Murata:](#)

[XM2400SN-AL0901](#) [XM2400SN-AL0907](#) [XM2400SN-AL0908](#)