

BACKUP-BATTERY SUPERVISORS FOR RAM RETENTION

FEATURES

- Supply Current of 40 μ A (Max)
- Battery-Supply Current of 100 nA (Max)
- Precision Supply Voltage Monitor 3.3 V, 5 V, Other Options on Request
- Backup-Battery Voltage Can Exceed V_{DD}
- Power On Reset Generator With Fixed 100-ms Reset Delay Time
- Voltage Monitor For Power-Fail or Low-Battery Monitoring
- Battery Freshness Seal (TPS3619)
- Pin-For-Pin Compatible With MAX819, MAX703, and MAX704
- 8-Pin MSOP Package
- Temperature Range -40°C to $+85^{\circ}\text{C}$

APPLICATIONS

- Fax Machines
- Set-Top Boxes
- Advanced Voice Mail Systems
- Portable Battery-Powered Equipment
- Computer Equipment
- Advanced Modems
- Automotive Systems
- Portable Long-Time Monitoring Equipment
- Point-of-Sale Equipment

DESCRIPTION

The TPS3619 and TPS3620 families of supervisory circuits monitor and control processor activity by providing backup-battery switchover for data retention of CMOS RAM.

During power on, $\overline{\text{RESET}}$ is asserted when the supply voltage (V_{DD} or V_{BAT}) becomes higher than 1.1 V. Thereafter, the supply voltage supervisor monitors V_{DD} and keeps $\overline{\text{RESET}}$ output active as long as V_{DD} remains below the threshold voltage (V_{IT}). An internal timer delays the return of the output to the inactive state (high) to ensure proper system reset. The delay time starts after V_{DD} has risen above V_{IT} . When the supply voltage drops below V_{IT} , the output becomes active (low) again.

The product spectrum is designed for supply voltages of 3.3 V and 5 V. The TPS3619 and TPS3620 are available in an 8-pin MSOP package and are characterized for operation over a temperature range of -40°C to $+85^{\circ}\text{C}$.

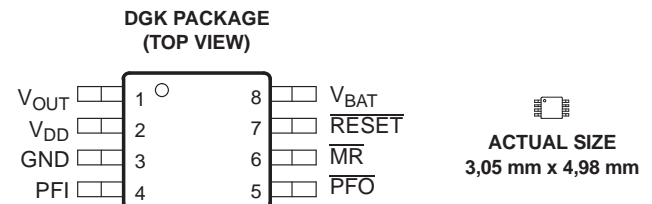

TYPICAL OPERATING CIRCUIT

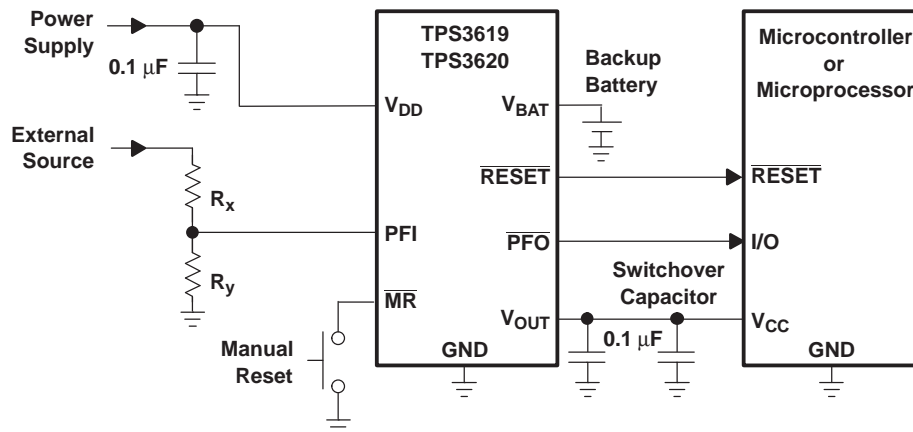

Please be aware that an important notice concerning availability, standard warranty, and use in critical applications of Texas Instruments semiconductor products and disclaimers thereto appears at the end of this data sheet.

All trademarks are the property of their respective owners.



This integrated circuit can be damaged by ESD. Texas Instruments recommends that all integrated circuits be handled with appropriate precautions. Failure to observe proper handling and installation procedures can cause damage.

ESD damage can range from subtle performance degradation to complete device failure. Precision integrated circuits may be more susceptible to damage because very small parametric changes could cause the device not to meet its published specifications.

PACKAGE INFORMATION⁽¹⁾

PRODUCT	SPECIFIED TEMPERATURE RANGE	PACKAGE MARKING	ORDERING NUMBER	TRANSPORT MEDIA, QUANTITY
TPS3619-33	-40°C to +85°C	AFL	TPS3619-33DGK	Tube, 80
			TPS3619-33DGKR	Tape and Reel, 2500
TPS3619-50		AFM	TPS3619-50DGK	Tube, 80
			TPS3619-50DGKR	Tape and Reel, 2500
TPS3620-33		ANL	TPS3620-33DGKT	Tape and Reel, 250
			TPS3620-33DGKR	Tape and Reel, 2500
TPS3620-50		ANM	TPS3620-50DGKT	Tape and Reel, 250
			TPS3620-50DGKR	Tape and Reel, 2500

(1) For the most current specifications and package information, see the Package Option Addendum located at the end of this data sheet or refer to our web site at www.ti.com.

STANDARD AND APPLICATION SPECIFIC VERSIONS

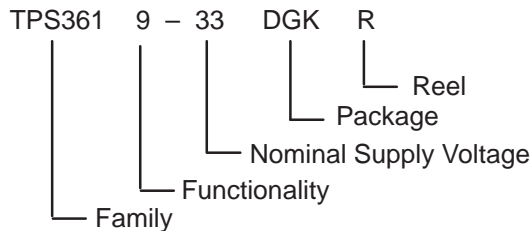

DEVICE NAME	NOMINAL VOLTAGE ⁽¹⁾ , V _{NOM}
TPS3619-33 DGK	3.3 V
TPS3619-50 DGK	5.0 V
TPS3620-33 DGK	3.3 V
TPS3620-50 DGK	5.0 V

(1) For other threshold voltage versions, contact the local TI sales office for availability and lead-time.

ABSOLUTE MAXIMUM RATINGS

Over operating free-air temperature (unless otherwise noted).⁽¹⁾

	UNIT	
Supply voltage:	V _{DD} ⁽²⁾	7 V
	MR and PFI pins ⁽²⁾	-0.3 V to (V _{DD} + 0.3 V)
Continuous output current:	V _{OUT} , I _O	400 mA
	All other pins, I _O ⁽²⁾	±10 mA
Continuous total power dissipation	See Dissipation Rating Table	
Operating free-air temperature range, T _A	-40°C to +85°C	
Storage temperature range, T _{stg}	-65°C to +150°C	
Lead temperature soldering 1,6 mm (1/16 inch) from case for 10 seconds	+260°C	

(1) Stresses beyond those listed under *absolute maximum ratings* may cause permanent damage to the device. These are stress ratings only, and functional operation of the device at these or any other conditions beyond those indicated under recommended operating conditions is not implied. Exposure to absolute-maximum-rated conditions for extended periods may affect device reliability.

(2) All voltage values are with respect to GND. For reliable operation, the device must not be operated at 7 V for more than t = 1000h continuously.

DISSIPATION RATING TABLE

PACKAGE	θ _{JC}	θ _{JA} (LOW-K)	θ _{JA} (HIGH-K)	T _A < 25°C POWER RATING	DERATING FACTOR ABOVE T _A = +25°C	T _A = +70°C POWER RATING	T _A = +85°C POWER RATING
DGK	55°C/W	266°C/W	180°C/W	470 mW	3.76 mW/°C	301 mW	241 mW

RECOMMENDED OPERATING CONDITIONS

At specified temperature range.

	MIN	MAX	UNIT
Supply voltage, V_{DD}	1.65	5.5	V
Battery supply voltage, V_{BAT}	1.5	5.5	V
Input voltage, V_I	0	$V_{DD} + 0.3$	V
High-level input voltage, V_{IH}	$0.7 \times V_{DD}$		V
Low-level input voltage, V_{IL}		$0.3 \times V_{DD}$	V
Continuous output current at V_{OUT} , I_O		300	mA
Input transition rise and fall rate at MR		100	ns/V
Slew rate at V_{DD} or V_{BAT} , $\Delta t/\Delta V$		1	V/ μ s
Operating free-air temperature range, T_A	-40	+85	$^{\circ}$ C

ELECTRICAL CHARACTERISTICS

Over recommended operating conditions (unless otherwise noted).

PARAMETER		TEST CONDITIONS	MIN	TYP	MAX	UNIT
V_{OH}	High-level output voltage	RESET $V_{DD} = 1.8$ V, $I_{OH} = -400$ μ A $V_{DD} = 3.3$ V, $I_{OH} = -2$ mA $V_{DD} = 5$ V, $I_{OH} = -3$ mA	$V_{DD} - 0.2$ V			V
			$V_{DD} - 0.4$ V			
			$V_{DD} - 0.4$ V			
	PFO $V_{DD} = 1.8$ V, $I_{OH} = -20$ μ A $V_{DD} = 3.3$ V, $I_{OH} = -80$ μ A $V_{DD} = 5$ V, $I_{OH} = -120$ μ A	$V_{DD} - 0.3$ V			V	
		$V_{DD} - 0.4$ V				
		$V_{DD} - 0.4$ V				
V_{OL}	Low-level output voltage	RESET PFO $V_{DD} = 1.8$ V, $I_{OL} = -400$ μ A $V_{DD} = 3.3$ V, $I_{OL} = 2$ mA $V_{DD} = 5$ V, $I_{OL} = 3$ mA			0.2	V
					0.4	
					0.4	
V_{res}	Power-up reset voltage (see (1))	$I_{OL} = 20$ μ A, $V_{BAT} > 1.1$ V or $V_{DD} > 1.1$ V			0.4	V
V_{OUT}	Normal mode	$I_{OUT} = 8.5$ mA, $V_{BAT} = 0$ V $V_{DD} = 1.8$ V $I_{OUT} = 125$ mA, $V_{BAT} = 0$ V $V_{DD} = 3.3$ V $I_{OUT} = 200$ mA, $V_{BAT} = 0$ V $V_{DD} = 5$ V	$V_{DD} - 50$ V			V
			$V_{DD} - 150$ V			
			$V_{DD} - 200$ V			
	Battery-backup mode	$I_{OUT} = 0.5$ mA, $V_{BAT} = 1.5$ V $V_{DD} = 0$ V $I_{OUT} = 7.5$ mA, $V_{BAT} = 3.3$ V	$V_{BAT} - 20$ mV			V
			$V_{BAT} - 113$ mV			
	$r_{DS(on)}$	V_{DD} to V_{OUT} on-resistance	$V_{DD} = 5$ V		0.6	1
V_{BAT} to V_{OUT} on-resistance		$V_{DD} = 3.3$ V		8	15	
V_{IT-}	Negative-going input threshold voltage (see (2))	TPS3619-33	$T_A = -40^{\circ}$ C to 85° C	2.88	2.93	3
V_{PFI}		TPS3619-50		4.46	4.55	4.64
		PFI		1.13	1.15	1.17
V_{hys}	Hysteresis	V_{IT}	1.65 V $< V_{IT} < 2.5$ V		20	mV
			2.5 V $< V_{IT} < 3.5$ V		40	
			3.5 V $< V_{IT} < 5.5$ V		60	
		PFI		12		
		VBSW (see (3))	$V_{DD} = 1.8$ V		55	

(1) The lowest supply voltage at which RESET becomes active. $t_{r,VDD} \geq 15$ μ s/V.

(2) To ensure the best stability of the threshold voltage, a bypass capacitor (ceramic, 0.1 μ F) should be placed near the supply terminals.

(3) For $V_{DD} < 1.6$ V, V_{OUT} switches to V_{BAT} regardless of V_{BAT} .

ELECTRICAL CHARACTERISTICS (continued)

Over recommended operating conditions (unless otherwise noted).

PARAMETER			TEST CONDITIONS		MIN	TYP	MAX	UNIT
I_{IH}	High-level input current	\overline{MR}	$\overline{MR} = 0.7 \times V_{DD}$	$V_{DD} = 5 \text{ V}$	-33		-76	μA
I_{IL}	Low-level input current		$\overline{MR} = 0 \text{ V}$		-110	-255		
I_I	Input current	PFI			-25		25	nA
I_{OS}	Short-circuit current	\overline{PFO}	$\overline{PFO} = 0 \text{ V}$	$V_{DD} = 1.8 \text{ V}$			-0.3	mA
				$V_{DD} = 3.3 \text{ V}$			-1.1	
				$V_{DD} = 5 \text{ V}$			-2.4	
I_{DD}	V_{DD} supply current		$V_{OUT} = V_{DD}$				40	μA
			$V_{OUT} = V_{BAT}$				40	
$I_{(BAT)}$	V_{BAT} supply current		$V_{OUT} = V_{DD}$		-0.1		0.1	μA
			$V_{OUT} = V_{BAT}$				0.5	
C_i	Input capacitance		$V_I = 0 \text{ V to } 5 \text{ V}$			5		pF

TIMING REQUIREMENTS

At $R_L = 1 \text{ M}\Omega$, $C_L = 50 \text{ pF}$, $T_A = -40^\circ\text{C}$ to $+85^\circ\text{C}$.

PARAMETER			TEST CONDITIONS		MIN	TYP	MAX	UNIT
t_w	Pulse width	at V_{DD}	$V_{IH} = V_{IT} + 0.2 \text{ V}$, $V_{IL} = V_{IT} - 0.2 \text{ V}$		6			μs
		at \overline{MR}	$V_{DD} = V_{IT} + 0.2 \text{ V}$, $V_{IL} = 0.3 \times V_{DD}$, $V_{IH} = 0.7 \times V_{DD}$		100			ns

SWITCHING CHARACTERISTICS

At $R_L = 1 \text{ M}\Omega$, $C_L = 50 \text{ pF}$, $T_A = -40^\circ\text{C}$ to $+85^\circ\text{C}$.

PARAMETER			TEST CONDITIONS		MIN	TYP	MAX	UNIT
t_d	Delay time		$V_{DD} \geq V_{IT} + 0.2 \text{ V}$, $\overline{MR} \geq 0.7 \times V_{DD}$ See timing diagram		60	100	140	ms
t_{PHL}	Propagation (delay) time, high-to-low level output	V_{DD} to RESET	$V_{IL} = V_{IT} - 0.2 \text{ V}$, $V_{IH} = V_{IT} + 0.2 \text{ V}$			2	5	μs
		PFI to \overline{PFO} delay	$V_{IL} = V_{PFI} - 0.2 \text{ V}$, $V_{IH} = V_{PFI} + 0.2 \text{ V}$			3	5	
		\overline{MR} to RESET	$V_{DD} \geq V_{IT} + 0.2 \text{ V}$, $V_{IL} = 0.3 \times V_{DD}$, $V_{IH} = 0.7 \times V_{DD}$			0.1	1	

TIMING DIAGRAM

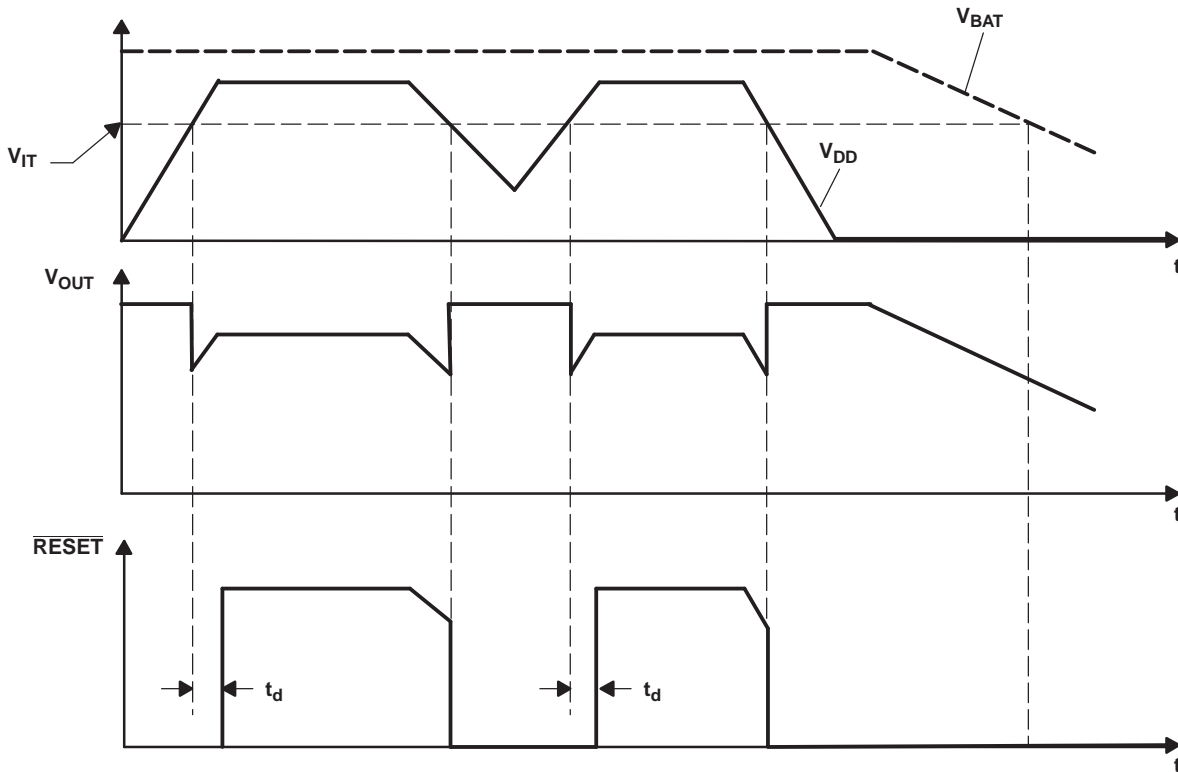

Table 1. FUNCTION TABLE

$V_{DD} > V_{IT}$	$V_{DD} > V_{BAT}$	MR	V_{OUT}	RESET
0	0	0	V_{BAT}	0
0	0	1	V_{BAT}	0
0	1	0	V_{DD}	0
0	1	1	V_{DD}	0
1	0	0	V_{DD}	0
1	0	1	V_{DD}	1
1	1	0	V_{DD}	0
1	1	1	V_{DD}	1

$PFI > V_{PFI}$	PFO
0	0
1	1

CONDITION.: $V_{DD} > V_{DD_MIN}$

Table 2. TERMINAL FUNCTIONS

TERMINAL		I/O	DESCRIPTION
NAME	NO.		
GND	3	I	Ground
$\overline{\text{MR}}$	6	I	Manual reset input
PFI	4	I	Power-fail comparator input
$\overline{\text{PFO}}$	5	O	Power-fail comparator output
$\overline{\text{RESET}}$	7	O	Active-low reset output
V_{BAT}	8	I	Backup-battery input
V_{DD}	2	I	Input supply voltage
V_{OUT}	1	O	Supply output

FUNCTIONAL BLOCK DIAGRAM

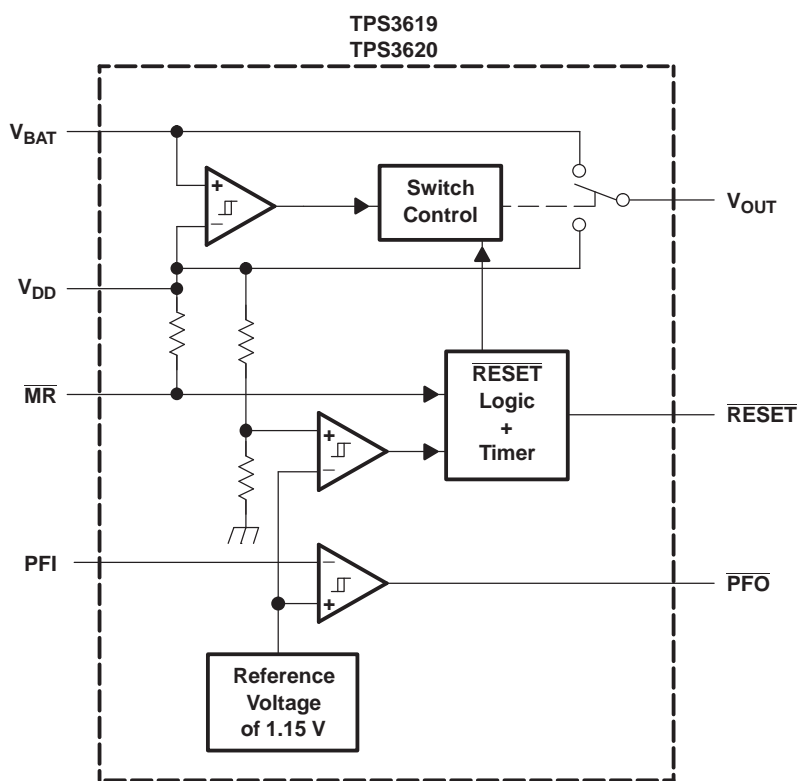

TYPICAL CHARACTERISTICS

**STATIC DRAIN-SOURCE ON-STATE RESISTANCE
 (V_{DD} to V_{OUT})
 vs
 OUTPUT CURRENT**

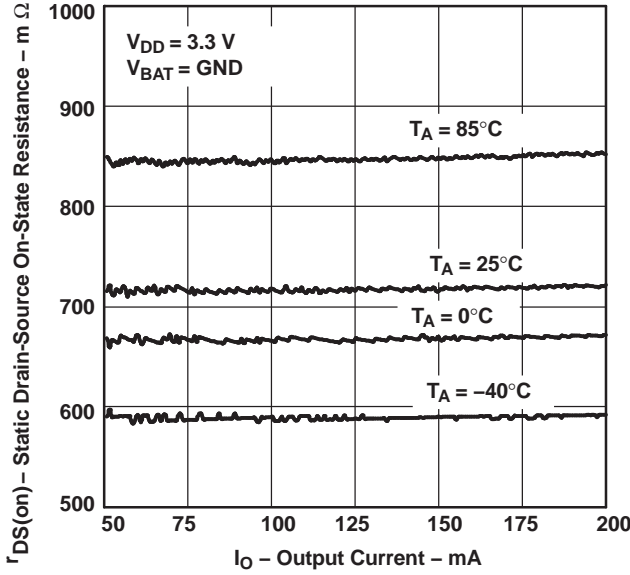

Figure 1.

**STATIC DRAIN-SOURCE ON-STATE RESISTANCE
 (V_{BAT} to V_{OUT})
 vs
 OUTPUT CURRENT**

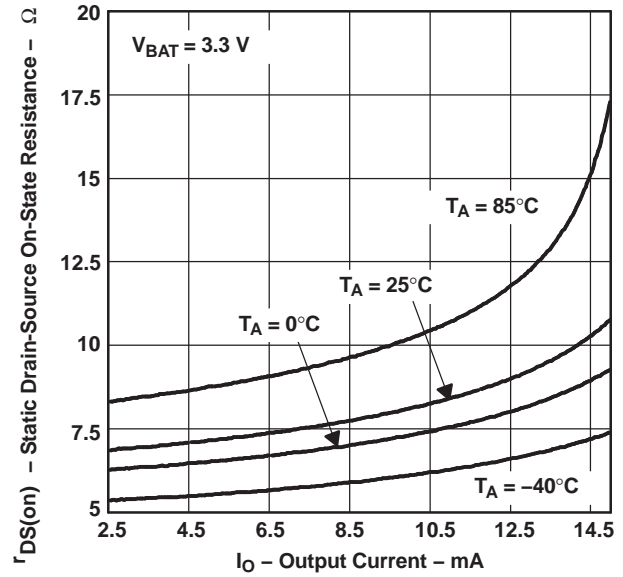

Figure 2.

**SUPPLY CURRENT
 vs
 SUPPLY VOLTAGE**

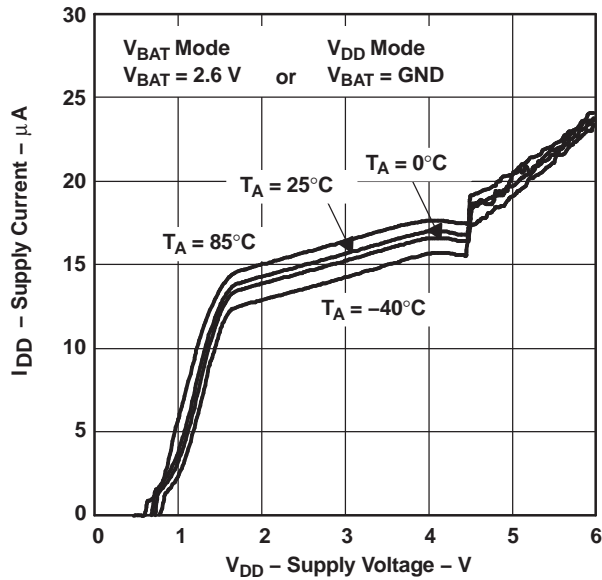

Figure 3.

**NORMALIZED THRESHOLD AT RESET
 vs
 FREE-AIR TEMPERATURE**

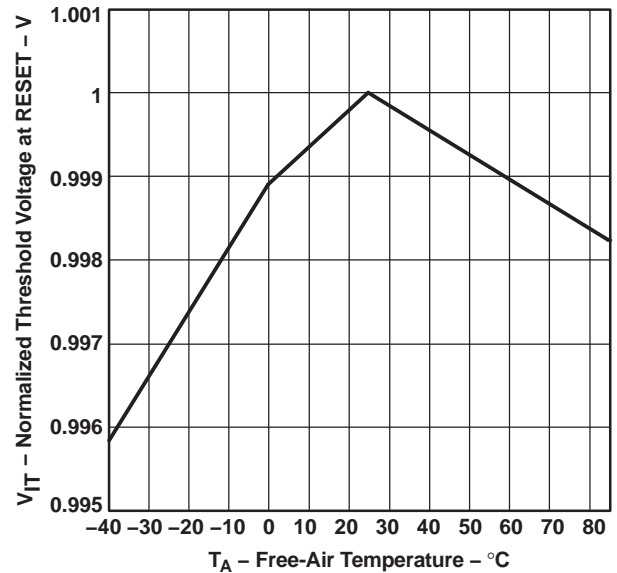
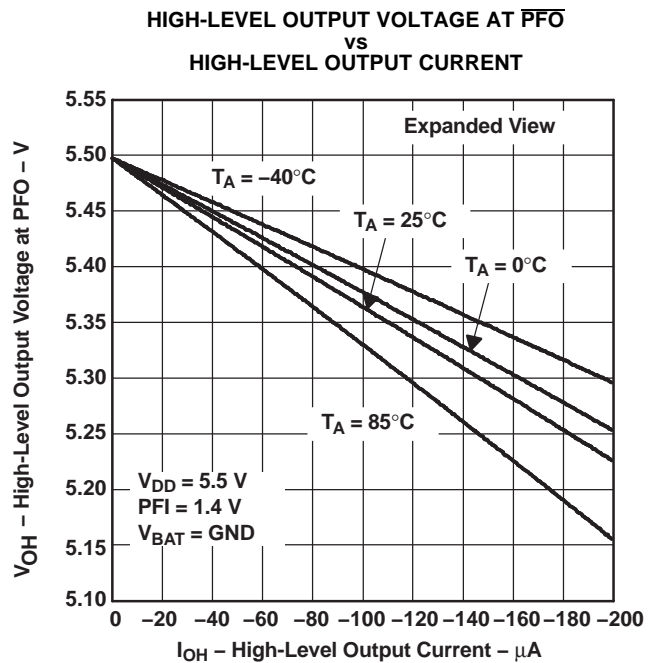
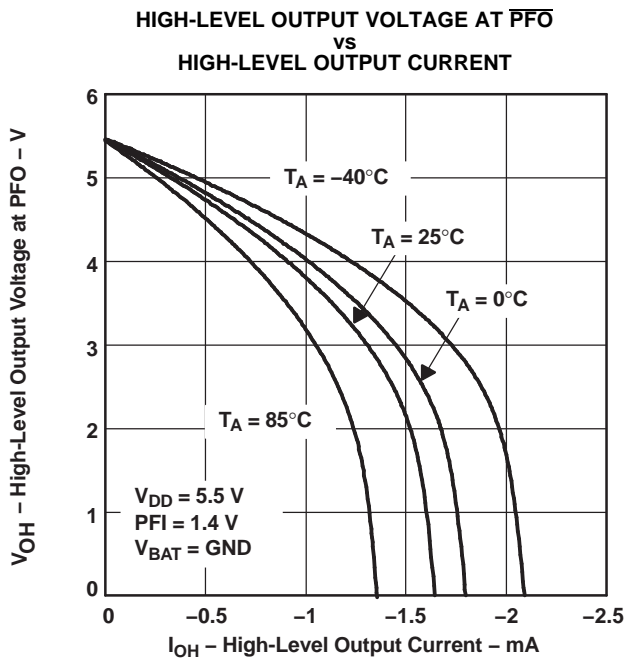
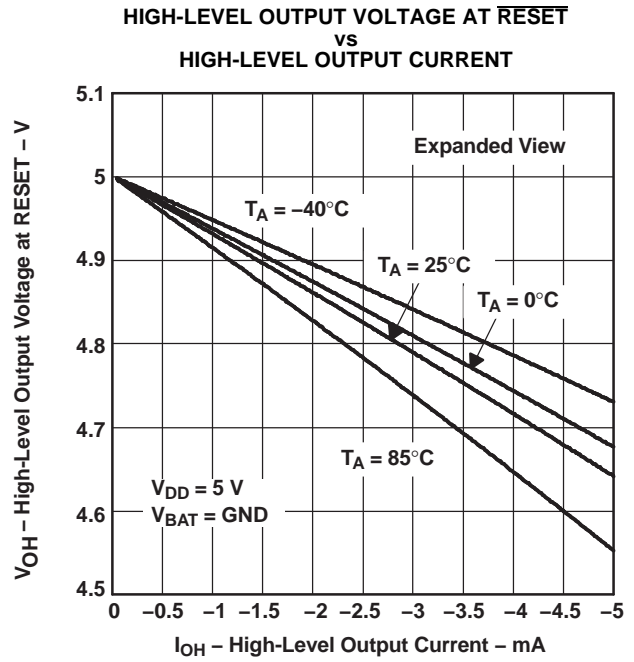
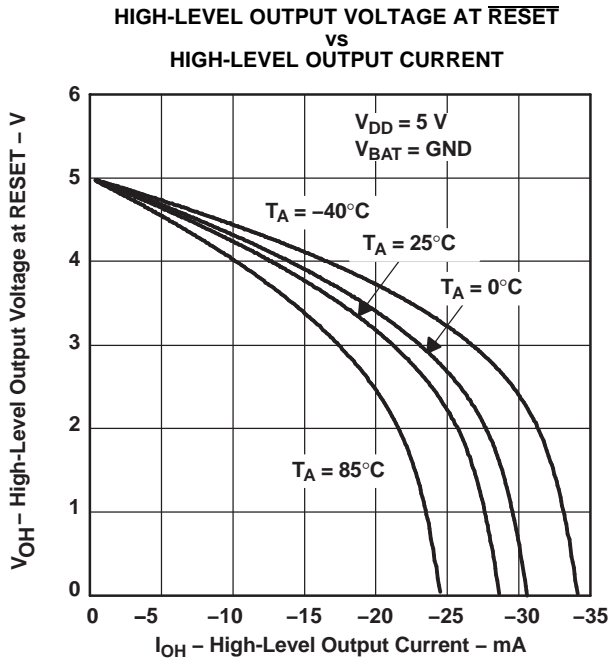

Figure 4.

TYPICAL CHARACTERISTICS (continued)



TYPICAL CHARACTERISTICS (continued)

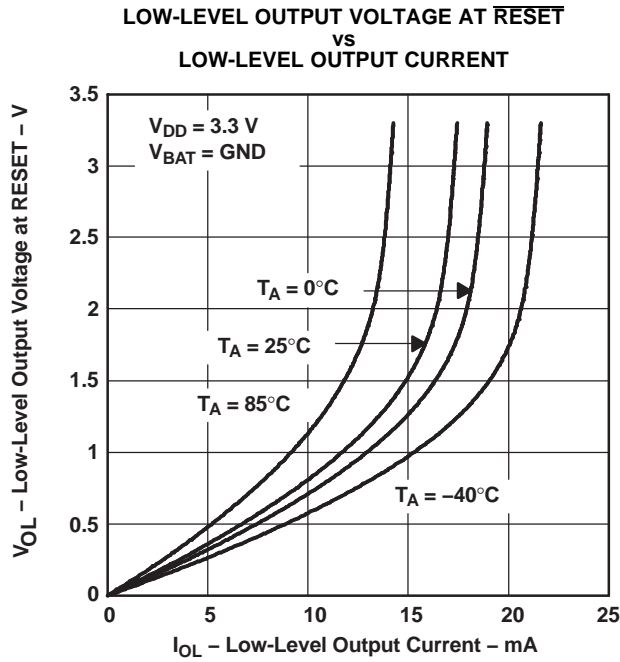

Figure 9.

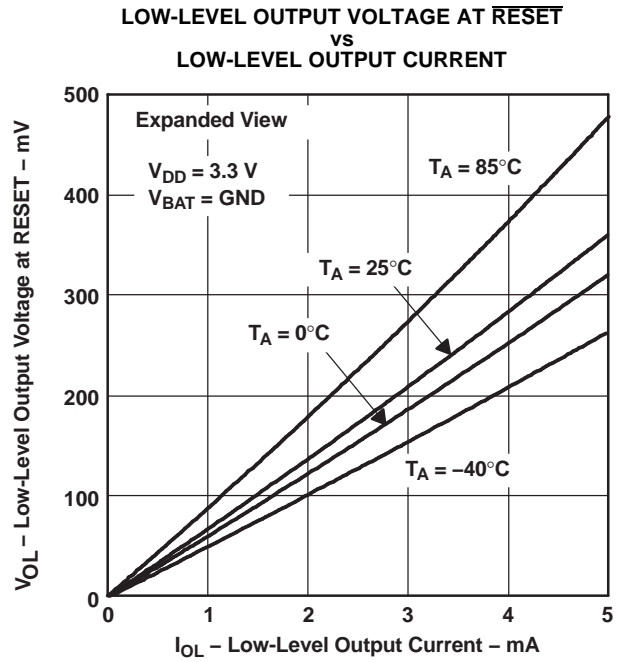

Figure 10.

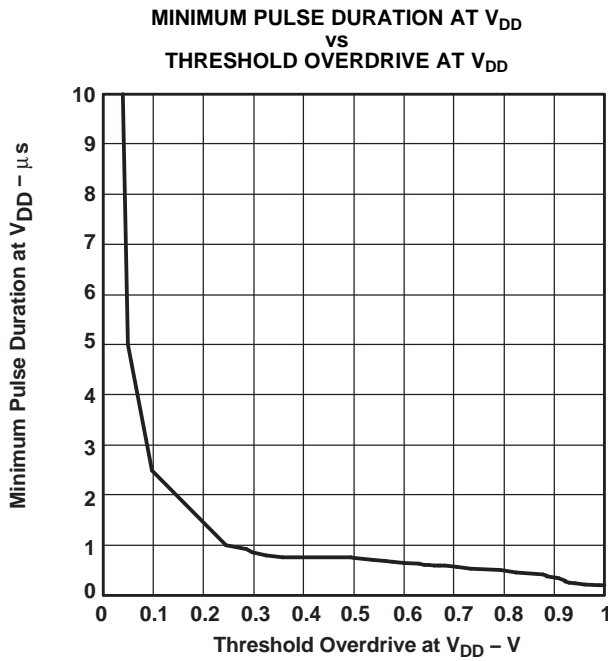

Figure 11.

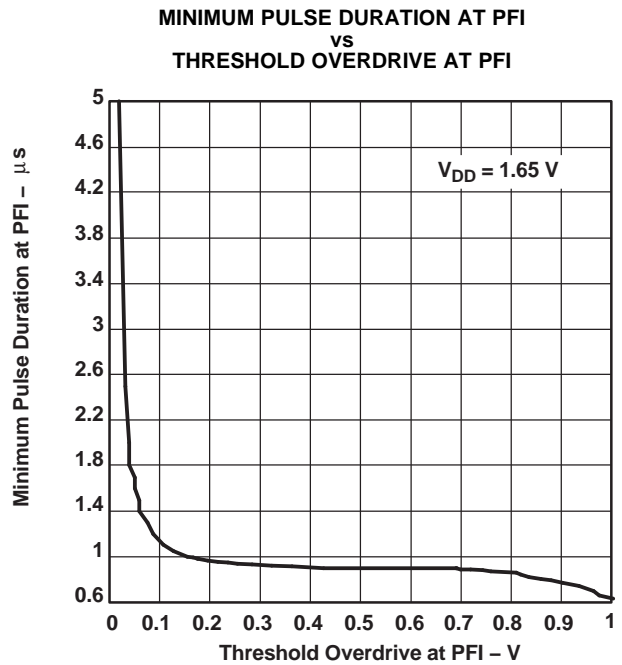

Figure 12.

DETAILED DESCRIPTION

Battery Freshness Seal (TPS3619)

The battery freshness seal of the TPS3619 family disconnects the backup-battery from internal circuitry until it is needed. This function prevents the backup-battery from being discharged until the final product is put to use. The following steps explain how to enable the freshness seal mode.

1. Connect V_{BAT} ($V_{BAT} > V_{BAT\ min}$)
2. Ground \overline{PFO}
3. Connect PFI to V_{DD} ($PFI = V_{DD}$)
4. Connect V_{DD} to power supply ($V_{DD} > V_{IT}$) and keep connected for $5\ ms < t < 35\ ms$

The battery freshness seal mode is automatically removed by the positive-going edge of \overline{RESET} when V_{DD} is applied.

Power-Fail Comparator (PFI and \overline{PFO})

An additional comparator is provided to monitor voltages other than the nominal supply voltage. The power-fail-input (PFI) is compared with an internal voltage reference of 1.15 V. If the input voltage falls below the power-fail threshold $V_{IT(PFI)}$ of typical 1.15 V, the power-fail output (\overline{PFO}) goes low. If $V_{IT(PFI)}$ goes above $V_{(PFI)}$, plus about 12-mV hysteresis, the output returns to high. By connecting two external resistors, it is possible to supervise any voltages above $V_{(PFI)}$. The sum of both resistors should be about 1 M Ω , to minimize power consumption and also to assure that the current in the PFI pin can be ignored compared with the current through the resistor network. The tolerance of the external resistors should be not more than 1% to ensure minimal variation of sensed voltage. If the power-fail comparator is unused, PFI should be connected to ground and \overline{PFO} left unconnected.

Backup-Battery Switchover

In case of a brownout or power failure, it may be necessary to preserve the contents of RAM. If a backup battery is installed at V_{BAT} , the device automatically switches the connected RAM to backup power when V_{DD} fails. In order to allow the backup battery (e.g., a 3.6-V lithium cell) to have a higher voltage than V_{DD} , these supervisors do not connect V_{BAT} to V_{OUT} when V_{BAT} is greater than V_{DD} . V_{BAT} only connects to V_{OUT} (through a 15- Ω switch) when V_{DD} falls below V_{IT} and V_{BAT} is greater than V_{DD} . When V_{DD} recovers, switchover is deferred either until V_{DD} crosses V_{BAT} , or until V_{DD} rises above the reset threshold V_{IT} . V_{OUT} connects to V_{DD} through a 1- Ω (max) PMOS switch when V_{DD} crosses the reset threshold.

FUNCTION TABLE		
$V_{DD} > V_{BAT}$	$V_{DD} > V_{IT}$	V_{OUT}
1	1	V_{DD}
1	0	V_{DD}
0	1	V_{DD}
0	0	V_{BAT}

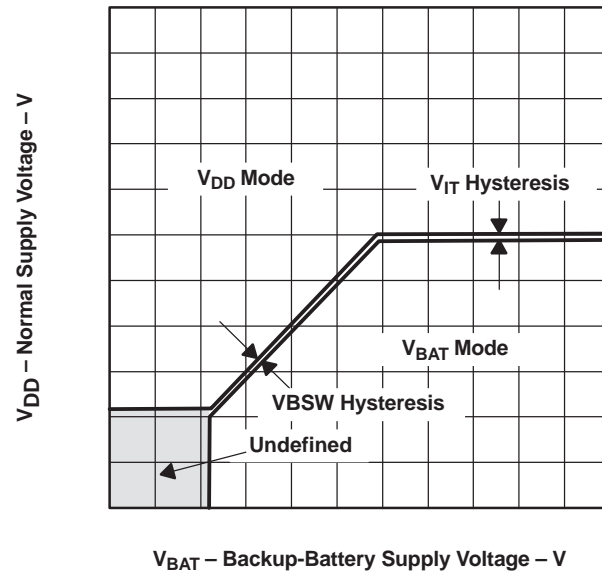

Figure 13. Normal Supply Voltage vs Backup-Battery Supply Voltage

PACKAGING INFORMATION

Orderable Device	Status ⁽¹⁾	Package Type	Package Drawing	Pins	Package Qty	Eco Plan ⁽²⁾	Lead/Ball Finish	MSL Peak Temp ⁽³⁾
TPS3619-33DGK	ACTIVE	MSOP	DGK	8	80	Green (RoHS & no Sb/Br)	CU NIPDAU	Level-1-260C-UNLIM
TPS3619-33DGKG4	ACTIVE	MSOP	DGK	8	80	Green (RoHS & no Sb/Br)	CU NIPDAU	Level-1-260C-UNLIM
TPS3619-33DGKR	ACTIVE	MSOP	DGK	8	2500	Green (RoHS & no Sb/Br)	CU NIPDAU	Level-1-260C-UNLIM
TPS3619-33DGKRG4	ACTIVE	MSOP	DGK	8	2500	Green (RoHS & no Sb/Br)	CU NIPDAU	Level-1-260C-UNLIM
TPS3619-50DGK	ACTIVE	MSOP	DGK	8	80	Green (RoHS & no Sb/Br)	CU NIPDAU	Level-1-260C-UNLIM
TPS3619-50DGKG4	ACTIVE	MSOP	DGK	8	80	Green (RoHS & no Sb/Br)	CU NIPDAU	Level-1-260C-UNLIM
TPS3619-50DGKR	ACTIVE	MSOP	DGK	8	2500	Green (RoHS & no Sb/Br)	CU NIPDAU	Level-1-260C-UNLIM
TPS3619-50DGKRG4	ACTIVE	MSOP	DGK	8	2500	Green (RoHS & no Sb/Br)	CU NIPDAU	Level-1-260C-UNLIM
TPS3620-33DGKR	ACTIVE	MSOP	DGK	8	2500	Green (RoHS & no Sb/Br)	CU NIPDAU	Level-1-260C-UNLIM
TPS3620-33DGKRG4	ACTIVE	MSOP	DGK	8	2500	Green (RoHS & no Sb/Br)	CU NIPDAU	Level-1-260C-UNLIM
TPS3620-33DGKGT	ACTIVE	MSOP	DGK	8	250	Green (RoHS & no Sb/Br)	CU NIPDAU	Level-1-260C-UNLIM
TPS3620-33DGKGTG4	ACTIVE	MSOP	DGK	8	250	Green (RoHS & no Sb/Br)	CU NIPDAU	Level-1-260C-UNLIM
TPS3620-50DGKR	ACTIVE	MSOP	DGK	8	2500	Green (RoHS & no Sb/Br)	CU NIPDAU	Level-1-260C-UNLIM
TPS3620-50DGKRG4	ACTIVE	MSOP	DGK	8	2500	Green (RoHS & no Sb/Br)	CU NIPDAU	Level-1-260C-UNLIM
TPS3620-50DGKGT	ACTIVE	MSOP	DGK	8	250	Green (RoHS & no Sb/Br)	CU NIPDAU	Level-1-260C-UNLIM
TPS3620-50DGKGTG4	ACTIVE	MSOP	DGK	8	250	Green (RoHS & no Sb/Br)	CU NIPDAU	Level-1-260C-UNLIM

⁽¹⁾ The marketing status values are defined as follows:

ACTIVE: Product device recommended for new designs.

LIFEBUY: TI has announced that the device will be discontinued, and a lifetime-buy period is in effect.

NRND: Not recommended for new designs. Device is in production to support existing customers, but TI does not recommend using this part in a new design.

PREVIEW: Device has been announced but is not in production. Samples may or may not be available.

OBSOLETE: TI has discontinued the production of the device.

⁽²⁾ Eco Plan - The planned eco-friendly classification: Pb-Free (RoHS), Pb-Free (RoHS Exempt), or Green (RoHS & no Sb/Br) - please check <http://www.ti.com/productcontent> for the latest availability information and additional product content details.

TBD: The Pb-Free/Green conversion plan has not been defined.

Pb-Free (RoHS): TI's terms "Lead-Free" or "Pb-Free" mean semiconductor products that are compatible with the current RoHS requirements for all 6 substances, including the requirement that lead not exceed 0.1% by weight in homogeneous materials. Where designed to be soldered at high temperatures, TI Pb-Free products are suitable for use in specified lead-free processes.

Pb-Free (RoHS Exempt): This component has a RoHS exemption for either 1) lead-based flip-chip solder bumps used between the die and package, or 2) lead-based die adhesive used between the die and leadframe. The component is otherwise considered Pb-Free (RoHS compatible) as defined above.

Green (RoHS & no Sb/Br): TI defines "Green" to mean Pb-Free (RoHS compatible), and free of Bromine (Br) and Antimony (Sb) based flame retardants (Br or Sb do not exceed 0.1% by weight in homogeneous material)

⁽³⁾ MSL, Peak Temp. -- The Moisture Sensitivity Level rating according to the JEDEC industry standard classifications, and peak solder temperature.

Important Information and Disclaimer:The information provided on this page represents TI's knowledge and belief as of the date that it is provided. TI bases its knowledge and belief on information provided by third parties, and makes no representation or warranty as to the accuracy of such information. Efforts are underway to better integrate information from third parties. TI has taken and continues to take reasonable steps to provide representative and accurate information but may not have conducted destructive testing or chemical analysis on incoming materials and chemicals. TI and TI suppliers consider certain information to be proprietary, and thus CAS numbers and other limited information may not be available for release.

In no event shall TI's liability arising out of such information exceed the total purchase price of the TI part(s) at issue in this document sold by TI to Customer on an annual basis.

TAPE AND REEL BOX INFORMATION

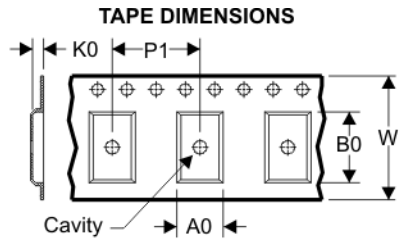
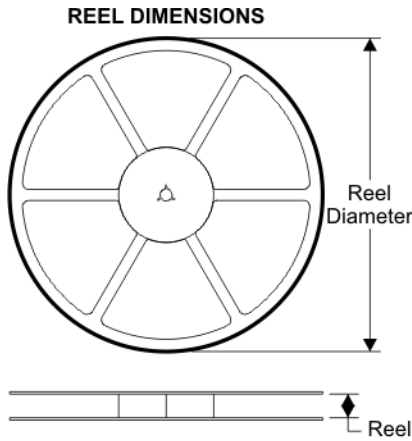

A0	Dimension designed to accommodate the component width
B0	Dimension designed to accommodate the component length
K0	Dimension designed to accommodate the component thickness
W	Overall width of the carrier tape
P1	Pitch between successive cavity centers

QUADRANT ASSIGNMENTS FOR PIN 1 ORIENTATION IN TAPE

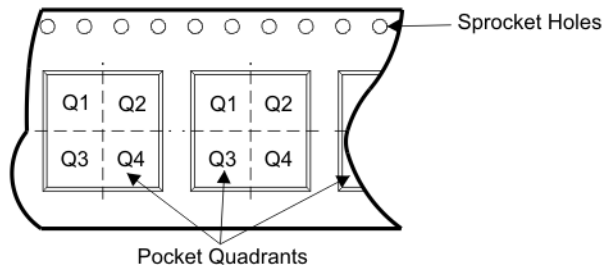

Device	Package	Pins	Site	Reel Diameter (mm)	Reel Width (mm)	A0 (mm)	B0 (mm)	K0 (mm)	P1 (mm)	W (mm)	Pin1 Quadrant
TPS3619-33DGKR	DGK	8	SITE 35	330	12	5.3	3.4	1.4	8	12	Q1
TPS3619-50DGKR	DGK	8	SITE 35	330	12	5.3	3.4	1.4	8	12	Q1
TPS3620-33DGKR	DGK	8	SITE 35	330	12	5.3	3.4	1.4	8	12	Q1
TPS3620-33DGKT	DGK	8	SITE 35	330	12	5.3	3.4	1.4	8	12	Q1
TPS3620-50DGKR	DGK	8	SITE 35	330	12	5.3	3.4	1.4	8	12	Q1
TPS3620-50DGKT	DGK	8	SITE 35	330	12	5.3	3.4	1.4	8	12	Q1

TAPE AND REEL BOX DIMENSIONS



Device	Package	Pins	Site	Length (mm)	Width (mm)	Height (mm)
TPS3619-33DGKR	DGK	8	SITE 35	358.0	335.0	0.0
TPS3619-50DGKR	DGK	8	SITE 35	358.0	335.0	0.0
TPS3620-33DGKR	DGK	8	SITE 35	358.0	335.0	0.0
TPS3620-33DGKT	DGK	8	SITE 35	0.0	0.0	0.0
TPS3620-50DGKR	DGK	8	SITE 35	358.0	335.0	0.0
TPS3620-50DGKT	DGK	8	SITE 35	0.0	0.0	0.0

DGK (S-PDSO-G8)

PLASTIC SMALL-OUTLINE PACKAGE

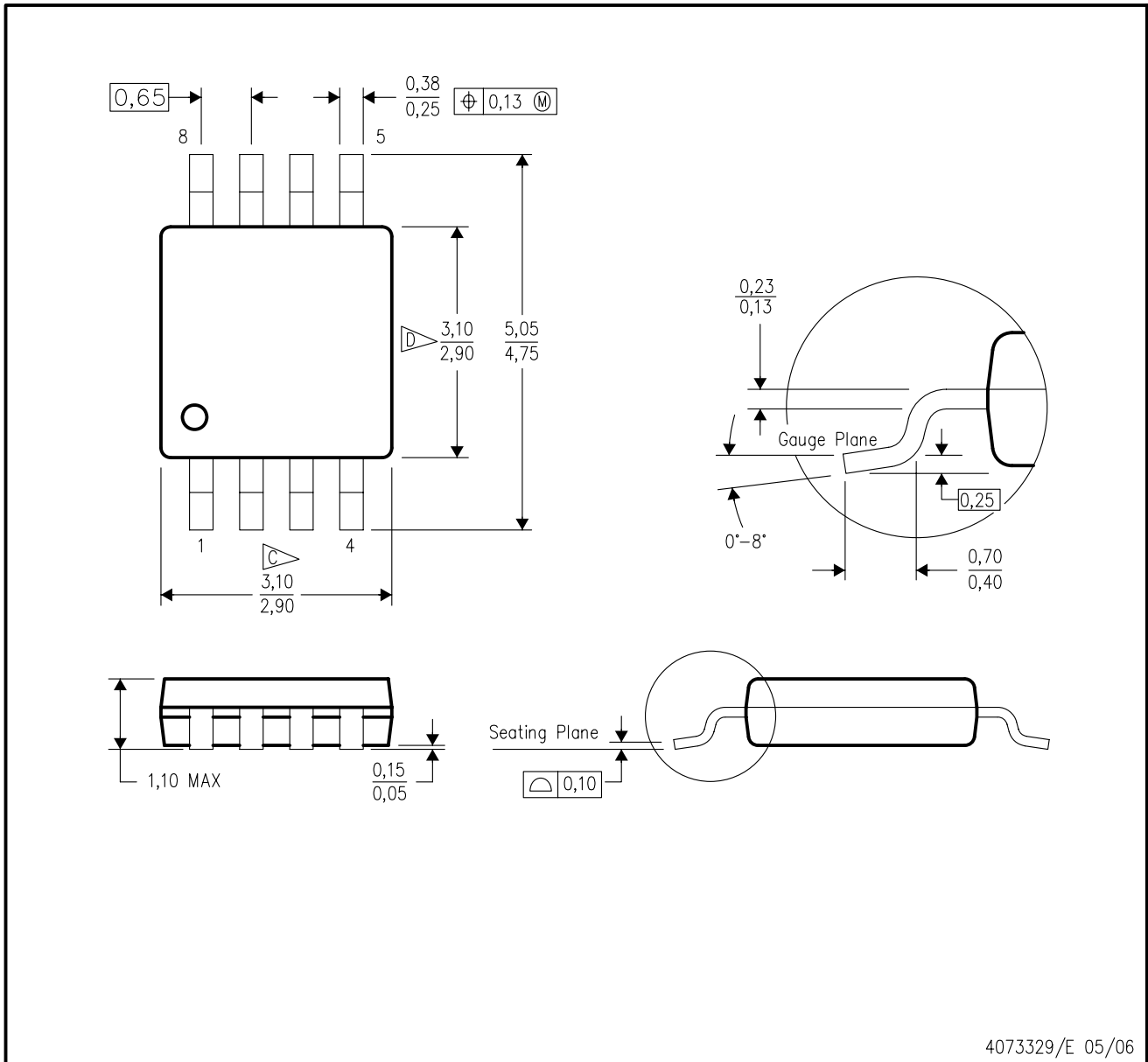

- NOTES:
- A. All linear dimensions are in millimeters.
 - B. This drawing is subject to change without notice.
 - C. Body length does not include mold flash, protrusions, or gate burrs. Mold flash, protrusions, or gate burrs shall not exceed 0.15 per end.
 - D. Body width does not include interlead flash. Interlead flash shall not exceed 0.50 per side.
 - E. Falls within JEDEC MO-187 variation AA, except interlead flash.

IMPORTANT NOTICE

Texas Instruments Incorporated and its subsidiaries (TI) reserve the right to make corrections, modifications, enhancements, improvements, and other changes to its products and services at any time and to discontinue any product or service without notice. Customers should obtain the latest relevant information before placing orders and should verify that such information is current and complete. All products are sold subject to TI's terms and conditions of sale supplied at the time of order acknowledgment.

TI warrants performance of its hardware products to the specifications applicable at the time of sale in accordance with TI's standard warranty. Testing and other quality control techniques are used to the extent TI deems necessary to support this warranty. Except where mandated by government requirements, testing of all parameters of each product is not necessarily performed.

TI assumes no liability for applications assistance or customer product design. Customers are responsible for their products and applications using TI components. To minimize the risks associated with customer products and applications, customers should provide adequate design and operating safeguards.

TI does not warrant or represent that any license, either express or implied, is granted under any TI patent right, copyright, mask work right, or other TI intellectual property right relating to any combination, machine, or process in which TI products or services are used. Information published by TI regarding third-party products or services does not constitute a license from TI to use such products or services or a warranty or endorsement thereof. Use of such information may require a license from a third party under the patents or other intellectual property of the third party, or a license from TI under the patents or other intellectual property of TI.

Reproduction of TI information in TI data books or data sheets is permissible only if reproduction is without alteration and is accompanied by all associated warranties, conditions, limitations, and notices. Reproduction of this information with alteration is an unfair and deceptive business practice. TI is not responsible or liable for such altered documentation. Information of third parties may be subject to additional restrictions.

Resale of TI products or services with statements different from or beyond the parameters stated by TI for that product or service voids all express and any implied warranties for the associated TI product or service and is an unfair and deceptive business practice. TI is not responsible or liable for any such statements.

TI products are not authorized for use in safety-critical applications (such as life support) where a failure of the TI product would reasonably be expected to cause severe personal injury or death, unless officers of the parties have executed an agreement specifically governing such use. Buyers represent that they have all necessary expertise in the safety and regulatory ramifications of their applications, and acknowledge and agree that they are solely responsible for all legal, regulatory and safety-related requirements concerning their products and any use of TI products in such safety-critical applications, notwithstanding any applications-related information or support that may be provided by TI. Further, Buyers must fully indemnify TI and its representatives against any damages arising out of the use of TI products in such safety-critical applications.

TI products are neither designed nor intended for use in military/aerospace applications or environments unless the TI products are specifically designated by TI as military-grade or "enhanced plastic." Only products designated by TI as military-grade meet military specifications. Buyers acknowledge and agree that any such use of TI products which TI has not designated as military-grade is solely at the Buyer's risk, and that they are solely responsible for compliance with all legal and regulatory requirements in connection with such use.

TI products are neither designed nor intended for use in automotive applications or environments unless the specific TI products are designated by TI as compliant with ISO/TS 16949 requirements. Buyers acknowledge and agree that, if they use any non-designated products in automotive applications, TI will not be responsible for any failure to meet such requirements.

Following are URLs where you can obtain information on other Texas Instruments products and application solutions:

Products		Applications	
Amplifiers	amplifier.ti.com	Audio	www.ti.com/audio
Data Converters	dataconverter.ti.com	Automotive	www.ti.com/automotive
DSP	dsp.ti.com	Broadband	www.ti.com/broadband
Interface	interface.ti.com	Digital Control	www.ti.com/digitalcontrol
Logic	logic.ti.com	Military	www.ti.com/military
Power Mgmt	power.ti.com	Optical Networking	www.ti.com/opticalnetwork
Microcontrollers	microcontroller.ti.com	Security	www.ti.com/security
RFID	www.ti-rfid.com	Telephony	www.ti.com/telephony
Low Power Wireless	www.ti.com/lpw	Video & Imaging	www.ti.com/video
		Wireless	www.ti.com/wireless

Mailing Address: Texas Instruments, Post Office Box 655303, Dallas, Texas 75265
Copyright © 2007, Texas Instruments Incorporated