

IEC Appliance Inlet C14 with Circuit Breaker TA45



Screw-on from front side  
 Rocker non-illuminated  
 white



Screw-on from front side  
 Rocker illuminated  
 green



See below:  
[Approvals and Compliances](#)

**Description**

- Panel mount :  
 Screw-on mounting from front side
- 2 Functions :  
 Appliance Inlet Protection class I , circuit breaker type TA45 2-pole
- Quick connect terminals 6.3 x 0.8 mm

**Characteristics**

- All single elements are already wired
- Unwired versions available on request
- Circuit Breaker non-illuminated or illuminated
- Suitable for use in equipment according to IEC/UL 60950

**References**

Alternative: version with line filter [5145](#)  
 We recommend for new applications [DF11](#)

**Weblinks**

[pdf data sheet](#), [html datasheet](#), [General Product Information](#), [Distributor-Stock-Check](#), [Accessories](#), [Detailed request for product](#), [Landing Page](#)

Newly available variants corresponding to V-Lock mating cordset. The connector is equipped with a notch intended for use with the latching cordset. The cord latching system prevents against accidental removal of the cordset.

**Technical Data**

Ratings IEC	10A / 250VAC; 50Hz	appliance inlet/-outlet	C14 acc. to IEC 60320-1, UL 60320-1, CSA C22.2 no. 60320-1 (for cold conditions) pin-temperature 70 °C, 10A, Protection Class I
Ratings UL/CSA	15A / 250VAC; 60Hz	Circuit Breakers	Acc. IEC/EN 60934, UL 1077, CSA 22.2 no. 235
Dielectric Strength	> 1.5kVAC between L/N-PE (1 min/50Hz)		2-pole rocker switch, illuminated or non-illuminated. Optional with undervoltage- or remote trip release
Allowable Operation Temperature	-10°C to 55°C		Short circuit capacity Icn: at In < 3A/240VAC : 10 x In at In ≥ 3A/240VAC : 300A
IP-Protection	from front side IP40 acc. to IEC 60529		
Protection against electric shock	Suitable for appliances with protection class I acc. to IEC 61140		
Terminal	Quick connect terminals 6.3 x 0.8 mm		
Panel Thickness S	Screw: max 6 mm Mounting screw torque max 0.5 Nm		
Material: Housing	Thermoplastic, black, UL 94V-0		

**Approvals and Compliances**

Detailed information on product approvals, code requirements, usage instructions and detailed test conditions can be looked up in [Details about Approvals](#)

SCHURTER products are designed for use in industrial environments. They have approvals from independent testing bodies according to national and international standards. Products with specific characteristics and requirements such as required in the automotive sector according to IATF 16949, medical technology according to ISO 13485 or in the aerospace industry can be offered exclusively with customer-specific, individual agreements by SCHURTER.



**Approvals**

The approval mark is used by the testing authorities to certify compliance with the safety requirements placed on electronic products.  
 Approval Reference Type: 6145

Approval Logo	Certificates	Certification Body	Description
	<a href="#">VDE Approvals</a>	VDE	VDE Certificate Number: 40040061
	<a href="#">UL Approvals</a>	UL	UL File Number: E96454

**Product standards**

Product standards that are referenced

Organization	Design	Standard	Description
	Designed according to	IEC 60320-1	Appliance couplers for household and similar general purposes
	Designed according to	UL 60320-1	Standard for Attachment Plugs and Receptacles
	Designed according to	CSA C22.2 no. 60320-1	General Use Receptacles, Attachment Plugs, and Similar Wiring Devices





**Application standards**

Application standards where the product can be used

Organization	Design	Standard	Description
	Designed for applications acc.	IEC/UL 60950	IEC 60950-1 includes the basic requirements for the safety of information technology equipment.

**Compliances**

The product complies with following Guide Lines

Identification	Details	Initiator	Description
	<a href="#">CE declaration of conformity</a>	SCHURTER AG	The CE marking declares that the product complies with the applicable requirements laid down in the harmonisation of Community legislation on its affixing in accordance with EU Regulation 765/2008.
	RoHS	SCHURTER AG	Directive RoHS 2011/65/EU, Amendment (EU) 2015/863
	China RoHS	SCHURTER AG	The law SJ / T 11363-2006 (China RoHS) has been in force since 1 March 2007. It is similar to the EU directive RoHS.
	REACH	SCHURTER AG	On 1 June 2007, Regulation (EC) No 1907/2006 on the Registration, Evaluation, Authorization and Restriction of Chemicals 1 (abbreviated as "REACH") entered into force.

**Dimensions [mm]**

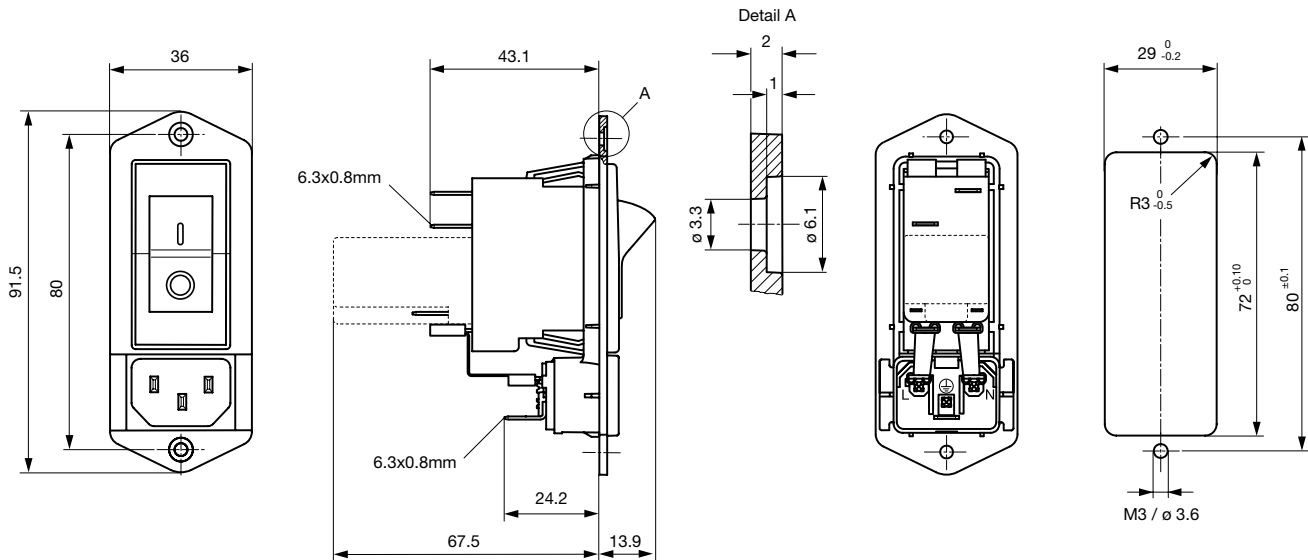

\* --- Version TA45 with undervoltage release

Diagrams

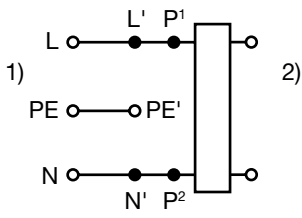

- 1) Line
- 2) Load

Time-Current-Curves

Tripping Characteristics  $I_n < 3 A$

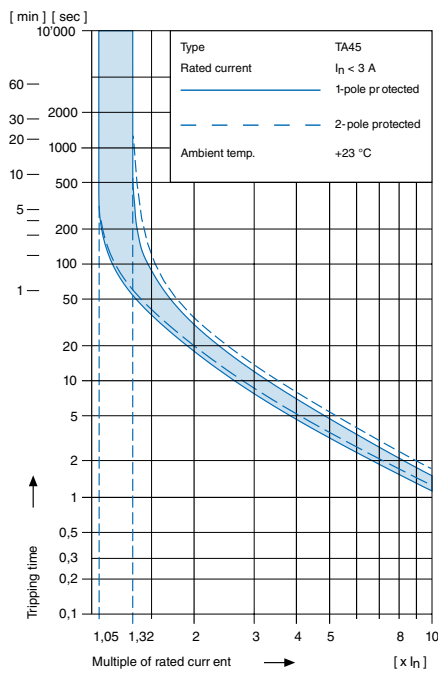

Tripping Characteristics  $I_n \geq 3 \dots \leq 15 A$

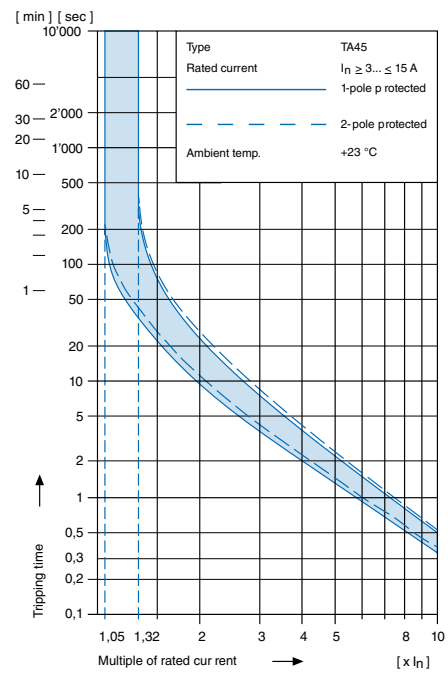

Configuration code TA45

Type	Configuration code TA45												
6145	A	B	T	W	F	1	5	C	0	-	0	0	0

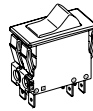

- Circuit Breaker of Equipment
- 2-pole, rocker actuated
- Quick connect terminal
- Other types on request

**Without release: code C0**

**Undervoltage release**

•	•	•
•	•	•
•	•	•

**Remote trip release**

•	<b>2</b>	240 V AC
•	<b>3</b>	230 V AC
•	<b>4</b>	120 V AC

**Rated current circuit breaker of equipment**

$I_n$	Code	$I_n$	Code	$I_n$	Code	$I_n$	Code
0,1	<b>J01</b>	1,3	<b>J13</b>	2,8	<b>J28</b>	10,0	<b>100</b>
0,2	<b>J02</b>	1,4	<b>J14</b>	3,0	<b>030</b>	11,0	<b>110</b>
0,3	<b>J03</b>	1,5	<b>J15</b>	3,5	<b>035</b>	12,0	<b>120</b>
0,4	<b>J04</b>	1,6	<b>J16</b>	4,0	<b>040</b>	13,0	<b>130</b>
0,5	<b>J05</b>	1,7	<b>J17</b>	4,5	<b>045</b>	14,0	<b>140</b>
0,6	<b>J06</b>	1,8	<b>J18</b>	5,0	<b>050</b>	15,0	<b>150</b>
0,7	<b>J07</b>	1,9	<b>J19</b>	6,0	<b>060</b>	20,0	<b>200</b>
0,8	<b>J08</b>	2,0	<b>J20</b>	6,5	<b>065</b>		
0,9	<b>J09</b>	2,1	<b>J21</b>	7,0	<b>070</b>		
1,0	<b>J10</b>	2,2	<b>J22</b>	7,5	<b>075</b>		
1,1	<b>J11</b>	2,3	<b>J23</b>	8,0	<b>080</b>		
1,2	<b>J12</b>	2,5	<b>J25</b>	9,0	<b>090</b>		

**Rocker legend**

	Surface	Illustration	Colour of print	Position of the rocker legend e.g F
<b>F</b>	embossed	— ○		
<b>H</b>	printed	ON OFF	white	
<b>K</b>	printed	ON OFF	black	
<b>L</b>	printed	— ○	white	
<b>M</b>	printed	— ○	black	
<b>P</b>	printed	I ○	white	
<b>R</b>	printed	I ○	black	

**Colours**

Switch front	Rocker
<b>W</b> black	white
<b>B</b> black	black
<b>6</b> black	— orange transp.

**Diagram**

Thermal overload protection

	1-pole	2-pole
Without illumination	<b>ABT</b>	<b>ABD</b>
With illumination	220...240 V <b>A12</b>	<b>A32</b>
	110...120 V <b>A14</b>	<b>A34</b>

Configuration code (Order example)

Type	Configuration code TA45
6145 -	A B T W F 1 5 0 C 0 - 0 0 0

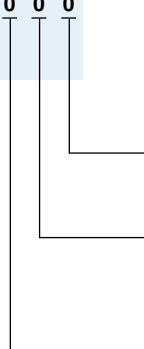

**Terminal PE**

1 Quick-connect terminal 6.3x0.8 mm

**Terminal N**

1 Quick-connect terminals 6.3x0.8mm, without connection to TA45  
4 Connection to TA45 non insulated

**Terminal L**

1 Quick-connect terminals 6.3x0.8mm, without connection to TA45  
4 Connection to TA45 non insulated

Variants

Circuit Breakers				Connectors						
Rated	Rocker	Illumi-	Add-	Moun-	Panel	Pro-	V-Lock	Internally	Config.	Order

Availability for all products can be searched real-time: <https://www.schurter.com/en/Stock-Check/Stock-Check-SCHURTER>

**Packaging unit**      20 Pcs

Accessories

Description

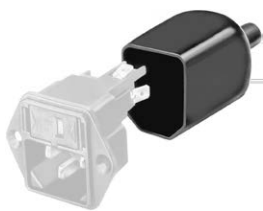

Assorted Covers  
Rear Cover

0859.0074

Mating Outlets/Connectors

Category / Description

Appliance Outlet Overview complete



4787, Mounting: Screw-on mounting, Appliance Outlet: IEC Solder terminals, 10 A, Suitable for appliances with protection class I      4787

4788, Mounting: Snap-in version, Appliance Outlet: IEC Solder terminals or quick connect terminals, 10 A, Suitable for appliances with protection class I      4788

IEC Appliance Outlet F or H, Screw-on Mounting, Front Side, Solder, PCB or Quick-connect Terminal      5091

[Appliance Outlet further types to 6145](#)



[Connector Overview complete](#)

4022 Mounting: Power Supply Cord, 3 x 1.5 mm <sup>2</sup> , Screw clamps, Connector: IEC C13	4022
4782 Mounting: Power Cord, 3 x 1 mm <sup>2</sup> / 3 x 18 AWG, Cable, Connector: IEC C13	4782
4012 Mounting: Power Supply Cord, 3 x 1 mm <sup>2</sup> , Screw clamps, Connector: IEC C13	4012
4785 Mounting: Power Cord, 3 x 1 mm <sup>2</sup> / 3 x 18 AWG, Cable, Connector: IEC C13	4785
4300-06 Mounting: Power Cord, 3 x 1 mm <sup>2</sup> / 3 x 18 AWG, Cable, Connector: IEC C13	4300-06
<a href="#">Connector further types to 6145</a>	...

### Mating Outlets/Connectors shuttered



[Power Cord Overview complete](#)

VAC17KS, V-Lock cord retaining, diverse m, Connector IEC C17, diverse, black / grey / white	VAC17KS
<a href="#">Power Cord further types to 6145</a>	

# Mouser Electronics

Authorized Distributor

Click to View Pricing, Inventory, Delivery & Lifecycle Information:

## Schurter:

[6145.0022.001](#) [6145.0024.001](#) [6145.0031.000](#) [6145.0031.001](#) [6145.0470.001](#) [6145.0586.001](#) [6145.0764.001](#)  
[6145.0847.001](#) [6145.0991.000](#) [6145.0991.001](#) [6145.1089.000](#) [6145.1089.001](#) [6145.1477.000](#) [6145.2078.001](#)  
[6145.2173.000](#) [6145.2173.001](#) [6145.2173.002](#) [6145.2217.001](#) [6145.2269.000](#) [6145.2405.001](#) [6145.2755.001](#)  
[6145.2770.000](#) [6145.2831.000](#) [6145.2837.000](#) [6145.2844.000](#) [6145.2882.001](#) [6145.2950.001](#) [6145.3213.001](#)  
[6145.3214.001](#) [6145.3431.001](#) [6145.3436.001](#) [6145.2307.001](#)