

SN75177B, SN75178B DIFFERENTIAL BUS REPEATERS

SLLS002C – D2606, JULY 1985 – REVISED FEBRUARY 1993

- Meets EIA Standards RS-422-A and RS-485 and CCITT Recommendations V.11 and X.27
- Designed for Multipoint Transmission on Long Bus Lines in Noisy Environments
- 3-State Outputs
- Bus Voltage Range . . . -7 V to 12 V
- Positive and Negative Current Limiting
- Driver Output Capability . . . 60 mA Max
- Driver Thermal Shutdown Protection
- Receiver Input Impedance . . . $12\text{ k}\Omega$ Min
- Receiver Input Sensitivity . . . $\pm 200\text{ mV}$
- Receiver Input Hysteresis . . . 50 mV Typ
- Operates From Single 5-V Supply
- Low Power Requirements

SN75177B . . . D OR P PACKAGE
(TOP VIEW)

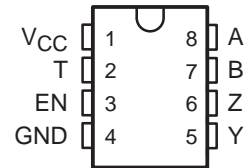

SN75178B . . . P PACKAGE
(TOP VIEW)

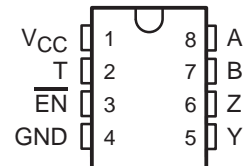

THE SN75177B IS NOT
RECOMMENDED FOR NEW DESIGN

description

The SN75177B and SN75178B differential bus repeaters are monolithic integrated devices each designed for one-way data communication on multipoint bus transmission lines. These devices are designed for balanced transmission bus line applications and meet EIA Standard RS-422-A and RS-485 and CCITT Recommendations V.11 and X.27. Each device is designed to improve the performance of the data communication over long bus lines. The SN75177B and SN75178B are identical except for the complementary enable inputs, which allow the devices to be used in pairs for bidirectional communication.

The SN75177B and SN75178B feature positive- and negative-current limiting 3-state outputs for the receiver and driver. The receiver features high input impedance, input hysteresis for increased noise immunity, and input sensitivity of $\pm 200\text{ mV}$ over a common-mode input voltage range of -7 V to 12 V . The driver features thermal shutdown for protection from line fault conditions. Thermal shutdown is designed to occur at a junction temperature of approximately 150°C . The driver is designed to drive current loads up to 60 mA maximum.

The SN75177B and SN75178B are designed for optimum performance when used on transmission buses employing the SN75172 and SN75174 differential line drivers, SN75173 and SN75175 differential line receivers, or SN75176B bus transceiver.

Function Tables

SN75177B

DIFFERENTIAL INPUTS A – B	ENABLE EN	OUTPUTS		
		T	Y	Z
$V_{ID} \geq 0.2\text{ V}$	H	H	H	L
$-0.2\text{ V} < V_{ID} < 0.2\text{ V}$	H	?	?	?
$V_{ID} \leq 0.2\text{ V}$	H	L	L	H
X	L	Z	Z	Z

SN75178B

DIFFERENTIAL INPUTS A – B	ENABLE $\overline{\text{EN}}$	OUTPUTS		
		T	Y	Z
$V_{ID} \geq 0.2\text{ V}$	L	H	H	L
$-0.2\text{ V} < V_{ID} < 0.2\text{ V}$	L	?	?	?
$V_{ID} \leq 0.2\text{ V}$	L	L	L	H
X	H	Z	Z	Z

H = high level, L = low level, ? = indeterminate, X = irrelevant, Z = impedance (off)

PRODUCTION DATA information is current as of publication date. Products conform to specifications per the terms of Texas Instruments standard warranty. Production processing does not necessarily include testing of all parameters.

TEXAS
INSTRUMENTS

POST OFFICE BOX 655303 • DALLAS, TEXAS 75265

Copyright © 1993, Texas Instruments Incorporated

SN75177B, SN75178B DIFFERENTIAL BUS REPEATERS

SLLS002C – D2606, JULY 1985 – REVISED FEBRUARY 1993

logic symbols†

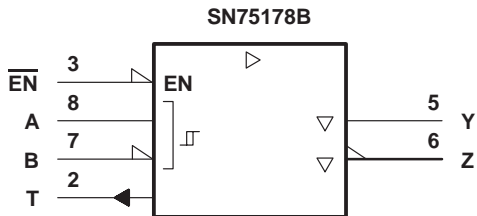
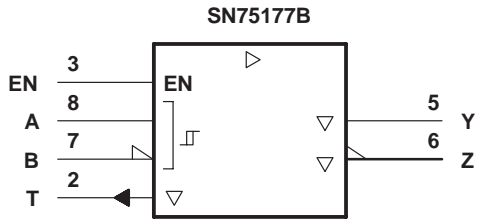

logic diagrams (positive logic)

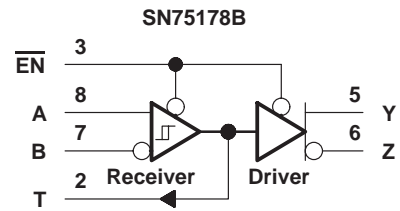
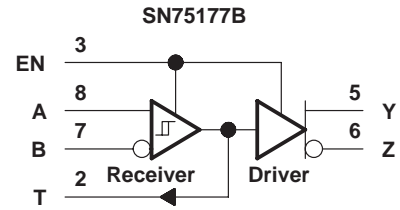

† These symbols are in accordance with ANSI/IEEE Std 91-1984 and IEC Publication 617-12.

schematics of inputs and outputs

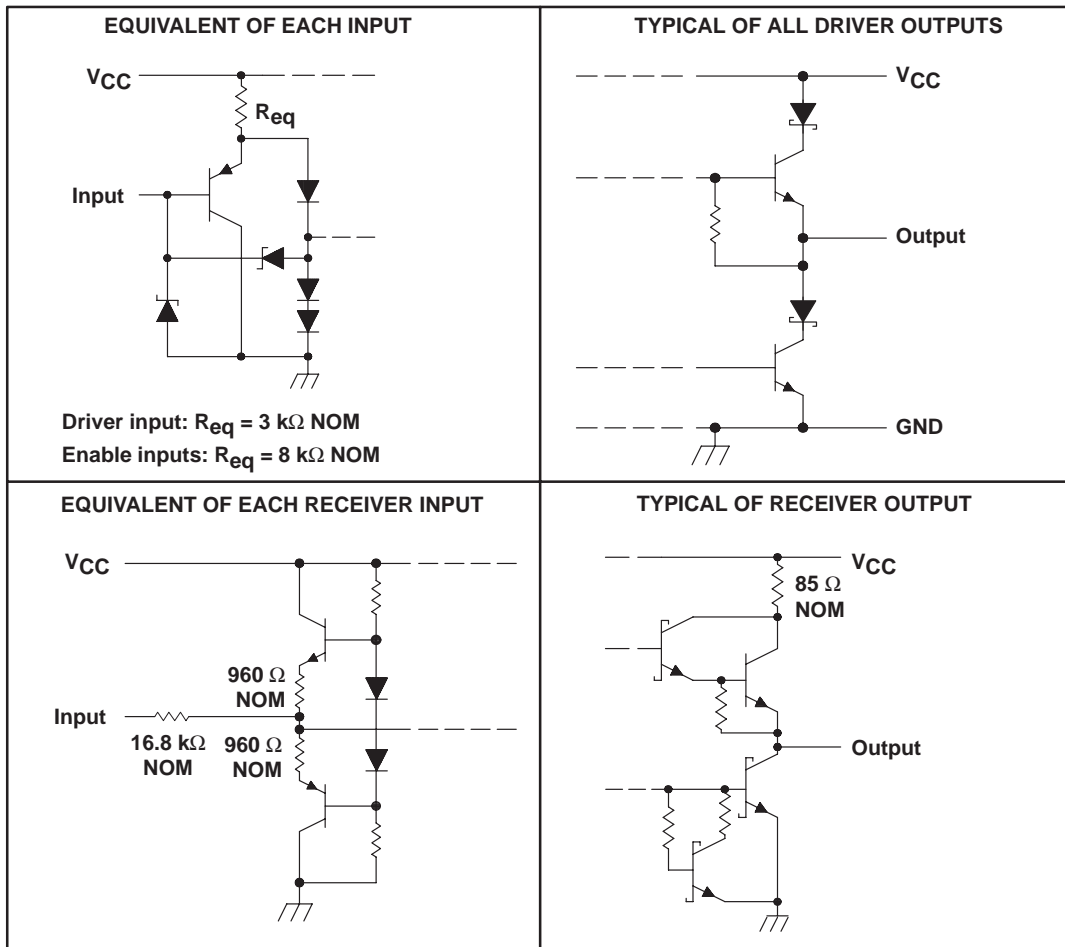

SN75177B, SN75178B DIFFERENTIAL BUS REPEATERS

SLLS002C – D2606, JULY 1985 – REVISED FEBRUARY 1993

absolute maximum ratings over operating free-air temperature range (unless otherwise noted)

Supply voltage, V_{CC} (see Note 1)	7 V
Voltage range at any bus terminal	–10 V to 15 V
Differential input voltage (see Note 2)	± 25 V
Enable input voltage	5.5 V
Continuous total dissipation	See Dissipation Rating Table
Operating free-air temperature range	0°C to 70°C
Storage temperature range	-65°C to 150°C
Lead temperature 1,6 mm (1/16 inch) from case for 10 seconds	260°C

- NOTES: 1. All voltage values, except differential input voltage, are with respect to network ground terminal.
 2. Differential input voltage is measured at the noninverting input with respect to the corresponding inverting input.

DISSIPATION RATING TABLE

PACKAGE	$T_A \leq 25^{\circ}\text{C}$ POWER RATING	DERATING FACTOR ABOVE $T_A = 25^{\circ}\text{C}$	$T_A = 70^{\circ}\text{C}$ POWER RATING
D	725 mW	5.8 mW/ $^{\circ}\text{C}$	464 mW
P	1000 mW	8.0 mW/ $^{\circ}\text{C}$	640 mW

recommended operating conditions

		MIN	NOM	MAX	UNIT
Supply voltage, V_{CC}		4.75	5	5.25	V
High-level input voltage, V_{IH}	EN or $\overline{\text{EN}}$	2			V
low-level input voltage, V_{IL}	EN or $\overline{\text{EN}}$			0.8	V
Common-mode input voltage, V_{IC}		-7^{\dagger}		12	V
Differential input voltage, V_{ID}				± 12	V
High-level output current, I_{OH}	Driver			–60	mA
	Receiver			–400	μA
Low-level output current, I_{OL}	Driver			60	mA
	Receiver			8	mA
Operating free-air temperature, T_A		0		70	$^{\circ}\text{C}$

\dagger The algebraic convention, where the less-positive (more-negative) limit is designated minimum, is used in this data sheet for common-mode input voltage and threshold voltage.

SN75177B, SN75178B DIFFERENTIAL BUS REPEATERS

SLLS002C – D2606, JULY 1985 – REVISED FEBRUARY 1993

DRIVER SECTION

electrical characteristics over recommended ranges of supply voltage and operating free-air temperature (unless otherwise noted)

PARAMETER	TEST CONDITIONS	MIN	TYP†	MAX	UNIT
V_{IK} Input clamp voltage	$I_I = -18 \text{ mA}$			-1.5	V
V_O Output voltage	$I_O = 0$	0		6	V
$ V_{OD1} $ Differential output voltage	$I_O = 0$	1.5		6	V
$ V_{OD2} $ Differential output voltage	$R_L = 100 \Omega$, See Figure 1	$1/2 V_{OD1}$ or $2 \S$			V
	$R_L = 54 \Omega$, See Figure 1	1.5	2.5	5	
$ V_{OD3} $ Differential output voltage	See Note 3	1.5		5	V
$\Delta V_{OD} $ Change in magnitude of differential output voltage‡	$R_L = 54 \Omega$ or 100Ω , See Figure 1			± 0.2	V
V_{OC} Common-mode output voltage				3 -1	V
$\Delta V_{OC} $ Change in magnitude of common-mode output voltage‡				± 0.2	V
I_O Output current	$V_{CC} = 0$, $V_O = -7 \text{ V to } 12 \text{ V}$			± 100	μA
I_{OZ} High-impedance-state output current	$V_O = -7 \text{ V to } 12 \text{ V}$			± 100	μA
I_{IH} High-level input current	$V_I = 2.4 \text{ V}$			20	μA
I_{IL} Low-level input current	$V_I = 0.4 \text{ V}$			-400	μA
I_{OS} Short-circuit output current	$V_O = -7 \text{ V}$			-250	mA
	$V_O = V_{CC}$			250	
	$V_O = 12 \text{ V}$			250	
I_{CC} Supply current (total package)	No load	Outputs enabled	57	70	mA
		Outputs disabled	26	35	

† All typical values are at $V_{CC} = 5 \text{ V}$ and $T_A = 25^\circ\text{C}$.

‡ $\Delta|V_{OD}|$ and $\Delta|V_{OC}|$ are the changes in magnitude of V_{OD} and V_{OC} , respectively, that occur when the input is changed from a high level to a low level.

§ The minimum V_{OD2} with a $100\text{-}\Omega$ load is either $1/2 V_{OD1}$ or 2, whichever is greater.

NOTE 3: See Figure 3.5 of EIA Standard RS-485.

switching characteristics, $V_{CC} = 5 \text{ V}$, $T_A = 25^\circ\text{C}$

PARAMETER	TEST CONDITIONS	MIN	TYP	MAX	UNIT
t_{dD} Differential-output delay time	$R_L = 54 \Omega$, See Figure 3		15	20	ns
t_{tD} Differential-output transition time			20	30	ns
t_{PZH} Output enable time to high level	$R_L = 110 \Omega$, See Figure 4		85	120	ns
t_{PZL} Output enable time to low level	$R_L = 110 \Omega$, See Figure 5		40	60	ns
t_{PHZ} Output disable time from high level	$R_L = 110 \Omega$, See Figure 4		150	250	ns
t_{PLZ} Output disable time from low level	$R_L = 110 \Omega$, See Figure 5		20	30	ns

SN75177B, SN75178B DIFFERENTIAL BUS REPEATERS

SLLS002C – D2606, JULY 1985 – REVISED FEBRUARY 1993

SYMBOL EQUIVALENTS

DATA SHEET PARAMETER	RS-422-A	RS-485
V_O	V_{oa}, V_{ob}	V_{oa}, V_{ob}
$ V_{OD1} $	V_o	V_o
$ V_{OD2} $	$V_t (R_L = 100 \Omega)$	$V_t (R_L = 54 \Omega)$
$ V_{OD3} $		V_t (Test Termination Measurement 2)
$\Delta V_{OD} $	$ V_t - \bar{V}_t $	$ V_t - \bar{V}_t $
V_{OC}	$ V_{OS} $	$ V_{OS} $
$\Delta V_{OC} $	$ V_{OS} - \bar{V}_{OS} $	$ V_{OS} - \bar{V}_{OS} $
I_{OS}	$ I_{sa} , I_{sb} $	
I_O	$ I_{xa} , I_{xb} $	I_{ia}, I_{ib}

RECEIVER SECTION

electrical characteristics over recommended ranges of common-mode input voltage, supply voltage, and operating free-air temperature (unless otherwise noted)

PARAMETER	TEST CONDITIONS	MIN	TYP†	MAX	UNIT
V_{T+} Positive-going input threshold voltage	$V_O = 2.7$ V, $I_O = -0.4$ mA			0.2	V
V_{T-} Negative-going input threshold voltage	$V_O = 0.5$ V, $I_O = 8$ mA	-0.2‡			V
V_{hys} Input hysteresis ($V_{T+} - V_{T-}$)			50		mV
V_{IK} Input clamp voltage at EN	$I_I = -18$ mA			-1.5	V
V_{OH} High-level output voltage	$V_{ID} = 200$ mV, See Figure 2, $I_{OH} = -400$ μ A		2.7		V
V_{OL} Low-level output voltage	$V_{ID} = -200$ mV, See Figure 2, $I_{OL} = 8$ mA			0.45	V
I_{OZ} High-impedance-state output current	$V_O = 0.4$ V to 2.4 V			20	μ A
				-400	
I_I Line input current	Other input at 0 V, See Note 4	$V_I = 12$ V		1	mA
		$V_I = -7$ V		-0.8	
I_{IH} High-level enable-input current	$V_{IH} = 2.7$ V			20	μ A
I_{IL} Low-level enable-input current	$V_{IL} = 0.4$ V			-200	μ A
r_i Input resistance			12		k Ω
I_{OS} Short-circuit output current		-15		-85	mA
I_{CC} Supply current (total package)	No load	Outputs enabled	57	70	mA
		Outputs disabled	26	35	

† All typical values are at $V_{CC} = 5$ V, $T_A = 25^\circ$ C.

‡ The algebraic convention, where the less-positive (more-negative) limit is designated minimum, is used in this data sheet for common-mode input voltage and threshold voltage levels only.

NOTE 4: Refer to EIA Standard RS-422 for exact conditions.

switching characteristics, $V_{CC} = 5$ V, $T_A = 25^\circ$ C

PARAMETER	TEST CONDITIONS	MIN	TYP	MAX	UNIT
t_{PLH} Propagation delay time, low-to-high level output	$V_{ID} = -1.5$ V to 1.5 V, $C_L = 15$ pF, See Figure 6		19	35	ns
t_{PHL} Propagation delay time, high-to-low level output			30	40	
t_{PZH} Output enable time to high level	$C_L = 15$ pF, See Figure 7		10	20	ns
t_{PZL} Output enable time to high level			12	20	
t_{PHZ} Output disable time from high level	$C_L = 15$ pF, See Figure 8		25	35	ns
t_{PLZ} Output disable time from low level			17	25	



SN75177B, SN75178B DIFFERENTIAL BUS REPEATERS

SLLS002C – D2606, JULY 1985 – REVISED FEBRUARY 1993

PARAMETER MEASUREMENT INFORMATION

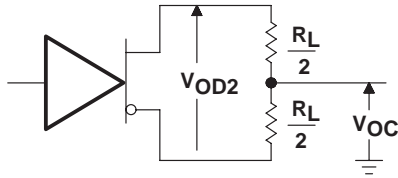

Figure 1. Driver V_{OD} and V_{OC}

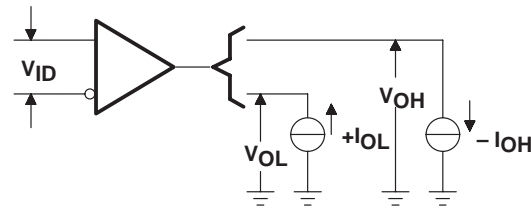
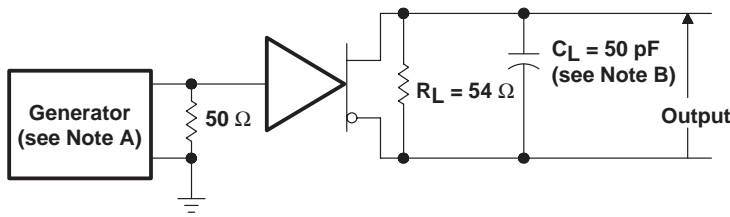
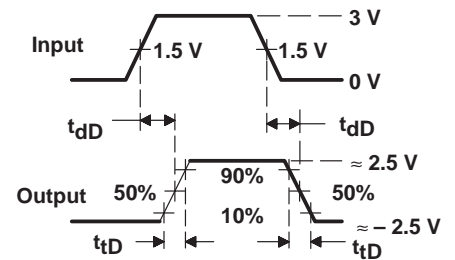

Figure 2. Receiver V_{OH} and V_{OL}



TEST CIRCUIT



VOLTAGE WAVEFORMS

Figure 3. Driver Differential-Output Test Circuit and Voltage Waveforms

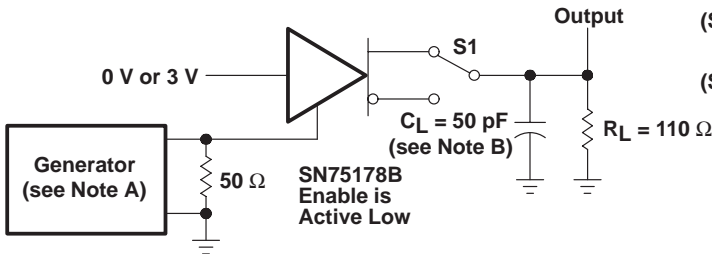

TEST CIRCUIT

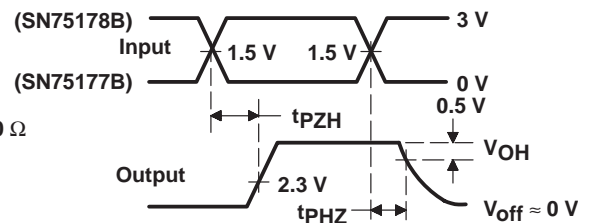

VOLTAGE WAVEFORMS

Figure 4. Driver Enable and Disable Times

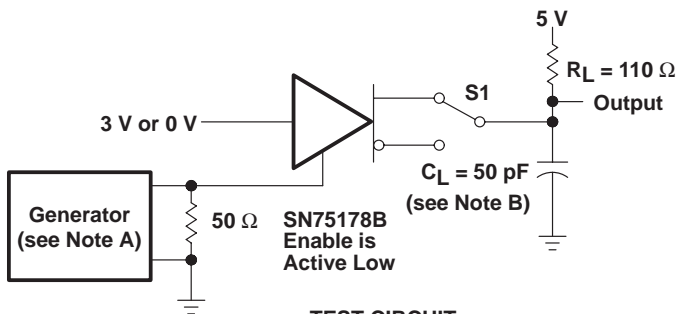

TEST CIRCUIT

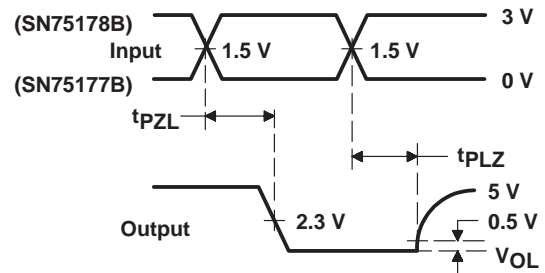

VOLTAGE WAVEFORMS

Figure 5. Driver Enable and Disable Times

NOTES: A. The input pulse is supplied by a generator having the following characteristics: PRR \leq 1 MHz, 50% duty cycle, $t_r \leq$ 6 ns, $t_f \leq$ 6 ns, $Z_0 = 50 \Omega$.

B. C_L includes probe and jig capacitance.

PARAMETER MEASUREMENT INFORMATION

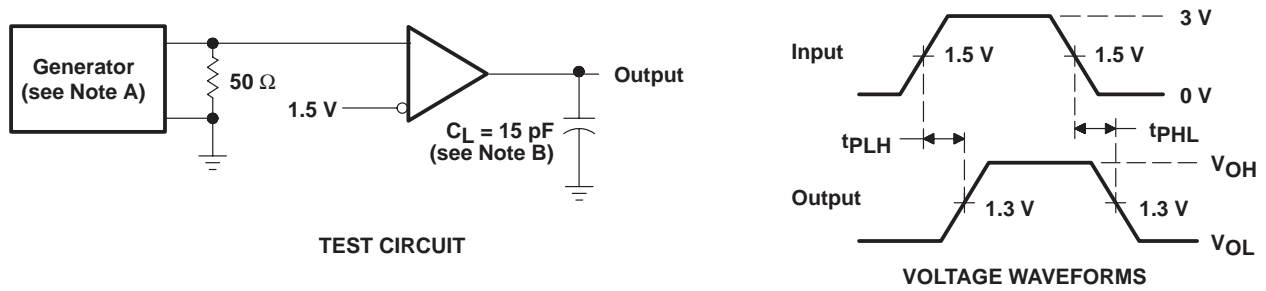

Figure 6. Receiver Propagation Delay Times

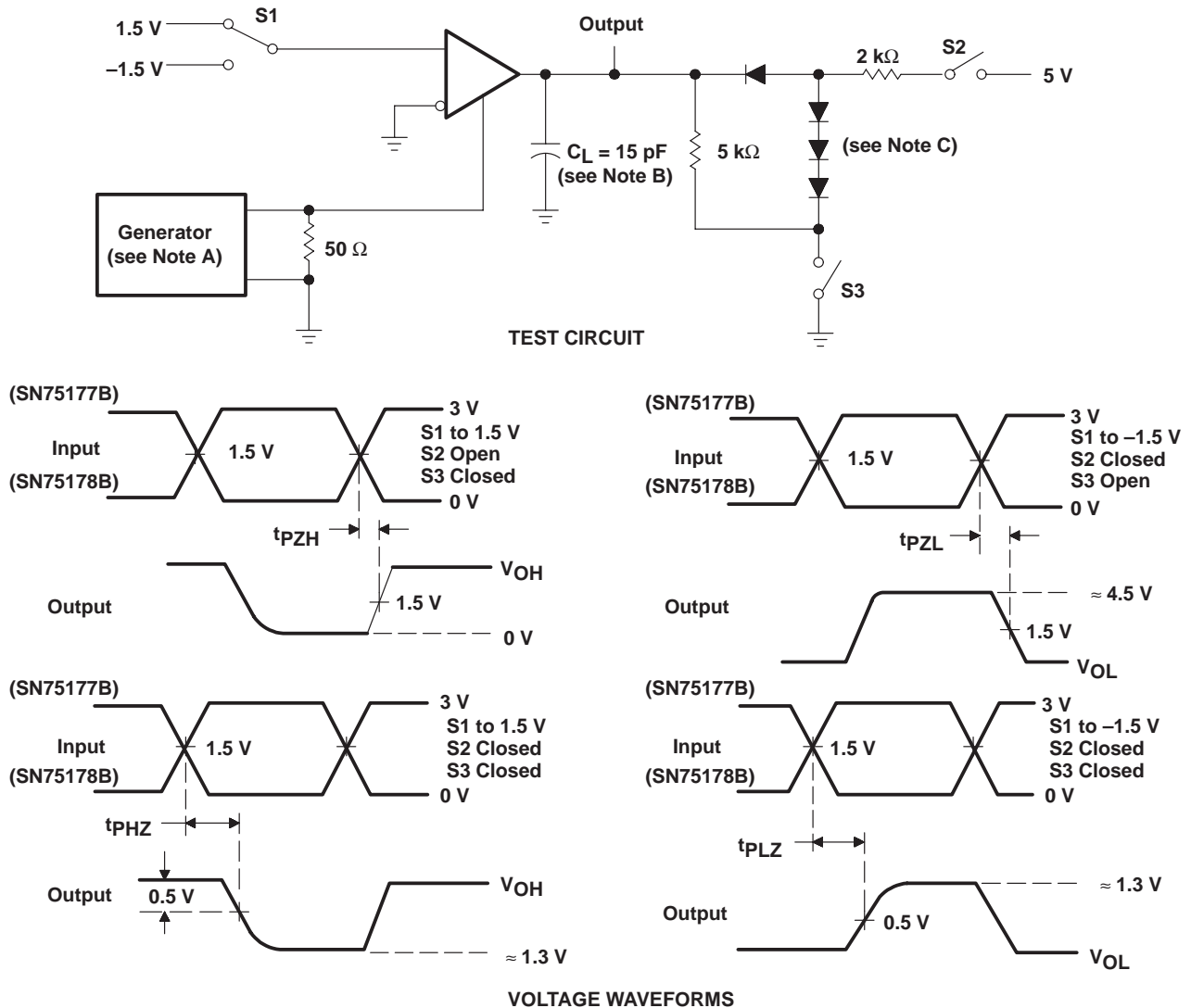

Figure 7. Receiver Output Enable and Disable Times

- NOTES: A. The input pulse is supplied by a generator having the following characteristics: PRR \leq 1 MHz, 50% duty cycle, $t_r \leq$ 6 ns, $t_f \leq$ 6 ns, $Z_0 = 50 \Omega$.
 B. C_L includes probe and jig capacitance.
 C. All diodes are 1N916 or equivalent.

SN75177B, SN75178B DIFFERENTIAL BUS REPEATERS

SLLS002C – D2606, JULY 1985 – REVISED FEBRUARY 1993

TYPICAL CHARACTERISTICS

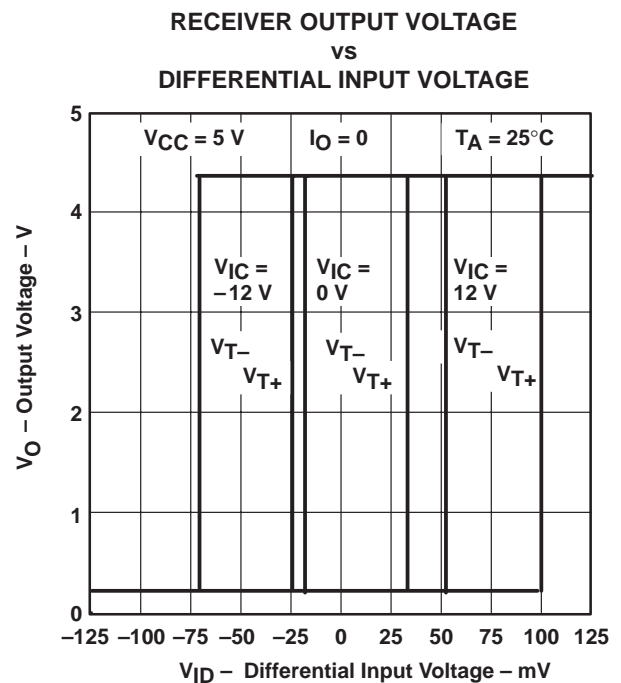
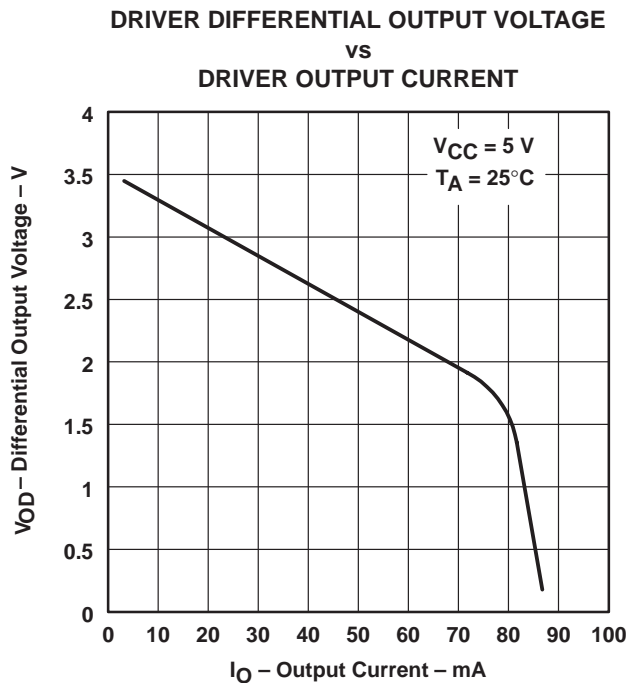
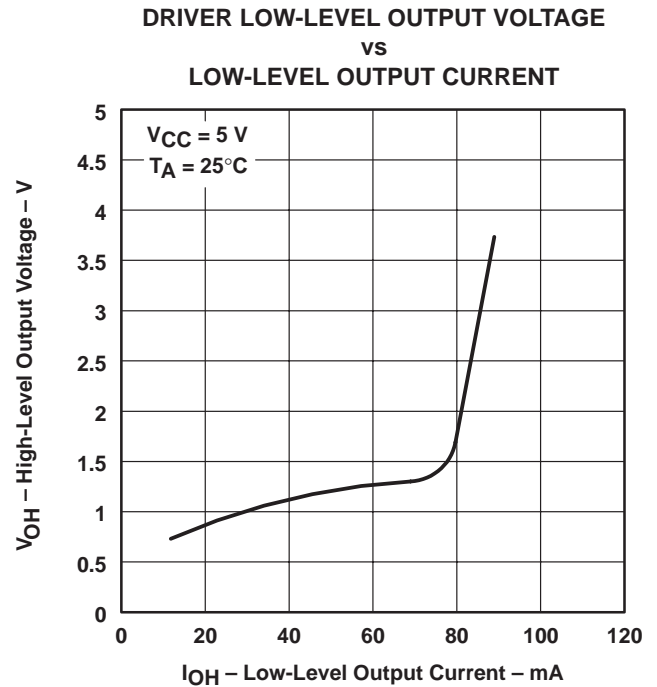
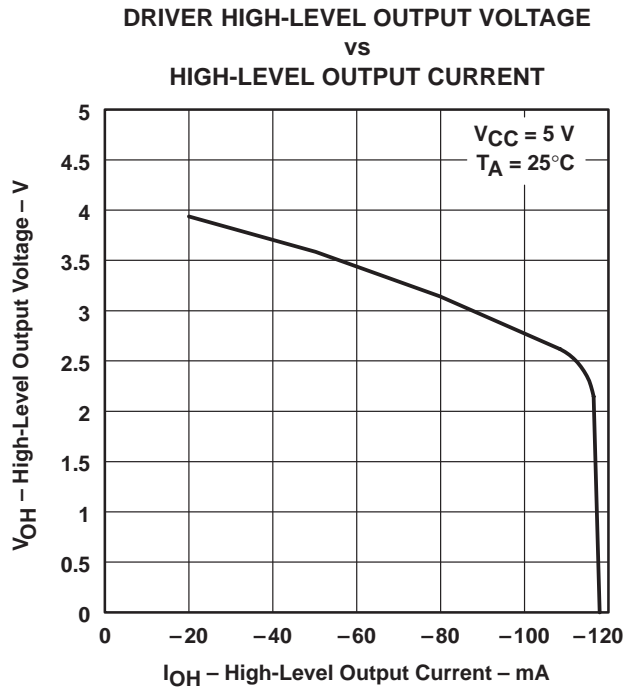

TYPICAL CHARACTERISTICS

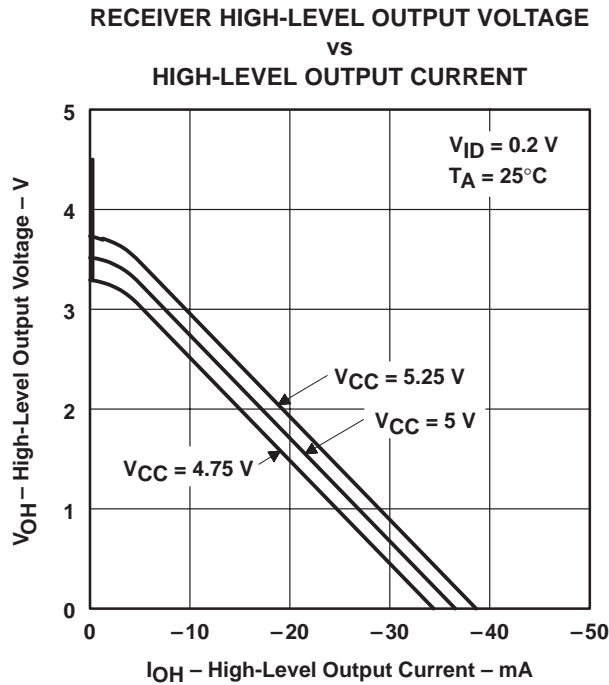

Figure 12

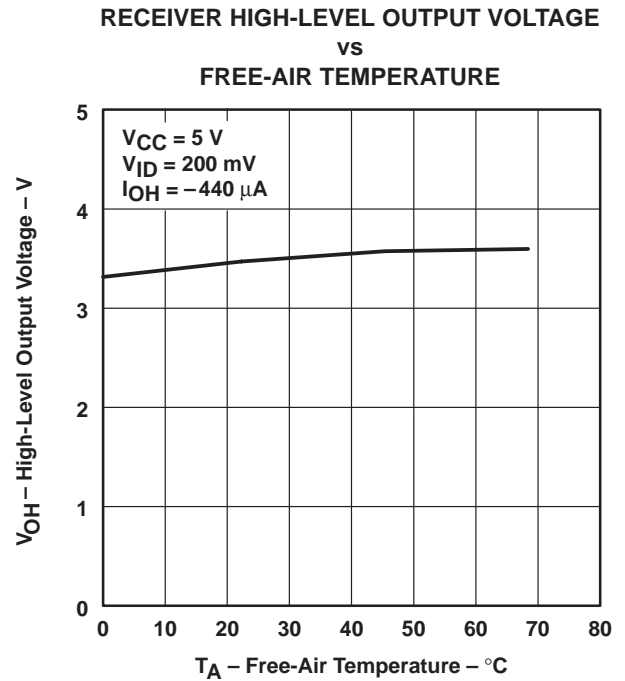

Figure 13

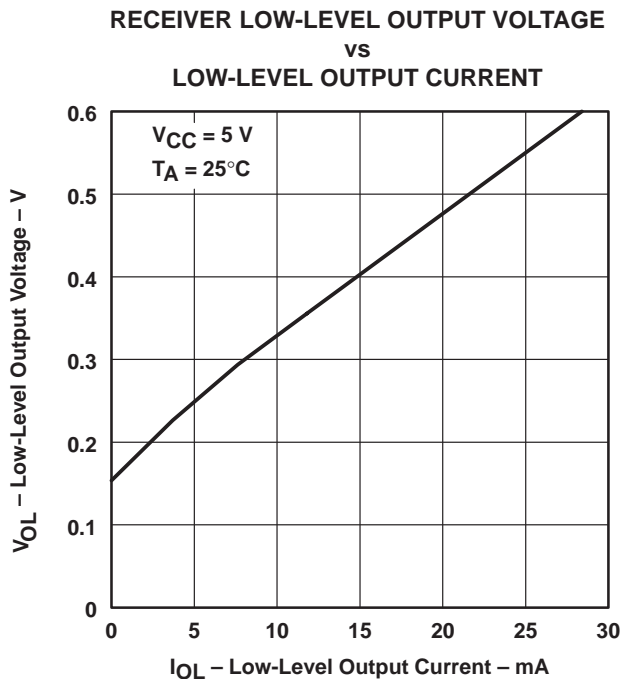

Figure 14

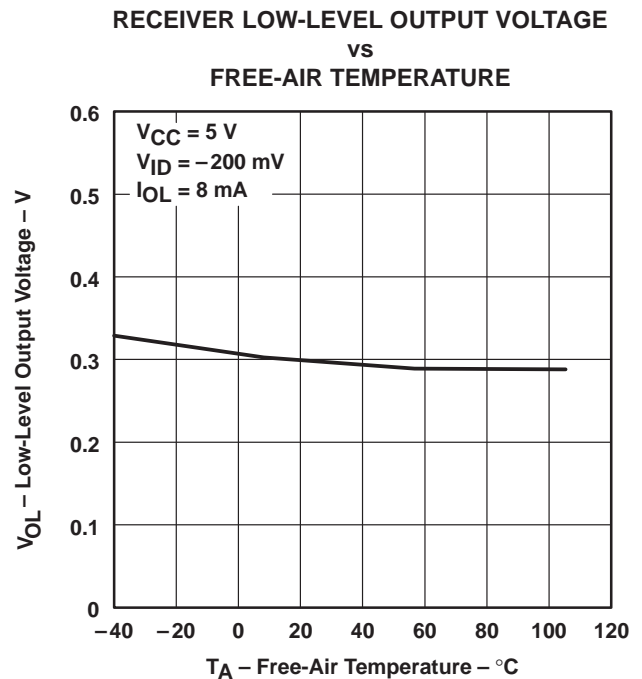
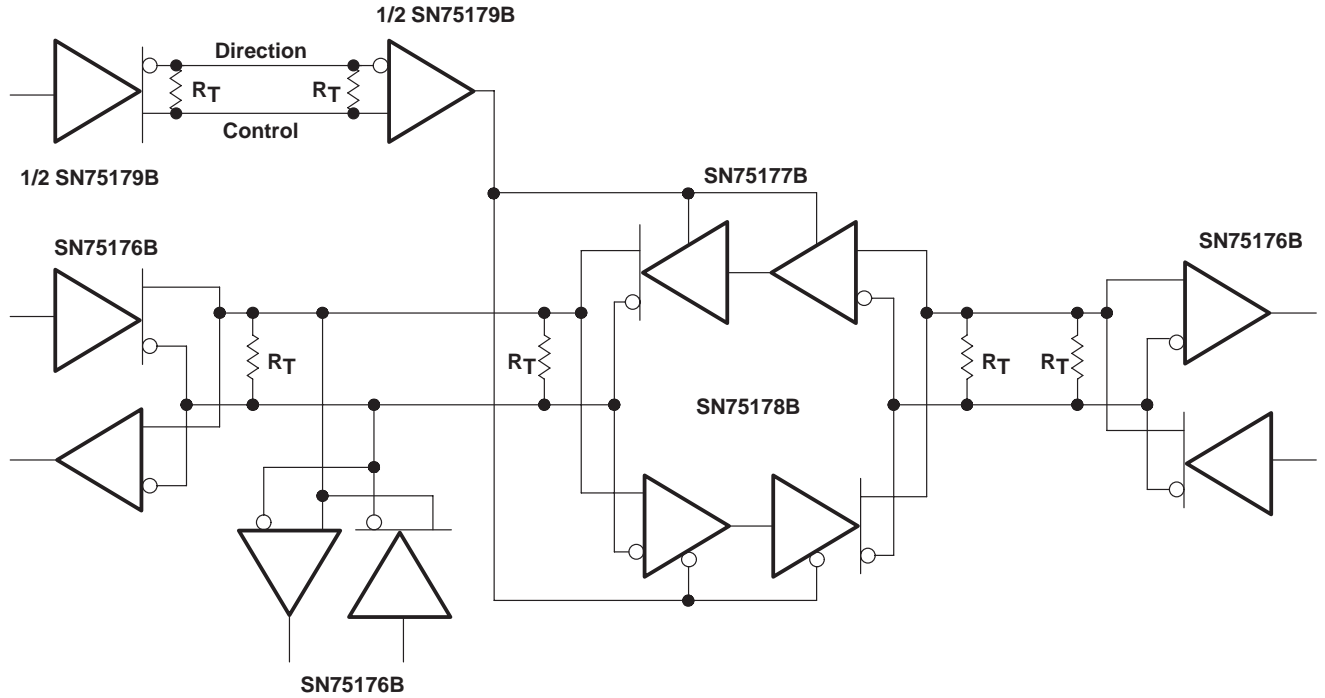

Figure 15

SN75177B, SN75178B DIFFERENTIAL BUS REPEATERS

SLLS002C – D2606, JULY 1985 – REVISED FEBRUARY 1993

APPLICATION INFORMATION



NOTE: The line should be terminated at both ends in its characteristic impedance. Stub lengths off the main line should be kept as short as possible.

Figure 16. Typical Application Circuit

PACKAGING INFORMATION

Orderable Device	Status (1)	Package Type	Package Drawing	Pins	Package Qty	Eco Plan (2)	Lead/Ball Finish (6)	MSL Peak Temp (3)	Op Temp (°C)	Device Marking (4/5)	Samples
SN75178BP	ACTIVE	PDIP	P	8	50	Green (RoHS & no Sb/Br)	NIPDAU	N / A for Pkg Type	0 to 70	SN75178BP	Samples

(1) The marketing status values are defined as follows:

ACTIVE: Product device recommended for new designs.

LIFEBUY: TI has announced that the device will be discontinued, and a lifetime-buy period is in effect.

NRND: Not recommended for new designs. Device is in production to support existing customers, but TI does not recommend using this part in a new design.

PREVIEW: Device has been announced but is not in production. Samples may or may not be available.

OBSOLETE: TI has discontinued the production of the device.

(2) **RoHS:** TI defines "RoHS" to mean semiconductor products that are compliant with the current EU RoHS requirements for all 10 RoHS substances, including the requirement that RoHS substance do not exceed 0.1% by weight in homogeneous materials. Where designed to be soldered at high temperatures, "RoHS" products are suitable for use in specified lead-free processes. TI may reference these types of products as "Pb-Free".

RoHS Exempt: TI defines "RoHS Exempt" to mean products that contain lead but are compliant with EU RoHS pursuant to a specific EU RoHS exemption.

Green: TI defines "Green" to mean the content of Chlorine (Cl) and Bromine (Br) based flame retardants meet JS709B low halogen requirements of <=1000ppm threshold. Antimony trioxide based flame retardants must also meet the <=1000ppm threshold requirement.

(3) MSL, Peak Temp. - The Moisture Sensitivity Level rating according to the JEDEC industry standard classifications, and peak solder temperature.

(4) There may be additional marking, which relates to the logo, the lot trace code information, or the environmental category on the device.

(5) Multiple Device Markings will be inside parentheses. Only one Device Marking contained in parentheses and separated by a "~" will appear on a device. If a line is indented then it is a continuation of the previous line and the two combined represent the entire Device Marking for that device.

(6) Lead/Ball Finish - Orderable Devices may have multiple material finish options. Finish options are separated by a vertical ruled line. Lead/Ball Finish values may wrap to two lines if the finish value exceeds the maximum column width.

Important Information and Disclaimer:The information provided on this page represents TI's knowledge and belief as of the date that it is provided. TI bases its knowledge and belief on information provided by third parties, and makes no representation or warranty as to the accuracy of such information. Efforts are underway to better integrate information from third parties. TI has taken and continues to take reasonable steps to provide representative and accurate information but may not have conducted destructive testing or chemical analysis on incoming materials and chemicals. TI and TI suppliers consider certain information to be proprietary, and thus CAS numbers and other limited information may not be available for release.

In no event shall TI's liability arising out of such information exceed the total purchase price of the TI part(s) at issue in this document sold by TI to Customer on an annual basis.

IMPORTANT NOTICE AND DISCLAIMER

TI PROVIDES TECHNICAL AND RELIABILITY DATA (INCLUDING DATASHEETS), DESIGN RESOURCES (INCLUDING REFERENCE DESIGNS), APPLICATION OR OTHER DESIGN ADVICE, WEB TOOLS, SAFETY INFORMATION, AND OTHER RESOURCES "AS IS" AND WITH ALL FAULTS, AND DISCLAIMS ALL WARRANTIES, EXPRESS AND IMPLIED, INCLUDING WITHOUT LIMITATION ANY IMPLIED WARRANTIES OF MERCHANTABILITY, FITNESS FOR A PARTICULAR PURPOSE OR NON-INFRINGEMENT OF THIRD PARTY INTELLECTUAL PROPERTY RIGHTS.

These resources are intended for skilled developers designing with TI products. You are solely responsible for (1) selecting the appropriate TI products for your application, (2) designing, validating and testing your application, and (3) ensuring your application meets applicable standards, and any other safety, security, or other requirements. These resources are subject to change without notice. TI grants you permission to use these resources only for development of an application that uses the TI products described in the resource. Other reproduction and display of these resources is prohibited. No license is granted to any other TI intellectual property right or to any third party intellectual property right. TI disclaims responsibility for, and you will fully indemnify TI and its representatives against, any claims, damages, costs, losses, and liabilities arising out of your use of these resources.

TI's products are provided subject to TI's Terms of Sale (www.ti.com/legal/termsofsale.html) or other applicable terms available either on ti.com or provided in conjunction with such TI products. TI's provision of these resources does not expand or otherwise alter TI's applicable warranties or warranty disclaimers for TI products.

Mailing Address: Texas Instruments, Post Office Box 655303, Dallas, Texas 75265
Copyright © 2020, Texas Instruments Incorporated