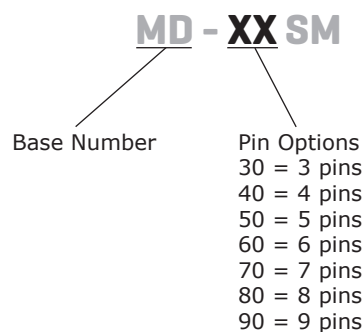

SERIES: MD-SM | **DESCRIPTION:** MINI DIN CONNECTOR**FEATURES**

- PCB mount
- right angle
- side shielded

**PART NUMBER KEY****SPECIFICATIONS**

parameter	conditions/description	min	typ	max	units
rated input voltage			30		Vdc
rated input current				1	A
contact resistance				30	mΩ
insulation resistance		1000			MΩ
voltage withstand	for 1 minute			500	Vac
insertion force				45	N
withdrawal force		7			N
operating temperature		-25		50	°C
life			500		cycles
flammability rating	UL94V-0				
RoHS	yes				

SOLDERABILITY

parameter	conditions/description	min	typ	max	units
hand soldering	for 1~3 seconds	230		250	°C

MECHANICAL DRAWINGS (MD-30SM, MD-40SM, MD-50SM)

units: mm
 tolerance:
 X.X ±0.38 mm
 X.XX ±0.25 mm
 X.XXX ±0.13 mm

	MATERIAL	PLATING
body	PBT+30%GF (UL94V-0)	
pins	brass	tin
shield	brass	nickel



MD-30SM

MD-40SM

MD-50SM

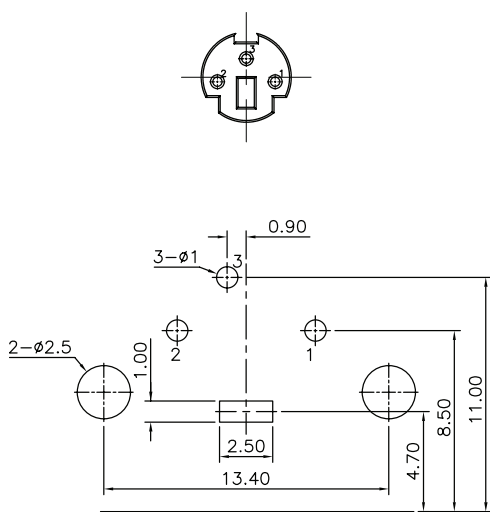

Recommended PCB Layout
Top View

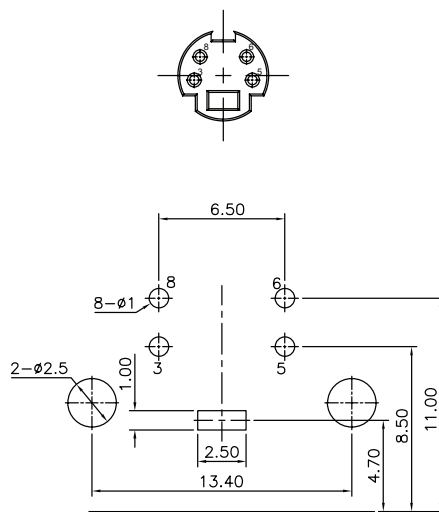

Recommended PCB Layout
Top View

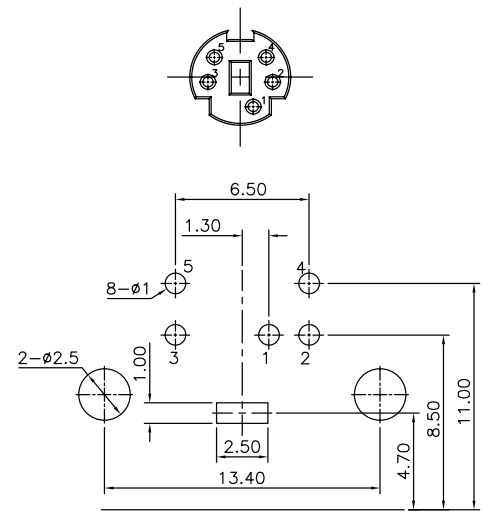

Recommended PCB Layout
Top View

MECHANICAL DRAWINGS (MD-60SM, MD-70SM, MD-80SM)

units: mm
 tolerance:
 X.X ±0.38 mm
 X.XX ±0.25 mm
 X.XXX ±0.13 mm

	MATERIAL	PLATING
body	PBT+30%GF (UL94V-0)	
pins	brass	tin
shield	brass	nickel

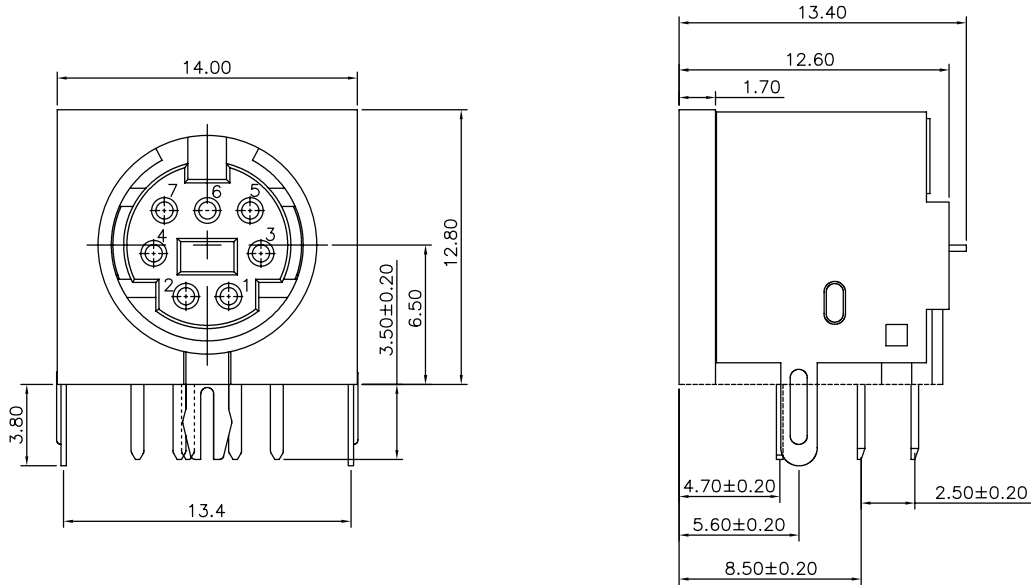

MD-60SM

MD-70SM

MD-80SM

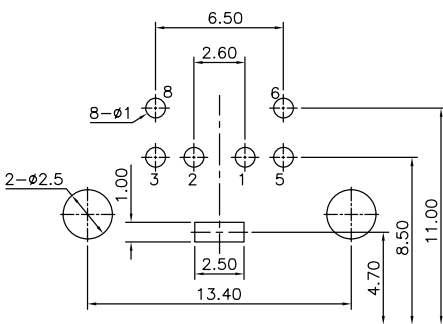
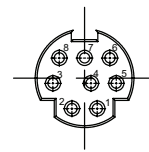
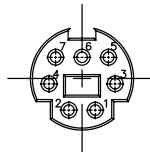
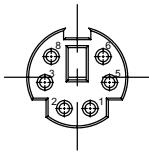

Recommended PCB Layout
Top View

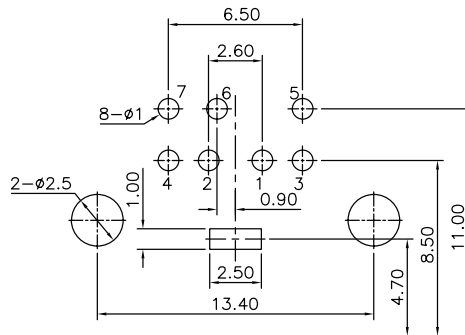

Recommended PCB Layout
Top View

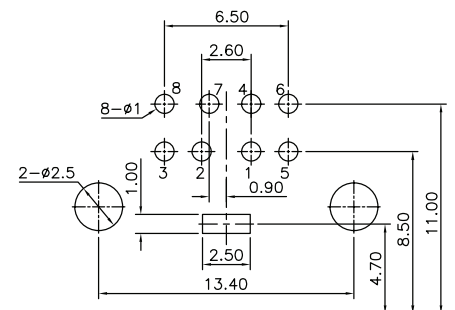

Recommended PCB Layout
Top View

MECHANICAL DRAWING (MD-90SM)

units: mm
 tolerance:
 X.X ±0.35 mm
 X.XX ±0.25 mm
 X.XXX ±0.15 mm

	MATERIAL	PLATING
body	PBT (UL94V-0)	
cover	PBT (UL94V-0)	
ground	brass	tin
pins	brass	tin
shield	brass	tin

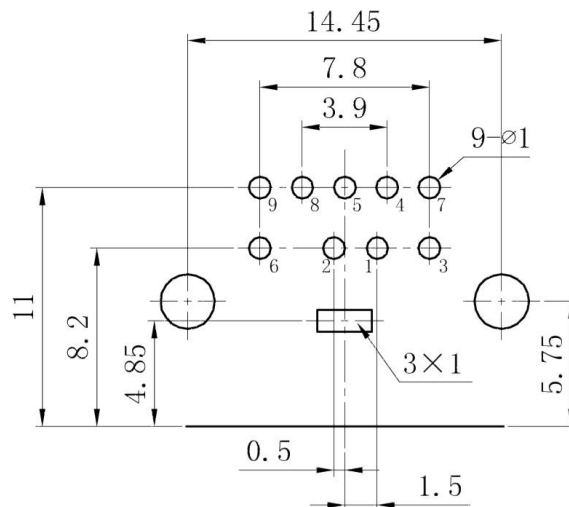
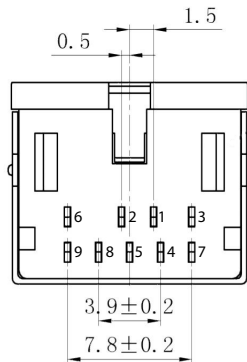
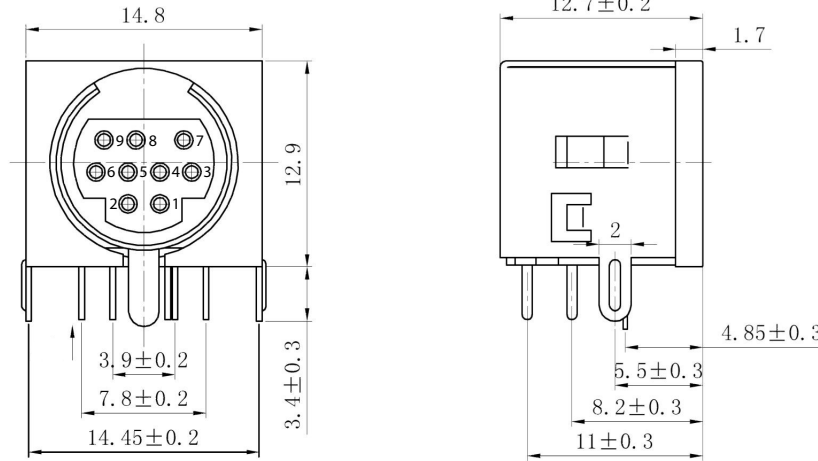

Recommended PCB Layout
 Top View

REVISION HISTORY

rev.	description	date
1.0	initial release	02/23/2006
1.01	new template applied	02/22/2012
1.02	updated datasheet	08/25/2017
1.03	added hand soldering details	01/19/2018
1.04	updated housing, brand update	11/21/2019
1.05	updated PCB footprints	08/11/2020

The revision history provided is for informational purposes only and is believed to be accurate.

CUI DEVICES

CUI Devices offers a one (1) year limited warranty. Complete warranty information is listed on our website.

CUI Devices reserves the right to make changes to the product at any time without notice. Information provided by CUI Devices is believed to be accurate and reliable. However, no responsibility is assumed by CUI Devices for its use, nor for any infringements of patents or other rights of third parties which may result from its use.

CUI Devices products are not authorized or warranted for use as critical components in equipment that requires an extremely high level of reliability. A critical component is any component of a life support device or system whose failure to perform can be reasonably expected to cause the failure of the life support device or system, or to affect its safety or effectiveness.